

# Compaq Enterprise Directory for eBusiness

---

## Management

Revision/Update Information: Version 5.0

---

**February 2001**

© 2000 Compaq Computer Corporation.

Compaq, the Compaq logo, DIGITAL and the Digital logo Registered in US Patent and Trademark Office. Tru64 is a trademark of Compaq Information Technologies Group, L.P. in the United States and other countries. Other trademarks of Compaq are: ALL-IN-1, DEC, DECnet, DECwindows, MAILbus 400, OpenVMS, OSAK, VAX, VAXcluster, VAX DOCUMENT, VMS.

Microsoft, Windows and Windows NT are trademarks of Microsoft Corporation in the United States and other countries. Intel is a registered trademark of Intel Corporation. UNIX is a trademark of The Open Group in the United States and other countries.

Internet is a registered trademark of Internet, Inc. OSF and OSF/1 are trademarks of Open Software Foundation, Inc. OSI is a registered trademark of CA Management, Inc. X/Open is a trademark of the X/Open Company Ltd.

All other product names mentioned herein may be trademarks of their respective companies.

Confidential computer software. Valid license from Compaq required for possession, use or copying. Consistent with FAR 12.211 and 12.212, Commercial Computer Software, Computer Software Documentation, and Technical Data for Commercial Items are licensed to the US. Government under vendor's standard commercial license.

Compaq shall not be liable for technical or editorial errors or omissions contained herein. The information in this document is provided "as is" without warranty of any kind and is subject to change without notice. The warranties for Compaq products are set forth in the express limited warranty statements accompanying such products. Nothing herein should be construed as constituting an additional warranty.

Compaq believes the information in this publication is accurate as of its publication date; such information is subject to change without notice. Compaq is not responsible for any inadvertent errors. Compaq conducts its business in a manner that conserves the environment and protects the safety and health of its employees, customers and the community.

---

# Contents

<b>Preface</b> .....	xvii
----------------------	------

## Part I Introduction

### 1 Directory Information and Enterprise Directories

1.1	Directory Information .....	1-1
1.1.1	Entries .....	1-2
1.1.1.1	Attributes .....	1-3
1.1.2	Entry Names .....	1-3
1.1.2.1	Distinguished Names .....	1-4
1.1.2.2	Alias Names .....	1-5
1.1.3	Classes .....	1-6
1.1.3.1	Mandatory Attributes .....	1-6
1.1.3.2	Optional Attributes .....	1-6
1.1.3.3	Name Forms .....	1-6
1.1.3.4	Structure Rules .....	1-7
1.2	Enterprise Directories .....	1-8
1.2.1	The Schema .....	1-9
1.2.2	Distributing Directory Information .....	1-9
1.2.3	Replicating Directory Information .....	1-10
1.2.4	Distributing Requests for Information .....	1-11
1.2.5	Controlling Access to Directory Entries .....	1-12
1.2.6	Accounting for Enterprise Directory Use .....	1-12
1.3	Managing the Compaq Enterprise Directory for eBusiness Product .....	1-12
1.3.1	Managing Directory Information .....	1-12
1.3.2	Managing the Enterprise Directory .....	1-13

### 2 Single Node X.500 Implementation Tutorial

2.1	Install the Product .....	2-2
2.2	Configure the DSA .....	2-2
2.3	Configure Application Defaults .....	2-3
2.4	Create Some Directory Entries .....	2-3
2.5	Experiment with the Example Enterprise Directory .....	2-3
2.6	Destroy the Example Enterprise Directory .....	2-4

### 3 Multi-Node X.500 Implementation Tutorial

3.1	The Characteristics of the Example Enterprise Directory . . . . .	3-2
3.2	Install the Product . . . . .	3-2
3.3	Run the DSA Configuration Utility on Both Systems . . . . .	3-4
3.4	Complete the Configuration for CN=DSA1 . . . . .	3-5
3.4.1	Notes About the Configuration of CN=DSA1 . . . . .	3-6
3.5	Complete the Configuration for CN=DSA2 . . . . .	3-7
3.5.1	Notes About the Configuration of CN=DSA2 . . . . .	3-8
3.6	Configure Application Defaults on Both Systems . . . . .	3-9
3.6.1	Configure Lookup Client Defaults on Both Systems . . . . .	3-9
3.7	Create Some Entries . . . . .	3-10
3.8	Summary of the Tasks Completed So Far . . . . .	3-12
3.9	Setting Up Access Controls . . . . .	3-13
3.10	Replicating Information Between the Two DSAs . . . . .	3-15
3.11	Experimenting with the Example Enterprise Directory . . . . .	3-18
3.12	Using the Lookup Client . . . . .	3-21
3.13	Deleting the Example Enterprise Directory . . . . .	3-22

## Part II Planning

### 4 Planning Your Directory Information Tree

4.1	DIT Planning Considerations . . . . .	4-5
4.1.1	Representing Hierarchy as Attributes of an Entry . . . . .	4-9
4.2	Choosing Classes to Represent Objects . . . . .	4-10
4.3	Positioning Your Directory Information Tree into a Global Context . . . . .	4-13
4.4	Naming Your Entries . . . . .	4-15
4.4.1	Resolving Naming Clashes . . . . .	4-16
4.5	Planning Entries to Represent DSAs . . . . .	4-18
4.5.1	Recommended Position of DSA Entries in Your DIT . . . . .	4-19

### 5 Planning DSAs to Hold Your Directory Information Tree

5.1	Dividing Your Directory Information Tree into Naming Contexts . . . . .	5-3
5.1.1	Implementing Your DIT as One Naming Context . . . . .	5-3
5.1.2	Implementing Your DIT as Several Naming Contexts . . . . .	5-3
5.1.3	Assigning Names to Naming Contexts . . . . .	5-4
5.1.4	Distributing Naming Contexts . . . . .	5-5
5.1.5	Replicating Naming Contexts . . . . .	5-6
5.2	Planning DSA Configuration Information . . . . .	5-9
5.2.1	DSA AE Titles . . . . .	5-10
5.2.2	DSA Passwords . . . . .	5-10
5.2.3	DSA Presentation Addresses . . . . .	5-11
5.2.4	DSA LDAP Port . . . . .	5-11
5.2.5	Naming Context Entities . . . . .	5-11
5.2.5.1	Planning Primary and Secondary Consumer Information . . . . .	5-12
5.2.6	Subordinate Reference Entities . . . . .	5-14
5.2.6.1	Identifying Which DSAs Require Manually Created Subordinate References . . . . .	5-14
5.2.7	Superior Reference Entities . . . . .	5-16
5.2.8	Using the Worksheets . . . . .	5-17
5.2.9	Attributes of DSA Entries . . . . .	5-17
5.2.9.1	Planning the DXIM Command to Create DSA Entries . . . . .	5-18

## 6 Customizing the Schema

6.1	Schema Text Files	6-2
6.2	Compiling the Schema	6-5
6.3	Assigning Object Identifiers to New Definitions	6-7
6.4	Planning to Customize the Schema	6-8
6.5	Planning an Auxiliary Class	6-9
6.5.1	Defining an Auxiliary Class	6-11
6.5.2	DXIM Restrictions on the Use of Auxiliary Classes	6-12
6.5.3	Defining Attributes	6-12
6.5.3.1	Defining Primary and Secondary Attributes	6-14
6.5.4	Planning to Index Attribute Values	6-15
6.5.4.1	The Purpose of Indexes	6-15
6.5.4.2	Making a DSA Index a Given Attribute's Values	6-16
6.5.4.3	Notes About Indexing Attribute Values	6-17
6.6	Defining a Label	6-17
6.7	Planning a Structural Class	6-19
6.7.1	Defining a Structural Class	6-20
6.7.2	Defining Name Forms	6-22
6.7.3	Defining Structure Rules	6-23
6.7.3.1	Structure Rules for Entries Immediately Beneath the Root	6-23
6.7.3.2	Structure Rules for Entries Beneath Other Entries	6-24
6.7.3.3	Assigning Structure Rule Identifiers	6-25
6.7.3.4	Structure Rule Definitions: An Example	6-25
6.7.4	Defining Window Definitions	6-25
6.8	Planning Alias Classes	6-26
6.9	Defining Search Filters and Filter Fields for the Windows Utility	6-28
6.9.1	Search Filter Definitions	6-29
6.9.1.1	Customizing Search Filter Definitions	6-31
6.9.2	Filter Field Definitions	6-31
6.9.2.1	Customizing Filter Field Definitions	6-33

## 7 Controlling Access to Your Directory Information and Services

7.1	The Default Access Control	7-1
7.2	The Access Control Template File	7-1
7.3	Planning the Name of the Access Control Subentry	7-2
7.4	What the Access Control Template File Does	7-3
7.5	Customizing Access Controls	7-4
7.5.1	Access Controls Required for Normal Operation of the Enterprise Directory	7-5
7.5.2	Access Controls Required by Directory Information Managers	7-5
7.5.3	The Composition of Access Control Definitions	7-5
7.5.3.1	Specifying What Users an ACItem Applies To	7-6
7.5.3.2	Specifying What Information an ACItem Applies To	7-6
7.5.3.3	Specifying What Types of Request an ACItem Applies To	7-7
7.5.4	How ACItems are Ranked According to Precedence and Specificity	7-7
7.6	Access Control Scope and Inheritance	7-8
7.7	Alternative Method of Controlling Access to DSAs	7-10
7.7.1	Alternative Method of Configuring DSA Trust	7-10
7.7.2	Alternative Method of Configuring User Security	7-11

## Part III Set Up

### 8 Configuring DSAs

8.1	Notes on Configuring a DSA .....	8-2
8.1.1	Management Entities Must Be Created in Order of Superiority .....	8-2
8.1.2	Configuring Entities of Different Types with the Same Name .....	8-2
8.1.3	Configuring a DSA that Already Holds Information .....	8-2
8.1.4	Configuring a DSA Remotely .....	8-3
8.1.5	DSA Configuration Details are Permanent .....	8-3
8.1.6	NCL Command Line Help is Available Online .....	8-3
8.2	Running the DSA Configuration Utility .....	8-4
8.3	Creating DSAs .....	8-5
8.3.1	Setting DSA AE Titles .....	8-5
8.3.2	Setting DSA Passwords .....	8-6
8.3.3	Setting DSA Volatile Modifications .....	8-6
8.3.4	Setting DSA Presentation Addresses .....	8-6
8.3.5	Setting DSA LDAP Port .....	8-7
8.4	Creating a Naming Context Entity .....	8-7
8.4.1	Configuring Consumer Access Points on Naming Contexts .....	8-8
8.5	Creating a Subordinate Reference Entity .....	8-8
8.6	Creating a Superior Reference Entity .....	8-9
8.7	Enabling DSAs .....	8-10
8.8	Creating Directory Entries to Represent Your DSAs .....	8-10
8.9	Summary of Configuration .....	8-11
8.9.1	Examples of Configuring DSAs .....	8-11
8.10	Implementing Replication .....	8-13
8.10.1	Managing Shadowing Agreement Subentries .....	8-16
8.10.1.1	Notes About Modifying Shadowing Agreement Subentries .....	8-17
8.10.1.2	Identifying the Subentries for a Given Shadowing Agreement .....	8-17
8.10.1.3	Identifying the Initiator of Replication .....	8-18
8.10.1.4	Configuring the Replication Schedule .....	8-19
8.10.1.5	Forcing Replication to Happen Immediately .....	8-20
8.10.1.6	Configuring Replication to Occur Only When Information Changes .....	8-20
8.10.1.7	Configuring Replication Back to the Default Behaviour .....	8-20
8.10.2	Terminating Replication Agreements .....	8-21
8.11	Disabling DSAs .....	8-21
8.12	Deleting DSAs .....	8-22
8.13	Starting the DSA as Part of OpenVMS System Startup .....	8-22
8.14	Defragmenting the Memory Image File (Tru64 UNIX) .....	8-23

### 9 Configuring and Running Directory Applications

9.1	Using the DUA Configuration Utility .....	9-2
9.2	System-wide DUA Defaults .....	9-3
9.3	DUA Defaults for Specific Users .....	9-7
9.4	Configuring DXIM to Use Another Vendor's DSA .....	9-8
9.5	DXIM Command Line Initialization Files .....	9-8
9.6	Running DXIM .....	9-9
9.7	Using the Lookup Client Configuration Utility .....	9-9
9.8	Running the Lookup Client .....	9-11

## 10 Creating Directory Entries

10.1	Using a Script File to Populate a Naming Context	10-2
10.2	Creating Entries Interactively	10-4
10.3	Managing Multiple Entries	10-5

## 11 Using the Access Control Template File

### A Default Schema Definitions

A.1	Object Classes	A-1
A.1.1	accessControlSubentry	A-1
A.1.2	alias	A-2
A.1.3	applicationEntity	A-2
A.1.4	applicationEntityAlias	A-3
A.1.5	applicationProcess	A-4
A.1.6	applicationProcessAlias	A-4
A.1.7	country	A-5
A.1.8	countryAlias	A-5
A.1.9	decDSA	A-6
A.1.10	decDSAAlias	A-7
A.1.11	decALL-IN-1UA	A-7
A.1.12	decMailUA	A-7
A.1.13	decMailUser	A-7
A.1.14	decX400Gateway	A-8
A.1.15	device	A-8
A.1.16	deviceAlias	A-8
A.1.17	dSA	A-9
A.1.18	dSAAlias	A-10
A.1.19	groupOfNames	A-10
A.1.20	groupOfNamesAlias	A-11
A.1.21	locality	A-12
A.1.22	localityAlias	A-12
A.1.23	mhs-user	A-13
A.1.24	organization	A-13
A.1.25	organizationAlias	A-14
A.1.26	organizationalPerson	A-15
A.1.27	organizationalPersonAlias	A-16
A.1.28	organizationalRole	A-16
A.1.29	organizationalRoleAlias	A-17
A.1.30	organizationalUnit	A-18
A.1.31	organizationalUnitAlias	A-19
A.1.32	person	A-19
A.1.33	residentialPerson	A-20
A.1.34	residentialPersonAlias	A-21
A.1.35	shadowingAgreement	A-21
A.1.36	subentry	A-22
A.1.37	top	A-23
A.2	Structure Rules Quick Reference	A-23
A.3	Attributes	A-25
A.3.1	administrativeRole	A-26
A.3.2	aliasedObjectName	A-26
A.3.3	businessCategory	A-27
A.3.4	commonName	A-27

A.3.5	consumerKnowledge . . . . .	A-28
A.3.6	countryName . . . . .	A-28
A.3.7	createTimeStamp . . . . .	A-29
A.3.8	decALL-IN-1UName . . . . .	A-29
A.3.9	decALL-IN-1UserName . . . . .	A-29
A.3.10	decAltMRAddress . . . . .	A-29
A.3.11	decAltRFC822Mailbox . . . . .	A-30
A.3.12	decDDSID . . . . .	A-30
A.3.13	decDDSModificationTimestamp . . . . .	A-30
A.3.14	decDDSNetworkID . . . . .	A-30
A.3.15	decDECnetNodeName . . . . .	A-30
A.3.16	decGlobalSearchBase . . . . .	A-30
A.3.17	decLocalSearchBase . . . . .	A-31
A.3.18	decMailDestination . . . . .	A-31
A.3.19	decMailNonDeliver . . . . .	A-31
A.3.20	decMailworksUserName . . . . .	A-31
A.3.21	decMRAddress . . . . .	A-32
A.3.22	decMTSAltForeignAddressAttr . . . . .	A-32
A.3.23	decMTSDDAType . . . . .	A-32
A.3.24	decMTSForeignAddressAttr . . . . .	A-32
A.3.25	dec-mts-admd-name . . . . .	A-33
A.3.26	dec-mts-prmd-name . . . . .	A-33
A.3.27	dec-mts-talk-other-CCITT-domain . . . . .	A-33
A.3.28	decNumericUserId . . . . .	A-33
A.3.29	decOVVMAddress . . . . .	A-33
A.3.30	decPMAAddress . . . . .	A-33
A.3.31	decPreferredMailAddress . . . . .	A-34
A.3.32	decSNADSAddress . . . . .	A-34
A.3.33	decX400DDA . . . . .	A-34
A.3.34	decX400MRGatewayName . . . . .	A-34
A.3.35	decX400SMTPGatewayName . . . . .	A-35
A.3.36	decX400Redirect . . . . .	A-35
A.3.37	description . . . . .	A-35
A.3.38	destinationIndicator . . . . .	A-35
A.3.39	dseType . . . . .	A-36
A.3.40	dxdUid . . . . .	A-36
A.3.41	facsimileTelephoneNumber . . . . .	A-36
A.3.42	generationQualifier . . . . .	A-37
A.3.43	givenName . . . . .	A-37
A.3.44	governingStructureRule . . . . .	A-37
A.3.45	initials . . . . .	A-38
A.3.46	internationalISDNNumber . . . . .	A-38
A.3.47	knowledgeInformation . . . . .	A-38
A.3.48	lastUpdateReceived . . . . .	A-39
A.3.49	localityName . . . . .	A-39
A.3.50	member . . . . .	A-39
A.3.51	mhs-or-addresses . . . . .	A-39
A.3.52	modifyTimeStamp . . . . .	A-40
A.3.53	myAccessPoint . . . . .	A-40
A.3.54	objectClass . . . . .	A-40
A.3.55	organizationName . . . . .	A-41
A.3.56	organizationalUnitName . . . . .	A-41
A.3.57	owner . . . . .	A-42
A.3.58	physicalDeliveryOfficeName . . . . .	A-42



A.3.59	postalAddress . . . . .	A-42
A.3.60	postalCode . . . . .	A-43
A.3.61	postOfficeBox . . . . .	A-43
A.3.62	preferredDeliveryMethod . . . . .	A-44
A.3.63	prescriptiveACI . . . . .	A-44
A.3.64	presentationAddress . . . . .	A-44
A.3.64.1	Further Syntax Details . . . . .	A-45
A.3.64.1.1	Examples . . . . .	A-47
A.3.65	protocolInformation . . . . .	A-47
A.3.66	registeredAddress . . . . .	A-48
A.3.67	rfc822Mailbox . . . . .	A-48
A.3.68	roleOccupant . . . . .	A-48
A.3.69	searchGuide . . . . .	A-49
A.3.70	seeAlso . . . . .	A-49
A.3.71	serialNumber . . . . .	A-49
A.3.72	shadowingBeginTime . . . . .	A-49
A.3.73	shadowingEndTime . . . . .	A-50
A.3.74	shadowingID . . . . .	A-50
A.3.75	shadowingLastUpdate . . . . .	A-50
A.3.76	shadowingNextUpdate . . . . .	A-50
A.3.77	shadowingState . . . . .	A-50
A.3.78	shadowingMaster . . . . .	A-50
A.3.79	shadowingPeer . . . . .	A-50
A.3.80	shadowingKnowledgeType . . . . .	A-50
A.3.81	shadowingUPDFile . . . . .	A-51
A.3.82	shadowingUPDOffset . . . . .	A-51
A.3.83	shadowingVersion . . . . .	A-51
A.3.84	shadowingFlags . . . . .	A-51
A.3.85	specificKnowledge . . . . .	A-51
A.3.86	stateOrProvinceName . . . . .	A-52
A.3.87	streetAddress . . . . .	A-52
A.3.88	subordinateDeletedTimeStamp . . . . .	A-52
A.3.89	subtreeSpecification . . . . .	A-52
A.3.90	superiorKnowledge . . . . .	A-53
A.3.91	supplierKnowledge . . . . .	A-53
A.3.92	supportedApplicationContext . . . . .	A-53
A.3.93	surname . . . . .	A-53
A.3.94	trustedDSAName . . . . .	A-54
A.3.95	telephoneNumber . . . . .	A-54
A.3.96	teletexTerminalIdentifier . . . . .	A-54
A.3.97	telexNumber . . . . .	A-55
A.3.98	title . . . . .	A-55
A.3.99	userPassword . . . . .	A-56
A.3.100	x121Address . . . . .	A-56
A.4	Syntaxes . . . . .	A-56
A.4.1	aciSyntax . . . . .	A-56
A.4.2	bitStringSyntax . . . . .	A-57
A.4.3	booleanSyntax . . . . .	A-57
A.4.4	countryNameSyntax . . . . .	A-57
A.4.5	deltaTimeSyntax . . . . .	A-58
A.4.6	directoryStringSyntax . . . . .	A-58
A.4.7	distinguishedNameSyntax . . . . .	A-58
A.4.8	facsimileTelephoneNumberSyntax . . . . .	A-58
A.4.9	generalizedTimeSyntax . . . . .	A-58

A.4.10	iA5StringSyntax . . . . .	A-59
A.4.11	integerListSyntax . . . . .	A-59
A.4.12	integerSyntax . . . . .	A-59
A.4.13	mhs-or-address-syntax . . . . .	A-59
A.4.14	mhs-or-name-syntax . . . . .	A-60
A.4.15	numericStringSyntax . . . . .	A-60
A.4.16	objectIdentifierSyntax . . . . .	A-60
A.4.17	octetStringSyntax . . . . .	A-60
A.4.18	postalAddressSyntax . . . . .	A-60
A.4.19	presentationAddressSyntax . . . . .	A-61
A.4.20	printableStringSyntax . . . . .	A-61
A.4.21	protocolInformationSyntax . . . . .	A-61
A.4.22	stringListSyntax . . . . .	A-61
A.4.23	stringSyntax . . . . .	A-62
A.4.24	telephoneNumberSyntax . . . . .	A-62
A.4.25	teletexTerminalIdentifierSyntax . . . . .	A-62
A.4.26	telexNumberSyntax . . . . .	A-62
A.4.27	undefinedSyntax . . . . .	A-63
A.4.28	userPasswordSyntax . . . . .	A-63
A.4.29	uTCTimeSyntax . . . . .	A-63
A.5	Matching Rules . . . . .	A-63
A.5.1	Equality Matching Rules . . . . .	A-64
A.5.1.1	aciItemMatch . . . . .	A-64
A.5.1.2	booleanMatch . . . . .	A-65
A.5.1.3	caseExactIA5StringMatch . . . . .	A-65
A.5.1.4	caseExactStringMatch . . . . .	A-65
A.5.1.5	caseIgnoreListMatch . . . . .	A-65
A.5.1.6	caseIgnoreIA5StringMatch . . . . .	A-65
A.5.1.7	caseIgnoreStringMatch . . . . .	A-66
A.5.1.8	dec-mts-or-name-match . . . . .	A-66
A.5.1.9	deltaTimeMatch . . . . .	A-66
A.5.1.10	distinguishedNameMatch . . . . .	A-66
A.5.1.11	exactEncodingMatch . . . . .	A-66
A.5.1.12	generalizedTimeEqualityMatch . . . . .	A-67
A.5.1.13	integerMatch . . . . .	A-67
A.5.1.14	mhs-or-address-match . . . . .	A-67
A.5.1.15	numericStringMatch . . . . .	A-67
A.5.1.16	objectIdentifierMatch . . . . .	A-67
A.5.1.17	octetStringMatch . . . . .	A-67
A.5.1.18	presentationAddressMatch . . . . .	A-68
A.5.1.19	telephoneNumberMatch . . . . .	A-68
A.5.1.20	uTCTimeMatch . . . . .	A-68
A.5.2	Ordering Matching Rules . . . . .	A-68
A.5.2.1	caseExactIA5StringMatch . . . . .	A-68
A.5.2.2	caseExactStringMatch . . . . .	A-68
A.5.2.3	caseIgnoreIA5StringMatch . . . . .	A-68
A.5.2.4	caseIgnoreListMatch . . . . .	A-69
A.5.2.5	caseIgnoreStringMatch . . . . .	A-69
A.5.2.6	distinguishedNameMatch . . . . .	A-69
A.5.2.7	generalizedTimeOrderingMatch . . . . .	A-69
A.5.2.8	integerMatch . . . . .	A-69
A.5.2.9	numericStringMatch . . . . .	A-69
A.5.2.10	objectIdentifierMatch . . . . .	A-69
A.5.2.11	octetStringMatch . . . . .	A-70

A.5.2.12	telephoneNumberMatch . . . . .	A-70
A.5.2.13	uTCTimeMatch . . . . .	A-70
A.5.3	Substring Matching Rules . . . . .	A-70
A.5.3.1	caseExactIA5SubstringMatch . . . . .	A-70
A.5.3.2	caseExactSubstringMatch . . . . .	A-70
A.5.3.3	caseIgnoreListSubstringMatch . . . . .	A-70
A.5.3.4	caseIgnoreIA5SubstringMatch . . . . .	A-71
A.5.3.5	caseIgnoreSubstringMatch . . . . .	A-71
A.5.3.6	numericSubstringMatch . . . . .	A-71
A.5.3.7	telephoneNumberSubstringMatch . . . . .	A-71
A.5.4	Approximate Matching Rules . . . . .	A-72
A.5.4.1	allWordApproximateMatch . . . . .	A-72
A.5.4.2	initialLetterApproximateMatch . . . . .	A-72
A.5.4.3	initialWordApproximateMatch . . . . .	A-73
A.5.4.4	lastWordSoundexMatch . . . . .	A-73

## B The PrescriptiveACI Attribute

B.1	User-First ACIitems . . . . .	B-1
B.2	Item-First ACIitems . . . . .	B-3
B.3	Item Classes . . . . .	B-5
B.4	User Classes . . . . .	B-7
B.5	Permissions . . . . .	B-10
B.6	Access Control Template File . . . . .	B-14

## Glossary

## Index

## Figures

1-1	The Hierarchical or Tree Structure of Directory Information . . . . .	1-2
1-2	A Typical Directory Entry . . . . .	1-3
1-3	Distinguished Names . . . . .	1-5
1-4	The X.500 Model of Enterprise Directories . . . . .	1-8
1-5	A DIT Divided and Distributed Amongst Four DSAs . . . . .	1-10
1-6	A DIT Distributed and Replicated Amongst Four DSAs . . . . .	1-11
3-1	Structure and Distribution of the Example DIT . . . . .	3-2
3-2	Structure and Distribution of the Example DIT . . . . .	3-12
3-3	DSA1 After All Tasks Are Completed . . . . .	3-16
3-4	DSA2 After All Tasks Are Completed . . . . .	3-17
4-1	A DIT Based on Organizational Units . . . . .	4-3
4-2	A DIT Based on Geographical Distribution . . . . .	4-4
4-3	A DIT Based on Geographical and Organizational Elements . . . . .	4-5
4-4	Accommodating Resource Mobility . . . . .	4-7
4-5	Two Ways to Represent Organizational and Geographical Details . . . . .	4-10
4-6	The Most Frequently Used Default Structure Rules . . . . .	4-12
4-7	The Abacus DIT with its Global Prefix . . . . .	4-14
4-8	The Abacus DIT with its Entries Named . . . . .	4-16
4-9	DSA Entries Beneath the Organization Entry . . . . .	4-20

5-1	Dividing a DIT into Naming Contexts . . . . .	5-2
5-2	Distributing Naming Contexts to Their Master DSAs . . . . .	5-6
5-3	Primary and Secondary Shadowing of Naming Contexts . . . . .	5-7
5-4	Replicating Naming Contexts to Their Shadow DSAs . . . . .	5-8
5-5	Worksheet for CN=DSA1 Listing AE Title and Password . . . . .	5-10
5-6	Worksheet for CN=DSA2 Listing Naming Contexts . . . . .	5-12
5-7	Worksheet for CN=DSA2 Listing Consumers . . . . .	5-13
5-8	Worksheet for CN=DSA2 Listing Suppliers . . . . .	5-14
5-9	A Multi-Layered Division of a DIT . . . . .	5-15
5-10	Worksheet for CN=DSA1 Listing Subordinate Naming Contexts . . . . .	5-16
6-1	DXIM Find Window . . . . .	6-29
6-2	DXIM Find Window Showing Filter Fields . . . . .	6-32
7-1	Recommended Position for Creating an Access Control Subentry . . . . .	7-2
7-2	Access Control in a DSA . . . . .	7-9
8-1	Contiguous Naming Contexts . . . . .	8-2
8-2	Worksheet for CN=DSA1 . . . . .	8-12
8-3	Planned Replication of Naming Contexts . . . . .	8-14
A-1	Structure Rules for Classes: Part I . . . . .	A-24
A-2	Structure Rules for Classes: Part II . . . . .	A-25

**Tables**

4-1	Naming Attributes of Commonly Used Classes . . . . .	4-15
-----	------------------------------------------------------	------

---

# Preface

## Purpose of this Guide

This guide introduces the Compaq™ Enterprise Directory for eBusiness product. It explains how to plan an Enterprise Directory for your organization, and how to configure and maintain it.

## Related Documentation

Enterprise Directory managers also need *Compaq Enterprise Directory for eBusiness Problem Solving*.

The DXIM utility help and the Directory module help of the NCL director both provide useful information about managing directory information and services.

## Abbreviations and Acronyms

ACIitem	Access Control Information Item
ASN.1	Abstract Syntax Notation 1
CCITT	International Telegraph and Telephone Consultative Committee
DIB	Directory Information Base
DIT	Directory Information Tree
DSA	Directory System Agent
DUA	Directory User Agent
DXIM	Compaq X.500 Information Management utility
EMA	Enterprise Management Architecture
ISO	International Organization for Standardization
ITU-T	International Telephone Union - Telecommunications
LDAP	Lightweight Directory Access Protocol
MTA	Message Transfer Agent
NCL	Network Control Language
RDN	Relative Distinguished Name

## Conventions Used in this Guide

<code>monospace text</code>	Screen displays, command lines, and X.500 schema definitions. For example, <code>commonName</code> .
<b><i>bold italics</i></b>	New terminology. For example, <b><i>distinguished name</i></b> .
[ ]	Indicates an optional clause in a schema definition. Encloses record datatypes in NCL commands.
<>	In DXIM syntax examples, to indicate a variable to be supplied by the user. For example: <code>show &lt;name&gt; attributes &lt;attr&gt;</code>
...	In DXIM syntax examples, to indicate that an argument can be repeated. For example: <code>attributes &lt;attr&gt; [, ...]</code>

OpenVMS
---------

Indicates the start of information that is applicable only to the OpenVMS operating system.

Tru64  
UNIX

Indicates the start of information that is applicable only to the Tru64 UNIX operating system.



Indicates the end of information specific to an operating system.

# Part I

---

## Introduction

This part provides an overview of Compaq's Enterprise Directory for eBusiness product, and a tutorial, to enable you to experiment with the product before trying to implement an Enterprise Directory.

- Chapter 1 introduces important concepts and features of the product.

This chapter is not essential, but you are strongly recommended to read it before trying to implement a Enterprise Directory.

- Chapter 2 provides a tutorial in which you are told how to set up a single node Enterprise Directory.

This chapter is not essential, but it does provide a step-by-step example to get you started. It enables you to set up a very simple service.

- Chapter 3 provides a tutorial in which you are told how to set up a two node Enterprise Directory complete with replication, access controls, and directory applications.

This chapter is not essential, but it does provide a step-by-step example of the tasks involved in setting up an Enterprise Directory. It enables you to gain expertise before committing yourself to a real implementation.





---

# Directory Information and Enterprise Directories

Compaq's Enterprise Directory for eBusiness product is an implementation of the ISO and ITU-T<sup>1</sup> series of standards and recommendations for Enterprise Directories. ISO and ITU-T define models and protocols for Enterprise Directories that enable software vendors to build products that can work together to provide a single, scalable, networked Enterprise Directory.

The Enterprise Directory for eBusiness product is an Lightweight Directory Access Protocol (LDAP) enabled directory, and implements the LDAP V2 and V3 protocols.

The purpose of such an Enterprise Directory is to store and provide access to information about objects such as people, computers, printers, and applications. Such information could be used, for example, by a messaging application to store information that enables it to route messages across a network.

This chapter explains the X.500 concepts that will help you plan and configure Compaq's Enterprise Directory for eBusiness product for your organization.

This chapter divides the X.500 concepts into two categories:

- Directory information  
You need to understand the way information is represented in an X.500 Enterprise Directory, so that you can plan how best to use the Enterprise Directory to meet your organization's information requirements.
- Enterprise Directories  
You need to understand the services that the Enterprise Directory product provides to its users, and how the software components of the product cooperate to provide answers to requests for information. This will help you to plan how to configure your Enterprise Directory.

## 1.1 Directory Information

The Enterprise Directory stores information as *directory entries*, each entry representing an object, such as a person, a place, an organization, or a computer.

The entries are organized into a *Directory Information Tree (DIT)*, such that some entries are subordinate to others. Figure 1-1 illustrates the DIT structure, showing a number of directory entries forming a hierarchy beneath a root. Note that, by convention, the root of the DIT is at the top of the picture.

---

<sup>1</sup> The ITU-T was formerly known as the CCITT and some of their publications still have CCITT identification material.

# Directory Information and Enterprise Directories

## 1.1 Directory Information

Figure 1–1 The Hierarchical or Tree Structure of Directory Information

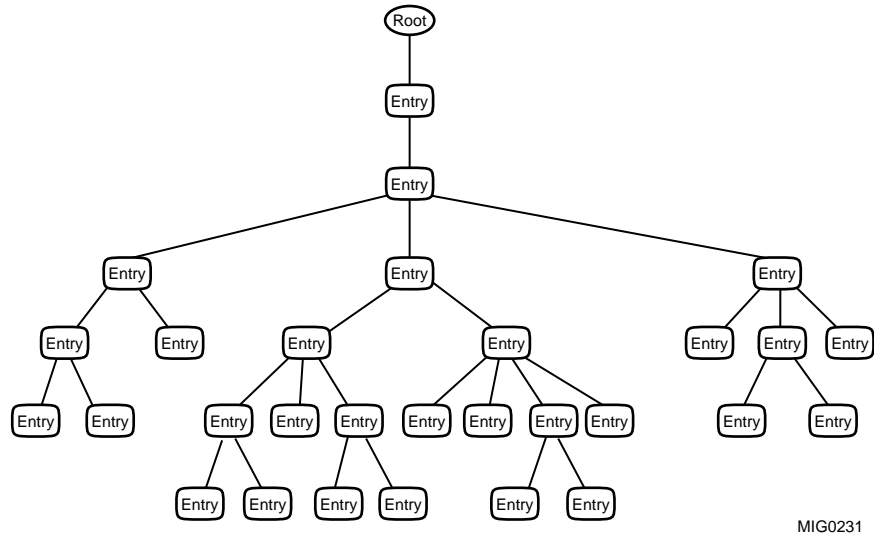

The position of entries in the hierarchy should be based on the relationships between the objects they represent in the real world. For example, an entry representing a person might be positioned beneath an entry representing the organization the person works for. The hierarchical structure is the basis of each entry's name, as described in Section 1.1.2. The structure also enables the DIT to be divided into subtrees which can be distributed and replicated amongst multiple servers, as described in Section 1.2.2. This means that the DIT is scalable to any size.

### 1.1.1 Entries

Within the Enterprise Directory, objects are represented as directory entries. There should be one directory entry for each object that you want to represent. Each entry is made up of a set of attributes, each of which has one or more values. Figure 1–2 illustrates how an application might display a typical entry representing a person.

Figure 1–2 A Typical Directory Entry

Common Name	Joan Smith	JP Smith	Joan Paulette Smith
Surname	Smith		
Telephone Number	+43 734 579887	+43 734 579864	
Postal Address	141 Trent Road, Lower Dingle, Dorset		
Postal Code	HA4 8UU		
Description	Project Supervisor		
Object Class	Organizational Person		

MIG0232

### 1.1.1.1 Attributes

An **attribute** is information of a particular type about an entry. Every attribute has an **attribute type** and at least one **attribute value**. For example, the entry in Figure 1–2 includes an attribute of the type `commonName`<sup>1</sup> with three values, each of which is a variation of the name of the person that the entry represents.

The definition of each attribute type specifies whether the attribute can have more than one value, and whether there are any constraints on the length or the range of the value. Section 1.2.1 explains how these definitions are enforced and managed. Note that the values of a multi-valued attribute are not ordered.

Every attribute type is associated with an **attribute syntax** which defines the format of its value. For example, the `telephoneNumber` attribute type uses the `telephoneNumberSyntax`.

Each attribute type is also associated with one or more **matching rules**. A matching rule specifies how the Enterprise Directory will compare attribute values with each other for certain user requests. For example, some matching rules are insensitive to the case of characters, such that a user searching for `commonName="JOAN SMITH"` would find an entry with the value `commonName="Joan Smith"`.

Each attribute type may be associated with matching rules that support exact matching, substring matching, approximate (phonetic) matching, and ordering of values. Later chapters of this guide explain how to define your own attributes as extensions to the product.

### 1.1.2 Entry Names

As Figure 1–2 illustrates, a typical entry can have several attribute values that represent names by which the object is known, such as surnames and common names. However, so that the Directory Service can unambiguously identify an individual entry, each entry also has a **directory name**.

A directory name identifies an individual entry in terms of that entry's position in the hierarchy of the DIT (illustrated in Figure 1–1).

<sup>1</sup> Throughout this guide, attribute types and other X.500 definitions are referred to using monospace typeface.

## Directory Information and Enterprise Directories

### 1.1 Directory Information

There are two types of directory name:

- Distinguished names
- Alias names

Every directory entry has only one distinguished name, but can also have several alias names. Section 1.1.2.1 and Section 1.1.2.2 describe distinguished names and alias names in detail.

#### 1.1.2.1 Distinguished Names

Every entry has one distinguished name. A distinguished name is made up of a sequence of terms, each of which is called a ***relative distinguished name (RDN)***. Each RDN in an entry's distinguished name represents one of the entries that forms the path from the root of the DIT to the entry.

Each RDN is an attribute type and value chosen from the attributes of the entry that it names. If the attribute type you use for naming has more than one value, then you must choose which value is to serve as the RDN. For example, for the typical entry illustrated in Figure 1–2, if the `commonName` attribute type is used for naming, then you need to choose one of the three values of `commonName`. Any other values are still present in the entry, but do not form part of the entry's distinguished name.

It is possible for an RDN to contain more than one attribute type and value from an entry. For example, a typical RDN would be `commonName="Joan Smith"`, but it is also possible to have an RDN such as `commonName="Joan Smith",locality="Lower Dingle"`. Typically, using more than one attribute in an RDN makes directory names less user friendly.

---

#### Note

---

Most directory applications use abbreviations for attribute types. For example, `commonName` is often abbreviated to `CN`. Thus, `commonName="Joan Smith"` is abbreviated to `CN="Joan Smith"`.

Most examples in this guide use the default abbreviations to shorten entry names. You can customize Compaq's directory applications to suit local conventions or language.

---

No two entries that have the same immediately superior entry can have the same attribute type and value or combination of attribute types and values chosen to be the RDN. Thus, each RDN is unique amongst the subordinates of a given entry.

One of your planning tasks will be to decide how to resolve name clashes, for example, if you have two Joan Smiths in the same part of your organization. Chapter 4 explains name planning.

Figure 1–3 shows how RDNs are used to form unambiguous distinguished names.

The entry representing Joan Smith (at the bottom left of the illustration) has a distinguished name made up of four RDNs. The first three RDNs represent the three entries that form a path from the root of the DIT to Joan's entry. The fourth RDN is that of Joan's entry itself. Since each RDN is unique relative to its superior entry, the distinguished name is also guaranteed to be unique.

**Figure 1–3 Distinguished Names**

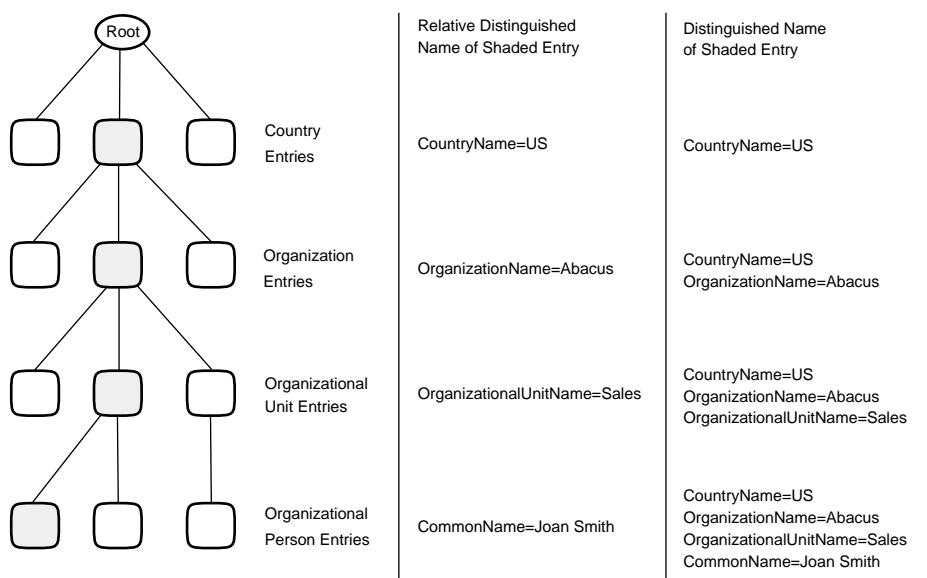

MIG0233

A typical directory application would display Joan's distinguished name (using abbreviations) as follows:

```
/C=US/O=Abacus/OU=Sales/CN="Joan Smith"
```

The abbreviation **C** means **countryName**, **O** means **organizationName**, **OU** means **organizationalUnitName**, and **CN** means **commonName**. The four RDNs in the distinguished name are separated by the / character, and are listed in order of hierarchical superiority, with the RDN of the entry closest to the root of the DIT listed first.

The exact conventions used to display a distinguished name vary between applications. The conventions shown are the ones used by the Compaq X.500 Information Management (DXIM) utility. The LDAP convention is :

```
CN="Joan Smith", OU=Sales, O=Abacus, C=US
```

### 1.1.2.2 Alias Names

Although an entry has only one distinguished name, there can be many **alias names** for an entry. This means that an entry can be referred to using either its distinguished name, or any one of its alias names.

An alias name looks just like a distinguished name. However, an alias name does not represent the direct path from the root of the DIT to the entry. Instead, as the Enterprise Directory follows the path from the root, it finds that the path leads to an **alias entry**. The alias entry has an attribute that contains the directory name of the entry to which the alias refers.

For example, if Joan Smith (see Figure 1–3) has recently married, and might still be known by her unmarried name Joan Meredith, then you could create an alias entry called `/C=US/O=Abacus/OU=Sales/CN="Joan Meredith"`. Any user request that specifies this alias name is automatically redirected.

## Directory Information and Enterprise Directories

### 1.1 Directory Information

#### 1.1.3 Classes

Every entry is classified according to the characteristics of the object that it represents. When you create an entry, you have to specify what **class** of entry it is. To do this, you use the `objectClass` attribute.

Compaq's Enterprise Directory for eBusiness provides several different classes, such as `organizationalPerson` and `residentialPerson`. See Appendix A for details of the classes provided by the Compaq Enterprise Directory for eBusiness. Later chapters of this guide also explain how to define classes of your own.

Each class definition specifies **mandatory attributes** and **optional attributes** for entries of that class. Most classes also have **name forms** and **structure rules** defined for them. The following sections explain each of these in more detail.

##### 1.1.3.1 Mandatory Attributes

Most classes of entry have mandatory attributes. When you create an entry, you must supply values for each of the mandatory attributes, or the creation will fail. Also, any attempt to modify a mandatory attribute so as to remove all of its values will fail unless a replacement value is specified.

For example, for the `organizationalPerson` class, the mandatory attributes are `objectClass`, `commonName`, and `surname`. So, when you create an entry of this class, you must supply values for these three attributes.

Appendix A details the mandatory attributes of all classes provided with the Compaq Enterprise Directory for eBusiness product.

##### 1.1.3.2 Optional Attributes

Most classes of entry have optional attributes. You can add and remove optional attributes at any time. However, even though an attribute may be optional, some directory users might be depending on its presence. Therefore, you should be careful not to remove or modify attributes without making sure that you are not inconveniencing other directory users.

Appendix A details the optional attributes of all classes provided with the Compaq Enterprise Directory for eBusiness product.

##### 1.1.3.3 Name Forms

Classes have name forms. A name form states that the attribute value that is used in the RDN of an entry must be chosen from a particular attribute or set of attributes.

For example, when you choose the RDN of an `organization` entry, you must use `organizationName` attribute. If you try to use any other attribute in the RDN of an `organization` entry, the Enterprise Directory returns an error and does not create the entry.

These name forms encourage managers of different parts of the DIT to use consistent styles of naming for their entries. Consistent naming improves the usability of the directory, especially for non-technical users. Appendix A details the name forms of all classes provided with the Compaq Enterprise Directory for eBusiness product.

## Directory Information and Enterprise Directories

### 1.1 Directory Information

#### 1.1.3.4 Structure Rules

Structure rules state that entries of a given class must be subordinate to an entry of another specified class (or one of a set of classes).

For example, the structure for the `organizationalUnit` class states that the immediate superior of an `organizationalUnit` entry must be an `organization` entry or a `locality` entry, or another `organizationalUnit` entry. If you try to create an `organizationalUnit` entry as a subordinate of any other class of entry, the Enterprise Directory returns an error and does not create the entry.

These structure rules encourage managers of different parts of the DIT to design similar naming trees for their entries. Consistent tree structures improve the usability of the directory, especially for non-technical users. Appendix A details the structure rules of all classes provided with the Compaq Enterprise Directory for eBusiness product.

## Directory Information and Enterprise Directories

### 1.2 Enterprise Directories

### 1.2 Enterprise Directories

Section 1.1 described the information that is stored in the directory. This section explains the services that the Compaq Enterprise Directory for eBusiness product provides to its users.

The Enterprise Directory is provided by two types of software component:

- Directory System Agents (DSAs)
- Directory User Agents (DUAs)

A DSA is a server. It is responsible for storing directory entries, and for providing access to them. A DSA is also responsible for redirecting requests for information that it does not store. You can install one DSA per node (or one DSA per VMS cluster).

A DUA forms part of a client application. A DUA enables users to formulate requests for directory information, such as a request to create or view an entry. A DUA uses a standard protocol to pass requests to a DSA, and to receive answers back from the DSA. There might be many different client applications installed on a single system.

**Figure 1–4 The X.500 Model of Enterprise Directories**

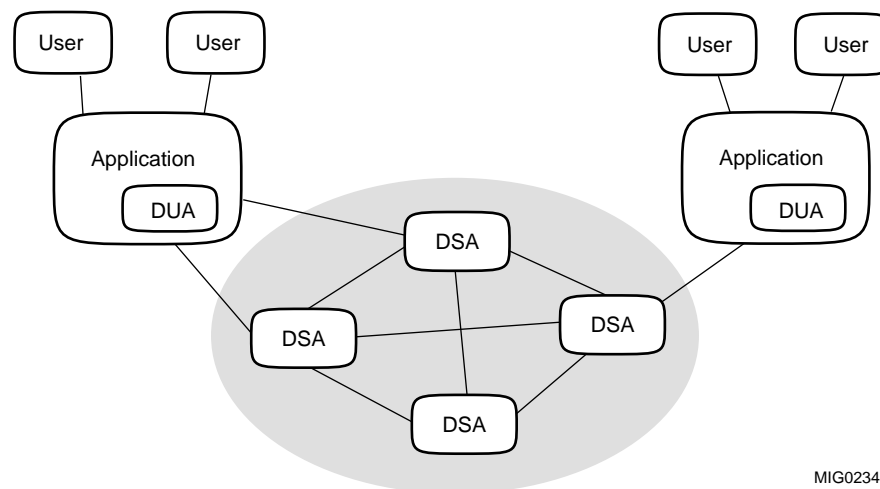

MIG0234

Figure 1–4 illustrates the X.500 model of directory components, showing how a number of DSAs serve a number of directory applications. Each directory application includes a DUA. The directory applications serve a number of users, which can be human users or other applications.

The Compaq Enterprise Directory for eBusiness product provides a DSA and the Compaq X.500 Information Management utility (DXIM). DXIM is an example of an application that includes a DUA. DXIM uses the standard protocol to communicate with DSAs.

Because Compaq's DSAs and directory applications use standard protocols, they can interwork with other vendors' X.500 conformant DSAs and directory applications. For example, you can use DXIM to manage entries in another vendor's DSA, or use another vendor's application to manage entries in a Compaq DSA.



## Directory Information and Enterprise Directories

### 1.2 Enterprise Directories

The DSA and directory applications cooperate to provide two main types of access to directory information:

- Interrogations of the directory information
- Modifications of the directory information

The interrogation services provide different ways of looking at the information in the directory, such as inspecting particular attributes of an entry, or searching for entries that have a specified set of attributes. The modification services allow you to create new entries, remove entries, and modify the attributes of entries.

To provide an efficient and consistent service to users, DSAs can provide a set of services that are not necessarily visible to the user. These are:

- Schema enforcement
- Distribution of directory information
- Replication of directory information
- Distribution of user requests to multiple DSAs
- Control of access to directory information
- Accounting for the use of the Enterprise Directory

These services are described in the following sections.

#### 1.2.1 The Schema

Whenever you create or modify a directory entry, the Enterprise Directory ensures that the entry and its attributes conform to their definitions.

For example, when you create an entry, the Enterprise Directory ensures that you have supplied all of the mandatory attributes, that all the attribute values are of the correct syntaxes, and that the entry conforms to the structure rules and name forms defined for its class.

If an entry you are creating or modifying does not satisfy the rules, then the Enterprise Directory returns an error and does not create or modify the entry.

The Enterprise Directory can provide this service because each DSA has a set of rules, called the *schema*. Each DSA has a copy of the schema that applies to all entries that it holds. It is possible for different DSAs to apply different sets of rules.

The Compaq Enterprise Directory for eBusiness product provides a schema that you can use as it is, or edit to suit your particular needs. For ease of management, Compaq recommends that all DSAs use the same schema.

Some Compaq applications also use the schema. For example, DXIM uses the abbreviations and window definitions that are defined in the schema.

#### 1.2.2 Distributing Directory Information

The amount of directory information a DSA can hold depends on the resources available on the DSA's node. You can install one DSA per node or VMS cluster. A single DSA can hold tens or even hundreds of thousands of entries, depending on its resources.

To enable the DIT to exceed the capacity of a single DSA, the Compaq Enterprise Directory for eBusiness product enables you to distribute directory information so that each DSA only holds part of the DIT.

## Directory Information and Enterprise Directories

### 1.2 Enterprise Directories

You can divide your organization's DIT into subtrees, each of which is called a **naming context**, and each DSA holds one or more naming contexts. Thus, although you can only have one DSA per node, that DSA can hold more than one naming context.

Figure 1-5 shows a DIT that is divided into four naming contexts, which are distributed amongst four DSAs. In this example, each DSA holds only one naming context.

Figure 1-5 A DIT Divided and Distributed Amongst Four DSAs

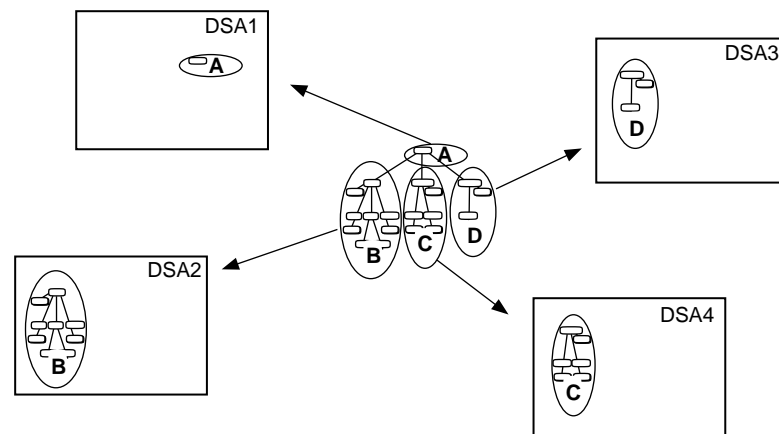

MIG0502

Part II explains how to plan the distribution of directory information so that each DSA holds the naming contexts that are most useful to the DSA's local users.

The ability to distribute directory information means that there is no limit to the total amount of information that can be stored. You can always add new DSAs to increase capacity.

However, the distribution of the DIT does not mean that a user needs to know which DSA to ask for a particular piece of information. Instead, each DSA keeps **knowledge information** that helps it redirect requests (see Section 1.2.4).

Using this knowledge information, DSAs cooperate so that the user receives a response regardless of which DSA they originally contact. Compaq's DSAs can have knowledge information about other vendors' DSAs, as well as about other Compaq DSAs.

#### 1.2.3 Replicating Directory Information

The Compaq Enterprise Directory for eBusiness product not only enables you to distribute directory information (see Section 1.2.2), but it also enables you to copy information amongst your Compaq DSAs. This is known as **replicating** or **shadowing** information<sup>1</sup>.

<sup>1</sup> The term **shadowing** in X.500 means simply "copying information", and must not be confused with concepts such as "disk shadowing".

## Directory Information and Enterprise Directories

### 1.2 Enterprise Directories

This means that you can have copies of information in several locations, improving response times, and increasing the availability of information. Figure 1-6 shows a DIT that is divided into four naming contexts that are distributed and replicated amongst four DSAs. The arrows show the source and destination of each replicated naming context.

Figure 1-6 A DIT Distributed and Replicated Amongst Four DSAs

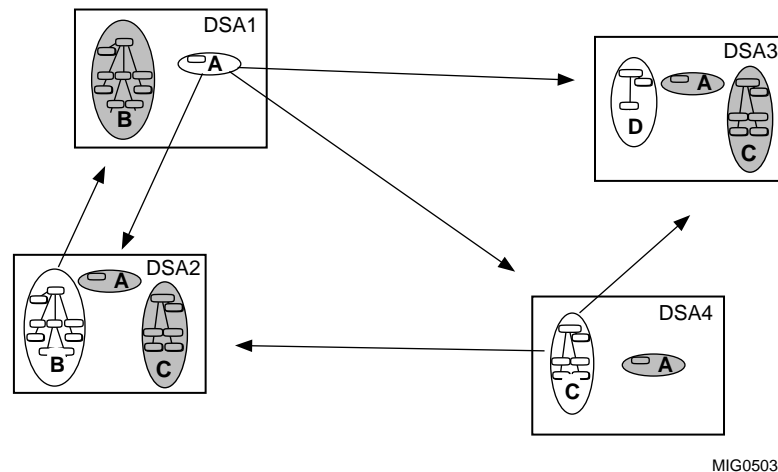

The ability to replicate information makes the Enterprise Directory suitable for organizations that want users and applications in many locations to have efficient access to a large amount of directory information.

Compaq DSAs use standard protocols to ensure that copies of entries are kept up to date without manual intervention.

#### 1.2.4 Distributing Requests for Information

The distribution and replication of information across many DSAs means that each DSA needs to know what to do with a request for information that it does not hold. For this reason, every DSA has some knowledge information which tells the DSA how to locate entries held by other DSAs.

Some knowledge information has to be set up manually, and the planning considerations for those setup tasks are discussed in Part II. Some knowledge information is set up automatically during replication.

When a DSA cannot satisfy a request itself, it can automatically pass the request on to one or more other DSAs which, according to its knowledge information, are likely to hold the requested information. This process is called **chaining**.

If a DSA finds that it cannot chain a request, for example, because of network problems or security problems, then it can send information called **referrals** or **continuation references** back to the directory application that made the request. These references contain the network address of the DSA that could not be contacted. This enables an application or user to decide whether to attempt a direct connection to that DSA.

## Directory Information and Enterprise Directories

### 1.2 Enterprise Directories

#### 1.2.5 Controlling Access to Directory Entries

Compaq's Enterprise Directory for eBusiness product provides access controls which enable you to prevent different groups of users from inspecting or modifying some of your directory entries, and to require users to specify a password before gaining certain types of access.

The product allows you to control access to entries, and to particular attributes.

For ease of management, Compaq's Enterprise Directory for eBusiness product provides a template file that you can use to set up access controls for your directory information. The template file is documented so that you know what controls it imposes. Your task is simply to edit the template file to fill in the names of your directory information managers.

If the controls defined by the template file are not suitable, you can customize the template file, or create one of your own. Chapter 7 provides a full description of access control, and the defaults supplied by the template file. Chapter 11 describes how to use the template file.

#### 1.2.6 Accounting for Enterprise Directory Use

Compaq DSAs can be configured to provide accounting records. Each accounting record provides details of one user request. When accounting is enabled, records for all user requests are written to an accounting log file.

Accounting reduces the performance of a DSA, and the accounting log file can grow very rapidly, consuming disk space. Therefore, Compaq recommends that you only enable accounting if you have a requirement to charge for the use of the Enterprise Directory.

If you enable accounting, you will need to build an application that can process the accounting records. Details of the accounting records, and how to enable accounting are provided in *Compaq Enterprise Directory for eBusiness Problem Solving*.

### 1.3 Managing the Compaq Enterprise Directory for eBusiness Product

There are two types of management task for an X.500 Enterprise Directory, and Compaq's Enterprise Directory for eBusiness product divides the management functions accordingly. The management tasks reflect the division between the two sets of concepts:

- Directory information
- Directory services

#### 1.3.1 Managing Directory Information

For the management of information in the DIT, such as entry creation, modification, removal, and display, Compaq's Enterprise Directory for eBusiness product provides DXIM (the Compaq X.500 Information Management utility). DXIM has two interfaces; a command line interface and a windows interface.

If you prefer, you can use an X.500 conformant directory application or an LDAP application from another vendor.

## Directory Information and Enterprise Directories

### 1.3 Managing the Compaq Enterprise Directory for eBusiness Product

#### 1.3.2 Managing the Enterprise Directory

The software components of Compaq's Enterprise Directory for eBusiness product conform to Compaq's Enterprise Management Architecture (EMA).

EMA is based on the director/entity model in which a management system, called a director, controls one or more objects, called entities. Compaq's NCL is an example of a director that you can use to manage the entities in your network.

In the case of Compaq's Enterprise Directory for eBusiness product, there is a management entity representing the DSA, with subentities representing the knowledge information of the DSA.

By managing the DSA entity and its subentities, you can control the behaviour of the DSA, and configure it to carry out its role as part of your Directory Service as a whole.

You should now have an understanding of the important features of directory information and the enterprise directories. Chapter 3 provides a simple tutorial that enables you to experiment with the product. Part II provides detailed advice on designing your directory information.



---

## Single Node X.500 Implementation Tutorial

This chapter provides a simple tutorial of how to set up a single DSA. The tutorial requires one node running one of the supported operating systems: Tru64 UNIX or OpenVMS Alpha.

There are no variables in this tutorial apart from the operating system you use. Type all commands relevant to your operating system exactly as shown.

Note that setting up a single DSA is much easier than setting up a multi-node Enterprise Directory. This tutorial does not demonstrate how to distribute or replicate information across multiple DSAs, and it does not demonstrate how to set up access controls, or how to set up DSAs to interwork securely.

When you have experimented with this simple tutorial, see Chapter 3 for a more complex tutorial that sets up a multi-node Enterprise Directory.

Destroy the single node Enterprise Directory before attempting the multi-node tutorial. The two tutorials are not designed to be compatible.

# Single Node X.500 Implementation Tutorial

## 2.1 Install the Product

### 2.1 Install the Product

Install the product, and do the post installation task(s), as documented on the installation card relevant to your system's operating system.

### 2.2 Configure the DSA

Configure the DSA as follows:

1. Run the DSA configuration utility.

Tru64  
UNIX

You need superuser privileges to run the configuration utility. To run the utility, type:

```
# /var/dxd/scripts/dsa_configure
```

◆

OpenVMS

You need SYSPRV and OPER privileges to run the configuration utility. To run the utility, type:

```
$ @SYS$STARTUP:DXD$DSA_CONFIGURE
```

◆

2. From a privileged account, type:

Tru64  
UNIX

```
# ncl
```

◆

OpenVMS

```
$ RUN SYS$SYSTEM:NCL
```

◆

3. Type the following NCL commands exactly as shown:

```
ncl> CREATE DSA
ncl> CREATE DSA NAMING CONTEXT "/C=US/O=Abacus"
ncl> ENABLE DSA
ncl> EXIT
```



## 2.3 Configure Application Defaults

From a privileged account, type:

```
Tru64
UNIX # /var/dxd/scripts/dua_configure
◆
```

```
OpenVMS $ @SYS$STARTUP:DXD$DUA_CONFIGURE.COM
◆
```

Accept all defaults.

## 2.4 Create Some Directory Entries

1. Invoke the Compaq X.500 information management utility (DXIM), as follows:

```
Tru64
UNIX $ dxim -c
◆
```

```
OpenVMS $ DXIM /INTERFACE=CHARACTER_CELL
◆
```

2. Type the following DXIM commands exactly as shown:

```
dxim> create /C=US/O=Abacus attributes objectclass=organization
dxim> create /C=US/O=Abacus/OU=Sales attributes objectclass=organizationalunit
dxim> create /C=US/O=Abacus/OU=Sales/CN="Francis Black" attributes -
_dxim> objectclass=(organizationalperson,person), surname=black
```

## 2.5 Experiment with the Example Enterprise Directory

You now have a single node Enterprise Directory in which one DSA holds three directory entries. The entries represent Abacus, Sales, and Francis Black respectively. You can now experiment with these entries. For example:

```
dxim> search where surname=black all attributes
dxim> search where surname=b* all attributes
dxim> set /C=US/O=Abacus/OU=Sales/CN="Francis Black" attribute telephone=123456
dxim> search where surname=black attributes telephone, commonName
```

Refer to the DXIM online help for details of all commands. The help contains descriptions and examples of all DXIM commands.

## Single Node X.500 Implementation Tutorial

### 2.6 Destroy the Example Enterprise Directory

## 2.6 Destroy the Example Enterprise Directory

When you have finished experimenting with the example Enterprise Directory, you must delete it from your system.

To delete the example Enterprise Directory configuration, log in to a privileged account, and use the NCL director to disable and delete the DSA on each node, as follows:

```
NCL> DISABLE DSA
```

```
NCL> DELETE DSA
```

Then delete the database files and the defaults files on both systems, as follows:

```
Tru64  
UNIX  
# rm /var/dxd/DSA-information-tree*  
# rm /etc/dua.defaults  
◆
```

```
OpenVMS  
$ DELETE DXD$DIRECTORY:DSA-INFORMATION-TREE.*;*  
$ DELETE DXD$DIRECTORY:DXD$DUA_DEFAULTS.DAT;*  
◆
```

Deleting the database files means that the DSA is returned to its unconfigured state, as it was when you first installed the software. The DSA stores its configuration information and its entries in these files.

---

## Multi-Node X.500 Implementation Tutorial

This chapter provides a simple tutorial for setting up a multi-node Enterprise Directory. The tutorial demonstrates all of the key features of the product; the distribution and replication of information, the use of access controls, and setting up DSAs to interwork securely.

See Chapter 2 for a single-node tutorial. If you have already tried the single node tutorial, make sure you delete it before trying this tutorial.

This tutorial creates a simple directory information tree containing eight directory entries. The tree represents a fictional organization called Abacus.

For the purposes of this tutorial, you are advised to use these fictional names rather than use real names. This enables you to type the commands exactly as documented, reducing the possibility of confusion.

The aim of this tutorial is for you to experiment with the product, and gain familiarity with some of the functionality, concepts, and tasks involved. You can then approach your Enterprise Directory planning tasks with confidence.

This tutorial might contain terms that are not yet familiar to you. However, understanding all of the terms is not a requirement for being able to complete all of the tasks described.

Completing this example does not mean that you do not need to read other parts of this book. You will not succeed in implementing an efficient and appropriate Enterprise Directory for your organization if you do not plan in some detail. This tutorial does not aim to provide an ideal Enterprise Directory, only a working example.

## Multi-Node X.500 Implementation Tutorial

### 3.1 The Characteristics of the Example Enterprise Directory

#### 3.1 The Characteristics of the Example Enterprise Directory

The tasks described in this chapter provide an Enterprise Directory with two DSAs on two nodes. The two DSAs hold different parts of the same directory information tree. Figure 3-1 illustrates the example tree, and its distribution across the two DSAs.

Figure 3-1 Structure and Distribution of the Example DIT

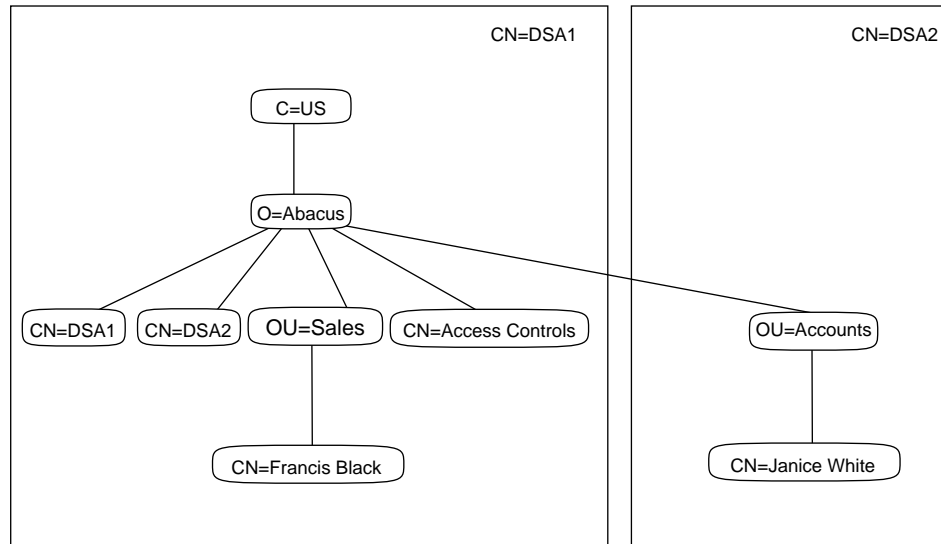

MIG0543

The two DSAs are installed on nodes referred to as NODE\_1 and NODE\_2. You need to decide which of your two nodes is to play the role of NODE\_1, and which is to be NODE\_2, and then apply the tutorial commands as appropriate.

The two DSAs are referred to as CN=DSA1 and CN=DSA2 respectively. Use these exact names for your DSAs. The abbreviation CN means **commonName**, which is the attribute type used for naming DSAs in the directory.

The tutorial includes two entries representing people: Francis Black and Janice White. Francis' entry is held on CN=DSA1 within a Sales organizational unit, and Janice's entry is held on CN=DSA2 within an Accounts organizational unit.

Access control for the example tree is provided by the CN="Access Controls" entry shown in Figure 3-1. The access control entry states that Francis Black is a directory information manager, and that Janice White is an ordinary directory user. The tutorial will show how access rights for these two users differ because of the access controls.

#### 3.2 Install the Product

Install the product on the two systems, as described in the installation documentation for the appropriate operating systems. Complete all post installation tasks.

The two systems need be able to connect to each other using DECnet-Plus networking or TCP/IP RFC1006 networking.

## **Multi-Node X.500 Implementation Tutorial**

### **3.2 Install the Product**

This version of the Enterprise Directory provides a new user application; the Compaq X.500 Lookup Client. The Lookup Client, an optional feature of this tutorial, makes it possible to complete the tasks in Section 3.12.

## Multi-Node X.500 Implementation Tutorial

### 3.3 Run the DSA Configuration Utility on Both Systems

### 3.3 Run the DSA Configuration Utility on Both Systems

This section uses the DSA configuration utility to give each DSA a basic configuration.

1. Run the DSA configuration utility on NODE\_1.

Tru64  
UNIX

You need superuser privileges to run the configuration utility. To run the utility, type:

```
# /var/dxd/scripts/dsa_configure
```

◆

OpenVMS

You need SYSPRV and OPER privileges to run the configuration utility. To run the utility, type:

```
$ @SYS$STARTUP:DXD$DSA_CONFIGURE
```

◆

2. Make a note of the presentation address set by the utility. The utility displays the presentation address before exiting. Presentation addresses are case sensitive, so make an exact note. Cutting and pasting the address to a file might be the most convenient solution.
3. Repeat steps 1 and 2 for NODE\_2.

### 3.4 Complete the Configuration for CN=DSA1

This section completes the configuration for CN=DSA1 on your NODE\_1.

Type all commands exactly as shown, with the exception of the <address> variable.

1. From a privileged account on your NODE\_1, invoke the NCL director:

```
Tru64
UNIX    $ ncl
        ◆
```

```
OpenVMS $ RUN SYS$SYSTEM:NCL
        ◆
```

2. Type the following NCL commands:

```
NCL> CREATE DSA
NCL> SET DSA AE TITLE = "/C=US/O=Abacus/CN=DSA1"
NCL> SET DSA PASSWORD = "MYSTERY"
```

Use upper case for the password, as shown. The password attribute is case sensitive.

3. Type the following NCL command to create a Naming Context entity:

```
NCL> CREATE DSA NAMING CONTEXT "/C=US/O=Abacus"
```

4. Type the following NCL command to create a Subordinate Reference entity:

```
NCL> CREATE DSA SUBORDINATE REFERENCE "/C=US/O=Abacus/OU=Accounts" -
_NCL> ACCESS POINT = {[ AE TITLE="/C=US/O=Abacus/CN=DSA2", -
_NCL> PRESENTATION ADDRESS='<address>' ]}
```

where <address> is the presentation address of NODE\_2, which you made a note of in Section 3.3. Use exactly the same case as was displayed by the configuration utility.

Note that you must quote the presentation address using '' characters, as shown.

5. You can now enable CN=DSA1, and exit the NCL director:

```
NCL> ENABLE DSA
NCL> EXIT
```

## Multi-Node X.500 Implementation Tutorial

### 3.4 Complete the Configuration for CN=DSA1

#### 3.4.1 Notes About the Configuration of CN=DSA1

The password specified in step 2 is required later in this tutorial when you implement replication between the DSAs. The DSA will use its password when communicating with CN=DSA2.

The Naming Context entity created in step 3 means that CN=DSA1 is configured to hold entries representing the fictional Abacus organization. If a DSA has no Naming Context entities, then you cannot create any entries on it. A DSA can have more than one Naming Context entity, but this tutorial creates only one for each DSA.

The Subordinate Reference entity created in step 4 means that entries for the Accounts division are not part of the Abacus naming context. The Subordinate Reference entity marks the boundary between the two naming contexts in this tutorial. The Access Point attribute of the entity identifies the name and presentation address of CN=DSA2. CN=DSA2 will hold a Naming Context entity that represents the Accounts division.

The Subordinate Reference entity enables CN=DSA1 to redirect requests for information in the Accounts division, and informs CN=DSA1 that it is not responsible for the entries representing the Accounts division of the Abacus organization.

The ENABLE DSA command enables the DSA to listen for requests from directory applications or other DSAs. If you do not enable the DSA, applications and other DSAs will be unable to connect to it.



### 3.5 Complete the Configuration for CN=DSA2

This section completes the configuration of CN=DSA2 on your NODE\_2.

Type all commands exactly as shown, with the exception of the <address> variable.

1. From a privileged account on your NODE\_2, invoke the NCL director:

```
Tru64
UNIX      # ncl
          ◆
```

```
OpenVMS  $ RUN SYS$SYSTEM:NCL
          ◆
```

2. Type the following NCL commands:

```
NCL> CREATE DSA
NCL> SET DSA AE TITLE = "/C=US/O=Abacus/CN=DSA2"
NCL> SET DSA PASSWORD = "MYTHICAL"
```

Use upper case for the password, as shown. The password attribute is case sensitive.

3. Type the following command to create a Naming Context entity:

```
NCL> CREATE DSA NAMING CONTEXT "/C=US/O=Abacus/OU=Accounts"
```

4. Type the following command to create a Superior Reference entity:

```
NCL> CREATE DSA SUPERIOR REFERENCE -
_NCL> ACCESS POINT = {[ AE TITLE="/C=US/O=Abacus/CN=DSA1",
_NCL> PRESENTATION ADDRESS='<address>' ]}
```

where <address> is the presentation address of NODE\_1, which you made a note of in Section 3.3. Use exactly the same case as was displayed by the configuration utility.

Note that you must quote the presentation address using '' characters, as shown.

5. You can now enable CN=DSA2, and exit the NCL director:

```
NCL> ENABLE DSA
NCL> EXIT
```

## Multi-Node X.500 Implementation Tutorial

### 3.5 Complete the Configuration for CN=DSA2

#### 3.5.1 Notes About the Configuration of CN=DSA2

The password specified in step 2 is required later in this tutorial when you implement replication between the DSAs. The DSA will use its password when communicating with CN=DSA1.

The Naming Context entity configured in step 3 means that the DSA is configured to hold entries representing the Accounts division, and any entries representing objects within the Accounts division.

The Superior Reference entity configured in step 4 means that any requests that this DSA cannot satisfy are to be passed to CN=DSA1, which holds hierarchically superior information. For example, a request for the Abacus entry will be passed to CN=DSA1 because CN=DSA2 does not hold that information. CN=DSA2 will pass on any requests that do not refer to information within the Accounts subtree.

Note that CN=DSA2 does not have a Subordinate Reference entity, because in this example there are no naming contexts subordinate to the Accounts naming context. If there were another naming context subordinate to the Accounts naming context, a Subordinate Reference entity would be required, specifying which DSA holds the subordinate naming context.

The ENABLE DSA command enables the DSA to listen for requests from directory applications or other DSAs. If you do not enable the DSA, applications and other DSAs will be unable to connect to it.

### 3.6 Configure Application Defaults on Both Systems

This section configures application defaults on both systems. The defaults provide directory applications with information about how to connect to their local DSA.

1. On each system, log in to a privileged account and type:

```
Tru64
UNIX # /var/dxd/scripts/dua_configure
      ◆
```

```
OpenVMS $ @SYS$STARTUP:DXD$DUA_CONFIGURE.COM
        ◆
```

2. Accept all defaults suggested by the utility.

Run the utility on both systems.

#### 3.6.1 Configure Lookup Client Defaults on Both Systems

If you installed the Lookup Client (see Section 3.2), you need to configure it. It cannot use the defaults configured in Section 3.6 because it connects *via* LDAP to the DSA.

Run the Lookup Client configuration utility, as follows:

```
Tru64
UNIX # /usr/sbin/dxdlu_configure
      ◆
```

```
OpenVMS $ @SYS$STARTUP:DXD$LUC_CONFIGURE.COM
        ◆
```

Specify the name of the system that runs the DSA.

When the utility prompts for a search base, type: **O=Abacus, C=US**

Note the different conventions for expressing directory names, for example, /C=US/O=Abacus is expressed as O=Abacus, C=US.

The utility asks whether you want to specify another search base. Type **n**. The utility exits.

## Multi-Node X.500 Implementation Tutorial

### 3.7 Create Some Entries

### 3.7 Create Some Entries

This section describes how to create the entry representing the Abacus organization and its subordinate entries, as shown in Figure 3-1.

Type all commands exactly as shown with the exception of the <address> variable.

The Compaq X.500 information management (DXIM) utility commands shown are not case sensitive, with the exception of passwords and presentation addresses. In this tutorial, passwords are always specified in upper case, and presentation addresses must be copied exactly from the output of the DSA configuration utility (see Section 3.3).

1. Log in to an account on either system. No privileges are required.
2. Invoke the DXIM utility, as follows:

```
Tru64
UNIX    $ dxim -c
        ◆
```

```
OpenVMS $ DXIM /INTERFACE=CHARACTER_CELL
        ◆
```

3. Create the entry that represents Abacus, as follows:

```
dxim> create /C=US/O=Abacus -
_dxim> attributes objectClass=organization, -
_dxim> description="Blue Chip Corporation", -
_dxim> telephone="+44 0022 77755"
```

4. Create the entry to represent the Sales division:

```
dxim> create /C=US/O=Abacus/OU=Sales -
_dxim> attributes objectClass=organizationalUnit, -
_dxim> telephone="+44 0022 65524", -
_dxim> description="Sales and Services"
```

5. Create the entry to represent Francis Black:

```
dxim> create /C=US/O=Abacus/OU=Sales/CN="Francis Black" -
_dxim> attributes objectClass=(organizationalPerson,person), -
_dxim> surname=Black, telephoneNumber="647 1515", -
_dxim> password=TANGERINE
```

All of the above entries are created on CN=DSA1, because they are part of the naming context called /C=US/O=Abacus. This succeeds even if you are using DXIM on NODE\_2, because CN=DSA2 has a Superior Reference that enables it to pass the requests on to CN=DSA1.

The next two tasks shown in this section create entries on CN=DSA2. Again, the commands will succeed even if you are using DXIM on NODE\_1, because CN=DSA1 has a Subordinate Reference that enables it to pass the requests on to CN=DSA2.

6. Create the entry to represent the Accounts division:

```
dxim> create /C=US/O=Abacus/OU=Accounts -
_dxim> attributes objectClass=organizationalUnit, -
_dxim> telephone="+44 0022 91182", -
_dxim> description="Financial Services"
```

## Multi-Node X.500 Implementation Tutorial

### 3.7 Create Some Entries

#### 7. Create the entry to represent Janice White:

```
dxim> create /C=US/O=Abacus/OU=Accounts/CN="Janice White" -
_dxim> attributes objectClass=(organizationalPerson,person), -
_dxim>      surname=White, telephone="+44 0022 12299", -
_dxim>      password=CLEMENTINE
```

The remaining commands create entries to represent the two DSAs themselves.

#### 8. Create entries to represent CN=DSA1 and CN=DSA2

```
dxim> create /C=US/O=Abacus/CN=DSA1 -
_dxim> attributes objectClass=(decDSA,DSA,applicationEntity), -
_dxim>      trustedDSAName="/C=US/O=Abacus/CN=DSA1", -
_dxim>      password=MYSTERY, -
_dxim>      presentationAddress='<address>'

dxim> create /C=US/O=Abacus/CN=DSA2 -
_dxim> attributes objectClass=(decDSA,DSA,applicationEntity), -
_dxim>      trustedDSAName="/C=US/O=Abacus/CN=DSA2", -
_dxim>      password=MYTHICAL, -
_dxim>      presentationAddress='<address>'
```

where, in each case, the password matches the password specified in Section 3.4 or Section 3.5 as appropriate, and the presentation addresses match the ones you made a note of in Section 3.3 for each DSA.

## Multi-Node X.500 Implementation Tutorial

### 3.8 Summary of the Tasks Completed So Far

### 3.8 Summary of the Tasks Completed So Far

The steps completed so far create a distributed directory shown in Figure 3–2. If you compare this picture to Figure 3–1, you can see that the only entry that has not yet been created is the Access Controls entry (see Section 3.9).

Figure 3–2 Structure and Distribution of the Example DIT

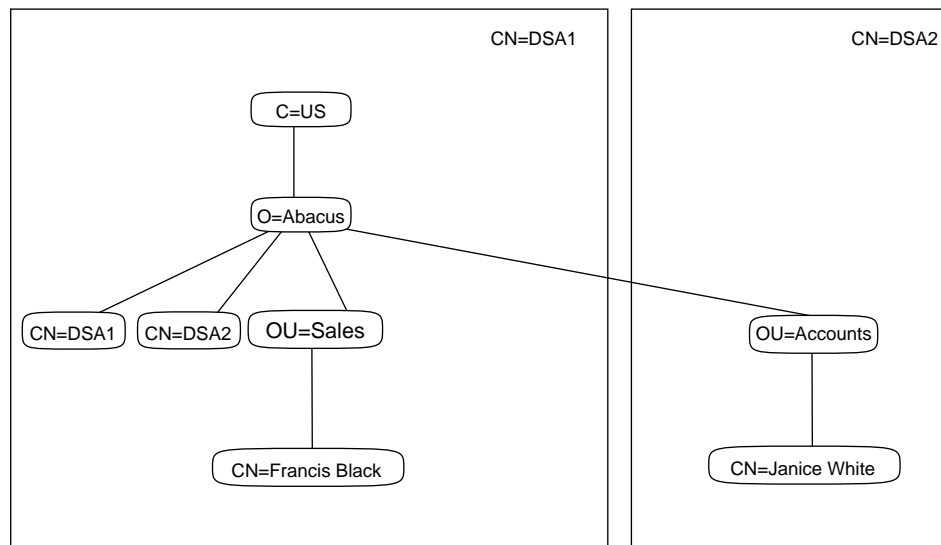

MIG0546

Note that the DSA entries are both held by CN=DSA1; CN=DSA2 does not contain its own directory entry. The physical location of a directory entry is determined by its name, and both of the DSA entries have names that cause them to be created within the /C=US/O=Abacus naming context, which is held on CN=DSA1. There is no requirement for a DSA to hold its own directory entry.

The remaining tasks in this tutorial implement access controls, replication, and Lookup Client. There is also a section showing you how to experiment with the example Enterprise Directory, showing how access controls affect your ability to see and modify directory information.

## 3.9 Setting Up Access Controls

By default, all users of the Enterprise Directory can modify entries and read information from entries. Indeed, in Section 3.7 you created several entries. The only restriction enforced by the two DSAs, by default, is that they do not allow you to display password attributes.

Typically, you will want to set up some additional access controls. This section shows how to set up access controls that make Francis Black a directory manager with the right to modify all entries.

Note that system or superuser privileges do not provide privileged access to directory information. The Enterprise Directory uses its own mechanism for determining what access rights a user has, and applies this mechanism regardless of the account or operating system the user is using, or whether the user is remote or local to the DSA.

To help you set up some simple access controls, the Directory Service provides the following access control template file.

Tru64 UNIX	/var/dxd/scripts/dxd_aci_template.dxim
	◆
OpenVMS	DXD\$DIRECTORY:DXD\$ACI_TEMPLATE.DXIM
	◆

The template file contains two incomplete DXIM commands. Make a copy of the file so that when you have completed this tutorial, you can return it to its original state.

In order to set up the access controls, you need to complete the commands in the template file, and then use DXIM to execute them, as follows:

1. Use the search function of your editor to locate the following string in the template file:

```
create entry
```

2. Edit that line, as follows:

```
create entry
```

becomes:

```
create entry /C=US/O=Abacus/CN="Access Controls" -
```

Do not delete the - character from the end of the line; it is a command continuation character that permits a command to be specified over several lines.

3. Locate the following string:

```
set entry
```

4. Edit that line, as follows:

```
set entry
```

becomes:

```
set entry /C=US/O=Abacus/CN="Access Controls" -
```

Be careful not to delete the - character from the end of the line.

## Multi-Node X.500 Implementation Tutorial

### 3.9 Setting Up Access Controls

5. Locate the following string:

```
user names
```

6. Edit that line as follows:

```
user names      -
```

becomes:

```
user names /C=US/O=Abacus/OU=Sales/CN="Francis Black" -
```

Be careful not to delete the - character from the end of the line.

This is the line that declares Francis Black to be a directory manager. Only the name specified in this clause will be recognized by the DSAs as being the name of a directory manager. The absence of Janice White's name from this clause means that she will not have the same access rights as Francis Black.

7. Execute the template file, as follows:

```
Tru64
UNIX  $ dxim do /var/dxd/scripts/dxd_aci_template
      ◆
```

```
OpenVMS $ DXIM DO DXD$DIRECTORY:DXD$ACI_TEMPLATE.DXIM
        ◆
```

Section 3.11 shows how the access controls affect the ability of Francis Black and Janice White to access information in the DIT.



## 3.10 Replicating Information Between the Two DSAs

This section describes how to implement replication, so that both DSAs have copies of each other's information.

The NCL commands need to be issued from a privileged account. See previous sections for details of how to invoke the NCL director.

1. Implement replication of the naming context called `/C=US/O=Abacus` from `CN=DSA1` to `CN=DSA2`.
  - i Configure the `/C=US/O=Abacus` naming context so that `CN=DSA2` is listed as a consumer, as follows:

```
NCL> ADD DSA NAMING CONTEXT "/C=US/O=Abacus" -
_NCL> CONSUMER ACCESS POINT={ [ AE TITLE="/C=US/O=Abacus/CN=DSA2", -
_NCL> PRESENTATION ADDRESS='<address>' ] }
```

where `<address>` is the presentation address of `NODE_2`, which you made a note of in Section 3.3. Note that you must quote the presentation address using `' '` characters, as shown.

Adding the Consumer Access Point attribute causes `CN=DSA1` to attempt to replicate the naming context to `CN=DSA2`. However, at this point, `CN=DSA2` rejects this attempt because it cannot verify the identity of `CN=DSA1`. This rejection not a problem. It would be insecure to accept replicated information from a DSA whose identity cannot be verified.

- ii Use the following NCL command on `NODE_2`:

```
NCL> UPDATE DSA SUPPLIER '<address>'
```

where `<address>` is the presentation address of `CN=DSA1`, which you made a note of in Section 3.3.

This causes `CN=DSA2` to connect to `CN=DSA1` and initiate the first update. This can succeed because `CN=DSA1` can verify the identity of `CN=DSA2` because it holds a copy of the directory entry representing `CN=DSA2`. `CN=DSA1` can compare the password provided by `CN=DSA2` with the password in the directory entry. If you completed the configuration accurately, the passwords match, and `CN=DSA1` is satisfied that the replication request really does come from `CN=DSA2`.

Having checked the password, `CN=DSA1` provides `CN=DSA2` with a copy of the `/C=US/O=Abacus` naming context. This naming context includes the two entries representing the two DSAs. This means that the two DSAs can now verify each other's identities.

2. Implement replication of the `/C=US/O=Abacus/OU=Accounts` naming context from `CN=DSA2` to `CN=DSA1`.
  - i Configure the `/C=US/O=Abacus/OU=Accounts` naming context so that `CN=DSA1` is listed as a consumer, as follows:

```
NCL> ADD DSA NAMING CONTEXT "/C=US/O=Abacus/OU=Accounts" -
_NCL> CONSUMER ACCESS POINT={ [ AE TITLE="/C=US/O=Abacus/CN=DSA1", -
_NCL> PRESENTATION ADDRESS='<address>' ] }
```

where `<address>` is the presentation address of `CN=DSA1`, which you made a note of in Section 3.3. Note that the presentation address must be quoted using `' '` characters, as shown.

## Multi-Node X.500 Implementation Tutorial

### 3.10 Replicating Information Between the Two DSAs

Adding the Consumer Access Point to the Naming Context entity causes CN=DSA2 to attempt to replicate the naming context to CN=DSA1. This succeeds because CN=DSA1 holds the entry representing CN=DSA2, and can therefore check CN=DSA2's password, and verify its identity. CN=DSA2 therefore provides CN=DSA1 with a copy of the /C=US/O=Abacus/OU=Accounts naming context.

No UPDATE DSA command is required in this case.

Now that replication has been implemented, and the two DSAs are able to verify each other's identities, future replications happen without management intervention. Every twelve hours the two DSAs automatically communicate to keep the replicated information up to date.

You now have a simple, secure, distributed and replicated Enterprise Directory provided by two DSAs. Figure 3-3 shows CN=DSA1 after all of the tasks described above are completed. The shading indicates which information is a copy of information from CN=DSA2.

Figure 3-3 DSA1 After All Tasks Are Completed

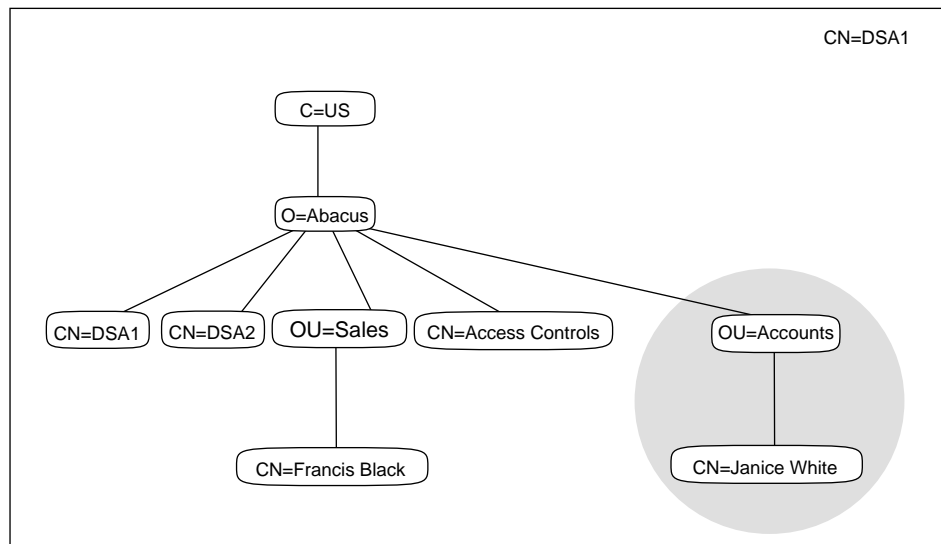

MIG0544

Figure 3-4 shows CN=DSA2 after all the of tasks described above are completed. The shading indicates which information is a copy of information from CN=DSA1.

## Multi-Node X.500 Implementation Tutorial

### 3.10 Replicating Information Between the Two DSAs

Figure 3-4 DSA2 After All Tasks Are Completed

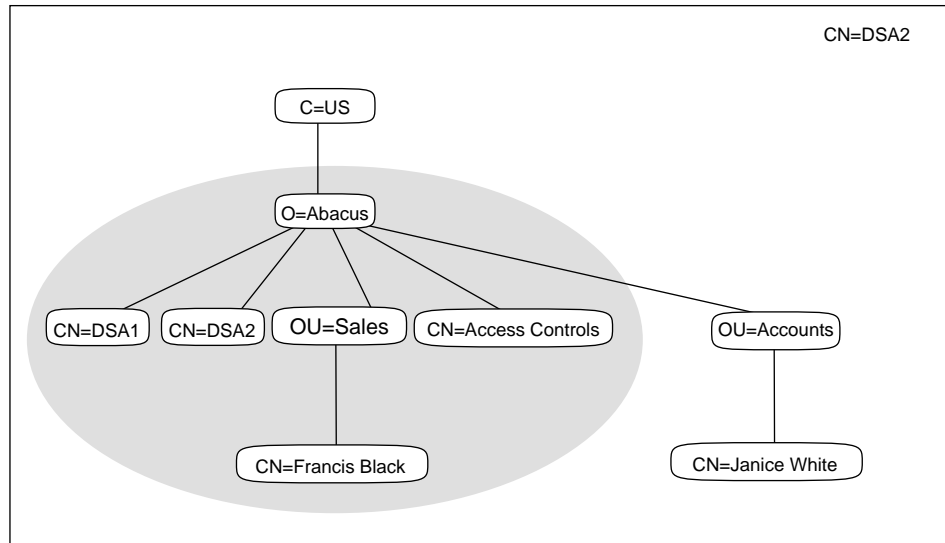

MIG0545

Note that the entry called /C=US is not included in the shaded area. This is because that entry is not part of the Abacus information tree. An organization such as Abacus should not claim ownership of entries representing countries. Such entries form part of the global directory infrastructure, and should be owned and managed by national authorities. This is explained in more detail in Chapter 4.

## Multi-Node X.500 Implementation Tutorial

### 3.11 Experimenting with the Example Enterprise Directory

### 3.11 Experimenting with the Example Enterprise Directory

This section shows how to use DXIM to access information in the example Enterprise Directory. It demonstrates some of the commands available to the user, and shows how access is controlled for different users.

1. Invoke DXIM from an account on either system. No privileges are required.

```
Tru64
UNIX
```

```
$ dxim -c
```



```
OpenVMS
```

```
$ DXIM /INTERFACE=CHARACTER_CELL
```



2. Type the following commands, and look at their output:

```
dxim> show /C=US/O=Abacus/OU=Sales/CN="Francis Black"
```

```
dxim> search where surname=Black all attributes
```

```
dxim> search where surname=White all attributes
```

Note that the password attribute is never displayed. That attribute is protected by access controls.

3. Type the following command:

```
dxim> modify /C=US/O=Abacus/OU=Sales/CN="Francis Black" -
_dxim> add attribute title=Manager
```

The access controls set up in Section 3.9 cause this command to return an error. The entry is not modified.

This is because the access controls state that the ability to modify entries is restricted to particular users. So far, you have not authenticated, that is, you have not specified a name and password, so the Enterprise Directory does not know who you are.

4. Use the following command to make a new, authenticated connection to the Enterprise Directory:

```
dxim> bind Link2 name /C=US/O=Abacus/OU=Sales/CN="Francis Black" password
Password> TANGERINE
```

Link2 becomes the default binding. Remember to use upper case for the password.

5. Now repeat the MODIFY command as follows:

```
dxim> modify /C=US/O=Abacus/OU=Sales/CN="Francis Black" -
_dxim> add attribute title=Manager
```

This time, the command should succeed, because the DSA recognizes you as being a directory manager, with permission to modify entries. Similarly, try the following command:

```
dxim> modify /C=US/O=Abacus/OU=Sales/CN="Francis Black" -
_dxim> add attribute description="Directory Manager"
```

This succeeds as well, demonstrating that Francis Black can modify both the **description** and **title** attributes. In fact, Francis Black can modify all attributes in all entries. You can even create and delete entries when you are authenticated as Francis Black.

## Multi-Node X.500 Implementation Tutorial

### 3.11 Experimenting with the Example Enterprise Directory

6. Use the following command to make another new connection to the Directory Service:

```
dxim> bind Link3 name /C=US/O=Abacus/OU=Accounts/CN="Janice White" password
Password> CLEMENTINE
```

If you specified the name and password correctly, the BIND command succeeds. If not, try again. Remember to use upper case for the password.

7. Now that you have authenticated as Janice White, try another modification, as follows:

```
dxim> modify /C=US/O=Abacus/OU=Accounts/CN="Janice White" -
_dxim> add attribute description="Accountant"
```

This succeeds. However, the following command fails, even though you are authenticated as Janice.

```
dxim> modify /C=US/O=Abacus/OU=Accounts/CN="Janice White" -
_dxim> add attribute title=Accountant
```

This demonstrates that, even when authenticated, Janice has less access than Francis. Janice can change her description, but not her title. Furthermore, Janice's ability to modify descriptions applies only to her own entry. If she attempts to change Francis' description, she would fail. Meanwhile, Francis can modify descriptions in any entry, not just his own.

So, Janice has limited modification access to her own entry, and no other entry, whereas Francis has unlimited modification access to all entries.

There are now three connections between DXIM and the Enterprise Directory.

- Link1 is an anonymous link; no name or password was specified. Link1 was created by default when you issued the first DXIM command.
- Link2 is an authenticated link; the name and password of Francis Black are associated with this link.
- Link3 is an authenticated link; the name and password of Janice White are associated with this link.

DXIM maintains all three links, and allows you to switch between them. Each link has a different level of access to directory information. For example, you can make Link2 the default link as follows:

```
dxim> set default binding Link2
```

You can display a list of current bindings using the SHOW BINDING command. The list shows information about each binding, including the address of the DSA, the name supplied by the user, and whether the user supplied a password.

8. Use the DXIM help to see what other commands are possible, and experiment with those. For example, use the CREATE and DELETE commands.

---

#### Note

---

Do not delete the Francis Black entry. It represents the only user who can manage entries in this example. If you accidentally delete the entry, recreate it immediately using Link2.

---

Note how creations and deletions only succeed if you are using Link2.

9. Use the DXIM windows interface to view the entries.

## Multi-Node X.500 Implementation Tutorial

### 3.11 Experimenting with the Example Enterprise Directory

To invoke the DXIM windows interface, type:

```
$ dxim
```

DXIM displays the Find window. A Browse window is also available from the Directory menu. Use these two windows to display entries in the Abacus DIT.

Note that if you try to modify entries, you are prevented by access controls.

10. Use the Authenticate option of the Directory menu to specify the name and password of Francis Black.

Now that you are authenticated as Francis Black, modifications are possible.

When you have finished experimenting with the DXIM interfaces, exit from them and proceed to the next section of this tutorial.

### 3.12 Using the Lookup Client

To start the Lookup Client graphical interface, type the following command:

```
Tru64  
UNIX # dxdlu  
◆
```

```
OpenVMS $ RUN SYS$SYSTEM:DXD$LOOKUP_MOTIF.EXE  
◆
```

Type **Francis Black** into the input field and press Return to invoke a search. The Lookup Client displays the entry representing Francis Black. Refer to the Help menu for further details on how to use the Lookup Client.

## Multi-Node X.500 Implementation Tutorial

### 3.13 Deleting the Example Enterprise Directory

### 3.13 Deleting the Example Enterprise Directory

Now that you have some experience of the tasks involved in setting up an Enterprise Directory, delete the example configuration, and read the planning and implementation chapters of this book.

To delete the example Enterprise Directory configuration, log in to a privileged account, and use the NCL director to disable and delete the DSA on each node, as follows:

```
NCL> DISABLE DSA
```

```
NCL> DELETE DSA
```

Then delete the database files and the defaults files on both systems, as follows:

```
Tru64  
UNIX  
# rm /var/dxd/DSA-information-tree*  
# rm /etc/dua.defaults  
# rm /etc/dxdlu.defaults  
◆
```

```
OpenVMS  
$ DELETE DXD$DIRECTORY:DSA-INFORMATION-TREE.*;*  
$ DELETE DXD$DIRECTORY:DXD$DUA_DEFAULTS.DAT;*  
$ DELETE SYS$SYSTEM:DXDLU.DEFAULTS;*  
◆
```

Deleting the database files means that the DSA is returned to its unconfigured state, as it was when you first installed the software. The DSA stores its configuration information and its entries in these files.

You should also delete the access control template file you created in Section 3.9, and copy back into the correct position the original template file. If you no longer have an original copy of the template file, you can copy it from another system, or reinstall the X.500 Base subset, or edit the file back to its original state.



# Part II

---

## Planning

This part explains the planning tasks required to design your directory information and to establish your Enterprise Directory.

- Chapter 4 describes how to plan your directory information tree, and how to plan entries to represent your Compaq DSAs.

This chapter is essential reading.

- Chapter 5 describes how to plan the distribution and replication of directory information for your DSAs.

This chapter is essential reading, although if you only have one DSA you might be able to miss some sections.

- Chapter 6 describes how to plan customizations for your schema.

This chapter is not required if the default schema meets your requirements. Some types of schema change can be planned and implemented after you have created your directory information. However, some cannot, so if you think that you might ever need to customize the schema, you are advised to read this chapter before creating directory information.

- Chapter 7 describes how to plan access control for your information.

This chapter is not required if you do not need to control access. Access controls can be implemented at any time, so you might decide not to read this chapter until some time after planning and implementing the features described in Chapter 4, Chapter 5, and Chapter 6.



---

## Planning Your Directory Information Tree

This chapter explains how to approach the task of designing a Directory Information Tree (DIT) for your organization. Planning a DIT in advance is advisable for implementing a usable and efficient Enterprise Directory.

Compaq strongly recommends that your organization sets up a management team to design your DIT. Over time, your Enterprise Directory will affect more and more users and applications, and X.500 directory names will become increasingly common in user interfaces.

When you are planning what information to represent in the directory, remember to consider any data protection legislation that might influence your choices. This is especially important if you intend to store information about people. Many countries have laws that restrict your right to store information about people.

---

### Note

---

Some Enterprise Directory applications might have very specific information requirements. For example, some applications require directory names to conform to certain naming conventions. Ideally, applications should not impose such requirements on directory information, they should simply accept whatever names you assign to entries.

However, if you have such an application, treat it as a special case, and refer to that application's documentation for details of how to plan X.500 information. The MAILbus 400 Message Transfer Agent (MTA) is an example of an application that requires very specific directory information, and that product includes documentation explaining what you need to do. If the only reason you are using X.500 is to support the MTA, then all the directory information planning tasks are described in the MTA documentation.

If you build an X.500 application, do not implement dependencies on specific naming conventions. Refer to the *Compaq Enterprise Directory for Business Programming* for advice on implementing X.500 applications.

---

The advice in this chapter explains how to design information that is of general use. Most importantly, this guide explains how to design information for use by your organization's employees. For this reason, the advice in this guide encourages you to design a user friendly naming scheme, so that when your users search the directory for information, they will not need to learn special naming conventions first.

## Planning Your Directory Information Tree

Your goal is to plan a DIT that represents the hierarchy and geography of your organization, and enables you to name anything within your organization, and to provide each entry with the range of attributes that it requires. A good DIT design is one that gives each entry a name that is relatively easy to remember and use, and that is consistent with other entry names.

---

### Note

---

The advice in this chapter helps you represent objects *within* your organization. You should not attempt to represent objects that are not within your organization and do not belong to you. Specifically, you should not try to represent countries using the `country` class. Such entries do not belong in your organization's DIT.

Your task is to design a DIT that has an entry representing your organization at its root. It may be that your DIT is itself going to be a subtree of a larger DIT; but if so, any entries that are hierarchically superior to your organization are not your responsibility. Such superior entries are the responsibility of a national or regional naming authority such as ANSI or the British Standards Institute.

The advice in this chapter applies regardless of whether such superior entries exist. Section 4.3 describes extra tasks that you need to do after the planning described in this chapter if such entries do exist.

---

Your first planning task is to design a structure similar to one of Figure 4-1 or Figure 4-2 or Figure 4-3. Figure 4-1 illustrates a structure based on the organizational hierarchy of a fictional organization. The fictional Abacus organization is used throughout this guide to illustrate planning tasks. Figure 4-2 illustrates a structure based on geographical distribution, and Figure 4-3 illustrates a structure that combines both geographical and organizational elements.

Which of these structures you use depends on your organization, and you can use different structures for different parts of your organization if that seems most appropriate.

## Planning Your Directory Information Tree

Figure 4–1 A DIT Based on Organizational Units

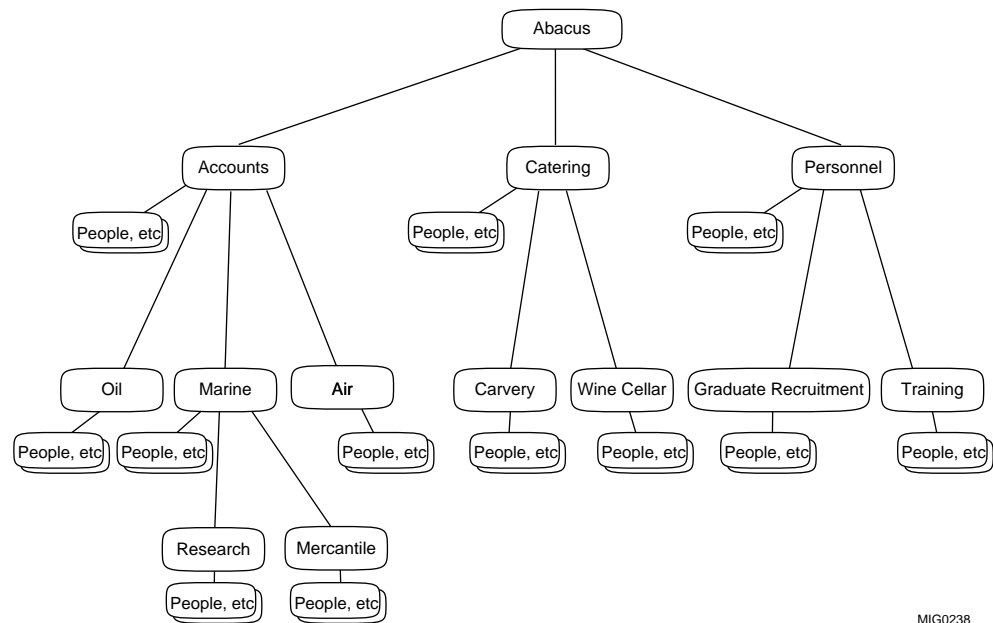

Figure 4–1 illustrates a DIT that includes the following entries:

- An entry representing the whole organization (Abacus).
- Many entries representing the groups or divisions within your organization (Accounts, Oil, Catering, and so on).

In some parts of the DIT there are two or three levels of organizational unit. A unit that is represented beneath another unit is a subdivision of that unit, or a dependent group. In this way, the DIT reflects the hierarchical structure of your organization.

- Many other entries representing employees, computers, and other resources (shown as "People, etc").

These entries are subordinate to the organizational units that own or control them.

## Planning Your Directory Information Tree

Figure 4–2 A DIT Based on Geographical Distribution

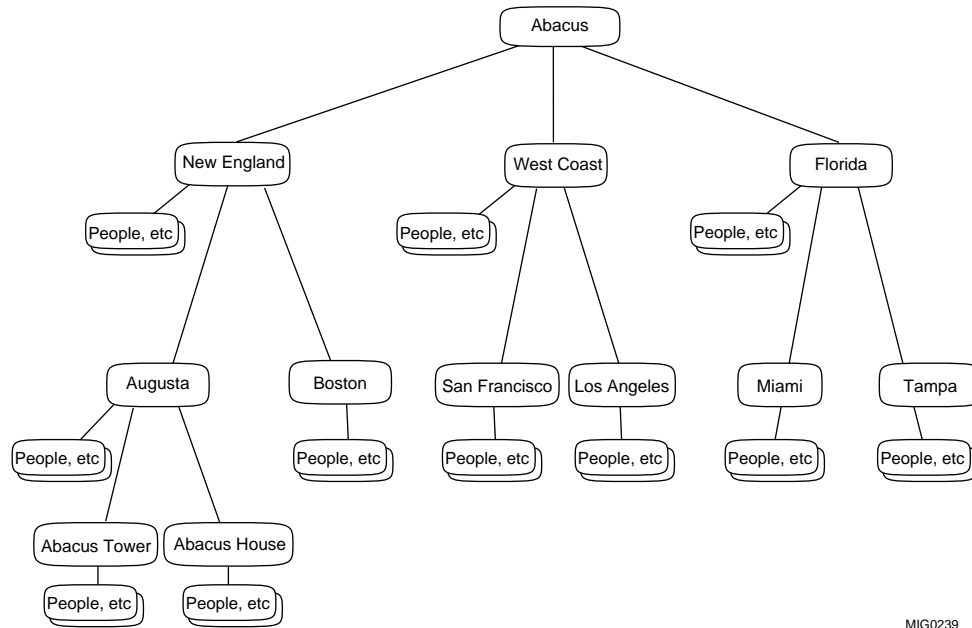

MIG0239

Figure 4–2 illustrates a DIT that includes the following entries:

- An entry representing the whole organization (Abacus).
- Many entries representing the geographical localities in which the organization is based.

The localities could be cities, states, provinces, or buildings depending on the size of the organization and the familiarity of those localities to users. Localities can be subdivided into further localities. For example, New England is subdivided into Boston and Augusta, the latter being further subdivided into Abacus Tower and Abacus House, the two major office developments that the organization has in Augusta.

- Many entries representing employees, computers, and other resources. These entries are subordinate to the localities that own or control them.

# Planning Your Directory Information Tree

Figure 4–3 A DIT Based on Geographical and Organizational Elements

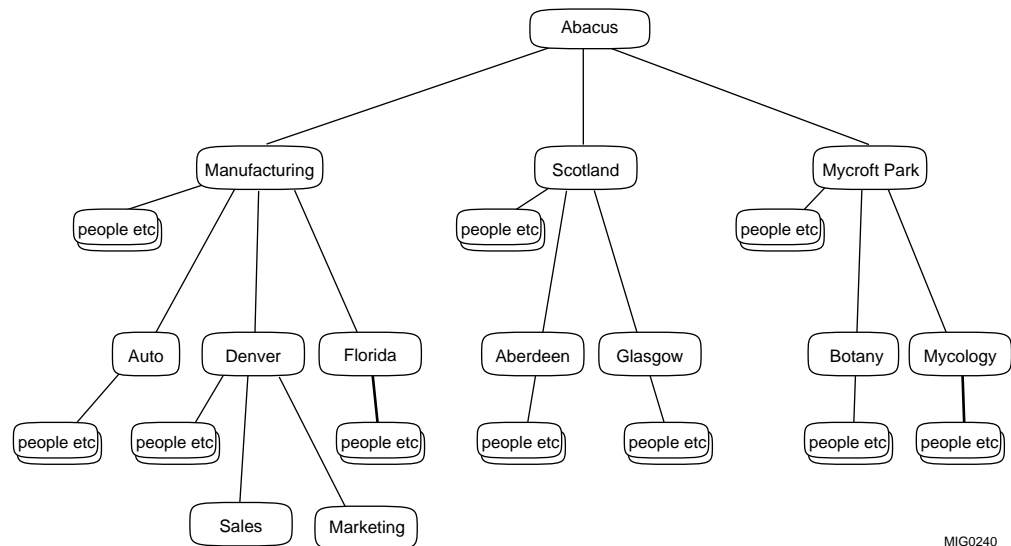

MIG0240

Figure 4–3 illustrates a DIT that includes the following entries:

- An entry representing the whole organization (Abacus).
- Many entries representing localities in which parts of the organization are based.  
Some localities are subordinate to entries representing groups or divisions within the organization, indicating that those groups are based in more than one locality.
- Many entries representing the groups or divisions within the organization.  
Some of these groups and divisions are subordinate to locality entries, representing that they are based in the relevant locality.
- Many entries representing employees, computers, and other resources.  
These entries are subordinate to the organizational units or localities that own or control them.

You need to analyze your organization to decide how best to represent it. Note that at this stage, you do not need to consider what classes of entry you will use to represent the various entries; you simply need to sketch a structure that divides your organization into manageable groupings of resources.

Section 4.1 describes the factors that influence this design task, and helps you decide what DIT structure to use.

## 4.1 DIT Planning Considerations

Designing your organization's DIT is the most important of the planning tasks, because it is difficult to restructure your DIT once you have implemented it. The following sections describe several factors that you must consider when planning the DIT, some of which might tend to conflict with each other. Some sections indicate that the advice conflicts with the advice in other sections. Your task is to design a DIT that provides the best compromise, for your organization, of all the conflicting considerations.

## Planning Your Directory Information Tree

### 4.1 DIT Planning Considerations

#### **Use a Familiar Structure**

Try to represent your organization in a way that is familiar to the human users of the Enterprise Directory (assuming you intend to allow your employees to use the directory).

By using a familiar hierarchy, you make it easier for users to use the service efficiently, as they can direct their requests towards particular subtrees. For example, a user searching for another user's entry could be aided by the fact that the directory divides the organization into geographical localities, with which the user is familiar.

Names based on a familiar hierarchy will also be easier to remember from one occasion to the next. If your organization already has a naming scheme for identifying resources and employees, then you can use that scheme as input to the DIT design, although organizational charts are often far more detailed than your DIT needs to be.

Existing naming policies or organizational charts might influence whether you decide to use organizational or geographical elements in your DIT. Also, if you are considering using a mixture of geographical and organizational elements, then bear in mind that this tends to conflict with user friendliness, as users have to guess which type of element is actually being used in the part of the DIT that they are trying to search. Your users will find names easier to use and remember if they are constructed of a predictable and consistent set of components.

#### **Use a Stable Structure**

Try to represent your organizational structure in a way that is unlikely to change.

Once you have implemented a naming tree, it is difficult to revise it (although you could delete all entries and start again, or use alias entries to give the appearance of a different structure). Also, any redesign of the DIT changes the names of entries, so your users will be less likely to remember them, or to know where in the tree to look for particular information. Therefore, if your organization often reorganizes its structure, try to use structural features of your organization that are least likely to change.

The need for DIT stability might influence whether you use geographical and/or organizational elements in your DIT. In some organizations it might be common for employees to change group many times without having to relocate, in which case it makes sense to name people according to their location rather than their organizational unit. In other organizations, it might be more common for organizational units to relocate such that the organizational structure is stable, but the location of its groups is unstable. In that case, geographical details are of little lasting use in your DIT.

#### **Use a Structure that Accommodates Resource Mobility**

Try to divide your organization into subdivisions in which resources tend to stay for long periods.

If your employees and other resources move from group to group or location to location frequently, then there is a danger that you will need to do a lot of modifications to their entries. If you use units that resources stay in, you can reduce the amount of management required to keep the information up to date. One way to achieve this objective is to avoid dividing your organization into too many subdivisions.



## Planning Your Directory Information Tree

### 4.1 DIT Planning Considerations

For example, an engineer can be expected to remain in the Engineering part of the business, but to move between different engineering projects. If you use a structure that includes units for each project, then the engineer's entry might need frequent modification. If you simply place all engineers beneath an entry representing Engineering as a whole, the engineer's entry need not be modified after each move.

Figure 4-4 illustrates part of a DIT in which an Engineering unit is subdivided into a number of smaller units, whereas a Sales unit is not subdivided. There is an engineer called Jane working for the hardware engineering group, and a salesman called Bill working for the hardware sales group. If Jane moves from hardware engineering to software engineering and then to office products engineering she would require her directory entry to be moved from unit to unit accordingly. However, if Bill moves from hardware sales to software sales and then to office products sales he would not require any modification to his entry, because it simply identifies him as an employee of Sales generally.

**Figure 4-4 Accommodating Resource Mobility**

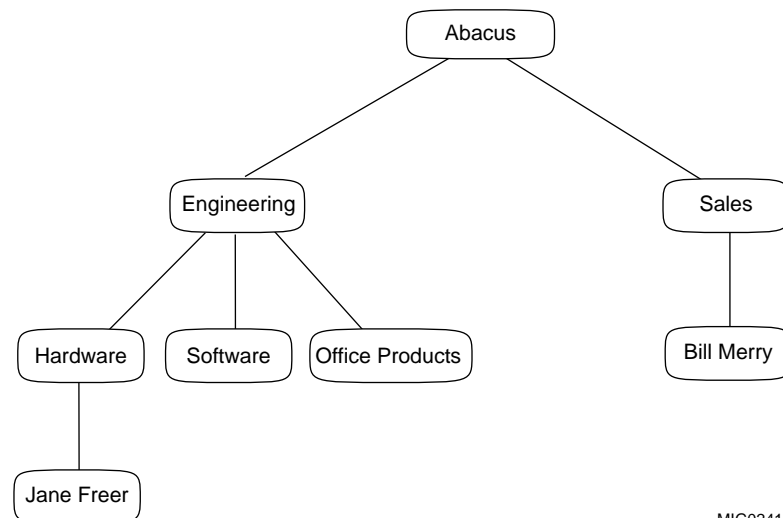

MIG0241

The part of the DIT representing Sales therefore minimizes the effect of resource movement within the organization. Bill's entry would only need modification if Bill left the Sales unit altogether. However, note that this advice tends to conflict with the advice about avoiding name clashes, as well as the advice about dividing the DIT into manageable portions (as described in the following subsections).

---

#### Note

---

Limiting the amount of detail in your DIT hierarchy does not prevent you from representing further organizational and geographical detail in another way.

Any organizational or geographical details that you exclude from the DIT hierarchy can be represented as attributes within each entry, as described in Section 4.1.1. Thus, Bill's entry could include an `organizationalUnitName` attribute that indicates which part of Sales he works for. Modifying such an attribute within an entry is far easier

## Planning Your Directory Information Tree

### 4.1 DIT Planning Considerations

than amending the structure of the DIT itself, or moving an entry from one part of the DIT to another.

---

#### **Use a Structure that Divides the DIT into Manageable Portions**

The easiest way to divide the management responsibility for the DIT is to assign managers to particular subtrees of the DIT. For example, to manage the DIT shown in (Figure 4–4), you could have two DIT management teams; one for the Engineering entry and all of its subordinates, and the other for the Sales entry and all of its subordinates. Alternatively, you could have one management team for each of the three engineering subdivisions and one for the Sales unit.

Dividing your DIT into manageable portions may conflict with the advice about using few levels of hierarchy and about coping with resource mobility.

#### **Use a Structure that Minimizes Name Clashes**

Try to design a DIT that divides your organization into groupings of entries that cause as few name clashes as possible.

A name clash occurs when two or more entries require the same directory name. Every distinguished name must be unique, so, for example, if you have several John Smiths working for the same organizational unit, you have a name clash to resolve. Try to divide your organization so that organizational units are small enough for such clashes to be rare. (You can never completely avoid the possibility of name clashes, and Section 4.4.1 explains how to resolve them when they occur.)

Dividing your organization into small units to reduce the chance of name clashes might conflict with the advice about using few levels of hierarchy and trying to cope with resource mobility.

#### **Use Few Levels of Hierarchy**

Try to use as few levels of hierarchy as possible. Each entry's distinguished name is made up of the RDNs of all the entries directly above it in the DIT. Therefore, entries a long way down the hierarchy tend to have very long distinguished names. The most useful entries tend to be the ones at the lowest levels of the DIT, and therefore are the ones with the longest names. Long names are hard to remember and use, so a shallow hierarchy tends to be more usable.

You should avoid representing your organization in too much detail, with many levels of organizational or geographical unit. A common mistake is to design DITs which have many levels of organizational entry, so that entries' names are useful information in their own right. This approach makes names longer, harder to memorize, less stable, and requires more processing for each attempt to find entries. A hierarchy with few levels provides shorter names that are likely to be more stable and manageable, and easier to remember.

Therefore, when you are analyzing your organizational structure and distribution, avoid including every tiny detail. Only subdivide a given unit if it will make the DIT more manageable or help minimize the probability of name clashes.

---

#### **Note**

Limiting the amount of detail in your DIT structure does not prevent you from representing further organizational or geographical details in another way. Section 4.1.1 explains how to represent details of a resource's organizational and geographical position without creating several levels of entry.

---

## Planning Your Directory Information Tree

### 4.1 DIT Planning Considerations

When deciding how many levels of entry to implement, there is no requirement for your DIT to be symmetrical: one part of your DIT can have more levels of entry than another.

#### **Avoid Using a Confidential Structure**

Remember that if you connect your organization's X.500 Enterprise Directory to other X.500 Directory Services, the names of your entries will be visible to people outside of your organization.

Therefore, use an organizational structure that you do not mind being exposed to external organizations. For example, if you have a design department that includes groups working on sensitive projects, you might prefer not to subdivide your DIT beyond the level of the design department.

#### **4.1.1 Representing Hierarchy as Attributes of an Entry**

When you design your DIT, you might want to include several levels of organizational unit or geographical division so that an entry's position in the DIT is fully representative of a resource's position in your organization. However, as Section 4.1 explains, there are several reasons why you should not represent your organizational hierarchy in too much detail. Instead, you can use attributes of a given entry to represent organizational or geographical details.

For example, instead of creating a detailed hierarchy of entries representing organizational units or geographical areas as superiors of an entry representing an employee, you could use the optional `organizationalUnitName` and `localityName` attributes within the employee's entry itself. The effect of this would be to reduce the depth of your DIT, as illustrated in Figure 4-5.

## Planning Your Directory Information Tree

### 4.1 DIT Planning Considerations

Figure 4–5 Two Ways to Represent Organizational and Geographical Details

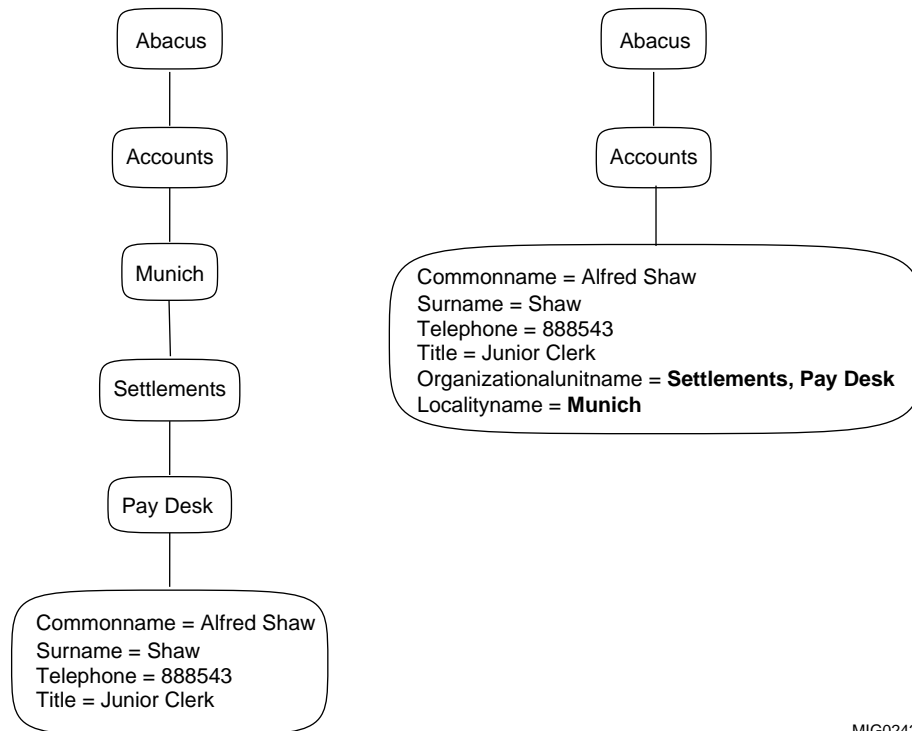

MIG0242

The example on the left represents all organizational units and localities as entries in their own right, and the entry representing Alfred Shaw includes attributes for his surname, title, and telephone number. The example on the right places Alfred's entry beneath only one organizational unit entry, and all the other details are represented as attributes of his entry, along with his surname, telephone number, and title. In the example on the left, Alfred's entry has five superior entries, whereas on the right, Alfred's entry has only two superior entries. Therefore, the distinguished name of the entry on the left would be longer than that of the entry on the right.

Compaq recommends that you follow the example on the right, so that you can implement a DIT with as few levels of hierarchy as possible. When you have made a rough plan of how to represent your organization, review it to see whether all of the levels of hierarchy and geography are really necessary. Remember that not all users are equally familiar with the hierarchical structure of different parts of your organization. Avoid using levels of hierarchy that are unfamiliar to users, since this does not help them to find information.

## 4.2 Choosing Classes to Represent Objects

Having decided how to represent your organizational hierarchy, you need to plan exactly how to represent the organizational divisions and resources as X.500 directory entries. When you create an entry, you must specify what class of entry it is. The class of an entry determines what attributes it can have.

## Planning Your Directory Information Tree

### 4.2 Choosing Classes to Represent Objects

You need to choose a **structural class** that provides the attributes appropriate to each type of object. A structural class is a class that provides the basis of an entry. All entries must belong to a structural class, and once created cannot be modified to belong to any other structural class.

Your planning task is to decide which of the structural class definitions in the schema best represents each of your objects. If there is no structural class suitable for a given type of object, then you need to define a new structural class. However, for several types of object, the international standards bodies have provided useful definitions. By using these predefined structural classes, you improve your ability to interwork with other organizations' Enterprise Directories.

The predefined structural classes are probably not perfect matches for the information that you require, but they provide a good foundation. You can then define **auxiliary classes** which enable you to use extra attributes that are not defined for the structural classes. An entry can belong to more than one auxiliary class, in addition to its structural class.

For example, the predefined structural class `organizationalPerson` permits you to use several attributes that the standards bodies considered would be useful. However, it is likely that your organization has some information that it would like to store about people, for which this structural class does not allow. You can therefore define an auxiliary class that permits the use of those extra items, and use the auxiliary class with the structural class. Chapter 6 explains this option in more detail.

The following list explains which structural class from the default schema is most suitable for a given type of object:

- Your organization as a whole can be based on the `organization` class.
- Geographical areas can be based on the `locality` class.
- Groups and divisions within your organization can be based on the `organizationalUnit` class.
- Your employees can be based on the `organizationalPerson` class.
- Computer hardware can be based on the `device` class.
- Open system application processes and entities can be based on the `applicationProcess` and `applicationEntity` classes.
- Compaq strongly recommends that you represent your DSAs using entries of the `decDSA` class.

You need to represent all of your Compaq DSAs as directory entries. Entries representing DSAs are used for Enterprise Directory security, and for distributed directory operations.

- Some organizations might find that the `residentialPerson` class is useful for representing employees who work from home, or perhaps for representing customers. For example, a telephone company might represent subscribers using this class.

If you have objects that do not fall into any of the above categories of object, then you will need to define some completely new structural classes. Defining structural classes is a complex task, so use standard definitions if at all possible. Chapter 6 describes how to define a structural class.

## Planning Your Directory Information Tree

### 4.2 Choosing Classes to Represent Objects

When you choose classes to represent your objects, refer to the schema definitions for details of permitted structural rules between classes of entry. For example, there is a structure rule that states that an `organizationalPerson` entry is only permitted beneath entries of the `organizationalUnit`, `locality`, or `organization` classes.

If you have planned your DIT according to the advice at the beginning of this chapter, then you should find that the definitions do permit the hierarchy that you want. If not, you need to reassess your DIT hierarchy so that it does not conflict with the structure rules, or else to redefine the schema so that a different set of structural rules is allowed. For ease of implementation, Compaq recommends that you use the structural rules permitted by the default schema, because redefining structure rules is complicated.

Figure 4-6 illustrates the structure rules that Compaq recommends you to use within your organization's DIT. There are further possible relationships between these classes, which are illustrated in Appendix A. However, you should find that the relationships illustrated in Figure 4-6 are sufficient.

**Figure 4-6 The Most Frequently Used Default Structure Rules**

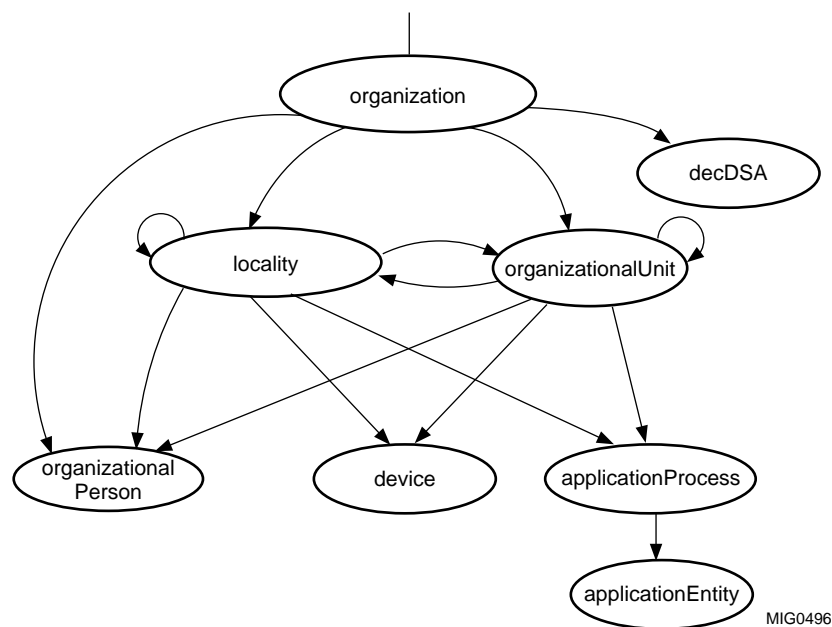

Each arrow in Figure 4-6 represents a permitted relationship between entries, such that the arrow points from a class of entry to a permitted subordinate of that class of entry. For example, an `organizationalPerson` entry is permitted as a subordinate of an `organization` entry, or an `organizationalUnit` entry, or a `locality` entry. There are no permitted subordinates of an `organizationalPerson` entry. Note that `organizationalUnit` and `locality` have arrows that loop back to themselves. This represents the ability of entries of those classes to be superior to further entries of the same classes, permitting distinguished names such as `/C=US/O=Abacus/OU=Sales/OU=Metals/CN="Jo Brownly"`.

### 4.3 Positioning Your Directory Information Tree into a Global Context

The DIT that you plan for objects within your organization is (or will become) part of a larger, global DIT.

By contacting a national or regional authority that is responsible for assigning names within the region in which your organization is based, you can make your DIT part of a global DIT. The role of the authority is to ensure that no two organizations have the same name. All entry names within your organization's DIT can then be guaranteed to be globally unique, and it becomes possible for different organizations to refer to each other's entries without ambiguity.

---

**Note**

---

Many countries do not have national or regional authorities. If your organization is based in an area that has no such authority, then all you can do is make a simple guess as to where your DIT will eventually fit into the global context. It is possible, although inconvenient, to set up your DIT without positioning it in a global DIT, and then amend your DIT. However, if an authority is available, you should refer to it.

If your organization is international, you should refer to the authority that is responsible for the naming in the area in which your organization has its headquarters. You do not need to refer to the authority of every region in which your organization has any interest, although you can do so if you prefer.

---

When you refer to such an authority, they will tell you how your DIT should fit into the global DIT. It is likely that the position of your DIT within the global DIT will mean that your directory entries are all subordinate to an entry representing your country, and perhaps an entry representing a region or state within your country. This means that the distinguished names of all of your organization's entries will include relative distinguished names that are not planned by you.

The names of these superior entries form a global prefix to the names of your entries, and you need to know this prefix before you configure your Enterprise Directory.

For example, the highest entry in the Abacus DIT is called `organizationName=Abacus`. The Abacus organization is based in the United States. The Abacus organization contacts the authority responsible for assigning names in the United States, and are told that the Abacus DIT must be subordinate to an entry called `countryName=US`. Thus, the distinguished name of every entry in the Abacus DIT includes the relative distinguished name `countryName=US`. Figure 4-7 shows the relationship between that country entry and the DIT planned by the Abacus organization.

# Planning Your Directory Information Tree

## 4.3 Positioning Your Directory Information Tree into a Global Context

Figure 4-7 The Abacus DIT with its Global Prefix

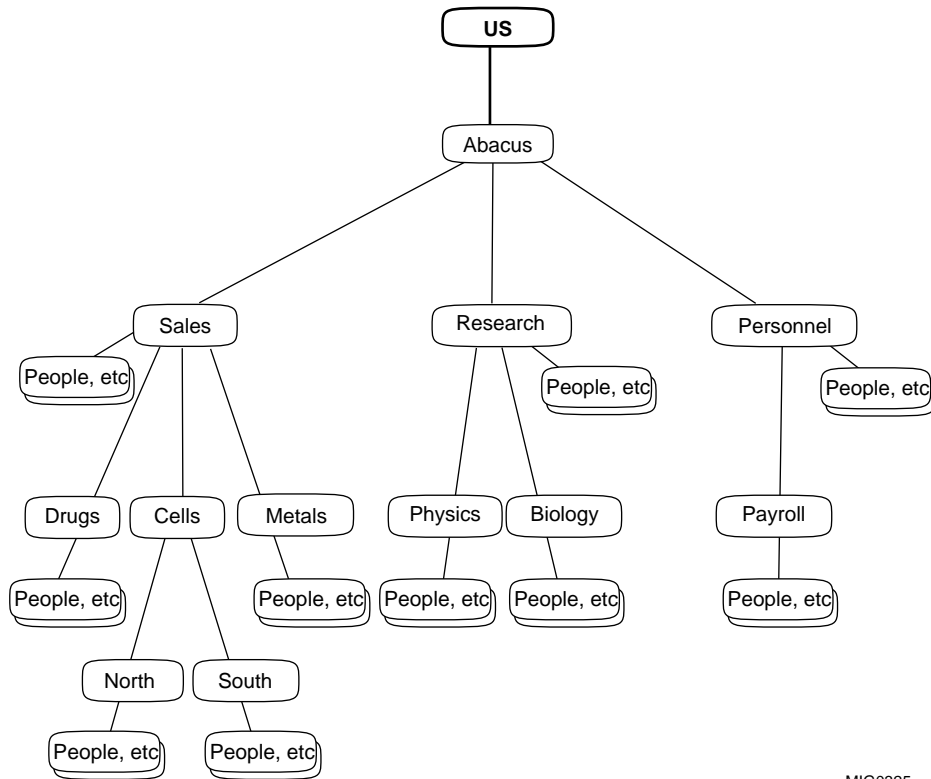

MIG0325

It is important to understand that the country entry is not part of the Abacus DIT, it is only a prefix. When the Abacus organization creates entries, it does not create any entries that are part of the prefix.

In this example, there is only one superior entry to the Abacus DIT, but there could be more. Some authorities will subdivide their country into regions, in the same way as Abacus divided its organization into organizational units and localities. For example, Abacus might have discovered that its DIT was subordinate to an entry called `/C=US/locality=Florida`. Thus, the names of all Abacus entries would include those two relative distinguished names.

When you refer to an authority, you also need confirmation that no other organization in your region has already registered the same organization name.

### Note

Becoming part of a global DIT is, of course, optional. You could decide that your organization does not need any connection to other directories. Even so, Compaq recommends that you refer to a naming authority anyway.

By registering with a naming authority, you make it much easier to become part of a larger DIT later. If you create your DIT without reference to a naming authority, and later decide to join a larger DIT, then it is likely that your entire DIT will have to be renamed.



## Planning Your Directory Information Tree

### 4.3 Positioning Your Directory Information Tree into a Global Context

Planning how your DIT fits into a larger DIT does not force you to become part of the larger DIT immediately.

---

Once you have planned how your organization's DIT fits into the global DIT, and what your DIT's prefix is, you are ready to proceed to Section 4.4, which explains how to name the entries in your DIT.

### 4.4 Naming Your Entries

Having defined a policy for the representation of all types of entry, and planned any new class and attribute definitions that you need, the final task is to define a policy for naming entries as you create them.

When you create an entry, you must specify at least one attribute value to form the entry's RDN<sup>1</sup>. The chosen attribute becomes the RDN of the entry. When you choose the RDN for an entry, there are several things to consider.

Firstly, the definition of the entry's object class states that the RDN must be chosen from particular attributes. For example, the schema's naming rule for the `locality` object class states that the RDN must be a value of the `localityName` attribute. If you try to use any other attribute of the entry, the attempt to create the entry fails.

For most standard classes of entry, the attribute that you use for naming is the `commonName` attribute. Table 4-1 lists the most frequently used exceptions.

**Table 4-1 Naming Attributes of Commonly Used Classes**

Class	Naming Attribute
<code>country[a]</code>	<code>countryName</code>
<code>organization</code>	<code>organizationName</code>
<code>organizationalUnit</code>	<code>organizationalUnitName</code>
<code>locality</code>	<code>localityName</code>
<code>organizationalPerson[b]</code>	<code>commonName</code> and optionally <code>organizationalUnitName</code>
<code>residentialPerson[b]</code>	<code>commonName</code> and optionally <code>streetAddress</code>

*/a/* The class is included for completeness. You should not use this class in your organization's DIT; only as part of your DIT's global prefix (see Section 4.3).

*/b/* This class enables the use of two naming attributes in the RDN. See Section 4.4.1.

Secondly, because the value that you choose is used as part of the distinguished name of the entry, and appears as part of the distinguished name of any entry subordinate to it, you should choose a value that is short and familiar to users. For example, if you want to create an entry to represent the locality Massachusetts, you need to decide whether to use the value Massachusetts, or the accepted abbreviation MA as the RDN.

---

<sup>1</sup> It is possible to use more than one attribute value in an entry's RDN, depending on the naming rules of the entry's class. However, multipart RDNs are less user friendly. In the default schema, only the `residentialPerson` and `organizationalPerson` classes permit multipart RDNs, so examples of multipart RDNs should be rare.

## Planning Your Directory Information Tree

### 4.4 Naming Your Entries

Similarly, if your organization is international, you need to decide which language to use for the naming of some entries. For example, if you have an office in Munich, you need to decide whether to use the value Munich or München. The `localityName` attribute can be multivalued, and therefore can have both of the values, but only one of them can be used as the RDN. You should try to choose the value that you think users are most likely to use, recognize, and remember.

Figure 4–8 shows the Abacus DIT plan after names have been chosen for entries.

Figure 4–8 The Abacus DIT with its Entries Named

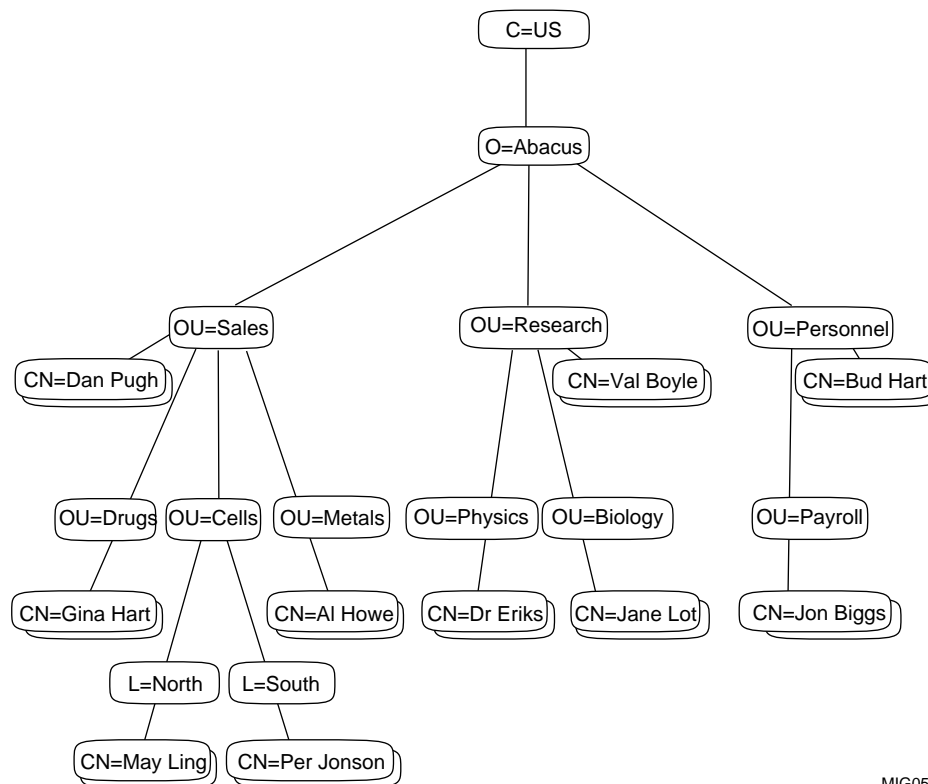

MIG0501

#### 4.4.1 Resolving Naming Clashes

No two entries can have the same distinguished name. Thus, if the Accounts division of the Abacus organization has two people called Alfred Shaw, then there is a naming collision that must be resolved before you create the two Alfreds' entries.

If a naming collision occurs, then there are three possible solutions, as demonstrated by a clash between two people called Alfred Shaw who work in Accounts.

1. You could use some other value for each entry's name.

For example, you could use each man's middle initial to differentiate between their names, giving "Alfred J. Shaw" and "Alfred P. Shaw", for example.

## Planning Your Directory Information Tree

### 4.4 Naming Your Entries

The disadvantages of this solution are that users may not know the middle initials of the two Alfreds, so the names resolve the clash, but fail to make the names any more informative. Users would have to look at other attributes of the two Alfreds' entries to try to determine which one they are actually interested in.

However, this solution is probably the most user friendly of the three.

2. You could use a second naming attribute in the entries' RDNs.

For example, you could call one of the entries#

```
commonName="Alfred Shaw",organizationalUnitName=Settlements
```

and the other

```
commonName="Alfred Shaw",organizationalUnitName=Expenses.
```

Users searching for Alfred Shaw's entry will find both entries, and can decide which one they actually want by noting what organizational unit they are attached to. For example, in a DXIM window, these two entries would be displayed as Alfred Shaw, Settlements and Alfred Shaw, Expenses.

The disadvantages of this solution are that it only applies to classes of entry that permit multipart RDNs, and that the entries' distinguished names become longer and more complicated. Users might have difficulty specifying the distinguished name correctly. End users might not have to use distinguished names often, but if they do, having some names inconsistent with the style of others might be confusing.

3. You could add an extra level of organizational hierarchy to separate the clashing entries from each other.

For example, if one of the Alfreds works in Munich and the other in Madrid, then you could divide the Accounts division into two geographical subdivisions by creating two locality entries beneath the Accounts entry. The entries representing the two Alfreds can then both have the RDN `commonName=Alfred Shaw` because that value is unique relative to their respective localities.

However, the disadvantages of this solution are that it interferes with your hierarchy planning (which you may already have completed and agreed), and might actually make the entries harder to find. It also makes the entries' distinguished names longer and more complicated.

You need to decide which solution to apply to any name clashes that arise in your directory. Compaq recommends that when you design your DIT, you try to divide your organization into small enough divisions to minimize naming clashes, and then for the few clashes that still occur, use the first of the three proposed solutions.

---

#### Note

---

Because most naming attributes are multivalued, entries can still have their most obvious value as well as having a value that is unique for naming purposes. Thus, the two Alfred Shaws entries can both have the value `commonName="Alfred Shaw"`, but they cannot both have that value as their relative distinguished name.

Most end user requests for information will be in the form of directory searches. Directory searches for `commonName="Alfred Shaw"` will succeed regardless of whether that value is the distinguished value. Thus the three methods of resolving naming clashes described in this section do not necessarily decrease the usability of the directory for end users.

## Planning Your Directory Information Tree

### 4.4 Naming Your Entries

Only services that require the specification of an entry's distinguished or relative distinguished name are likely to be made less usable.

The first of the three proposed solutions is probably the most user friendly method of resolving naming clashes, because it does not lengthen an entry's distinguished name as much as the other two methods.

---

### 4.5 Planning Entries to Represent DSAs

Compaq recommends that you represent your Compaq DSAs as directory entries of the `decDSA` class. This is recommended for four main reasons:

- When chaining user requests to another DSA, a Compaq DSA often needs to check the security details of that DSA.

If a DSA is acting for a user who has specified a name and password (authenticated), then chaining might require the DSA to specify its password to the other DSA. However, a Compaq DSA will only specify its password to a DSA that it *trusts*. If there is no trust, a Compaq DSA might return partial results or a continuation reference to the user instead of chaining a request. Chaining of requests for authenticated users can therefore be severely restricted if there is no trust between DSAs.

The `decDSA` entries enable you to establish this trust. A DSA that is represented by a `decDSA` entry with certain attributes is said to be a *trusted DSA*.

- Similarly, when receiving a chained request from another DSA, a Compaq DSA often needs to check the security details of the other DSA.

If the other DSA claims to be acting on behalf of an authenticated user, a Compaq DSA must decide whether it trusts the other DSA. If the Compaq DSA trusts the other DSA, then it assumes that the user has authenticated adequately, and honours that user's access rights. If the Compaq DSA does not trust a DSA that passes such a request, then it rejects the request because it would be a security risk to assume that the user really has authenticated adequately.

- If a Compaq DSA is asked to receive replicated information from another DSA, it always checks the security details of that other DSA.

A Compaq DSA will only receive replicated information from a trusted DSA. An untrusted DSA might try to send replicated information that compromises security. A Compaq DSA rejects such information.

- Compaq DSAs can use the directory to find network addressing information and protocol information about other Compaq DSAs.

For these reasons, it is strongly recommended that you create `decDSA` entries, so that your DSAs cooperate openly with each other, yet provide a service that is adequately protected against certain types of request from unknown or untrusted DSAs and their users.

The `decDSA` class can also be used to represent other vendors' DSAs. If you follow the same guidelines when creating entries to represent other vendors' DSAs, then it becomes possible for your Compaq DSAs to consider other vendors' DSAs to be trusted.

## Planning Your Directory Information Tree

### 4.5 Planning Entries to Represent DSAs

There is an alternative method for implementing security for your Directory Service. You can use NCL commands to configure trust. However, that method has some disadvantages. See Section 7.7 for details of the alternative method of configuring trust, and its disadvantages.

Even if you decide to use the alternative method, you should still plan DSA entries, because they also contain protocol and addressing information. The following sections describe how to plan these `decDSA` entries.

#### 4.5.1 Recommended Position of DSA Entries in Your DIT

For ease of management, Compaq recommends that you represent your DSAs as subordinates of the highest entry in your organization's DIT. For example, the Abacus organization would create its DSA entries as subordinates of the directory entry called `/C=US/O=Abacus`.

The reason for this recommendation is that it simplifies the task of making the entries easily accessible to all DSAs. It is not essential that you name your DSA entries as immediate subordinates of your highest entry, but it greatly simplifies configuration, and improves the performance of security checking during normal DSA operation. This documentation set assumes that you accept this recommendation.

The class of the DSA entries is `decDSA`. The naming attribute of `decDSA` entries is the `commonName` attribute. You can use any policy for choosing common names for DSAs, but Compaq suggests that you incorporate the DSA's node name, so that managers can easily see which DSA is installed on which node.

For example, the Abacus organization might have six DSAs, called:

```
/C=US/O=Abacus/CN="NodeA DSA"  
/C=US/O=Abacus/CN="NodeB DSA"  
/C=US/O=Abacus/CN="NodeC DSA"  
/C=US/O=Abacus/CN="NodeD DSA"  
/C=US/O=Abacus/CN="NodeE DSA"  
/C=US/O=Abacus/CN="NodeF DSA"
```

For the purposes of the examples used in this manual, the naming convention for DSAs is simplified, as follows:

```
/C=US/O=Abacus/CN=DSA1  
/C=US/O=Abacus/CN=DSA2  
/C=US/O=Abacus/CN=DSA3  
/C=US/O=Abacus/CN=DSA4  
/C=US/O=Abacus/CN=DSA5  
/C=US/O=Abacus/CN=DSA6
```

These DSA distinguished names are also known as application entity titles (AE titles). When you configure each DSA using NCL commands, the DSA's distinguished name is specified using the AE Title attribute of the DSA entity.

Figure 4-9 shows the position of DSA entries in the Abacus DIT, as subordinates of the organization entry. The DSA entry called `/C=US/O=Abacus/CN=DSA1` is shown, and the other five DSA entries are created in the same position relative to the organization entry.

## Planning Your Directory Information Tree

### 4.5 Planning Entries to Represent DSAs

Figure 4–9 DSA Entries Beneath the Organization Entry

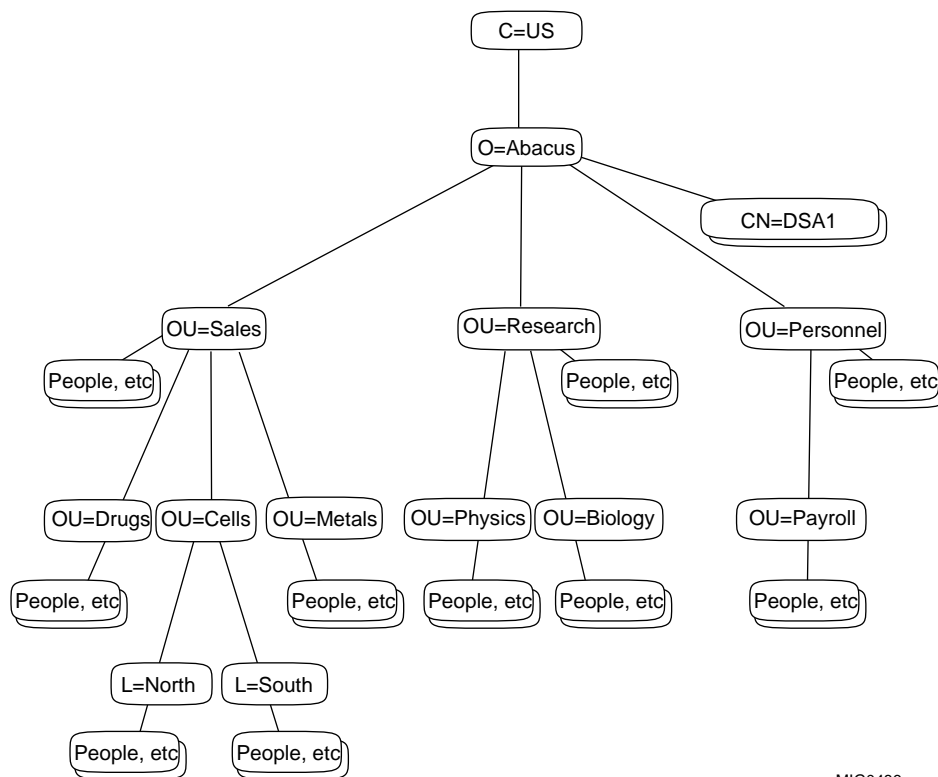

MIG0486

Chapter 5 includes an explanation of how to plan the DXIM commands that will create entries to represent your DSAs, and Chapter 8 explains when to use the commands. As with all directory entries, the ability to create the DSA entries depends on other configuration tasks described in Chapter 8.

If you implement replication as recommended in Chapter 5 and Chapter 8, all DSAs will receive copies of the entries that represent DSAs. This enables all DSAs to interwork securely, because they use the attributes in the DSA entries to verify each other's identities.

---

## Planning DSAs to Hold Your Directory Information Tree

After planning a Directory Information Tree (DIT) for your organization, and positioning it in a global context if possible (Chapter 4), you need to consider how to distribute and replicate it across your network. This requires you to plan DSAs to hold all or part of your DIT.

You have to choose between placing your entire DIT on a single DSA, or dividing your DIT into subtrees and spreading the information across several DSAs. Each subtree of your DIT that you make for distribution (or your entire DIT if you do not divide it into subtrees) is called a *naming context*.

If your entire DIT is quite small, then you might decide to put it on one DSA as one naming context. If you have a large DIT, then for performance reasons you need to divide your DIT into several naming contexts, and distribute them so that no single DSA holds the entire DIT.

Dividing a DIT also means that particular parts of the DIT can be located for the convenience of different directory managers. All modifications of directory information rely on access to the particular DSA where the information was created. You can access DSAs remotely, but depending on your network, remote access can be less efficient than local access. Being able to distribute your directory information therefore also enables you to place particular information close to its manager.

Figure 5–1 illustrates a DIT that has been divided into four naming contexts, and shows that each naming context is a subtree of the DIT as a whole. There is no limit to the size of a naming context, apart from the practical limit imposed by the capacity of your DSAs. (Note that a naming context can be as small as a single entry.) The DSA on which you create a naming context is called the *master DSA* for that naming context and for all entries within it.

## Planning DSAs to Hold Your Directory Information Tree

Figure 5–1 Dividing a DIT into Naming Contexts

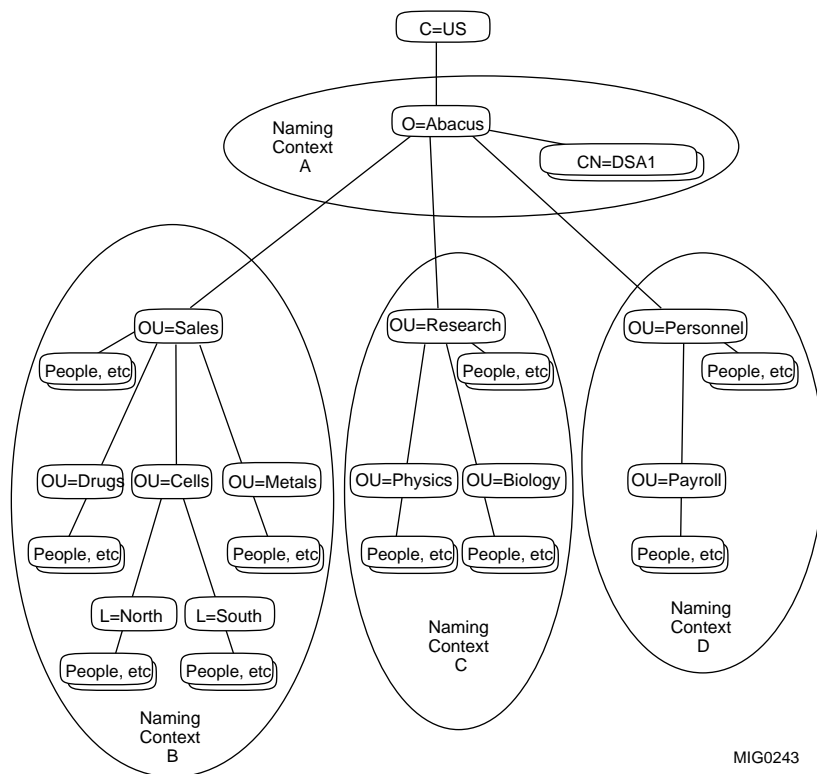

---

### Note

---

The Abacus organization excludes the country entry from its naming contexts. The Abacus organization does not own the country entry, and does not include that entry in its plans for distribution and replication. The division of a DIT into naming contexts starts with the organization entry, that is, the first entry that belongs to the organization, and the first entry that is not part of the organization's global prefix (see Section 4.3).

---

You also need to decide whether to replicate the DIT. However you divide your DIT for distribution, you can create copies of each naming context so that it is not always necessary to contact the master DSA for a given entry. Copies of entries within a replicated naming context are called **shadow copies**, and a DSA that holds shadow copies is called a **shadow DSA** for that naming context. A given DSA can be a shadow DSA for one or more naming contexts at the same time as being the master DSA for one or more other naming contexts. A DSA can hold any number of naming contexts.

This chapter recommends two models of distribution of entries across master DSAs, and then recommends a model of replication that provides good performance for directory users.



## Planning DSAs to Hold Your Directory Information Tree

### 5.1 Dividing Your Directory Information Tree into Naming Contexts

#### 5.1 Dividing Your Directory Information Tree into Naming Contexts

Compaq recommends two ways of dividing your DIT into naming contexts, which are described in the following sections.

##### 5.1.1 Implementing Your DIT as One Naming Context

You can decide not to divide your DIT at all. Your entire DIT can be managed as just one naming context.

This is suitable for organizations whose entire DIT is small enough to be supported by a single DSA. You would implement one DSA to hold the naming context, and a number of other DSAs to hold shadow copies of the entire naming context. If you have systems available that are large enough to hold your entire DIT, then you might consider this option.

If your organization is geographically distributed, then each part of the organization can have a DSA that holds a **shadow copy** of the entire DIT. Users in each part of the organization can contact the most convenient DSA for all requests, giving greater availability of directory information. This means that your organization may have more than one DSA, but the configuration of each DSA is relatively simple.

---

#### Note

---

The unit of replication is the naming context. You should only implement your entire DIT as one naming context if all of your DSAs are to be installed on systems that are large enough to hold the entire DIT.

---

##### 5.1.2 Implementing Your DIT as Several Naming Contexts

You can decide to divide your DIT into several naming contexts so that you can distribute those naming contexts such that no single DSA holds the entire DIT.

The advantages of having several naming contexts and distributing them to several DSAs is that each part of your organization can be given good access to the information that is most useful to it, and the processing cost of responding to user requests for directory information is shared by all of the DSAs. However, this solution requires considerable planning and configuration, because each DSA needs to be configured to know what information it is responsible for, how that information fits into the DIT as a whole, and which DSAs to refer to for other parts of the DIT.

Despite the greater complexity of the configuration tasks required to implement a distributed and replicated DIT, Compaq recommends that you do implement your DIT as several naming contexts. To minimize the complexity of configuring a distributed DIT, Compaq recommends that you divide your DIT as shown in Figure 5-1. The entry representing your organization as a whole is the top of a small naming context: Naming Context A.

This small naming context contains the entries representing your Compaq DSAs and any other resources that need to be represented as immediate subordinates of the organization as a whole. For example, an entry representing the chairman of the organization might be created as a subordinate of the organization entry, and be included in the same naming context.

## Planning DSAs to Hold Your Directory Information Tree

### 5.1 Dividing Your Directory Information Tree into Naming Contexts

Beneath the organization, each immediate subordinate entry that represents a geographical or organizational subdivision of the organization becomes the top of another naming context. Thus, for the Abacus organization, there are three other naming contexts: Naming Context B, Naming Context C, and Naming Context D.

These three other naming contexts are much larger than Naming Context A, and between them comprise most of the Abacus DIT. If any of these naming contexts contains too many entries to be maintained on a single system, then further subdivisions are possible. However, further subdivisions make configuration of the DSAs increasingly complicated, and can reduce the efficiency of the Enterprise Directory. Compaq therefore recommends that you keep the subdivision of the DIT as simple as possible.

#### 5.1.3 Assigning Names to Naming Contexts

Whether you decide to have one or several naming contexts, every naming context has a name.

The name of a naming context is the same as the distinguished name of the entry at its root. For example, in Figure 5-1 the naming contexts have the following names:

- Naming context A is called `/C=US/O=Abacus`
- Naming context B is called `/C=US/O=Abacus/OU=Sales`
- Naming context C is called `/C=US/O=Abacus/OU=Research`
- Naming context D is called `/C=US/O=Abacus/OU=Personnel`

Make a note of the name of each of the naming contexts that form your organization's DIT. When you set up your DSAs, you will need to specify the names of the naming contexts they are to hold.

---

#### Note

---

Particular applications, such as Compaq's MAILbus 400 MTA, might require you to design dedicated subtrees in addition to the organizational DIT described in this book. If so, you can consider each such dedicated subtree to be a naming context. Such a naming context should be "built in" to your main DIT beneath the organization entry.

In the illustrated example, you might have a fifth naming context called `/C=US/O=Abacus/mts="abacus domain"` which is the name of the naming context that contains all routing information used by a messaging application. The RDN `mts="abacus domain"` is the RDN of the highest entry designed according to the requirements of the messaging application, and fits immediately beneath the organization entry.

All information within that naming context is then replicated in exactly the same way as any other naming context. You should consult with the managers of the application to find out whether and where they want their naming context to be replicated.

---

## Planning DSAs to Hold Your Directory Information Tree

### 5.1 Dividing Your Directory Information Tree into Naming Contexts

#### 5.1.4 Distributing Naming Contexts

When you have divided your DIT, choose a master DSA for each naming context. A DSA can hold more than one naming context, but the total size of all naming contexts held on a DSA must not exceed its disk or memory capacity. Each DSA is responsible for responding to all requests to change any information for which it is the master DSA. Therefore, by assigning naming contexts to different master DSAs, you share the processing cost of keeping naming contexts up to date. On the other hand, by making one DSA the master DSA for all naming contexts, you centralize the management of the information. You need to decide where you want the master copy of each naming context to be.

Figure 5-2 shows how the four naming contexts from Figure 5-1 are distributed to four DSAs. This leaves some DSAs without a naming context. Those empty DSAs are to hold shadow copies of naming contexts only (see Section 5.1.5).

When you are distributing naming contexts to DSAs, consider the following factors:

- Try to put each naming context on a DSA that is easily accessible to the managers responsible for the directory entries they contain.

Although the Enterprise Directory supports remote management of directory information, response times are best if the manager can connect directly to the master DSA that holds the relevant entries.

- Try to choose DSAs that are hosted by reliable systems.

All modifications to directory entries require access to the master DSA that holds them. If the master DSA for a given entry is temporarily unavailable, attempts to modify the entry fail.

- The master DSA for your organization's highest naming context (such as Naming Context A) needs to be installed on a node with good network accessibility.

If you follow Compaq's recommendations, then that naming context contains the entries representing your DSAs. Those entries need to be accessible because Compaq's DSAs refer to them and modify them automatically as part of normal operation. The efficiency of your Enterprise Directory depends on the accuracy of the information in your DSA entries.

## Planning DSAs to Hold Your Directory Information Tree

### 5.1 Dividing Your Directory Information Tree into Naming Contexts

Figure 5–2 Distributing Naming Contexts to Their Master DSAs

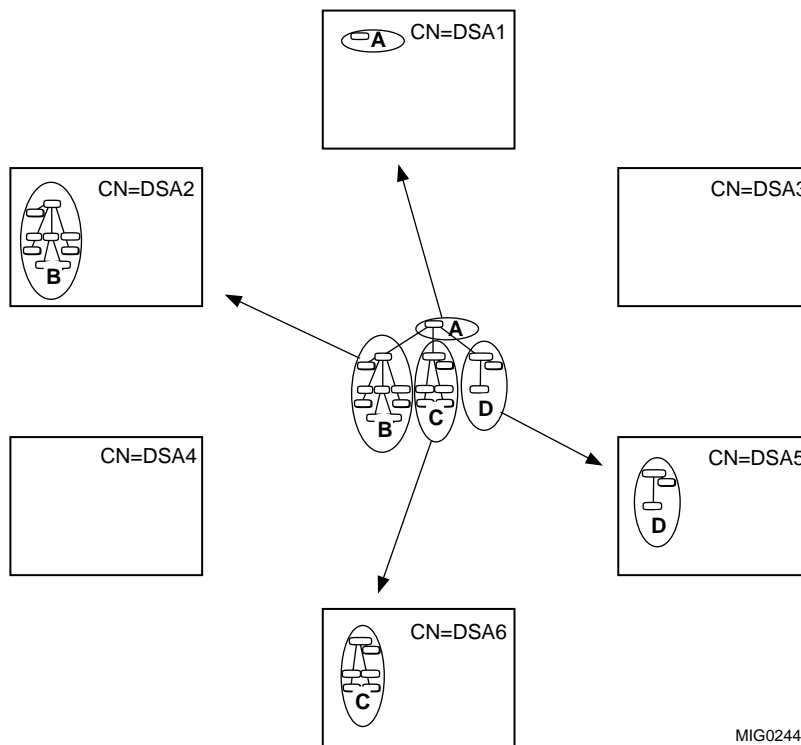

MIG0244

For clarity, in Figure 5–2 and in all examples in this chapter, DSAs are identified by their last RDN, for example `CN=DSA1`. Real DSAs would have distinguished names such as `/C=US/O=Abacus/CN=DSA1`, but such names would make the following examples difficult to read and understand.

#### 5.1.5 Replicating Naming Contexts

Having chosen master DSAs to hold each of your naming contexts (or your single naming context if your DIT is small enough), you can then choose any number of other DSAs to hold shadow copies of one or more of those naming contexts.

The purpose of replication is to place read-only copies of entries as near as possible to the users who require them most frequently, and to provide backup in case the DSA holding the master copy of a naming context becomes temporarily unavailable.

Your network could have many DSAs, most of which hold shadow copies only. You can have any number of shadow copies of a given naming context, although a given DSA only holds one copy of a given naming context.

---

#### Note

Compaq strongly recommends that you give every DSA a shadow copy of the naming context that contains the highest entry in your organization's DIT. This simplifies the configuration requirements of your DSAs (described in Section 5.2), and improves the performance of search requests.

## Planning DSAs to Hold Your Directory Information Tree

### 5.1 Dividing Your Directory Information Tree into Naming Contexts

It also ensures that all of your DSAs have a local copy of the directory entries representing DSAs. This improves the performance of Enterprise Directory security checks, and ensures that each DSA has the information it requires for communicating openly with your other DSAs.

If you decide not to implement replication of **decDSA** entries to all of your DSAs, then you need to implement some additional DSA configuration to enable your DSAs to trust each other. Without either a copy of all **decDSA** entries or some additional management attributes, your users will find that requests that involve more than one DSA might fail. If you do not intend to implement replication as recommended, see Section 7.7 for details of the additional tasks.

---

A shadow copy of a naming context can be copied from the master DSA for that naming context, or from another shadow DSA for it. Thus, you can take shadow copies of entries (called **primary shadowing**), or shadow copies of shadow copies (called **secondary shadowing**).

Secondary shadowing enables you to spread the communication and processing costs of keeping shadow copies up to date. This is because each shadow DSA communicates with its **supplier** to ask for an update of the relevant naming context. Supplying shadow naming contexts requires considerable resources, depending on the size of the naming contexts being supplied. It also temporarily prevents the supplying DSA from answering some user requests, reducing the availability of directory information to end users. If the only supplier is the master DSA, then the master DSA spends a lot of its time communicating with shadow DSAs (**consumers**) simply to help them keep their shadow copies up to date. By allowing shadow DSAs to act as suppliers to further shadow DSAs, the processing cost of keeping shadow copies up to date is shared.

Figure 5-3 illustrates how CN=DSA2 is a consumer of a naming context from CN=DSA1 (the master DSA of the illustrated naming context). However, CN=DSA2 is also a supplier of that naming context to CN=DSA3. The arrow leading from the naming context on CN=DSA1 means that the naming context has a consumer, and likewise for the arrow leading from the naming context on CN=DSA2. Thus, CN=DSA2 relieves CN=DSA1 of the cost of keeping CN=DSA3 up to date. The naming context held by CN=DSA3 is a secondary shadow copy.

**Figure 5-3 Primary and Secondary Shadowing of Naming Contexts**

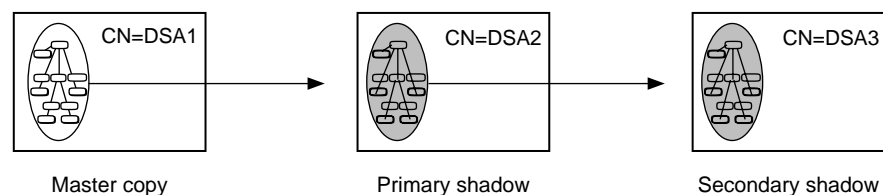

MIG0245

---

#### Note

Compaq's DSAs can only replicate directory information to and from other Compaq DSAs. You can have other vendors' DSAs in your Enterprise

## Planning DSAs to Hold Your Directory Information Tree

### 5.1 Dividing Your Directory Information Tree into Naming Contexts

Directory, but they cannot hold the same naming contexts as your Compaq DSAs.

---

Figure 5-4 shows how the four naming contexts from Figure 5-2 are replicated to other DSAs. The small naming context that is to contain the organization entry and the DSA entries is replicated to all DSAs. Each of the other naming contexts is replicated at least once according to the needs of the user communities near the various DSAs. Some of the DSAs have only shadow naming contexts, and some have a mixture of shadow naming contexts and master naming contexts. Some DSAs have more naming contexts than others, depending on DSA system capacity and the needs of the users local to each DSA. Note also that CN=DSA5 and CN=DSA6 have secondary shadows of the naming context containing the organization entry, supplied by CN=DSA3 rather than CN=DSA1.

Note that there are no empty DSAs. All DSAs now have at least one naming context.

**Figure 5-4 Replicating Naming Contexts to Their Shadow DSAs**

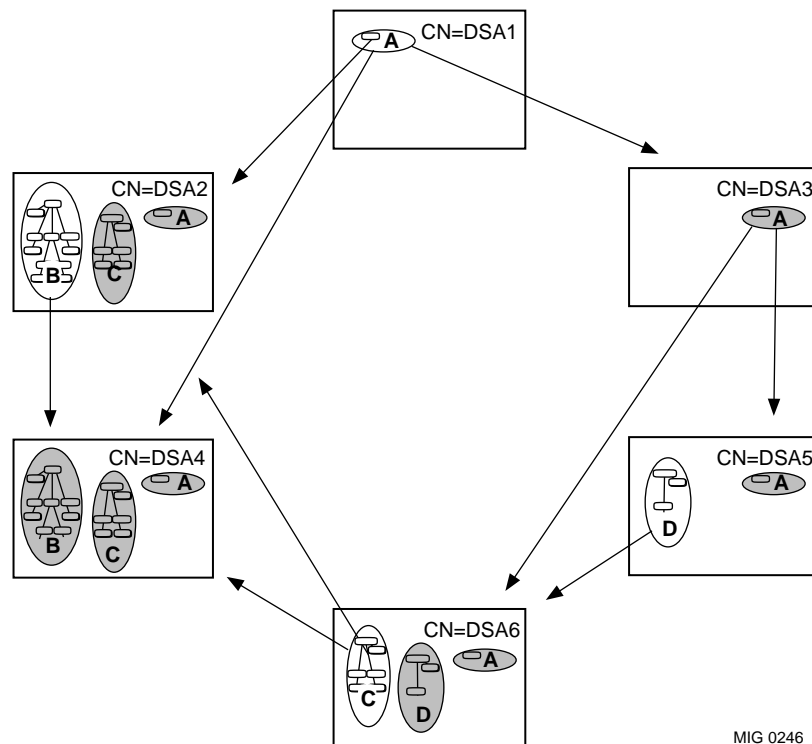

MIG 0246

## 5.2 Planning DSA Configuration Information

To help you configure your DSAs to meet your distribution and replication requirements, Compaq suggests that you create a worksheet for each system that is to host a DSA.

The following sections tell you how to fill out the worksheet. You might also find it useful to have an illustration like Figure 5-4 showing where you want each naming context to be, and with arrows showing the intended replication.

Having planned how to distribute and replicate your DIT across one or more DSAs, you need to plan the configuration details for each of your DSAs so that they fulfill their intended role within your Enterprise Directory.

Every DSA needs to know the following:

- Its own application entity title (AE title), its own presentation addresses, and its own password
- What entries it holds
- Whether it is the master DSA or a shadow DSA for those entries
- If the DSA holds shadow copies, it needs to know which DSA is its supplier, and which DSA is the master DSA for the entries
- Which DSAs, if any, are to consume copies of naming contexts from this DSA
- Where to go for information that it does not hold

These items of information are called knowledge information, and many of them are manually configured. Knowledge information is represented using characteristic attributes of the DSA entity and its subentities. The different requirements are met by the following entities:

- The DSA entity
- The Naming Context entity
- The Superior Reference entity
- The Subordinate Reference entity

For each DSA, you need to plan which of these entities are required, and fill out a worksheet which will help you to configure them.

## Planning DSAs to Hold Your Directory Information Tree

### 5.2 Planning DSA Configuration Information

#### 5.2.1 DSA AE Titles

You need to plan each DSA's application entity title (AE title). This is represented by the AE Title attribute of the DSA entity, and you configure it using NCL commands.

A DSA's AE title is exactly the same as the distinguished name of the directory entry that represents the DSA. For example, a valid DSA AE title is `/C=US/O=Abacus/CN=DSA1`. See Section 4.5 for details of how to plan names for DSA entries.

This version of the Enterprise Directory provides a DSA configuration utility that sets an AE title for a DSA, but it only sets a temporary AE title based on the DSA system name, for example, `/CN="mynode.abacus.com"`. You need to plan an AE title that conforms to your naming policy, and set that value using NCL. (The real benefit of the configuration utility is that it sets a DSA's presentation address.)

Figure 5-5 shows the worksheet for `CN=DSA1` with the AE title filled in.

#### 5.2.2 DSA Passwords

You need to choose a password for each of your DSAs. A DSA uses its password when communicating with other DSAs. For example, a DSA uses its password when it asks a supplier DSA to update its shadow copies, and when chaining a request on behalf of an authenticated user.

---

#### Note

---

DSA passwords are represented in two places: the Password attribute of the DSA entity in NCL, and the `userPassword` attribute of the `decDSA` entry that represents the DSA in the DIT.

When a DSA wants to make a secure connection to another DSA, it quotes the value of the Password characteristic attribute. The target DSA checks this value against the `userPassword` attribute of the `decDSA` entry. It is essential, therefore, that the two representations always match. If you ever change a DSA's password, always change it in both the DSA entity and the `decDSA` entry.

---

Figure 5-5 shows the worksheet for `CN=DSA1` with the password filled in.

#### Figure 5-5 Worksheet for `CN=DSA1` Listing AE Title and Password

<p>Worksheet for <code>CN=DSA1</code> AE Title = <code>/C=US/O=Abacus/CN=DSA1</code> Password = unguessable-textstring</p>
------------------------------------------------------------------------------------------------------------------------------------

MIG0489



## Planning DSAs to Hold Your Directory Information Tree

### 5.2 Planning DSA Configuration Information

#### 5.2.3 DSA Presentation Addresses

This version of the Enterprise Directory provides a DSA configuration utility that sets a DSA's Presentation Address attribute. This saves you from having to plan and set the attribute manually.

Tru64  
UNIX

You need superuser privileges to run the configuration utility. To run the utility, type:

```
# /var/dxd/scripts/dsa_configure
```

◆

OpenVMS

You need SYSPRV and OPER privileges to run the configuration utility. To run the utility, type:

```
$ @SYS$STARTUP:DXD$DSA_CONFIGURE
```

◆

If your privileges are insufficient, the utility displays an error message and exits.

A DSA's presentation address is required not only by the DSA itself, but also as part of the knowledge information of other DSAs. For example, when you implement replication, you will need to specify the presentation address of a consumer DSA in an attribute held by the supplier DSA. You are therefore recommended to add the presentation address to the DSA's worksheet so that you can refer to it easily later. The utility displays the presentation address before exiting.

#### 5.2.4 DSA LDAP Port

The Enterprise Directory listens for LDAP requests on the port where the DSA is enabled. To configure the DSA, set up the LDAP port as follows:

```
ncl> SET DSA LDAP PORT 389
```

The LDAP port number must be non-zero for the DSA to start listening for LDAP requests when the DSA is enabled. The standard TCP/IP port number for LDAP is 389. The DSA configure script in Section 5.2.3 sets the LDAP port to 389.

#### 5.2.5 Naming Context Entities

A naming context is a subtree of the DIT. Each naming context held by a DSA is represented by a Naming Context entity. Without one or more Naming Context entities, a DSA would not know what entries it is expected to hold, and you would be unable to create the relevant part of your DIT.

Each DSA has one Naming Context entity for each naming context that it holds, either as a shadow DSA or as a master DSA. For example, CN=DSA2 in Figure 5-4 needs three Naming Context entities, although it is only the master of one naming context.

Amend your worksheets to list the naming contexts that each DSA is to hold. Section 5.1.3 explains how to determine the names of your naming contexts.

## Planning DSAs to Hold Your Directory Information Tree

### 5.2 Planning DSA Configuration Information

Figure 5–6 Worksheet for CN=DSA2 Listing Naming Contexts

<u>Worksheet for CN=DSA2</u>	
AE Title = "/C=US/O=Abacus/CN=DSA2"	
Password = another-password	
Pres Addr = "'DSA"/"DSA"/"DSA"/NS+49AA001992AAA0000000,CLNS'	
LDAP Port = 389	
Naming Contexts	
(A) /C=US/O=Abacus	(shadow)
(B) /C=US/O=Abacus/OU=Sales	(master)
(C) /C=US/O=Abacus/OU=Research	(shadow)

MIG0274

Figure 5–6 illustrates the worksheet for CN=DSA2 in Figure 5–1. It indicates whether the DSA is the master DSA or a shadow DSA for each of its naming contexts.

The Naming Context entities for the master DSAs of naming contexts have to be created manually. The Naming Context entities for shadow DSAs of naming contexts are created automatically as a result of the replication process.

#### 5.2.5.1 Planning Primary and Secondary Consumer Information

If you are not implementing replication, you do not need to read this section.

Having planned a Naming Context entity, you need to identify any consumers of that naming context (see Section 5.1.5 for a discussion of consumers).

For example, CN=DSA1's Naming Context entity (representing Naming Context A) requires consumer information that identifies each of CN=DSA2, CN=DSA3, and CN=DSA4. Each of those three DSAs is to be a consumer of that naming context directly from CN=DSA1 (see Figure 5–4). They are primary shadows of the naming context.

Note that CN=DSA1 does not need to know about its secondary shadows; CN=DSA5 and CN=DSA6. Instead, CN=DSA5 and CN=DSA6 are consumers from CN=DSA3, so CN=DSA3 needs the consumer information.

When CN=DSA3 gets a copy of the Naming Context entity as a result of replication, you can add consumer access points to it. This is how you implement secondary shadowing.

## Planning DSAs to Hold Your Directory Information Tree

### 5.2 Planning DSA Configuration Information

Fill out your worksheets for each DSA to indicate the AE titles and presentation addresses of the DSAs that are to be consumer of each of its naming contexts (master or shadow).

Figure 5–7 Worksheet for CN=DSA2 Listing Consumers

<u>Worksheet for CN=DSA2</u>	
AE Title	= "/C=US/O=Abacus/CN=DSA2"
Password	= another-password
Pres Addr	= "DSA"/"DSA"/"DSA"/NS+49AA001992AAA0000000,CLNS'
LDAP Port	= 389
Naming Contexts	
(A)	/C=US/O=Abacus (shadow)
(B)	/C=US/O=Abacus/OU=Sales (master) consumer AE Title = "/C=US/O=Abacus/CN=DSA4" Pres Addr = "DSA"/"DSA"/"DSA"/NS+49aa001992aa90000000,CLNS'
(C)	/C=US/O=Abacus/OU=Research (shadow)

MIG0275

Figure 5–7 illustrates the worksheet for CN=DSA2 after information about one consumer DSA has been added.

In Figure 5–4 there is an arrow leading from each naming context to each of its shadows. Each arrow means that its naming context has a consumer, so you need as many items of consumer information for a given naming context as there are arrows. For CN=DSA2, only one of its naming contexts is consumed by another DSA (CN=DSA4 consumes a copy of naming context B), so it requires one item of consumer information for that naming context only.

Cross-check your DSA worksheets to ensure that each shadow DSA is listed as a consumer by each of its suppliers. For example, CN=DSA2 is a consumer of two naming contexts, so you would check the worksheets for CN=DSA1 and CN=DSA6 to ensure that they each list CN=DSA2 as a consumer of the relevant naming context.

The worksheets could also specify the details of each DSA's suppliers. However, supplier details are automatically created on a consumer DSA during replication, so adding them to the worksheets is not essential. However, you do use the presentation address of a supplier when you replicate for the first time, so it is useful to make a note of them. Figure 5–8 shows the worksheet for CN=DSA2 with the supplier details filled in for reference purposes.

## Planning DSAs to Hold Your Directory Information Tree

### 5.2 Planning DSA Configuration Information

Figure 5–8 Worksheet for CN=DSA2 Listing Suppliers

```
Worksheet for CN=DSA2

AE Title = "/C=US/O=Abacus/CN=DSA2"
Password = another-password
Pres Addr = "DSA"/"DSA"/"DSA"/NS+49AA001992AAA0000000,CLNS'
LDAP Port = 389

Naming Contexts

(A) /C=US/O=Abacus (shadow)
    supplier AE Title = "/C=US/O=Abacus/CN=DSA1"
           Pres Addr = "DSA"/"DSA"/"DSA"/NS+49004005002B0AEBDB21,CLNS'

(B) /C=US/O=Abacus/OU=Sales (master)
    consumer AE Title = "/C=US/O=Abacus/CN=DSA4"
           Pres Addr = "DSA"/"DSA"/"DSA"/NS+49AA001992AA90000000,CLNS'

(C) /C=US/O=Abacus/OU=Research (shadow)
    supplier AE Title = "/C=US/O=Abacus/CN=DSA6"
           Pres Addr = "DSA"/"DSA"/"DSA"/NS+49aa0019922aa22000000,CLNS'
```

MIG0491

#### 5.2.6 Subordinate Reference Entities

If you are implementing your entire DIT as one naming context, you do not need to read this section.

Subordinate references serve two purposes:

- They provide DSAs with the information they need to locate naming contexts that they do not hold.
- They mark the boundaries between naming contexts, such that a DSA does not claim ownership of entries that actually belong in a naming context held by another DSA.

Your planning task is to identify which DSAs require the *manual* creation of Subordinate Reference entities. Subordinate references that mark the lower boundary of a naming context are always replicated with that naming context. Therefore, you only need to create the subordinate references on the master DSA for that naming context. Section 5.2.6.1 explains how to identify which DSAs need the manual creation of Subordinate Reference entities.

##### 5.2.6.1 Identifying Which DSAs Require Manually Created Subordinate References

Firstly, only master DSAs require the manual creation of Subordinate Reference entities. Any DSA that holds only shadow information requires no manual intervention.

For each master DSA, you need to consider each of its master naming contexts. Each master naming context that is *immediately superior* to another naming context requires a Subordinate Reference entity to that subordinate naming context. A given naming context may require multiple Subordinate Reference entities because it is immediately superior to several naming contexts.

## Planning DSAs to Hold Your Directory Information Tree

### 5.2 Planning DSA Configuration Information

This requirement applies regardless of whether the immediately subordinate naming contexts are held locally or remotely.

If you have followed Compaq's advice for dividing your DIT into naming contexts, you have only one naming context that has subordinate naming contexts. The master DSA for that naming context requires you to create Subordinate Reference entities to mark the boundaries between the superior naming context and each of the subordinate naming contexts.

To return to the example DIT illustrated in Figure 5-1, Naming Contexts B, C, and D are all immediately subordinate to Naming Context A. Therefore, CN=DSA1, the master DSA for Naming Context A (see Figure 5-4), needs three Subordinate Reference entities that identify where naming contexts B, C, and D are held.

If you divided your DIT in a more complicated way, then you must consider the requirements of each master naming context that is superior to further naming contexts. For example, Figure 5-9 illustrates a DIT that is divided into many layers of naming contexts. In this example, there are several naming contexts that have subordinate naming contexts, and therefore need subordinate references.

The disadvantage of this way of dividing your DIT is that you increase the amount of configuration that you need to do to ensure that all DSAs have a complete set of knowledge information. If any DSA has incomplete knowledge, it is likely that user requests for information will not be satisfied efficiently. It is also possible that DSAs will not realise that some naming contexts exist, and that some entries will be created on the wrong DSA as part of the wrong naming context. To reduce the chance of having incomplete knowledge and to optimize performance, Compaq recommends the simpler division of your DIT illustrated in Figure 5-1.

**Figure 5-9 A Multi-Layered Division of a DIT**

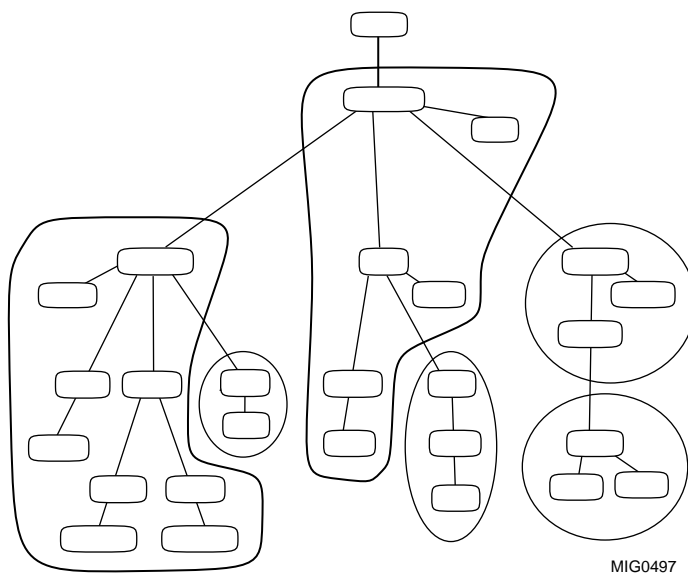

## Planning DSAs to Hold Your Directory Information Tree

### 5.2 Planning DSA Configuration Information

Amend your worksheets to reflect your Subordinate Reference requirements. For each Subordinate Reference entity, make a list of the AE titles and the presentation addresses of the DSAs that hold a master or shadow copy of the naming context<sup>1</sup> to which the subordinate reference refers. Indicate whether each DSA referred to is the master DSA or a shadow DSA for the relevant naming context.

Figure 5–10 illustrates the worksheet for CN=DSA1 after this information has been added.

**Figure 5–10 Worksheet for CN=DSA1 Listing Subordinate Naming Contexts**

Worksheet for CN=DSA1	
AE Title	= "/C=US/O=Abacus/CN=DSA1"
Password	= unguessable-textstring
Pres Addr	= "DSA"/"DSA"/"DSA"/NS+49004005002B0AEBDB21,CLNS'
LDAP Port	= 389
Naming Contexts	
(A) /c=us/o=abacus	(master)
consumer	AE Title = "/C=US/O=Abacus/CN=DSA2" Pres Addr = "DSA"/"DSA"/"DSA"/NS+49aa001992aaa0000000,CLNS'
consumer	AE Title = "/C=US/O=Abacus/CN=DSA3" Pres Addr = "DSA"/"DSA"/"DSA"/NS+49aa001992aa20000000,CLNS'
consumer	AE Title = "/C=US/O=Abacus/CN=DSA4" Pres Addr = "DSA"/"DSA"/"DSA"/NS+49aa001992aa90000000,CLNS'
Subordinate References	
(B) /C=US/O=Abacus/OU=Sales	
master	AE Title = "/C=US/O=Abacus/CN=DSA2" Pres Addr = "DSA"/"DSA"/"DSA"/NS+49aa001992aaa0000000,CLNS'
copy	AE Title = "/C=US/O=Abacus/CN=DSA4" Pres Addr = "DSA"/"DSA"/"DSA"/NS+49aa001992aa90000000,CLNS'
(C) /C=US/O=Abacus/OU=Research	
master	AE Title = "/C=US/O=Abacus/CN=DSA6" Pres Addr = "DSA"/"DSA"/"DSA"/NS+49aa001992aa22000000,CLNS'
copy	AE Title = "/C=US/O=Abacus/CN=DSA2" Pres Addr = "DSA"/"DSA"/"DSA"/NS+49aa001992aaa0000000,CLNS'
copy	AE Title = "/C=US/O=Abacus/CN=DSA4" Pres Addr = "DSA"/"DSA"/"DSA"/NS+49aa001992aa90000000,CLNS'
(D) /C=US/O=Abacus/OU=Personnel	
master	AE Title = "/C=US/O=Abacus/CN=DSA5" Pres Addr = "DSA"/"DSA"/"DSA"/NS+49aa001992aa30000000,CLNS'
copy	AE Title = "/C=US/O=Abacus/CN=DSA6" Pres Addr = "DSA"/"DSA"/"DSA"/NS+49aa001992aa22000000,CLNS'

MIG0276

#### 5.2.7 Superior Reference Entities

You only need to plan superior references if either or both of the following are true:

- Some DSAs do not have a copy of your highest naming context.

<sup>1</sup> Each Subordinate Reference entity can refer to the master DSA and/or to any shadow DSAs of a subordinate naming context. You are advised to provide each Subordinate Reference entity with a complete set of references to all available copies, as this increases the chances of user requests succeeding.

## Planning DSAs to Hold Your Directory Information Tree

### 5.2 Planning DSA Configuration Information

Any such DSA needs a superior reference to a DSA that does hold that context. For example, all DSAs in Figure 5-4 could have a superior reference to **CN=DSA1**, the master DSA for naming context A. However, since they all have a copy of naming context A, this is optional.

- Your DIT is connected to a global Enterprise Directory.

In this case, DSAs that hold a copy of your highest naming context require a reference to one external DSA that holds an even higher naming context.

DSAs that do not hold a copy of your highest naming context need a superior reference to one that does.

If you follow Compaq's recommendation for dividing and replicating your DIT, none of your DSAs will need one, unless your Enterprise Directory is connected to a global service.

A superior reference ensures that if a DSA receives a request for which none of its other knowledge information is helpful, it can pass the request to a DSA that holds hierarchically superior information. A DSA with high level naming contexts often knows about parts of the DIT that a lower DSA does not know about.

A superior reference is represented by a Superior Reference entity, and contains the AE title and presentation address of a superior DSA.

If any of your DSAs require a superior reference, add the AE title and presentation address of a superior DSA to the relevant worksheets. In the example, none of the Abacus DSAs require a superior reference.

Note that Superior Reference entities are not replicated. You need to create a Superior Reference manually on each DSA that requires one.

#### 5.2.8 Using the Worksheets

When you have filled out the DSA worksheets, you have the information required to configure your DSAs after installation. See Chapter 8 for details of how to use the worksheets to configure DSAs.

#### 5.2.9 Attributes of DSA Entries

Chapter 4 explained that you need to represent your DSAs using directory entries, and explained how to plan names for those entries. This section explains how to plan the DXIM commands that you will use to create the entries that represent your DSAs. You will use these DXIM commands as part of your configuration, as described in Chapter 8.

When you create an entry to represent one of your Compaq DSAs, you must specify values for each of the following attributes:

```
objectClass  
commonName (specified as part of the entry's distinguished name)  
presentationAddress  
userPassword  
trustedDSAName
```

During normal operation, a Compaq DSA automatically modifies its own entry to add more attributes. Indeed, it is possible that a DSA will create its entry before you do. In that case, your task is to ensure that all of the above attributes are present, and to modify the entry to add any that are not present.

The following subsections discuss these attributes.

## Planning DSAs to Hold Your Directory Information Tree

### 5.2 Planning DSA Configuration Information

#### Object Class

Use the `decDSA` class. This is a subclass of `dSA` and `applicationEntity`.

#### Common Name

A DSA's common name is planned as described in Section 4.5.1, for example, `CN=DSA1`.

When you create a DSA entry, the common name is actually specified as part of the entry's distinguished name, for example, `/C=US/O=Abacus/CN=DSA1`.

#### Presentation Address

The value of the `presentationAddress` attribute is planned in Section 5.2.3.

#### User Password

The `userPassword` attribute must match the Password characteristic attribute of the DSA entity (see Section 5.2.1). The password is case sensitive.

If the values do not match, other DSAs will be unable to verify the DSA's identity. This restricts the DSA's ability to interwork with other DSAs.

#### Trusted DSA Name

The `trustedDSAName` attribute must specify the distinguished name of the `decDSA` entry, for example, `/C=US/O=Abacus/CN=DSA1`.

#### 5.2.9.1 Planning the DXIM Command to Create DSA Entries

Plan the DXIM command line that you will use to create each DSA entry. For example, the following example would create an entry to represent one of the Abacus DSAs:

```
dxim> create /C=US/O=Abacus/CommonName=DSA1 -
_dxim> attributes objectClass=(applicationEntity,dSA,decDSA), -
_dxim> trustedDSAName="/C=US/O=Abacus/CN=DSA1", -
_dxim> userPassword=unguessable-textstring, -
_dxim> paddr="'DSA"/"DSA"/"DSA"/NS+49004005002B0AEBDB21,CLNS'
```

This command will create the DSA entry to represent `CN=DSA1`. The name of the entry is the one planned in Section 4.5.1, and is identical to the AE Title attribute of the DSA entity. The values of the various attributes match the values planned in this chapter. To reduce line length, the abbreviated keyword `paddr` is used for the `presentationAddress` attribute.

Plan a similar DXIM command line for each of your Compaq DSAs. These commands will be used when you configure your Enterprise Directory, as described in Chapter 8.

There are alternative methods of configuring DSAs to be able to recognize each other, using characteristic attributes and subentities of the DSA entity. That alternative method has several management disadvantages, but if you want to consider it, see Section 7.7.



---

## Customizing the Schema

Chapter 4 explained how to plan a DIT and choose classes and names for your entries. If you were able to choose a standard class for each type of object that you want to represent, and the default rules for those classes meet your needs, then you do not need to customize the schema and do not need to read this chapter.

This chapter explains how to customize the schema so that it is possible to store information that is not permitted by the default schema definitions. For example, this chapter describes how to:

- Define new attribute types
- Define auxiliary classes that enable you to increase the range of attributes that you can store in an entry
- Define structural classes that enable you to represent objects for which no standard class is suitable

Defining a structural class also requires the definition of the following:

- Rules for naming entries of the new class (a name form)
- Rules for where such entries may be created in the hierarchy (structure rules)

If you make customizations, you can also define how the new information is to be displayed in DXIM. For example, for new attributes you can specify user friendly descriptive names, and for classes you can specify the order in which attributes are displayed. Such rules for displaying directory information can also be defined in the schema<sup>1</sup>.

New attributes and auxiliary classes can be defined at any time either before or after you create directory entries. You can make an entry a member of an auxiliary class at any time, which means you do not need to do it immediately. However, if you need to define a structural class, you must do so before you attempt to create the entries of that class. You cannot change an entry's structural class once an entry has been created.

---

<sup>1</sup> Rules for displaying information in the Lookup Client are defined in its defaults file. The Lookup Client does not refer to the schema. See Section 9.7 for details of customizing the Lookup Client defaults file.

## Customizing the Schema

### 6.1 Schema Text Files

#### 6.1 Schema Text Files

Compaq's schema is provided as a set of text files<sup>2</sup> with the file extension `.sc`.

Tru64  
UNIX

The schema text files are installed in `/var/dxd`, and are called:

`dec.sc`  
`dit.sc`  
`dua.sc`  
`dxd_schema.sc`  
`mts.sc`  
`cosine.sc`  
`quipu.sc`  
`x400.sc`  
`x500.sc`  
`ids.sc`  
`entrust.sc`

◆

OpenVMS

The schema files are installed in `DXD$DIRECTORY`, and called:

`DEC.SC`  
`DIT.SC`  
`DUA.SC`  
`DXD$SCHEMA.SC`  
`COSINE.SC`  
`QUIPU.SC`  
`MTS.SC`  
`X400.SC`  
`X500.SC`  
`IDS.SC`  
`ENTRUST.SC`

◆

To customize the schema, create a file with the file extension `.sc` in the relevant directory, for example, `customer.sc`. Use this file to contain all of your definitions. Edit `dxd_schema.sc` or `DXD$SCHEMA.SC`, as appropriate, to make sure that your file is included whenever you run the schema compiler.

If you need to edit any of the schema files provided with the Directory Service, always make a copy of the file first, so that you can undo any mistakes easily. Ideally, you should experiment with the schema on a test system rather than on a production system.

The DSA and DXIM read the compiled schema during startup, so if you change the schema you need to stop and restart them.

---

<sup>2</sup> `MTS.SC` and `IDS.SC` contain definitions for other Compaq applications, and must not be amended. Both `COSINE.SC` and `QUIPU.SC` contain definitions for `COSINE` and `QUIPU` directory services. The `COSINE` definitions were defined in RFC1274 and have definitions that are used by many directories. The `ENTRUST.SC` schema provides directory definitions for the Entrust V5.0 product. `DEC.SC` contains definitions required by the DSA, and must not be amended. The inclusion of these definitions enables DXIM to handle information from those services should you make a connection. Displays of such information should be user-friendly. However, Compaq's DSA does not support all of the syntaxes required by these definitions, so entries based on those definitions cannot necessarily be held by the DSA. Appendix A documents the syntaxes supported by Compaq's DSA.

#### Notes About Compaq's Schema Files

This section contains useful notes about Compaq's schema files.

Every time you reinstall the Enterprise Directory on OpenVMS systems, or deinstall it on Tru64 UNIX systems, the procedure saves any schema files it finds on the system. Every installation leads to a default set of schema files being created. If you customize your schema, then after any reinstallation, you need to retrieve your schema files and copy them over the newly installed defaults.

Tru64  
UNIX

During deinstallation of the Enterprise Directory, schema files are moved to `/var/dxd/savn` where `n` is a unique number. After the next installation, you can retrieve any customizations from that subdirectory.

◆

OpenVMS

The schema files are saved in a subdirectory of `DXD$DIRECTORY`, called `DXD$DIRECTORY:[DXD$SERVER.SAVn]`, where `n` is a unique number. After reinstalling the Enterprise Directory, you can retrieve your schema files from that subdirectory, and start the DSA.

If you are upgrading from a previous version of the Enterprise Directory software, then you need to combine your customizations with the newly installed schema source files. You must not use old versions of the default schema files with the new Enterprise Directory. The newly installed schema files contain important amendments. See *Read Before Installing* for further details.

◆

If you want to make notes in your schema file, you can use two hyphens (-) as comment characters. For example:

```
-- this line is ignored during schema compilation
```

Some of the default schema definitions are required for the operation of the Enterprise Directory. You must therefore edit the default schema files with great care, and keep records of all changes you make. Specifically, many of the definitions in the `DEC.SC` file are required by the Enterprise Directory, and must not be changed. Also, the definitions in `MTS.SC` are required by Compaq's MAILbus 400 MTA, and must not be changed. If you ever change the schema in ways that prevent the Enterprise Directory or the MAILbus 400 MTA from working, you must undo the relevant changes, or reinstall the Enterprise Directory and start your customizations again.

All schema definitions are case sensitive. Whenever you edit the text files, make sure that all references from one definition to another are consistent in case. For example, if you define an attribute type called `employeeNumber`, then all references to that attribute type must use that same combination of uppercase and lowercase letters.

The encoding of Compaq's schema files is not portable to another vendor's DSA or directory application. If you want another vendor's DSA to support definitions from Compaq's schema files, refer to the other vendor's documentation for details of how their product supports schema customization.

## Customizing the Schema

### 6.1 Schema Text Files

#### Conventions Used to Document Schema Definitions

This chapter contains several statements of the syntax that you use to specify new schema definitions. This section explains the conventions used.

Schema definitions are case sensitive. Schema keywords are all in uppercase letters. For example, the following is an example of an attribute definition:

```
commonName ATTRIBUTE
    WITH ATTRIBUTE-SYNTAX stringSyntax (SIZE(1..64))
    EQUALITY MATCHING RULE caseIgnoreStringMatch
    ORDERING MATCHING RULE caseIgnoreStringMatch
    SUBSTRING MATCHING RULE caseIgnoreSubstringMatch
    APPROXIMATE MATCHING RULE initialWordApproximateMatch
    STORE NORMALIZED
    ::= {attributeType 3}
```

The sequence of the arguments of a definition is significant. For example, if you rearrange the order of the lines of a definition, the schema compiler returns errors.

If you use lowercase letters for keywords, such as `ATTRIBUTE`, the schema fails to compile. Other parts of the definitions are also case sensitive, such that all references to the attribute `commonName` must use that combination of lowercase and uppercase characters. The same applies to the names of syntaxes, classes, matching rules, and so on.

To clarify which parts of a definition are optional, this chapter uses square brackets [ ] to enclose optional parts. For example, the following is the syntax of an attribute definition:

```
attributeName ATTRIBUTE
    WITH ATTRIBUTE-SYNTAX syntaxName [constraint]
    [EQUALITY MATCHING RULE matchingRuleName]
    [ORDERING MATCHING RULE matchingRuleName]
    [SUBSTRING MATCHING RULE matchingRuleName]
    [APPROXIMATE MATCHING RULE matchingRuleName]
    [SINGLE VALUED]
    STORE NORMALIZED | STORE ORIGINAL
    ::= {attributeType n}
```

In this case, the `constraint` argument is optional, and so are each of the lines that declare a matching rule, and the line that states whether an attribute is single-valued.

To clarify parts of a syntax that are a choice, this chapter uses the `|` character. For example, in the above syntax definition, there is a choice of `STORE NORMALIZED` and `STORE ORIGINAL`. You must specify one of the listed choices.

The letter `n` specified on its own indicates that an integer is required.

Variable parts of the syntax are shown in mixed case, and are explained in the text that accompanies the example. For example, `attributeName` is a variable, and the accompanying text explains that this is where you specify the name of the attribute for which this is the definition.

## 6.2 Compiling the Schema

The schema compiler reads the files included by `dxd_schema.sc` or `DXD$$SCHEMA.SC`, and creates a single data file called `dxd_schema.dat` or `DXD$$SCHEMA.DAT`. The schema file is required by the DSA and the DXIM utility.

During installation, a compiled version of the default schema data file is installed. The default schema contains standard object classes and attributes defined by international standards bodies and Enterprise Directory providers. If the default schema meets your requirements, you never need to use the schema compiler.

If you customize the schema, for example to define a new class, you need to recompile the schema, as follows:

Tru64  
UNIX

Before compiling the schema, make a copy of the existing `dxd_schema.dat` file. This will enable you to return to that version of the schema in the event that your customizations are incompatible with the entries already held in the DSA.

To compile the schema, type the following commands:

```
# cd /var/dxd
# /usr/sbin/dxd_sc
```

The compiled schema is created in `/var/dxd`.

◆

OpenVMS

To compile the schema, type:

```
$ SET DEFAULT DXD$DIRECTORY
$ RUN SYS$SYSTEM:DXD$SCHEMA_COMPILER.EXE
```

The compiled schema is created in the `DXD$DIRECTORY` directory.

◆

If the schema compiler finds any errors in the schema text files, such as duplicate definitions or references to non-existent definitions, the compilation fails, and an error is displayed. Edit the files to fix any errors, and recompile.

After compiling the schema successfully, stop and restart the DSA as follows:

Tru64  
UNIX

```
# ncl
ncl> DISABLE DSA
ncl> DELETE DSA TO SNAPSHOT
ncl> CREATE DSA FROM SNAPSHOT
ncl> ENABLE DSA
```

The deletion and creation take longer than usual because the snapshot option is specified. This version of the DSA on Tru64 UNIX systems uses memory image files by default. Snapshot files are only required for a few tasks such as the loading of a newly compiled schema file. See Section 8.3 for further details of the memory image file.

## Customizing the Schema

### 6.2 Compiling the Schema

When the DSA has been recreated and enabled successfully with the new schema, you can delete the snapshot file from the DSA system, as follows:

```
# rm DSA-information-tree.snapshot*
```

The DSA does not need this file any longer, so you can save disk space by deleting it. Do not delete any of the other database files.

◆

OpenVMS

```
$ RUN SYS$SYSTEM:NCL
NCL> DISABLE DSA
NCL> DELETE DSA
NCL> CREATE DSA
NCL> ENABLE DSA
```

◆

If the new schema is incompatible with the entries already in the DSA, the CREATE DSA directive fails, and issues a message identifying the definition that is missing from the schema. In this case, check your customizations carefully, correct any problems, recompile the schema, and repeat the sequence of commands as shown above for the relevant operating system.

If you want to run the DSA while you review and fix your customizations, copy the old schema data file back into position, and continue to use that. Remember to use the FROM SNAPSHOT argument to the CREATE DSA command on Tru64 UNIX systems in this case. When reviewing your customizations, remember that the customized schema must continue to support all existing entries, as well as supporting the new classes and attributes that you define. If you really want to retire some definitions that are in use in the database, you need to delete any entries that are based on those definitions.

When you have customized the schema and restarted the DSA successfully, you should also stop and restart any DXIM processes so that they also read the new schema. If DXIM uses the same schema as your DSAs, then they can display information consistently, and allow you to create and modify entries based on the new definitions.

---

#### Note

---

Compaq recommends that all Enterprise Directory nodes use the same schema, especially if you intend to replicate directory information between DSAs. Therefore, if you customize the schema, edit the schema text files on one node, verify that they compile without error and are compatible with the existing DIT, and then copy those text files to every DSA node and to every DXIM node. Compile the schema text files on each node before restarting the DSA and DXIM on that node.

Note that you cannot copy the compiled schema data file across nodes. You must copy the text files, and recompile on each node. The text files are platform independent.

---

## 6.3 Assigning Object Identifiers to New Definitions

Many of the definitions you can make in the schema require a unique object identifier. The definitions that require object identifiers are:

- Attribute definitions
- Class definitions
- Name Forms

Structure rule definitions have integer identifiers, but these are not required to be globally unique. Structure rule identifiers need only be unique within your schema. Other definitions have no identifier, or are not customer definable.

This section describes how to define an object identifier that uniquely identifies your organization's schema customizations, and then a set of object identifiers for your organization's attributes, classes, and name forms. If you do not ensure that your organization uses unique object identifiers for its schema customizations, there is a possibility that your definitions will clash with those of other organizations, causing interworking problems.

If there is a Enterprise Directory naming authority already established for your country or region, then you can refer to them and ask them to assign a unique object identifier to your organization's schema customizations. If no such naming authority exists, then Compaq's schema files include an object identifier that you can use as the basis for unique object identifiers.

The schema file DEC.SC contains the following definitions:

```
customerSQMfacility OBJECT-IDENTIFIER ::= {dec-osi-directory 10}
customerIntTelNumber OBJECT-IDENTIFIER ::= {dec-osi-directory 11}
```

You use one of these definitions as follows:

- If your organization has a Software Quality Management facility code, assigned by Compaq, then you can use that code in conjunction with the `customerSQMfacility` definition.

For example, the Abacus organization has the SQM facility code 97887. The Abacus directory manager could therefore create the following definition in the schema file CUSTOMER.SC:

```
abacusId          OBJECT-IDENTIFIER ::= {customerSQMfacility 97887}
```

- You can use the international telephone number of your organization in conjunction with the `customerIntTelNumber` definition.

For example, the Abacus organization has the international telephone number 1 123 5554444. This includes all of the country and regional codes. The Abacus directory manager could therefore create the following definition in the schema file CUSTOMER.SC:

```
abacusId          OBJECT-IDENTIFIER ::= {customerIntTelNumber 11235554444}
```

You need to define either one of the above definitions. In either case, you can then use the unique identifier of your organization to make three further definitions, as follows:

```
abacusAttributeType OBJECT-IDENTIFIER ::= {abacusId 1}
abacusObjectClass   OBJECT-IDENTIFIER ::= {abacusId 2}
abacusNameForm      OBJECT-IDENTIFIER ::= {abacusId 3}
```

## Customizing the Schema

### 6.3 Assigning Object Identifiers to New Definitions

Having defined these three object identifiers, you can then use their descriptive names in your schema definitions of attributes, classes, and name forms. For example:

```
employeeNumber ATTRIBUTE
    WITH ATTRIBUTE-SYNTAX numericSyntax
        EQUALITY MATCHING RULE numericStringMatch
        SUBSTRING MATCHING RULE numericSubstringMatch
    STORE NORMALIZED
    ::= {abacusAttributeType 1}

abacusEmployee OBJECT-CLASS SUBCLASS OF top AUXILIARY
    MUST CONTAIN {
        employeeNumber
    }
    MAY CONTAIN {
        birthDate,
        hireDate,
        tmServer
    }
    ::= {abacusObjectClass 1}

dogNameForm NAME-FORM
    NAMES dog
    WITH ATTRIBUTES commonName
    ::= {abacusNameForm 100}
```

These object identifiers are guaranteed to be unique to your organization's schema, and therefore will never clash with schema definitions of other organization's whose Enterprise Directory you might connect to.

### 6.4 Planning to Customize the Schema

Having chosen a standard structural class, such as `organizationalPerson` to represent an object, and perhaps created entries using that class, you might decide that the class does not enable you to represent all of the information that you would like. Indeed, you might find that there is no standard structural class suitable for one of your types of object.

The following sections use case studies to illustrate how to plan extra information requirements, and then how to implement those plans.

Section 6.5 uses the example of employees to illustrate how to plan extra information for `organizationalPerson` entries.

Section 6.7 explains how to plan a completely new structural class to represent an object for which there is no standard structural class.

Those two sections also describe any customizations you need to make to the schema files to provide user friendly displays of your new definitions in the DXIM utility.

In addition, Section 6.9 describes how to customize or define user friendly search filters for use in the DXIM Find window. The purpose of the filter definitions is to reduce the amount of information that end users need to understand when they are searching the directory. If you do not intend to use the DXIM windows utility, then you do not need to read Section 6.9.



## 6.5 Planning an Auxiliary Class

The Abacus organization wants to create X.500 entries to represent each of its employees. It has a list of information that it wants to represent in those entries, and has chosen the `organizationalPerson` class as a starting point.

The `organizationalPerson` class provides many useful attributes, but Abacus wants to represent a range of other information which is not provided for by that class. The list of other information that Abacus wants to represent is:

- The unique employee number by which Abacus identifies each of its employees
- The date that an employee was originally hired by Abacus
- The date of birth of an employee
- A name of the time management server that an employee uses

The personnel department stated a requirement for the first few attributes so that they could monitor employment trends; the time management application developers stated the requirement for the time management server name.

---

### Note

---

The list of requirements is used to illustrate the planning process only. Compaq does not suggest that these particular attributes are useful or appropriate for your organization.

---

None of the attributes provided by the default schema meet these particular requirements. The Abacus planning team therefore has to plan how to extend the default schema so that the required information can be stored, and so that the newly defined attributes are permitted within entries of the `organizationalPerson` structural class.

To meet this requirement, the Abacus team define an auxiliary class called `abacusEmployee`. The auxiliary class can be used with all entries of the `organizationalPerson` structural class. The `abacusEmployee` class is to have four attributes, all of which are defined by Abacus.

For each of the new attributes, the planning team make a number of decisions, as follows:

- They define an `employeeNumber` attribute.  
They decide that the `employeeNumber` attribute is a single-valued attribute with an integer syntax. Each employee has only one employee number, so it would be incorrect to permit multiple values. They also decide that the attribute is mandatory so that all employee entries must include it.
- They define a `birthDate` attribute.  
The `birthDate` attribute is to be single-valued, with a numeric string syntax, such as "12 12 1962". The attribute is optional.  
The team agree that every date should be in the sequence "<month> <day> <year>". They also agree that the numbers 1 to 9 inclusive should be denoted by 01 to 09. These policy decisions (which are not enforced by the Enterprise Directory) mean that values can be ordered accurately. For example, the date "05 08 1963" is earlier than "12 31 1963".

## Customizing the Schema

### 6.5 Planning an Auxiliary Class

The team discussed using the generalized time syntax for this attribute, but decided that syntax required too much precision, and was not user friendly enough.

- They define a `hireDate` attribute.

This is similar to the `birthDate` attribute. It is to be optional, single-valued, with a numeric string syntax, for example, "01 06 1989".

- They define a `tmServer` attribute.

The `tmServer` attribute is single-valued with the distinguished name syntax. The value of the attribute is the X.500 distinguished name of an entry that represents a time management server. The attribute is optional.

Having planned the four new attributes that they want to use in employee entries, the Abacus team have to define the new attributes in the schema text files.

Section 6.5.1 describes how to edit the schema files to define an auxiliary class, and Section 6.5.3 explains how to define new attributes.

### 6.5.1 Defining an Auxiliary Class

An auxiliary class definition must conform to the following syntax:

```
classname OBJECT-CLASS SUBCLASS OF top AUXILIARY
  MUST CONTAIN {attribute [, attribute, ...]}
  MAY CONTAIN  {attribute [, attribute, ...]}
  ::= {object-identifier}
```

where:

- **classname** is the name of the class for which this is the definition.
- **attribute** is the name of an attribute type.

Specify each attribute that is to be permitted for this auxiliary class in the appropriate line according to whether it is mandatory or optional. If there are no mandatory attributes, omit that line, and similarly, if there are no optional attributes, omit that line.

- **object-identifier** uniquely identifies this class, for example, `customerObjectClass 1`.

See Section 6.3 for details of how to define your equivalent of the `customerObjectClass` identifier. The integer must be unique amongst definitions that use that identifier.

For example, the Abacus organization planned an auxiliary class called `abacusEmployee` in Section 6.5. The following example shows the class definition for that new class:

```
abacusEmployee OBJECT-CLASS SUBCLASS OF top AUXILIARY
  MUST CONTAIN {
    employeeNumber}
  MAY CONTAIN  {
    birthDate,
    hireDate,
    tmServer}
  ::= {abacusObjectClass 1}
```

Every attribute must also be defined in the schema (see Section 6.5.3). The list of attributes is case sensitive; you must use exactly the same string as you use when defining the attribute. For example, if the above list included the string `BirthDate`, the schema compiler displays an error, because the attribute definition uses a lowercase `b`.

You should also define a label for your new auxiliary class (see Section 6.6).

The example auxiliary class shown here states that it is a subclass of `top`, which means the definition inherits the attributes of that class. It is also possible to define an auxiliary class as a subclass of another auxiliary class. For example, having defined the `abacusEmployee` class, you could define a subclass of `abacusEmployee`. In that case, the subclass definition specifies that it is a `SUBCLASS OF abacusEmployee`.

## Customizing the Schema

### 6.5 Planning an Auxiliary Class

#### 6.5.2 DXIM Restrictions on the Use of Auxiliary Classes

The DXIM windows utility does not fully support the management of entries that are members of an auxiliary class. The Create and Modify windows only display attributes that are present in an entry because they are defined in the structural class definition. Any attributes that are defined in an auxiliary class are not displayed in those windows.

The DXIM command line utility does support management of auxiliary classes. For example, the following command modifies an existing `organizationalPerson` so that it is a member of the `abacusEmployee` auxiliary class (see Section 6.5.1). The command adds the name of the auxiliary class as a value of the `objectClass` attribute, and also specifies the mandatory `employeeNumber` attribute.

```
dxim> modify /c=us/o=abacus/ou=sales/cn="Jon Low" -
_dxim> add value objectclass=abacusEmployee -
_dxim> add attribute employeeNumber=1390921
```

You can also specify membership of an auxiliary class when you create an entry, as long as you also specify all attributes that are mandatory for all classes. For example:

```
dxim> create /c=us/o=abacus/ou=sales/cn="Jon Low" -
_dxim> attributes objectclass=(person,organizationalPerson,abacusEmployee), -
_dxim> surname=Low, employeeNumber=1390921
```

Although the DXIM windows utility only supports the creation and modification of attributes that are defined in an entry's structural class, it does display all attributes when you expand an entry in the Browse and Find windows.

#### 6.5.3 Defining Attributes

An attribute type definition must conform to the following syntax:

```
attributeName ATTRIBUTE
    WITH ATTRIBUTE-SYNTAX syntaxName [constraint]
    [EQUALITY MATCHING RULE matchingRuleName]
    [ORDERING MATCHING RULE matchingRuleName]
    [SUBSTRING MATCHING RULE matchingRuleName]
    [APPROXIMATE MATCHING RULE matchingRuleName]
    [SINGLE VALUED]
    STORE NORMALIZED | STORE ORIGINAL
    ::= {attributeType n}
```

where:

- `attributeName` is a descriptive name for your new attribute.

The mixture of uppercase and lowercase letters that you use in this descriptive name is the mixture that you must use in all references to this attribute type in other schema definitions.

- `syntax` is the name of the syntax to be used for the attribute.

You must specify one of the syntaxes documented in Section A.4, using the correct mixture of uppercase and lowercase letters. When choosing a syntax, consider what matching rules the syntax supports. The choice of syntax and matching rule determines whether the DSA can maintain an index for your new attribute (see Section 6.5.4).

## Customizing the Schema

### 6.5 Planning an Auxiliary Class

If none of the default syntaxes is suitable for your new attribute, you can use the `undefinedSyntax`. The only syntactic checking the DSA applies to this syntax is to ensure that the value is encoded in valid ASN.1. This syntax might be useful if, for example, you develop an application that has a particular syntax requirement not provided for by the other default syntaxes. However, because the DSA only checks the validity of the encoding, it is up to the application to monitor such attribute values for compliance with the intended format. Whenever possible, use a syntax for which the DSA can provide fuller support.

- `constraint` is an optional statement of a constraint on the size or range of a value.

For example, for string syntaxes, you can constrain values to be no more than 10 characters long by specifying `(SIZE(1..10))`. You can specify that a string must be exactly a certain length by specifying a single integer, for example, `(SIZE(10))`.

For integer syntaxes, you omit the `SIZE` keyword and the outermost parentheses. For example, you can constrain integer values to a range by specifying the lower and upper bounds of the range, for example, `(18..30)`.

If a constraint is specified for a list syntax, the constraint applies to each element of the list rather than to the list as a whole. For example, if you define an attribute that uses `integerListSyntax` and specify a range constraint of `(1..10)`, then each integer is constrained to that range.

- `matchingRuleName` is the name of a matching rule that is supported for the syntax of this attribute for the relevant type of matching: equality, substring, ordering, or approximate.

For example, for `stringSyntax`, an appropriate equality matching rule is `caseIgnoreStringMatch`, whereas an appropriate substring matching rule is `caseIgnoreSubstringMatch`.

Each matching rule must be defined elsewhere in the schema. Section A.4 lists the matching rules supported for each syntax, and Section A.5 specifies which types of matching the matching rules are suitable for.

It is advisable to specify at least an equality matching rule, even if you leave out the other types of matching rule. Without an equality matching rule, the DSA has no way of testing whether one value matches another. This makes it difficult to modify attributes, because the DSA cannot tell whether a value you try to add is already present in the entry, or whether a value you try to remove is present. This greatly complicates the management of the attribute.

If you use the `undefinedSyntax`, specify the `exactEncodingMatch` as an equality matching rule. This enables the DSA to provide simple matching of values even though the syntax is undefined.

See Section 6.5.4 for notes about choosing matching rules, especially if you are defining an attribute that you intend to use for naming entries.

- `SINGLE VALUED` means that the attribute can have only one value.

The absence of this clause means that the attribute can have any number of values.<sup>3</sup>

---

<sup>3</sup> Note that multi-valued attributes are stored as sets rather than sequences; that is, you cannot assume that the order in which you add values will be the order in which they are returned when you read an attribute. If you are defining an attribute for which one value is more important than another, see Section 6.5.3.1 for advice.

## Customizing the Schema

### 6.5 Planning an Auxiliary Class

- `STORE NORMALIZED` means that the DSA should normalize values of this attribute.

Normalizing an attribute involves optimizing its values so as to improve the performance of matching functions.

A typical effect of normalization is that multiple spaces embedded in a value specified by a user are reduced to one space. Thus, the value " John Smith " is normalized to "John Smith".

If a value is not stored normalized, then the DSA must normalize it every time it needs to compare it with a value specified by the user. This reduces the performance of the DSA for most user requests.

The decision to normalize or not also affects DXIM displays. If a value is stored normalized, then it is displayed in normalized form. However, if a value is stored in original form, then DXIM displays it accordingly.

The only reason to specify `STORE ORIGINAL` would be so that displays of attribute values exactly represent those values as they were originally entered by the user who added them to the directory. For example, if you consider it useful for embedded spaces to be preserved in the value, and displayed to users, then you can specify `STORE ORIGINAL` for the relevant attribute type. It is unlikely that this will be a useful choice.

See also Section 6.5.4 which explains that normalization improves the performance of an index of attribute values, which greatly improves the performance of searches, as well as most other requests.

- `n` is a unique number that identifies this attribute type.

For example, your first new attribute definition could be given the following object identifier:

```
 ::= {customerAttributeType 1}
```

Section 6.3 explains how to assign a value to `customerAttributeType` so that your definitions are guaranteed to be globally unique.

The following example illustrates a typical attribute definition, taken from the default schema:

```
commonName ATTRIBUTE
  WITH ATTRIBUTE-SYNTAX stringSyntax (SIZE(1..64))
  EQUALITY MATCHING RULE caseIgnoreStringMatch
  ORDERING MATCHING RULE caseIgnoreStringMatch
  SUBSTRING MATCHING RULE caseIgnoreSubstringMatch
  APPROXIMATE MATCHING RULE initialWordApproximateMatch
  STORE NORMALIZED
  ::= {attributeType 3}
```

When you define a new attribute, you can also define a label. A label specifies what the descriptive name of the attribute should be for the purposes of display in applications (see Section 6.6).

#### 6.5.3.1 Defining Primary and Secondary Attributes

It is important to understand that multi-valued attributes are stored by the DSA as sets rather than sequences. The order in which values are added to an attribute cannot be guaranteed to be the order in which they are returned when you read the attribute. Furthermore, the order in which values are returned on one occasion is not guaranteed to be used on another occasion.

This can influence your strategy for defining new attribute types. If a given attribute has one value that is particularly important for some reason, then you might consider defining an attribute type specifically for that value, and another attribute type for other values. For example:

```
favouriteSport ATTRIBUTE
    WITH ATTRIBUTE-SYNTAX stringSyntax (SIZE(1..64))
    EQUALITY MATCHING RULE caseIgnoreStringMatch
    ORDERING MATCHING RULE caseIgnoreStringMatch
    SUBSTRING MATCHING RULE caseIgnoreSubstringMatch
    APPROXIMATE MATCHING RULE initialWordApproximateMatch
    SINGLE VALUED
    STORE NORMALIZED
    ::= {attributeType 10007}

Sport ATTRIBUTE
    WITH ATTRIBUTE-SYNTAX stringSyntax (SIZE(1..64))
    EQUALITY MATCHING RULE caseIgnoreStringMatch
    ORDERING MATCHING RULE caseIgnoreStringMatch
    SUBSTRING MATCHING RULE caseIgnoreSubstringMatch
    APPROXIMATE MATCHING RULE initialWordApproximateMatch
    STORE NORMALIZED
    ::= {attributeType 10008}
```

In this example, the `favouriteSport` attribute is defined as single-valued. The Abacus organization could use this attribute to identify the sport that an employee most enjoys, while the multi-valued `Sport` attribute lists all sports that the employee participates in. In this way, each employee's favourite sport can be easily recognized by users and applications.

You might think of an attribute such as `favouriteSport` as a primary attribute, and `Sport` as a secondary attribute. It is up to the directory manager to ensure that such attributes are used for the purpose they are defined for; the DSA does not recognize the logical connection between such attributes.

#### 6.5.4 Planning to Index Attribute Values

The DSA can create indexes of attribute values. When you define new attribute types, you should consider whether you want the DSA to maintain an index for that attribute's values.

You can also consider whether you want the DSA to maintain indexes of the attributes defined in the default schema. The following sections explain the purpose of indexes, and how to make the DSA create and maintain an index of a given attribute's values.

##### 6.5.4.1 The Purpose of Indexes

If a DSA does not maintain an index for a given attribute, then when a user attempts to search for entries containing that attribute value, the DSA must check each possible entry in turn to see whether the attribute value matches. This requires the DSA to do a lot of processing. However, if a DSA maintains an index for the attribute, then the DSA can refer to the index to determine what entries have the relevant value. This is considerably faster than checking each entry in turn.

The use of indexing therefore greatly improves search performance, and is also useful for other user requests. However, indexing requires the DSA to use extra memory to store its attribute indexes. If your DSA system has limited resources, you need to decide whether to use indexing, or whether to use it only for certain

## Customizing the Schema

### 6.5 Planning an Auxiliary Class

attributes. An attribute value that is indexed is approximately 20 bytes larger than if it is not indexed.

The DSA can maintain two types of index for a given attribute, depending on what matching rules the attribute uses. Some attribute types cannot be indexed at all. See Section 6.5.4.2 for more details.

#### 6.5.4.2 Making a DSA Index a Given Attribute's Values

Not all attributes can be indexed. The ability to index a given attribute depends on which matching rules the attribute uses for equality matching and/or for approximate matching.

If the equality matching rule supports indexing, then the DSA can maintain an index that improves the performance of equality matching. Likewise, if an attribute has an approximate matching rule which supports indexing, then the DSA can maintain a separate index that improves approximate matching performance.

Although it is not possible to specify that you want an index for the purposes of substring matching or ordering matching, the DSA automatically uses the equality matching index if it is suitable. This depends on how complex the syntax is; for simple syntaxes, such as strings, it is often possible for the DSA to use an equality matching index for substring and ordering matching as well.

Consider the example of the `surname` attribute type from the default schema:

```
surname ATTRIBUTE
  WITH ATTRIBUTE-SYNTAX stringSyntax (SIZE(1..64))
  EQUALITY MATCHING RULE caseIgnoreStringMatch
  ORDERING MATCHING RULE caseIgnoreStringMatch
  SUBSTRING MATCHING RULE caseIgnoreSubstringMatch
  APPROXIMATE MATCHING RULE initialWordApproximateMatch
  STORE NORMALIZED
  ::= {attributeType 4}
```

The equality matching rule is `caseIgnoreStringMatch`, and the approximate matching rule is `initialWordApproximateMatch`.

To determine whether indexing is possible for the `surname` attribute, you need to refer to the definitions of these two matching rules. The definitions are as follows:

```
caseIgnoreStringMatch MATCHING-RULE
  WITH INDEX
  APPLIES TO
  stringSyntax, printableStringSyntax, countryNameSyntax
  ::= {matchingRule 21}

initialWordApproximateMatch MATCHING-RULE
  WITH INDEX
  APPLIES TO stringSyntax, printableStringSyntax
  ::= {decMatchingRule 3}
```

Both of the matching rule definitions include the keywords `WITH INDEX`. This indicates that those rules both support indexing, and therefore that it is possible to index the `surname` attribute for both types of matching.

When you choose the matching rules to be used for a new attribute type, check whether those matching rules support indexing. This may modify your choice of syntax.



To make a DSA actually index a given attribute type, having determined that one or both of the rules support indexing, you need to add the attribute's name to the `INDEX FOR EQUALITY MATCHING` and/or `INDEX FOR APPROXIMATE MATCHING` lists in `X500.SC`. For example, by default the `surname` attribute is specified in both lists. Therefore, by default the DSA creates an index of `surname` attribute values for both types of matching.

#### 6.5.4.3 Notes About Indexing Attribute Values

This section provides a list of factors to consider when deciding whether to use attribute indexes. By default, the schema specifies that all possible attribute types are indexed, because the performance gains are so great.

- If you want to use an attribute type as a naming attribute (see Section 4.4), then its equality matching rule must support indexing.

It is not necessary to actually use indexing, as long as indexing is possible for that attribute type. It does not matter whether the approximate matching rule, if any, supports indexing.

- If an attribute definition includes the `STORE ORIGINAL` clause, then the advantages of indexing that attribute's values are reduced.

If an index contains values that are in original form (see Section 6.5.3), the DSA must normalise each index entry to determine whether it matches the value specified by the user. An index is far more efficient if it contains normalized attribute values.

- An indexed attribute value requires approximately 20 bytes more memory than if it is not indexed.

If a DSA system has limited resources, you might decide to edit the `INDEX FOR EQUALITY MATCHING` and/or `INDEX FOR APPROXIMATE MATCHING` lists in `X500.SC`. By removing attributes from those lists you reduce the amount of memory required by the DSA. However, you also impact the performance of search and some other operations.

- There is no requirement for all DSAs to index the same set of attributes.

For example, the decision to index attribute values on one DSA does not require any other DSA to index the same attribute values, even if the other DSA holds some of the same directory entries.

- There is no requirement for a given attribute to be indexed for both equality matching and approximate matching.

If you expect that users will not use approximate matching frequently, then you might decide not to index any attributes for that purpose.

- The decision to index a given attribute applies to all directory entries held on the DSA.

## 6.6 Defining a Label

A label specifies alternative names for attributes, classes, and for DXIM windows (see Section 6.7.4).

Note that these labels affect DXIM and LDAP clients.

## Customizing the Schema

### 6.6 Defining a Label

The alternative names improve the DXIM user interface, so that users and managers are not exposed to unfriendly, unpunctuated attribute names, such as `stateOrProvinceName`. A label can specify abbreviations and user friendly alternatives for long and unfriendly descriptive names. You can also use labels to provide foreign language support within DXIM.

The default schema includes labels for all attributes. Most labels are defined in `DUA.SC`, and you can customize them as much as you like.

The syntax of a label definition is as follows:

```
LABEL labelName
  [KEYWORD "keyword", "keyword", ...]
  [MENU "text"]
  [DESCRIPTION "text"]
END
```

All parts of a label are optional. You can specify more than one keyword, but only one menu label and one description label. Keywords must not contain spaces, and must use the printable string character set only.

---

#### Note

---

If the schema files contain more than one label definition for an attribute, then the last definition takes effect, and all others are ignored. The schema compiler does not warn you that multiple label definitions have been found.

---

Menu labels and description labels can contain spaces, but must also use the printable string character set.

The following example shows the label definition for the `commonName` attribute.

```
LABEL      commonName
  KEYWORD  "CN", "common", "Name"
  MENU     "Name"
  DESCRIPTION "Common Name"
  END
```

where:

- **KEYWORD** specifies keywords that will be accepted in DXIM command line input to mean `commonName`.

The name of the attribute definition is always accepted as a keyword. For example, `commonName` is a valid keyword even though it is not listed.

The first listed keyword is the one that DXIM uses for the attribute if it appears in an entry's name and if information is being written to a script file. For example, DXIM would display `CN="John Smith"` rather than `commonName="John Smith"`. Choose a short first keyword so that displays of distinguished names are short.

With LDAP requests, the DSA tries to return attributes with the same name as used in the request. If all user attributes are requested, then the first keyword is used to return attributes.

A keyword is not required for window labels, because you never refer to windows in command lines.

- **MENU** specifies the string that is used by the DXIM windows interface whenever this attribute, class, or window appears on a menu.  
Specify only one text string for display on menus. The string can contain spaces, and is case sensitive.
- The **DESCRIPTION** line specifies the string that is used by DXIM when displaying information in a window.  
For example, the description is displayed when you show the attributes of an entry using the DXIM show command, or expand an entry in a DXIM window. Specify only one text string for display as a description. The string can contain spaces, and is case sensitive.

If you do not specify a label for an attribute type, DXIM uses the string that uniquely identifies the attribute type definition. For example, if there is no label for the `commonName` attribute type, such as Common Name, DXIM uses the string `commonName`. This behaviour also applies to any other schema definitions that are displayed in the user interface, such as object class names, window names, filter names, and so on. Most definitions in the default schema have labels. You can modify these labels if you do not like the defaults, or if English is not your users' first language.

## 6.7 Planning a Structural Class

This section demonstrates how to plan a new structural class when no existing classes are suitable for a given type of object that you want to represent.

---

### Note

---

Defining a new structural class is the most complicated of the possible schema customizations, requiring a detailed understanding of the X.500 model of information. For ease of implementation, it is better to use a standard structural class if possible, and to use auxiliary classes to extend the usefulness of the structural class (see Section 6.5).

---

The Abacus organization decides that it wants to represent dogs as directory entries. Many of the organization's security guards own a guard dog, and the organization decides that it will be useful to have directory entries representing them.

No existing structural class is suitable for representing a dog, so Abacus decides to define a new class, and several new attributes.

The organization decide to define a structural class called `dog`. The `dog` class is not derived from any other class except `top` (from which all classes are derived). Its only inherited attribute is therefore the `objectClass` attribute (all classes inherit the mandatory and optional attributes of the classes from which they are derived).

---

### Note

---

You can define a structural class as a *subclass* of an existing structural class. In this case, the new subclass inherits the attributes permitted for its *superclass*.

## Customizing the Schema

### 6.7 Planning a Structural Class

However, if there is a structural class that is suitable for this approach, then defining an auxiliary class is easier and more flexible than defining a subclass. Section 6.5 describes how to plan an auxiliary class.

---

The organization decide that the attributes of each dog are `commonName`, `breed`, `birthDate`, and `handler`.

The `commonName` attribute is a standard attribute provided by the default schema. It therefore requires no further planning, except to state that it is mandatory for a dog to have a common name.

The `breed` attribute is a new attribute. It is to be single-valued, mandatory, and have a printable string syntax.

The `birthDate` attribute is the same as the one planned in Section 6.5, and requires no further planning except to state that it is optional for dogs.

The `handler` attribute is a new attribute. It is to be single-valued, optional, and have a distinguished name syntax. It is to contain the distinguished name of the security guard who is responsible for the dog.

Note that the organization deliberately reuses existing attribute definitions where possible, so that the amount of planning and implementation required is kept to a minimum, and so that information is represented as consistently as possible, even for different classes of entry. Defining new attributes for use with a structural class is the same as for an auxiliary class. Section 6.5.3 explains how to define a new attribute.

The planners decide that all `dog` entries must be named using the `commonName` attribute. They need to define a name form for this rule. Section 6.7.2 explains how to define a name form for a new structural class.

The organization also decide that `dog` entries are to be created as subordinates of `organizationalUnit` or `locality` entries. They need to define some structure rules in the schema. Section 6.7.3 explains how to define structure rules for a new structural class.

Section 6.7.1 explains how to edit the schema text files to define a new structural class, such as `dog`. Section 6.7.4 explains how to define a window definition for a new structural class.

Defining a label for a structural class is the same as for an auxiliary class. Section 6.6 explains how to define a label.

#### 6.7.1 Defining a Structural Class

A structural class definition must conform to the following syntax:

```
classname OBJECT-CLASS SUBCLASS OF superclass STRUCTURAL
    MUST CONTAIN {attribute [, attribute, ...]}
    MAY CONTAIN {attribute [, attribute, ...]}
    ::= {object-identifier}
```

where:

- `classname` is the name of the class for which this is the definition
- `superclass` is the name of the immediate superclass of this class

## Customizing the Schema 6.7 Planning a Structural Class

For example, most classes are immediate subclasses of `top`, but the `organizationalPerson` class is a subclass of `person`. If you define a class as a subclass of another class, then list the immediate superclass only. The superclass of a new structural class must itself be either a structural class or an abstract class. You cannot define a structural class to be a subclass of an auxiliary or alias class.

It is also possible for a class to be a subclass of two or more different classes. Only one of the immediate superclasses can be a structural class. All but one of the specified superclasses must be abstract classes. An abstract class is defined to provide a common basis for the definition of further classes. For example, you could define a `mammal` abstract class, to provide a common basis for defining structural classes such as `cat` and `dog`. For most purposes, this additional complexity is probably unnecessary.

If you want to define a class as a subclass of more than one superclass, list each immediate superclass from which your new class is derived, using commas as separators. For example:

```
classname OBJECT-CLASS SUBCLASS OF superclass,superclass STRUCTURAL
```

---

### Note

---

Do not confuse the concept of superclasses with the concept of permitted superiors in the DIT. The former helps to define classes in the schema, while the latter helps to define permitted relationships in the DIT.

For example, the `organizationalPerson` class has the superclass `person`. That superclass hierarchy is different from the rules that specify that `organizationalPerson` entries can have `organization`, `locality`, or `organizationalUnit` entries as permitted superiors in the DIT.

---

- `attribute` is the name of an attribute type.
- `object-identifier` uniquely identifies this class, for example, `customerObjectClass 1`.

See Section 6.3 for details of how to define your equivalent of the `customerObjectClass` identifier. The integer must be unique amongst definitions that use that identifier.

All of the specified superclasses and attribute types must also be defined in the schema.

The planner's task is to write such a definition for each new structural class. The following example shows the class definition for the new `dog` class:

```
dog      OBJECT-CLASS SUBCLASS OF top STRUCTURAL
  MUST CONTAIN {
    commonName,
    breed}
  MAY CONTAIN {
    birthDate,
    handler}
  ::= {abacusObjectClass 100}
```

## Customizing the Schema

### 6.7 Planning a Structural Class

#### 6.7.2 Defining Name Forms

When you define a structural class, you must also define a name form. A name form specifies what attribute is to be used for naming entries of a given class.

The syntax of a name form is as follows:

```
nameFormName NAME-FORM
  NAMES class
  WITH ATTRIBUTES attribute_list
  [AND OPTIONALLY attribute_list]
  ::= {object-identifier}
```

where:

- `nameFormName` is a unique name for this name form.
- `class` is the name of the class to which this name form applies.
- `attribute_list` is a list of one or more attributes.

All attributes used for naming must support storage optimization (see Section 6.5.4).

- `object-identifier` uniquely identifies this name form, for example, `customerNameForm 1`.

See Section 6.3 for details of how to define your equivalent of the `customerNameForm` identifier. The integer must be unique amongst definitions that use that identifier.

For example, in Section 6.7 the Abacus organization decided that entries of the `dog` class would be named using the `commonName` attribute. The following example shows the name form that defines this rule.

```
dogNameForm NAME-FORM
  NAMES dog
  WITH ATTRIBUTES commonName
  ::= {abacusNameForm 100}
```

It is possible to specify more than one naming attribute. To specify a set of attributes that must be used in naming, list the attributes, using commas to separate them. For example, the following `WITH ATTRIBUTES` clause would specify that each of `commonName` and `handler` must always be used in naming dog entries:

```
dogNameForm NAME-FORM
  NAMES dog
  WITH ATTRIBUTES commonName, handler
  ::= {abacusNameForm 100}
```

It is also possible to specify that a naming attribute is optional for the purposes of naming, using the `AND OPTIONALLY` clause. For example, the following name form specifies that `commonName` is required in names of dog entries, but that `handler` and `breed` are both optional:

```
dogNameForm NAME-FORM
  NAMES dog
  WITH ATTRIBUTES commonName
  AND OPTIONALLY handler, breed
  ::= {abacusNameForm 100}
```

Note that an attribute can be listed as mandatory or optional for naming, regardless of whether the attribute is mandatory or optional according to the class definition.

The last line of the name form definition assigns an object identifier that uniquely identifies this name form within the schema.

### 6.7.3 Defining Structure Rules

When you define a structural class you must also define one or more structure rules.

Alias classes (see Section 6.8) also have structure rules, which are defined in the same way. Auxiliary classes do not have structure rules.

Conceptually, there are two types of structure rule:

- Those that permit entries to be created immediately beneath the root of the DIT
- Those that permit entries to be created beneath other specified classes of entry

If you do not define any structure rules for your new classes, then your DSA does not allow you to create entries of those classes. You must define rules that specify where entries are permitted in the DIT, as well as defining what attributes they have.

#### 6.7.3.1 Structure Rules for Entries Immediately Beneath the Root

The syntax of a structure rule that permits entries to be created immediately beneath the root of the DIT is as follows:

```
structureRuleName STRUCTURE-RULE
    NAME FORM nameFormName
    ::= integer
```

where:

- `structureRuleName` is the name of the rule that you are defining.
- `nameFormName` specifies a name form for all entries that use this structure rule.
- `integer` is a number that uniquely identifies this rule.

Note that structure rules do not have object identifiers, unlike most definitions. Specify an integer that is unique within your schema. See Section 6.7.3.3 for advice about assigning structure rule identifiers.

For example, the following structure rule permits `organization` entries to be created immediately beneath the root:

```
organizationRootStructureRule STRUCTURE-RULE
    NAME FORM organizationNameForm
    ::= 3
```

Note that it is unlikely that you will need to define classes of entry that can be created immediately beneath the root, because that will probably exceed your authority to create and name entries.

Note that this rule does not permit `organization` entries to be created anywhere else in the DIT. Any class that can be created beneath other entries needs a slightly different structure rule (see Section 6.7.3.2). Some classes of entry therefore have two structure rules, so that they can be created beneath the root or created beneath other classes of entry.

## Customizing the Schema

### 6.7 Planning a Structural Class

#### 6.7.3.2 Structure Rules for Entries Beneath Other Entries

The syntax of a structure rule that permits entries to be created beneath other classes of entry is as follows:

```
structureRuleName STRUCTURE-RULE
  NAME FORM nameFormName
  SUPERIOR RULES ruleName [, ruleName, ...]
  ::= integer
```

where:

- `structureRuleName` is the name of the rule that you are defining.
- `nameFormName` specifies a name form for all entries that use this structure rule.
- `ruleName` is the name of a structure rule that enables the existence of entries that are to be immediately superior to the entries for which this is the structure rule.
- `integer` is a number that uniquely identifies this rule.

For example, the following rule permits an `organizationalPerson` entry to be created beneath `organization`, `organizationalUnit`, and `locality` entries:

```
organizationalPersonStructureRule STRUCTURE-RULE
  NAME FORM organizationalPersonNameForm
  SUPERIOR RULES
    organizationStructureRule, organizationRootStructureRule,
    localityStructureRule, localityRootStructureRule,
    organizationalUnitStructureRule
  ::= 7
```

Note that the list of superior rules includes the rule that permits `organization` entries beneath the root, and the rule that permits `organization` entries beneath other classes of entry. This means that an `organizationalPerson` entry can be created beneath any `organization` entry regardless of what superiors the `organization` may or may not have. If only one of the two rules is listed, it is only possible to create an `organizationalPerson` entry beneath `organization` entries that conform to the one rule listed.

Similarly, the list of superior rules includes the rule that permits `locality` entries beneath the root, as well as the rule that permits `locality` entries beneath other entries.

See Section 6.7.3.4 for an example of the definition of structure rules for a new structural class.

---

#### Note

---

If you define a structural class, you might want to be able to create entries of a standard class beneath entries of your new class. For example, you might define a `team` class, and then want to be able to create standard `organizationalPerson` entries beneath `team` entries.

To achieve this, you need to amend the structure rule of the `organizationalPerson` class to add the `teamStructureRule` as one of its `SUPERIOR RULES`. Structure rules for default classes are defined in `DIT.SC`.

This ability to amend the structure rules of existing definitions is particularly important for the `decDSA` class, which is required for the



implementation of security. If you intend to use a customer-defined class of entry as the immediate superior of `decDSA` entries, then you must amend the structure rule for the `decDSA` class to make this possible. If you do not make this amendment, you will be unable to create `decDSA` entries in the intended position, and will be unable to implement security in the recommended way.

---

### 6.7.3.3 Assigning Structure Rule Identifiers

Every structure rule requires an identifier that is unique within your schema. You need to assign an identifier to each structure rule you define.

There is a danger that future versions of the Enterprise Directory might include new rules with identifiers that clash with your customizations. For this reason, Compaq reserves integers in the range 10000 to 19999 for your use. You are advised to assign integers from within that range, and thereby avoid any danger of clashing with future additions to the default schema.

The upper limit to the integer values that you use for structure rules is  $2^{31}-1$ .

### 6.7.3.4 Structure Rule Definitions: An Example

This section provides an example of how to define structure rules for a new structural class.

The Abacus organization in Section 6.7 defined a structural class called `dog`. They therefore need to define one or two structure rules that enable `dog` entries to be created in the required positions in the DIT.

The Abacus organization wants to be able to create `dog` entries beneath `organizationalUnit` entries, and `locality` entries. They do not want to be able to create `dog` entries immediately beneath the root of the DIT. (That latter requirement would be unusual.) They therefore need to define one structure rule, as follows:

```
dogStructureRule STRUCTURE-RULE
  NAME FORM dogNameForm
  SUPERIOR RULES
    organizationalUnitStructureRule,
    localityStructureRule, localityRootStructureRule
  ::= 10001
```

Note that the superior rules list actually specifies three superior rules. This is because the `locality` class is an example of a class that can be created beneath the root of the DIT as well as beneath other entries. The `locality` class therefore has two structure rules, and both are listed. If either of the two rules for the `locality` class are not specified, then `dog` entries cannot be created beneath any `locality` entries that conform to the unspecified rule.

Note that the list of superior rules cannot include any structure rules defined for alias classes. Alias classes cannot have subordinate entries.

## 6.7.4 Defining Window Definitions

When you define a new class, you also need to create a window definition (assuming that you want to use the DXIM windows interface to create and modify entries of this class).

## Customizing the Schema

### 6.7 Planning a Structural Class

A window definition specifies the appearance of the DXIM Create and Modify windows. If you do not define a window definition for a new class, then the DXIM windows interface will not have a Create or Modify window for that class. The DXIM support of the class is therefore limited to browsing and finding, rather than creating and modifying.

In Section 6.7, the Abacus organization planned a dog class. Section 6.7.1 explains how to implement the dog class in the schema, and the following example shows the window definition.

```
dogWindow WINDOW
  FOR CLASS dog
  NAMING ATTRIBUTES {
    commonName}
  ATTRIBUTES {
    breed,
    handler,
    birthDate}
  END
```

where:

- The **FOR CLASS** line specifies what class of entry this definition is for.
- The **NAMING ATTRIBUTES** line specifies the attributes that are used for naming entries of this class, and must correspond to the name form for this class. Do not put any other attributes here.
- The **ATTRIBUTES** line specifies a list of attributes that are not used for naming.

The list must include all mandatory attributes for the class, except for the **objectClass** attribute. If you do not include all other mandatory attributes, then you will be unable to create entries of the class.

You do not have to list all optional attributes for the class if there are some attributes that you never use, or that are too technical and application-specific to display. However, a class's window should display all attributes that you are likely to use and manage, and in particular, the naming attributes must always be specified in the **NAMING ATTRIBUTES** line.

Do not list any attributes that are not displayable because of access controls (see Chapter 7). For example, do not list the **userPassword** attribute, because DXIM will be unable to display it, and attempts to modify it will fail. Such attributes can only be managed using the command line interface.

If you define a class as a subclass of another class, then remember that the subclass inherits the attributes of its superclass. Therefore, you need to consider which inherited attributes you want to display. You can list the attributes in any order, regardless of whether they are inherited. The order that you list them in determines their order of display in Create and Modify windows. Remember that if an attribute is mandatory for a superclass, then it is also mandatory for all subclasses, and needs to be included in the list.

### 6.8 Planning Alias Classes

If you define a new structural class, then you might also want to define an alias class that mimics it.

For example, the default schema contains an alias class called `organizationalPersonAlias` which is designed to mimic the `organizationalPerson` structural class. This enables you to create alias entries that look as though they are `organizationalPerson` entries, but which are actually alias entries. The alias class is defined to have the same name form and structure rules as the structural class that it mimics.

The syntax of an alias class definition is as follows:

```
classname OBJECT-CLASS SUBCLASS OF alias ALIAS
  MUST CONTAIN {attribute [, attribute, ...]}
  MAY CONTAIN  {attribute [, attribute, ...]}
  ::= {object-identifier}
```

where:

- `classname` is the name of the class for which this is the definition.
- `attribute` is the name of an attribute type.  
Specify each attribute that is to be permitted for this alias class in the appropriate line according to whether it is mandatory or optional.
- `n` is a unique number that identifies this class.
- `object-identifier` uniquely identifies this class, for example, `customerObjectClass 1`.  
See Section 6.3 for details of how to define your equivalent of the `customerObjectClass` identifier. The integer must be unique amongst definitions that use that identifier.

For example:

```
dogAlias OBJECT-CLASS SUBCLASS OF alias ALIAS
  MUST CONTAIN {commonName}
  ::= {abacusObjectClass 5}
```

The attribute `commonName` is specified because that is the attribute that is defined as the naming attribute of the `dog` structural class (see Section 6.7.1). The `dogAlias` definition could specify other attributes as mandatory or optional, but the purpose of an alias entry is only to provide an alternative name for another entry; not to hold information in its own right.

Because the alias class is defined as a subclass of the `alias` class, it inherits the `aliasedObjectName` attribute. This is the attribute that you use to hold the distinguished name of the entry for which you have created a given alias entry.

If you define an alias class, you need to define a name form and one or more structure rules. The definitions for these are the same as the name forms and structure rules of structural classes, and are described in Section 6.7.

There is no requirement for an alias class to have the same naming attributes as the class of entry that it is intended to provide an alias for. Similarly, there is no requirement for an alias class to have the same structure rules. In fact, there is no defined relationship between an alias class and any other class, and you could use an alias to provide an alias name for any other entry, regardless of class. For example, you could create a `roleAlias` class which you use to provide aliases for both `organizationalPerson` entries and `organizationalRole` entries.

## Customizing the Schema

### 6.8 Planning Alias Classes

Finally, when you define a new alias class, you need to define a window definition for it, so that the DXIM windows utility can display entries of this class consistently (see Section 6.7.4). You can also define labels for the alias class so that when its name appears on menus and screen displays, it looks user friendly (see Section 6.6).

For example, the set of definitions required for an alias class that mimics the dog structural class (see Section 6.7), is as follows:

```
dogAlias OBJECT-CLASS SUBCLASS OF alias ALIAS
  MUST CONTAIN {
    commonName
  }
  ::= {abacusObjectClass 5}

dogAliasNameForm NAME-FORM
  NAMES dogAlias
  WITH ATTRIBUTES commonName
  ::= {abacusNameForm 5}

dogAliasStructureRule STRUCTURE-RULE
  NAME FORM dogAliasNameForm
  SUPERIOR RULES organizationalUnitStructureRule,
                  localityStructureRule, localityRootStructureRule
  ::= 10002

dogAliasWindow WINDOW
  FOR CLASS dogAlias
  NAMING ATTRIBUTES {commonName}
  ATTRIBUTES {
    aliasedObjectName
  }
  END

LABEL dogAlias
  KEYWORD "dogAlias"
  MENU "Dog Alias"
  DESCRIPTION "Dog Alias"
  END
```

Note that the integer specified for the structure rule is in the range 10000 to 19999, as recommended in Section 6.7.3

See Section 6.7.4 for further details of window definitions. See Section 6.6 for further details of labels. See Section 6.7.2 for further details of name forms. See Section 6.7.3 for further details of structure rules.

## 6.9 Defining Search Filters and Filter Fields for the Windows Utility

The DXIM Find window provides a simplified interface to the search services provided by the Enterprise Directory.

The purpose of the simplifications is to minimize the amount of X.500 knowledge required by end users of DXIM, making the windows utility suitable for end users as well as managers. A typical end user of the Directory Service might know a person's name, but might not understand that a name can be represented using several different attributes.

The schema provided with the product includes user friendly filters for all of the classes defined in the default schema. If you define any new classes or attributes, then you probably need to customize the filters so that they support those new definitions.

## 6.9 Defining Search Filters and Filter Fields for the Windows Utility

All filters are defined in the schema file DUA.SC. There are actually two sets of definitions:

- Filter definitions
- Filter field definitions

Depending on what customizations you make to the schema, you might want to create new filter definitions and/or new filter field definitions, or you might want to amend existing definitions.

Section 6.9.1 explains the syntax and significance of filter definitions, and Section 6.9.2 explains the syntax and significance of filter field definitions.

### 6.9.1 Search Filter Definitions

A search filter provides a template for search requests that users are most likely to want to make. For example, a search filter might be designed to simplify the task of searching for entries representing people.

Each search filter specifies a list of fields which can be presented to the user as suitable things to search for, such as names. The user does not need to know exactly what X.500 attributes these fields map onto, and does not need to understand the semantics of the X.500 search service.

A search filter appears to the user as a menu option on the left side of the DXIM Find window. The user selects the type of information they want to search for, and the window displays a relevant field on the right side (typically the Name field). Figure 6–1 shows the Find window with the Person filter selected on the left side, and the Name field on the right side.

Figure 6–1 DXIM Find Window

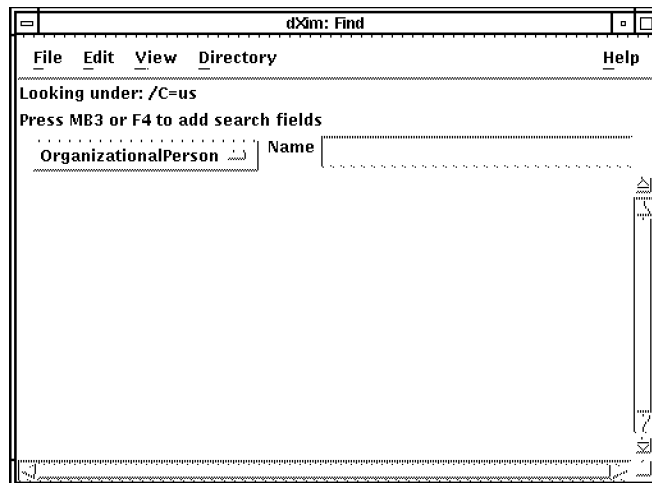

The syntax of a filter definition is as follows:

## Customizing the Schema

### 6.9 Defining Search Filters and Filter Fields for the Windows Utility

```
filtername FILTER
  WITH FIELDS {fieldname, fieldname, ...}
  [ AND VALUES
    {ATTRIBUTE attribute = "value", "value", ...}
  ]
END
```

where:

- `filtername` is the name of this filter definition.
- The `WITH FIELDS` argument specifies which filter fields are to be available to the user when using this filter (see Section 6.9.2).

If the user fills in a field, then the search only finds entries that match the details they specify. If the user fills in several fields, then the search only finds entries that match all the specified details. See Section 6.9.2 for an explanation of what constitutes a match for a given field.

- The `AND VALUES` argument enables you to specify attribute values that are always to be included in searches using this filter. The search only finds entries that match all of the details specified.
  - The `ATTRIBUTE` argument enables you to specify one or more attribute values that are to be included in all searches using this filter.

For example, you could specify that all searches include the specification that `objectClass=person`. This means that when the user uses this filter, the search only returns entries of that class. Entries that match the details provided by the user are excluded from the search if they are not also of the `person` class.

You can specify the `ATTRIBUTE` argument more than once, to specify a list of attribute values that must be included in all searches using this filter. If you specify more than one `ATTRIBUTE` argument, then the search must match all of the attribute values listed.

For example, the default schema contains an `organizationalPerson-filter`, as follows:

```
organizationalPerson-filter FILTER
  WITH FIELDS {
    nameField,
    descriptionField,
    locationField
  }
  AND VALUES
    {ATTRIBUTE objectClass = "organizationalPerson" }
END
```

The filter specifies that three filter fields are available to the user. The filter also specifies that all searches using this filter must include the attribute value `objectClass=organizationalPerson`.

Thus, if the user uses the `nameField` in the DXIM Find window, and specifies "Jones", then DXIM actually invokes a search that looks for entries of the `organizationalPerson` class in which at least one of the attributes listed in the `nameField` has the value Jones.

## 6.9 Defining Search Filters and Filter Fields for the Windows Utility

### 6.9.1.1 Customizing Search Filter Definitions

The most likely customizations to make to search filter definitions are as follows:

- To include another object class in an existing filter.

For example, if you define an object class such as `abacusEmployee`, (see Section 6.5.1), then you could simply amend the `organizationalPerson-filter` definition, to specify that all searches using that filter include that new class.

Thus, the filter becomes:

```
organizationalPerson-filter FILTER
  WITH FIELDS {
    nameField,
    descriptionField,
    locationField
  }
  AND VALUES {
    ATTRIBUTE objectClass = "organizationalPerson", "abacusEmployee"
  }
END
```

- To create a new filter definition.

If you create a new class, for which no existing filter is suitable, you can define a new filter. The new filter appears on the menu of options presented on the left side of the DXIM Find window. The filters are listed in the order that they are defined in the schema.

If you define a new filter, then you should also define a label for the filter, to give it a user friendly appearance on the menu.

- To delete a filter definition.

If some of the filters in DUA.SC are designed for classes of entry that you do not use in your DIT, or classes that you do not want end users to search for, you can delete or comment out the filter definition. This removes the option from the menu of options in the Find window.

If you remove a filter, you must also remove the corresponding label.

- To specify a particular attribute value that must be present in all entries returned by a search using a given filter.

You can also change the label definition of each filter so that it presents the search option in a way that your users will understand. For example, you could change the label of the `organizationalPerson-filter` to be `Employee` instead of `organizationalPerson`, or similarly, if you only use the `organizationalRole` class to represent managers, then you could change the label of the `organizationalRole-filter` to be `Manager` instead.

### 6.9.2 Filter Field Definitions

A filter field provides a user friendly interface to X.500 attribute types. A single filter field can map onto any number of attribute types, giving them the appearance of being one attribute. The end user therefore does not need to know exactly which attribute type is being used to store a particular item of information.

For example, the `nameField` maps onto a number of attributes: `commonName`, `surname`, `title`, `organizationName`, and `organizationalUnitName`. As far as the end user is concerned, all they need to specify is a "name".

## Customizing the Schema

### 6.9 Defining Search Filters and Filter Fields for the Windows Utility

If a user fills in a filter field, then the search only finds entries which have the specified value in at least one of the attribute types specified as being part of the filter field. For example, if the user specifies `Name=Smith`, then entries with a `commonName` and/or `surname` and/or `title` and/or `organizationName` and/or `organizationalUnitName` with the value `Smith` are found.

A filter field appears to the user as an input field on the right side of the DXIM Find window. Whatever the user types into that input field is processed by DXIM into a search request. The value specified by the user is searched for in all of the attributes listed in the filter field definition. Figure 6–2 shows the DXIM Find window with several fields displayed. Each of the fields is listed within the filter definition for the Person filter.

Figure 6–2 DXIM Find Window Showing Filter Fields

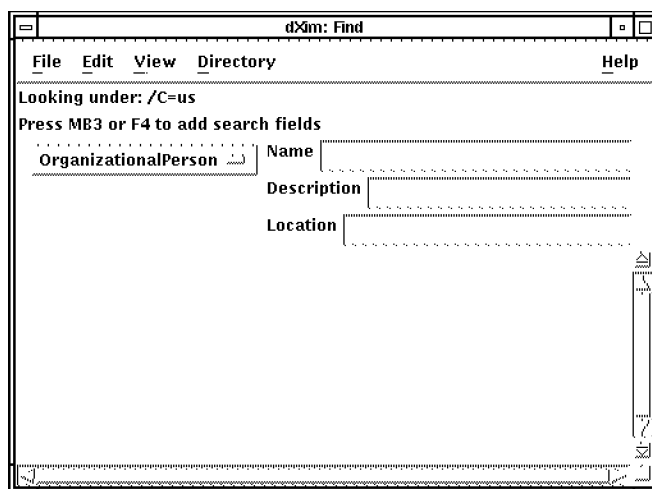

The syntax of a filter field definition is as follows:

```
fieldname FILTER-FIELD
    ATTRIBUTES {attribute, attribute, ...}
END
```

where `attribute` is the name of an attribute that is included in this filter field.

For example, the default schema contains a `nameField` filter field:

```
nameField FILTER-FIELD
    ATTRIBUTES {commonName,
                surname,
                title,
                organizationName,
                organizationalUnitName}
END
```

To make the filter field name appear user friendly in the window, the schema also contains a label definition:

```
LABEL nameField
    MENU "Name"
END
```



## 6.9 Defining Search Filters and Filter Fields for the Windows Utility

See Section 6.6 for details of label definitions.

The definition of the filter field means that when a user supplies the value Jones, DXIM generates a search request that looks for entries that have the value Jones in any of the above attributes. This means that the user does not need to understand about different attribute types, and does not have to know which particular attribute to specify. As far as the user is concerned, the entry they are searching for simply has the name Jones, and DXIM supports this user expectation.

### 6.9.2.1 Customizing Filter Field Definitions

The most likely customizations to filter fields are as follows:

- To add another attribute to an existing filter field.

If you define a new attribute (see Section 6.5.3) you might want to include it in an appropriate filter field.

- To create a new filter field.

If you define a new filter field, you also need to define a search filter that uses it, or add the filter field to the list of filter fields for an existing search filter.

- To remove an attribute from a filter field.

If a filter field contains attributes that you never use in your DIT, or that you do not want users to search on, then you can remove the attribute from the list. DXIM always searches for all of the listed attributes, so by reducing the list you can improve the performance of searches.

Note that a given filter field can be used by more than one search filter. If you decide to delete an attribute from a filter field, remember that the lack of that attribute might reduce the usefulness of the filter field in some of the search filters that use it.



---

## Controlling Access to Your Directory Information and Services

This chapter describes how to plan access controls for your DIT. Access controls enable you to control the interrogation and modification of directory information.

This chapter also describes a method of controlling access to DSAs (rather than to the information they hold). If you have implemented `decDSA` entries and replication in the ways recommended by Chapter 4 and Chapter 5, then controlling access to DSAs is not required, and its disadvantages outweigh its advantages. However, if you have not implemented the recommended method, or you have a strong requirement to control access to a specific DSA, this chapter explains an alternative method.

### 7.1 The Default Access Control

Implementing access control is not mandatory; nor does access control have to be implemented immediately. Compaq DSAs have a default access control configuration that applies to all information until you decide to implement something different.

By default, Compaq's DSAs allow everyone all access to all information except for the `userPassword` attribute. Users are not allowed to display passwords or search for them. For example, you cannot search for all entries with a specific password.

If this default level of access control is sufficient for your needs, then you do not need to read this chapter.

However, it is likely that you will eventually want to implement more restrictive controls, especially if other organizations will have access to your Enterprise Directory. If so, proceed to Section 7.2.

### 7.2 The Access Control Template File

To simplify the task of implementing non-default access control, Compaq provides a template file. The template file contains two `DXIM` commands that, when completed and executed, create an ***access control subentry*** in your DIT. Your task is to specify the name of the access control subentry, and the directory names of the users who are to have management privileges.

If the template file does not meet your needs, you can customize it. You can change and execute the template more than once, if you decide that you need to change the access controls.

You can set up access control at the same time as you populate your DIT, or at any time afterwards.

To plan the name of the access control subentry, see Section 7.3. If you want an overview of the access controls defined in the template file, see Section 7.4.

# Controlling Access to Your Directory Information and Services

## 7.3 Planning the Name of the Access Control Subentry

### 7.3 Planning the Name of the Access Control Subentry

This section recommends a simple way to implement access controls. It assumes that you have planned your DIT as described in Chapter 5 and illustrated in Figure 7-1.

Figure 7-1 also shows the recommended position for the access control subentry. It is positioned immediately subordinate to the highest entry in the Abacus DIT. As such, the access control subentry is replicated as part of Naming Context A. Chapter 5 recommends that your equivalent of Naming Context A is replicated to all DSAs.

Figure 7-1 Recommended Position for Creating an Access Control Subentry

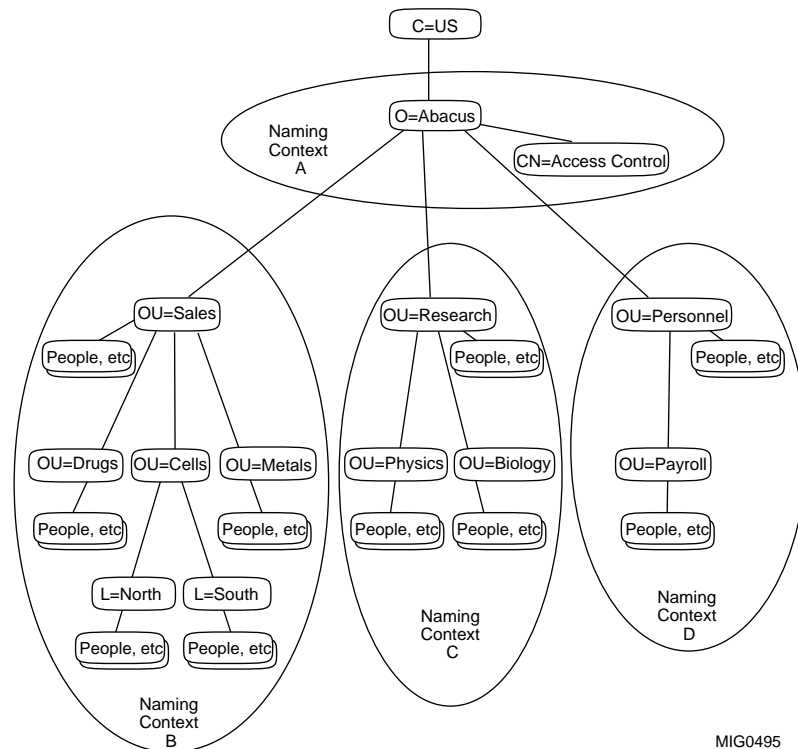

The name of the access control subentry shown in Figure 7-1 is `/C=US/O=Abacus/CN="Access Control"`.

---

#### Note

---

Subentries are a special class of entry to which normal structure rules do not apply<sup>1</sup>. A subentry must be created as an immediate subordinate of an entry that is at the top of a naming context. Unlike other classes, it does not matter what class of entry the superior is, as long as it is at the top of a naming context.

---

<sup>1</sup> Another feature of subentries is that they are usually hidden from users of the directory unless named explicitly. For example, if you search the directory or show the subordinates of an entry, subentries are hidden by default. These two commands provide a parameter that enables you to indicate that you want to see subentries. Refer to the online help for the DXIM command line utility for further details of the subentries control.

## Controlling Access to Your Directory Information and Services

### 7.3 Planning the Name of the Access Control Subentry

In this example, none of the other three naming contexts contain an access control subentry. Any naming context that has no access control subentry can inherit<sup>1</sup> the access controls specified for a superior naming context that is held on the same DSA. Therefore, by replicating your equivalent of Naming Context A to all DSAs, you can ensure that all the other naming contexts inherit the same access controls.

Thus, creating one access control subentry entry in the recommended position has the following advantages:

- You have consistent access controls for your entire DIT.
- You change access controls for your entire DIT by managing that single subentry.
- You can analyze access control problems by reference to that single subentry.

Note that you could implement independent access controls for each naming context, but unless there is a security requirement to do this, or you have not followed Compaq's recommended replication model, it merely complicates the management of access control.

When you have decided where you need to create your access control subentry, and what its name will be, the only other thing that you need to plan is which users are to be information managers. Each directory information manager needs to be represented by a directory entry, and each of those entries needs a `userPassword` attribute. When you have all of this planned, you can complete and execute the template file as described in Chapter 11.

If you want to know what access controls the file defines, see Section 7.4.

## 7.4 What the Access Control Template File Does

This section provides an overview of the access controls defined in the template file.

If these controls are suitable for your directory information, then all you need to do is insert the name of the access control subentry that the template file creates, and the names of people who are to have management access to the directory. You can then execute the file as described in Chapter 11.

The template defines four access control information items (ACIitems), as follows:

- The "Directory Managers" ACIitem.  
This gives specified users full access to all information except passwords. It indicates that the named users must provide their name and password (simple authentication) in order to be granted this access.
- The "Authenticated users" ACIitem.  
This applies to users who have authenticated themselves to the directory, but who are not directory managers. It enables such users to use the Compare service to check passwords. This access is required by DSAs as part of normal operation. Do not remove or override this ACIitem.
- The "Unauthenticated users" ACIitem.

---

<sup>1</sup> See Section 7.6 for a detailed discussion of the scope and inheritance of access controls.

## Controlling Access to Your Directory Information and Services

### 7.4 What the Access Control Template File Does

This applies to users who do not authenticate themselves. It grants many types of access, but excludes all forms of modification. It also explicitly denies access to the `userPassword` attribute.

- The "Own entry" ACItem.

This applies to users who authenticate and then attempt to access their own entry. It grants modification access to their entry, and full access to a list of attributes. It permits a user to compare, add, and remove their own `userPassword` attribute. It does not allow a user to delete or rename their entry.

It also grants a user access to their own `presentationAddress`, `protocolInformation`, and `supportedApplicationContext` attributes.

These attributes are specified so that Compaq's DSAs can keep their own entries up to date. Do not remove or override this aspect of the ACItem.

Compaq suggests that these four ACItems should provide effective control to your directory information, at least until you have had time to understand the complexities of access control. Chapter 11 explains how to use the template file.

### 7.5 Customizing Access Controls

If the access controls specified by the template file do not meet your needs, you can customize the file, or create a completely different file.

If you want to customize access controls, you really need to understand:

- Which access controls are required for the normal operation of the Enterprise Directory itself.

Compaq DSAs are themselves users of the Enterprise Directory. You need to ensure that they have the access that they need. This is discussed in Section 7.5.1

- Which access controls are required by managers of directory information.

For example, the ability to change access controls is itself controlled by access control. A directory information manager requires certain access rights. These are discussed in Section 7.5.2.

- The composition of ACItems.

Each ACItem is composed of three elements. This is discussed in Section 7.5.3.

- How ACItems that contradict each other are applied.

ACItems are ranked according to their precedence and how specific they are about the user or the directory information they refer to. You need to understand how this ranking works, so that you can assign the correct precedence to a given ACItem. See Section 7.5.4 for a discussion of this topic.

- The DXIM command line syntax for defining access controls.

Appendix B documents the DXIM syntax for specifying access controls, and the template file provides an excellent example.

### **7.5.1 Access Controls Required for Normal Operation of the Enterprise Directory**

Some of the details specified by the template file are required by Compaq's DSAs themselves. If you customize the template file, you need to avoid changing those details. If you create an entirely new template file, you need to incorporate these details in it.

The "Authenticated User" ACItem specifies that authenticated users can check the passwords of entries. This enables DSAs to check each other's passwords during normal operation. If you change this permission, DSAs might not be able to verify each other's identities, which can result in distributed operation failures. A DSA might reject a connection from another DSA, or decide not to attempt a connection to another DSA. This might prevent such routine activities as replication or the chaining of user requests.

The "Own entry" ACItem specifies that the directory user who owns an entry has all access to the `presentationAddress`, `protocolInformation`, and `supportedApplicationContext` attributes. If you change these permissions, Compaq's DSAs will not be able to manage their own entries, and might stop working. Do not change these details of the "Own entry" ACItem.

### **7.5.2 Access Controls Required by Directory Information Managers**

The access control template file includes some statements that are required by directory information managers. If you customize the template file, you need to avoid changing those details. If you create an entirely new template file, you need to incorporate these details in it.

The "Directory Managers" ACItem specifies that managers have full access to the `trustedDSAName` attribute. Do not change this permission. It is important for managers to be able to add and remove this attribute, to indicate whether a DSA is to be trusted by other DSAs.

Similarly, it is important that directory managers have full access to the `prescriptiveACI` attribute, so do not change that permission. If nobody has permission to manage the `prescriptiveACI` attribute, then once you have implemented access control, you may have to refer to *Compaq Enterprise Directory for eBusiness Problem Solving* for details of how to bypass access controls temporarily, to fix your access controls.

### **7.5.3 The Composition of Access Control Definitions**

All access controls are specified as values of the `prescriptiveACI` attribute. The `prescriptiveACI` attribute is a multivalued attribute. Each value is called an access control information item (ACItem).

Each ACItem states the following three sets of information:

- Who this ACItem applies to
- What directory information this ACItem applies to
- What types of request are to be granted and/or denied for those users with regard to that directory information

For example, an ACItem might state that a specific user is allowed to modify and read specific attributes, such as passwords.

The following sections discuss the three elements of an ACItem in more detail.

## Controlling Access to Your Directory Information and Services

### 7.5 Customizing Access Controls

#### 7.5.3.1 Specifying What Users an ACItem Applies To

This section is only required if you want to customize access controls.

When you specify an ACItem, you must specify to whom it applies. This can be done very specifically by means of a user's directory name. It can also be done less specifically, by reference to a directory subtree, to a `groupOfNames` entry, or by the use of two keywords: `OWNER` and `ALL`.

These options are known as ***user classes***, and they are documented in detail in Appendix B.

The significance of the user classes is that when a user connects to the Enterprise Directory, they have the option of identifying (authenticating) themselves. For example, when you use the DXIM windows utility, you use the Authenticate window to specify your name and password. When you use the DXIM command line utility you can specify your name and password in a BIND command. The Enterprise Directory can then check for the user's name in ACItems whenever they try to access directory information.

A user who does not authenticate themselves to the Enterprise Directory, is treated as an anonymous user. Typically, an anonymous user has fewer access rights than an authenticated user.

---

#### Note

---

When you authenticate yourself, the DSA to which you bind provides the relevant access to the information held by that DSA. However, if the DSA needs to communicate with another DSA to satisfy your requests, then the other DSA does not necessarily believe that you have been authenticated adequately. The other DSA only believes that you have been authenticated adequately if it trusts the DSA to which you are bound and authenticated directly. If this trust does not exist between the two DSAs, then the attempt to chain the user request will probably fail.

See Section 5.2.9 for full details of `decDSA` entries and DSA trust.

---

#### 7.5.3.2 Specifying What Information an ACItem Applies To

This section is only required if you want to customize access controls.

When you specify an ACItem, you must specify what directory information the ACItem applies to.

The set of options is as follows:

- You can control access to entries as a whole.  
Granting access to entries is a prerequisite for most other controls. For example, having access to particular attributes is useless unless you also have access to entries as a whole.
- You can control access to specific attributes.
- You can control access more generally to all ***user attributes***.

The schema makes a distinction between user attributes and ***operational attributes***. The access control syntax provides a means of indicating that an ACItem applies to all user attributes, such as common names, surnames, and telephone numbers.

- You can control access to specific operational attributes.



## Controlling Access to Your Directory Information and Services

### 7.5 Customizing Access Controls

Operational attributes are usually hidden from users. Typical examples are the `trustedDSAName` attribute which Compaq DSAs use to check each other's security status, and the `prescriptiveACI` attribute. Operational attributes are not displayed unless you request them explicitly.

You can specify a combination of these options in a single ACIitem. For example, you can specify a single ACIitem that applies to entries as a whole, and to specified attributes, and to specified operational attributes. These options are known as *item classes*, and they are documented in more detail in Appendix B.

#### 7.5.3.3 Specifying What Types of Request an ACIitem Applies To

This section is only required if you want to customize access controls.

When you specify an ACIitem, you must specify to what types of directory request the ACIitem applies. For example, you can specify that the ACIitem controls the use of the modify and delete services.

The definition of the different types of access to directory information is based on the X.500 services, such as search, modify, create and delete. However, the types of access are defined in more detail, such that you can give a user permission to search, but prohibit them from using a particular attribute in the search filter. Similarly, you can give a user permission to modify entries, but deny modifications to a particular attribute.

The different types of request for which access control can be defined are known as *permissions*, and they are documented in more detail in Appendix B.

#### 7.5.4 How ACIitems are Ranked According to Precedence and Specificity

An access control subentry may contain several ACIitems. The access control template file, for example, defines four ACIitems (see Section 7.4). For each user request for access to information, a DSA must decide which ACIitems are relevant. If multiple ACIitems appear to be relevant, the DSA must decide which ACIitem is the most important.

The DSA makes this decision based on the ACIitem precedence and how specific the ACIitem is about the operation that is being requested, and the user who is requesting it.

If you define ACIitems, you need to understand this decision making process so that you can assign the correct precedence to each ACIitem.

If a DSA finds that several ACIitems refer to a given access right for a given user, then the DSA only considers the ACIitem of the highest precedence. All other ACIitems are ignored for this request.

If the highest precedence value is shared by multiple relevant ACIitems, then the DSA has to examine those ACIitems and determine which is the most specific about the user and the user request. For example, an ACIitem that refers to "all attributes" is less specific than one that refers to a particular attribute or list of attributes. Similarly, an ACIitem that refers to "all users" is less specific than an ACIitem that refers to a particular user called John Smith.

The DSA determines which ACIitem is the most specific about the access rights and identity that are required for the operation that is being attempted, and applies that ACIitem.

*Compaq Enterprise Directory for eBusiness Problem Solving* provides further information about this topic, and describes how to analyze your access controls when they do not have the intended effect.

## 7.6 Access Control Scope and Inheritance

This section provides an overview of how a Compaq DSA applies access controls to portions of its database, and how access controls are inherited from one portion to another.

The basic rules of X.500 access control supported by Compaq's DSA are as follows:

- The unit of access control policy is the naming context.  
If you grant a user a certain level of access to a naming context, then they have that access to all entries in the naming context. Different users can have different levels of access to the same naming context.
- If there are no access controls stated in a naming context, then the naming context inherits the access controls from its directly superior naming context (if there is one).

If the directly superior naming context has no access controls, then the next most superior naming context's access controls apply. If none of the directly superior naming contexts have access controls (or there are no directly superior naming contexts), then the default access controls apply. By default, all users have all access to all information, except for user passwords, which are not readable.

---

**Note**

---

If you replicate a naming context that has inherited access controls, then those controls are also replicated, just as if the controls were part of the naming context.

If you replicate a naming context that has no access control and does not inherit any controls, then the shadow copy of the naming context may inherit the access controls of a superior naming context on the shadow DSA. This might mean that the same naming context can inherit different access controls on different shadow DSAs, and that the shadow copies do not have the same controls as the master copies.

To avoid having inconsistent access controls on different DSAs for the same information, Compaq recommends that you set up access control as described Section 7.3.

---

- Any naming context that has access control (that is, an `accessControlSubentry` entry with a `prescriptiveACI` attribute) enforces that access control. It is not affected by any access control from any other naming context, and it is not affected by the default access control.
- As soon as any access control is specified or inherited for a given naming context, then all access to that naming context is controlled by that access control, and no other. None of the default access controls apply any longer.  
If the specified or inherited access controls do not explicitly permit a particular type of access, then that type of access is denied. For example, if a naming context contains or inherits access controls that do not state that modifying information is allowed, then it is not allowed.

## Controlling Access to Your Directory Information and Services

### 7.6 Access Control Scope and Inheritance

For example, Figure 7–2 illustrates a DSA that holds four naming contexts. The presence of an `accessControlSubentry` entry in a given naming context is represented by an entry marked ACI.

Figure 7–2 Access Control in a DSA

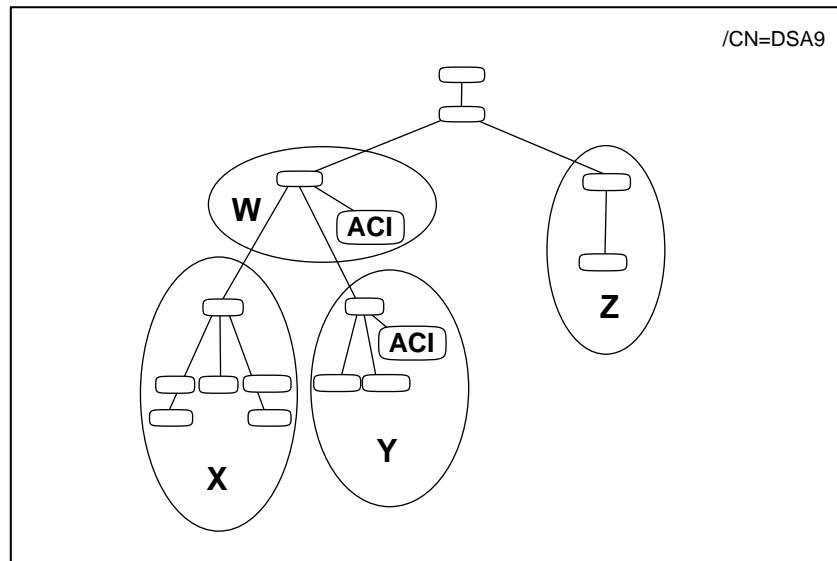

MIG0493

Naming Context W contains an `accessControlSubentry` entry with a `prescriptiveACI` attribute. Access to Naming Context W is defined by that entry.

Naming Context X does not contain an `accessControlSubentry` entry. However, it is directly subordinate to Naming Context W. It therefore inherits the access controls defined for Naming Context W.

Naming Context Y contains an `accessControlSubentry` entry. Access to Naming Context Y is defined by that entry. The fact that Naming Context Y is subordinate to Naming Context W has no effect on Naming Context Y because it has access controls of its own.

Naming Context Z does not contain an `accessControlSubentry` entry, and it is not subordinate to any naming context that does. Therefore, the DSA applies the default access controls to Naming Context Z.

---

#### Note

---

If Naming Context Z is a shadow copy of a naming context, then it may be controlled by access controls that are inherited on the supplier DSA and replicated to this DSA with Naming Context Z. In this case, the `accessControlSubentry` entry that controls Naming Context Z is actually superior to that naming context (not shown in Figure 7–2).

---

## Controlling Access to Your Directory Information and Services

### 7.7 Alternative Method of Controlling Access to DSAs

#### 7.7 Alternative Method of Controlling Access to DSAs

This section explains how to implement security for accessing DSAs if you decide not to follow the recommended method.

The recommended method involves using `decDSA` entries as described in Section 4.5, replicating them to all DSAs, as described in Section 5.1.5, and implementing access controls, as described in Section 7.1.

The advantages of implementing access controls as recommended are that:

- The recommended controls are replicated with the information, and therefore apply consistently to all copies the information.
- The recommended controls are far more flexible and detailed than the controls described in the following sections.
- The DSA applies the recommended controls to all users as soon as they are implemented, not just to new connections.
- The controls are not dependent on volatile configuration details.
- The recommended controls can provide different levels of access to different parts of the DIT, whereas the controls described in the following sections apply to all information in the relevant DSA.

It is also possible to implement a mixture of the recommended method and the methods described in the following sections. However, this makes diagnosing problems more difficult, as you need to understand how the various methods of control interact. It is therefore advisable to use only one method.

##### 7.7.1 Alternative Method of Configuring DSA Trust

To make a Compaq DSA trust another DSA, you can use the Trusted DSA Name characteristic attribute of the DSA entity. The attribute can contain a list of distinguished names (AE titles) of DSAs that are to be trusted by this DSA. For example, you could set the attribute as follows:

```
NCL> SET DSA TRUSTED DSA NAMES -  
_NCL> {"/c=us/o=abacus/cn=DSA1" , "/c=us/o=abacus/cn=DSA2"}
```

Each name listed in the Trusted DSA Names attribute must match the AE Title attribute of the relevant DSA.

The DSA trusts all DSAs whose distinguished names (AE titles) are listed in that attribute. The effect of this trust is that the DSA permits these trusted DSAs to access its information, and trusts these DSAs when they claim to be acting on behalf of authenticated users. This means that a user can authenticate themselves to one DSA, and have access to information on another DSA.

In order for the DSA to trust the named DSAs, those DSAs must specify their password when they bind to this DSA. This DSA checks the password, either by reference to the entry in the directory that represents the DSA (if there is such an entry), or by reference to an Accessor entity that has the DSA's name. For example, the following command creates an Accessor entity for a DSA:

```
NCL> CREATE DSA ACCESSOR "/C=US/O=Abacus/CN=DSA2"-  
_NCL> PASSWORD f1obadob
```

## Controlling Access to Your Directory Information and Services

### 7.7 Alternative Method of Controlling Access to DSAs

This Trusted DSA Name characteristic attribute serves the same purpose as the `trustedDSAName` attribute of `decDSA` entries. You are recommended to use the attribute of `decDSA` entries if possible. However, DSAs only refer to the `trustedDSAName` attributes of `decDSA` entries that they hold locally. That method therefore fails if you do not implement replication as discussed in Section 5.1.5. Not following the recommendation for replication is the most likely reason you would need to use this alternative method.

---

#### Note

---

A DSA only checks the value of the Trusted DSA Name attribute when it receives a new connection request. It either accepts or rejects the request accordingly. Any changes to the value of the Trusted DSA Name attribute have no effect on existing connections. You need to disable and re-enable the DSA to make sure that there are no existing connections benefitting from a level of access that you no longer want to provide.

---

#### 7.7.2 Alternative Method of Configuring User Security

If you do not want to implement access controls, as described in Section 7.1, or you want to override access controls for a specific DSA, you can use characteristic attributes of the DSA entity to specify the names of directory users who are allowed to access information. If you use either of these attributes, then any users who are not listed are not allowed access. This is therefore a very restrictive method of providing security, and probably not suitable for most DSAs.

This method is not recommended because it has to be managed manually and independently for each DSA, and because it does not provide the level of detail or flexibility that the recommended access controls provide.

The characteristic attributes only allow you to specify the names of users who can read directory information and/or users who can modify directory information. If you implement access controls as well as these attributes, then the characteristic attributes can override the access controls. For example, if you set up a list of users who are allowed to modify information, then any user who is not on that list is unable to modify information regardless of the permissions defined for them using ACIitems.

The following examples show how to configure these two attributes:

```
NCL> SET DSA WRITER NAMES -
_NCL> {"/c=us/o=abacus/ou=sales/cn=Jon Mole" , -
_NCL>  "/c=us/o=abacus/ou=sales/cn=Betty Hughes"}

NCL> SET DSA READER NAMES -
_NCL> {"/c=us/o=abacus/ou=sales/cn=Jan Thorp" , -
_NCL>  "/c=us/o=abacus/ou=sales/cn=Dave Hemmingly"}
```

The two users listed in the first command are allowed to modify information (for example, using `DXIM MODIFY`, `RENAME`, `CREATE`, `DELETE`, and `SET` commands), subject to the provision of a password and to the access controls defined for them using ACIitems. Other users are not allowed to modify information, regardless of any ACIitems defined for them. Being listed as a writer automatically enables these two users to read information as well, subject to any ACIitems. These two users are therefore implicit members of the reader list as well.

## Controlling Access to Your Directory Information and Services

### 7.7 Alternative Method of Controlling Access to DSAs

Similarly, the two users listed in the second command are allowed to read information on this DSA (for example, using DXIM SHOW, SEARCH, and COMPARE commands), subject to the provision of a password and to the access controls defined for them using ACIitems. These two users cannot modify information, regardless of any permissions specified for them in ACIitems. Their absence from the Writer Names attribute prevents them from modifying information. Other users are not allowed to read information (except for those listed as writers), regardless of any ACIitems defined for them.

Note that these attributes do not allow you to specify detailed access controls; they simply allow you to identify "readers" and "writers".

In order for the DSA to permit the named writers and readers the relevant access to information, the users must provide their name and password when they bind to the DSA. The DSA checks the password, either by reference to the entry in the directory that has the user's name, or by reference to an Accessor entity that has the user's name. For example, the following command creates an Accessor entity for Jon Mole:

```
NCL> CREATE DSA ACCESSOR "/C=US/O=Abacus/OU=Sales/CN=Jon Mole"-  
_NCL> PASSWORD flimflam
```

You need to use a similar command for every writer and reader who requires access to a given DSA, but who is not represented by a directory entry.

Note that the Accessor entity is specific to a single DSA. Such entities would have to be created manually on each DSA that uses this method of controlling access to DSAs. Furthermore, the Accessor entity is volatile information. When you use the NCL DELETE DSA command, all Accessor entities are lost, and must be reconfigured when you next start the DSA. If a user's password changes, then all Accessor entities that represent the user must be modified independently to reflect the change.

Note also that a DSA only checks these attributes and entities when it receives a new connection request. It either accepts or rejects a connection accordingly. Any changes to the configuration have no effect on existing connections. You need to disable and re-enable the DSA to make sure that there are no existing connections benefitting from a level of access that you no longer want to provide, or to make sure that a user gains the benefit of an increased level of access from reader to writer.

For further details about the Writer Names and Reader Names attributes, and the Accessor entity, refer to the online help for the Directory Module within the NCL director.

The management overhead of this method of controlling access to DSAs is considerably greater than the recommended method.

This method of controlling access might be suitable for DSAs that hold very sensitive information. You can ensure that only the named users have access. Note that these controls are DSA-specific, unlike the ACIitems described in Section 7.1.

This method might also be useful if you want to temporarily restrict access to a DSA, without having to amend the access controls implemented according to Compaq's advice.

## **Controlling Access to Your Directory Information and Services**

### **7.7 Alternative Method of Controlling Access to DSAs**

The configuration of these attributes on one DSA has no effect on access to any other DSA. A user might be able to read the sensitive information from some other DSA that holds a copy of it and does not have these characteristic attributes configured.





# Part III

---

## Set Up

This part describes how to set up your directory information and Enterprise Directory according to your plan.

- Chapter 8 describes how to configure a DSA to hold naming contexts and to replicate them to and from other DSAs.

This chapter is essential reading, although the sections about replication might not be relevant to all readers.

- Chapter 9 describes how to configure Compaq's directory applications so that they can connect to a DSA.

This chapter is essential reading unless you do not want to use Compaq's directory applications.

- Chapter 10 describes how to use Compaq's directory applications to create directory entries.

This chapter is not essential. Compaq's directory applications provide online help, which might be all you require. If you do not want to use Compaq's directory applications, then you need to refer to the documentation provided with your preferred application.

- Chapter 11 describes how to use the access control template file.

This chapter is only required if you want to control access to your directory information, and you want to use the template file rather than develop your own.



---

## Configuring DSAs

This chapter explains how to configure each of your DSAs. It assumes that you have completed the planning described in Part II.

Section 8.1 documents some important restrictions and recommendations that will help you when you configure your DSA.

Section 8.2 describes how to use the new DSA configuration utility to configure a presentation address and a temporary AE title for your DSA. You may have used the DSA configuration utility already as described in Section 5.2, because it is an easy way to generate presentation addresses you need for your worksheets. If so, you do not need to use the utility again.

Section 8.3 describes how to create a DSA and explains what happens during creation. Section 8.3.1 describes how to set the planned AE title for a DSA. The DSA configuration utility only sets a temporary AE title; you need to set the AE title as planned in Section 5.2.

Section 8.3.2 and Section 8.3.3 describe how to set a DSA's Password and the Volatile Modifications attributes, which are both recommended.

Section 8.3.4 describes how to set DSA Presentation Addresses. Section 8.3.5 describes the level of support for LDAP protocols, and how to set up the LDAP port.

Section 8.4 to Section 8.7 describe how to implement the planned DIT structure and distribution, and how to enable a DSA, and Section 8.8 shows how to create directory entries to represent your DSAs. The commands are documented in the order that you are most likely to use them the first time you configure a DSA. Section 8.9 provides a summary and example of these tasks. You will need your planning worksheets (see Chapter 5).

Section 8.10 explains how to implement replication. It also describes how you can customize replication, which was not supported in previous versions.

Section 8.11 and Section 8.12 describe how to disable and delete a DSA.

Section 8.13 explains how to automate the startup and shutdown of a DSA on OpenVMS systems.

## Configuring DSAs

### 8.1 Notes on Configuring a DSA

## 8.1 Notes on Configuring a DSA

The following sections explain some restrictions and requirements that you need to be aware of when you configure a DSA entity and its subtentities, such as Naming Context entities and Subordinate Reference entities.

### 8.1.1 Management Entities Must Be Created in Order of Superiority

When you configure a given DSA, you must create its Naming Context and Subordinate Reference entities in their order of superiority in the DIT (top down).

For example, a Naming Context or Subordinate Reference called /C=US/O=Abacus must be created before a Naming Context or Subordinate Reference called /C=US/O=Abacus/OU=Sales.

This restriction helps to prevent you from configuring your DSAs in ways that can cause problems during Enterprise Directory operation.

### 8.1.2 Configuring Entities of Different Types with the Same Name

If you need to create a Naming Context and a Subordinate Reference with the same name on the same DSA, you must create the Subordinate Reference first.

This situation applies to a DSA that is to hold contiguous master naming contexts, as shown in Figure 8-1.

Figure 8-1 Contiguous Naming Contexts

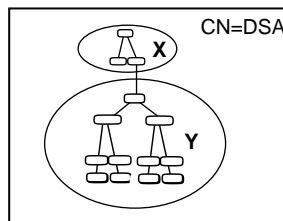

MIG0499

The DSA requires a subordinate reference to naming context Y, even though Y is to be held locally. The subordinate reference has the same name as the naming context to which it refers.

In such cases, you need to create the Subordinate Reference entity *before* you create the Naming Context entity of the same name. This restriction helps you to remember the requirement for the Subordinate Reference.

### 8.1.3 Configuring a DSA that Already Holds Information

If you configure a DSA in stages, adding new naming contexts at different times, you might find that you have created them in the wrong hierarchical order (see Section 8.1.1). Also, the presence of entities created automatically during replication prevents the creation of directly superior entities.

If a DSA already holds information subordinate to an entity you attempt to create, the DSA returns the following messages:

**REASON:** Has subordinates.

**Description:** The DSA already holds entries or entities subordinate to the entity being created

Refer to *Compaq Enterprise Directory for eBusiness Problem Solving* for details of how to identify the relevant subordinates, identify whether they are master or shadow information, and remove them so that you can create the entities you require above them. Alternatively, you might decide to create the new naming context on some other DSA, bypassing the problem.

Because of the inconvenience of having to remove existing information before creating superior information, it is highly advisable to implement your information in order of superiority, and to implement replication only after configuring as many DSAs as possible.

#### **8.1.4 Configuring a DSA Remotely**

In the following sections, it is assumed that you manage each DSA entity from an account on that entity's local system.

You can use NCL commands remotely. However, for most commands this requires proxy access to a privileged account on the remote system, or the specification of a name and password on each NCL command. See the NCL documentation for details of specifying management access controls in NCL commands if you want to manage entities remotely.

Also, if you want to use NCL on a system that does not run DECnet-Plus to manage a remote Compaq DSA, then you may need to use the following NCL command:

```
NCL> SET NCL TRANSPORT TCPIP
```

#### **8.1.5 DSA Configuration Details are Permanent**

The configuration tasks described in this chapter only need to be done once for each DSA. For example, a DSA's AE Title attribute needs to be configured when you first create a DSA, but only the first time. The DSA stores its configuration details in its database files, and configures itself every time you create it.

Once a DSA has been configured, the only commands that need to be repeated are CREATE DSA, ENABLE DSA, DISABLE DSA, and DELETE DSA. These are normally executed automatically during system startup and shutdown. The DSA installation procedure adds the DSA startup and shutdown procedures to the system procedures on Tru64 UNIX systems. Section 8.13 explains what you need to do to provide automatic startup and shutdown of DSAs on OpenVMS systems.

The only exception to this behaviour is the Accessor entity, which is not used for any of the configuration described in this chapter. The Accessor entity is deleted when you delete a DSA, and has to be manually recreated when you recreate the DSA, assuming you still need the entity.

#### **8.1.6 NCL Command Line Help is Available Online**

This chapter does not attempt to provide a full description of all NCL commands that you can use for the DSA. It concentrates on the commands you need to configure a typical Enterprise Directory.

If you want further details about any of the NCL commands used in this chapter, or about the other attributes of the DSA entities and subentities, or about the events and messages generated by the DSA, refer to the NCL online help. To access the Enterprise Directory help, use the following command:

```
NCL> HELP DIRECTORY_MODULE
```

## Configuring DSAs

### 8.1 Notes on Configuring a DSA

The help module for the Enterprise Directory provides full details of all entities, attributes, directives, events, and errors of the OpenVMS Enterprise Directory for eBusiness. *Compaq Enterprise Directory for eBusiness Problem Solving* also provides information about the NCL interface to the DSA, and explains how to respond to the various error messages.

### 8.2 Running the DSA Configuration Utility

This version of the Enterprise Directory provides a DSA configuration utility.

The main benefit of this utility is that it configures a DSA's presentation address, and sets the DSA's LDAP port number to 389, rather than requiring you to plan and configure this manually.

The utility also sets a temporary AE title for a DSA, but you need to replace this temporary value with the value you planned in Section 5.2. The temporary value enables you to start the DSA and experiment with it even before you have planned your final configuration properly.

If you have already used the DSA configuration utility, as described in Section 5.2.3, then there is no need to use it again.

Tru64  
UNIX

You need superuser privileges to run the configuration utility. To run the utility, type:

```
# /var/dxd/scripts/dsa_configure
```

◆

OpenVMS

You need SYSPRV and OPER privileges to run the configuration utility. To run the utility, type:

```
$ @SYS$STARTUP:DXD$DSA_CONFIGURE
```

◆

The utility only sets an AE title for your DSA if the DSA does not already have one. It never overwrites an existing AE title. If the DSA has no AE title, the utility sets one based on the name of the DSA system.

If your privileges are insufficient, the utility displays an error message and exits.

## 8.3 Creating DSAs

Create a DSA entity on each system that is to host a DSA.

```
NCL> CREATE DSA
```

If the command fails, see *Compaq Enterprise Directory for eBusiness Problem Solving*.

A created DSA can be configured, but needs to be enabled before it can receive connections from directory applications and other DSAs. Before you enable the DSA for the first time, you need to configure the planned AE Title and Password attributes. The DSA configuration utility (see Section 8.2) sets a temporary AE title which you need to replace with the planned value. You are also recommended to set the Volatile Modifications attribute to True. See Section 8.3.1, Section 8.3.2, and Section 8.3.3 for details.

Tru64  
UNIX

This version of the DSA uses memory image files rather than the snapshot files of previous versions. Memory image files provide superior startup and shutdown times, especially for very large databases. They are stored in /var/dxd.

Snapshot files are only supported for a small number of reasons:

- So that you can upgrade from a previous version.
- So that you can load a new schema file (see Chapter 6).
- So that you can defragment the memory image file (see Section 8.14).
- So that you can upgrade to a future version of the Enterprise Directory.

Different versions of the DSA may use different memory structures. A memory image file cannot, therefore, be supported through an upgrade.

For those occasions when you need snapshot files, the CREATE DSA and DELETE DSA commands support new options:

```
NCL> CREATE DSA FROM SNAPSHOT
```

```
NCL> DELETE DSA TO SNAPSHOT
```

If a given task requires a snapshot file, the documentation tells you what to do.

◆

### 8.3.1 Setting DSA AE Titles

This version provides a DSA configuration utility that sets an AE title for your DSA. However, the utility only sets a temporary AE title which you need to replace with the value that you planned to conform to your naming policy (see Section 4.5).

You do not need to set the planned AE title immediately. You can enable a DSA and experiment with it using the temporary AE title set by the DSA configuration utility. However, you need to set the planned AE titles before DSAs can interwork properly, for example, for replication.

## Configuring DSAs

### 8.3 Creating DSAs

The DSA must be in state OFF when you set its AE Title. The syntax is:

```
SET DSA AE TITLE "<AETitle>"
```

where <AETitle> is the AE Title for this DSA, specified in quotation marks.

For example:

```
NCL> SET DSA AE TITLE "/C=US/O=Abacus/CN=DSA1"
```

Remember that a DSA's AE Title is identical to the distinguished name of the decDSA entry that represents (or will represent) the DSA.

#### 8.3.2 Setting DSA Passwords

The DSA can be either ON or OFF when you set its Password. The syntax is:

```
SET DSA PASSWORD "password"
```

where `password` is the password of this DSA. The password can be up to 128 characters long, and is case-sensitive.

The value of the Password attribute of the DSA entity must match the value of the `userPassword` attribute of the decDSA entry that represents this DSA.

If the values do not match, then this DSA will not be able to prove its identity to other DSAs. This prevents replication, and restricts the distribution of user requests.

If you ever change a DSA's password, remember to configure that change using both NCL and the DXIM Set Password command, so that the value in the DSA's directory entry always matches the Password attribute of the DSA entity.

#### 8.3.3 Setting DSA Volatile Modifications

This is an optional DSA configuration task, but one that is recommended for performance reasons.

By default, a DSA always writes modifications to disk immediately, and delays sending a success response to the user until this has been done. This behaviour ensures that modifications are not lost in the event of an unexpected shutdown.

However, Compaq suggests that you configure the DSA to allow volatile modifications. This means that changes are written to disk after a delay of up to fifteen seconds. During this brief delay there is a possibility of an unexpected shutdown causing some loss of recent modifications. However, there is a significant performance advantage in allowing volatile modifications.

Unless your DSA has a strong requirement to guarantee no loss of modifications, Compaq recommends that you configure the DSA as follows:

```
ncl> SET DSA VOLATILE MODIFICATIONS TRUE
```

#### 8.3.4 Setting DSA Presentation Addresses

DSA presentation addresses are most easily configured using the DSA configuration utility (see Section 8.2). There should never be any need to configure them manually. However, it is possible to use NCL to set a DSA's presentation address, using the following syntax:

```
SET DSA PRESENTATION ADDRESS '<paddr>'
```



where <addr> is the presentation address for this DSA, specified in single quotation marks. For example:

```
NCL> SET DSA PRESENTATION ADDRESS '"DSA"/"DSA"/"DSA"/NS+49200190400012,CLNS'
```

The DSA must be in state OFF when you set its Presentation Address.

If a DSA has multiple network addresses, for example for RFC1006, X.25, and CLNS, separate each network address with the | character, for example:

```
NCL> SET DSA PRESENTATION ADDRESS '"DSA"/"DSA"/"DSA"/NS+490011AA0000021,CLNS|NS+37102251220021,CONS|RFC1006+11.22.33.44,RFC1006'
```

Do not attempt to break a presentation address across multiple command lines; simply wrap the address as shown, or use a wider terminal window.

Note that the display conventions that NCL uses for presentation addresses are not the same as the input conventions, and are not consistent across all platforms. If you want to cut and paste an address from a display into a command, be careful to select only the address itself, and to enclose the address in single quotes. NCL supports the use of single quotes in commands, as shown in the example above, consistently on all platforms.

### 8.3.5 Setting DSA LDAP Port

The X.500 DSA supports both the LDAP V2 and V3 protocols. This allows LDAP clients to access the X.500 directory.

The Enterprise Directory listens for LDAP requests on that port when the DSA is enabled. The following command is used to set up an LDAP port:

```
NCL> SET DSA LDAP PORT 389
```

## 8.4 Creating a Naming Context Entity

A DSA can be either ON or OFF when you create a Naming Context entity. Remember that you must only create Naming Context entities for the naming contexts for which the DSA is the master DSA. Any naming contexts that are to be held as replicated copies are represented by entities that are created automatically during replication.

The syntax is:

```
CREATE DSA NAMING CONTEXT "<distinguished-name>"
```

where <distinguished-name> is the name of a naming context, in quotation marks. For example:

```
NCL> CREATE DSA NAMING CONTEXT "/C=US/O=Abacus"
```

Refer to the DSA worksheet to find out what naming contexts to specify for a given DSA. Remember that you must create subentities of the DSA in their order of hierarchical superiority (see Section 8.1).

If the command fails, see *Compaq Enterprise Directory for eBusiness Problem Solving*.

## Configuring DSAs

### 8.4 Creating a Naming Context Entity

#### 8.4.1 Configuring Consumer Access Points on Naming Contexts

It is possible to specify the Consumer Access Point attribute in a CREATE DSA NAMING CONTEXT command, to indicate which DSAs are primary consumers of a naming context. However, it is advisable to wait until the relevant consumer DSAs are actually ready to respond to replication requests. This prevents the supplier DSA from attempting to supply information before the consumers are ready to receive it.

If you want to specify the attribute in the CREATE command, the syntax is as follows:

```
CREATE DSA NAMING CONTEXT "<distinguished_name>" -  
  CONSUMER ACCESS POINT -  
  {[AE TITLE = "<AETitle>", PRESENTATION ADDRESS = '<paddr>']}
```

where <distinguished-name> is the name of a naming context in quotation marks, <AETitle> is the AE title of a consumer DSA in quotation marks, and <paddr> is a presentation address of a consumer DSA in single quotation marks.

If the Naming Context is to be supplied to more than one primary consumer DSA, details of each consumer can be specified, as follows:

```
CREATE DSA NAMING CONTEXT "<distinguished_name>" -  
  CONSUMER ACCESS POINT -  
  {[AE TITLE = "<AETitle>", PRESENTATION ADDRESS = '<paddr>'}, -  
  [AE TITLE = "<AETitle>", PRESENTATION ADDRESS = '<paddr>']}]
```

The {} characters enclose a comma separated list, with each access point enclosed by [] characters.

If you do not specify the Consumer Access Point on the CREATE command, then you use the SET DSA NAMING CONTEXT command when you are ready to implement replication, as shown in Section 8.10. Section 8.10 also shows an example of how to implement secondary shadowing, which always requires the use of the SET command, because shadow naming contexts are never created manually.

## 8.5 Creating a Subordinate Reference Entity

To create a Subordinate Reference entity, use the following command syntax.

```
CREATE DSA SUBORDINATE REFERENCE "<distinguished-name>" -  
  ACCESS POINT -  
  {[AE TITLE = "<AETitle>", PRESENTATION ADDRESS = '<paddr>'}], -  
  COPY ACCESS POINT -  
  {[AE TITLE = "<AETitle>", PRESENTATION ADDRESS = '<paddr>']}
```

where <distinguished-name> is the name of a subordinate naming context in quotation marks, <AETitle> is an application entity title in quotation marks of a DSA that holds the naming context, and <paddr> is the presentation address of a DSA that holds the naming context.

For example, the following command sets up a Subordinate Reference entity that provides a reference to the naming context called /C=US/O=Abacus/OU=Sales:

```
_NCL> CREATE DSA SUBORDINATE REFERENCE "/C=US/O=Abacus/OU=Sales" -  
_NCL> ACCESS POINT -  
_NCL> {[AE TITLE = "/C=US/O=Abacus/CN=DSA2", -  
_NCL>   PRES ADDRESS="/DSA"/"DSA"/"DSA"/NS+49AA001992AAA0000000,CLNS'}], -  
_NCL> COPY ACCESS POINT -  
_NCL> {[AE TITLE = "/C=US/O=Abacus/CN=DSA4", -  
_NCL>   PRES ADDRESS="/DSA"/"DSA"/"DSA"/NS+49AA001992AA900000000,CLNS'}}
```

## Configuring DSAs

### 8.5 Creating a Subordinate Reference Entity

The keywords `PRESENTATION ADDRESS` are abbreviated in this example, to save space.

The Access Point attribute contains information about the master DSA of the naming context for which this is a reference. The Copy Access Point attribute contains information about a shadow DSA for the subordinate naming context.

If you want to specify more than one Copy Access Point, because you know of more than one shadow DSA for the subordinate naming context, use the following syntax:

```
CREATE DSA SUBORDINATE REFERENCE "<distinguished-name>" -
ACCESS POINT -
  {[AE TITLE = "<AETitle>", PRESENTATION ADDRESS = '<paddr>'], -
COPY ACCESS POINT -
  {[AE TITLE = "<AETitle>", PRESENTATION ADDRESS = '<paddr>'], -
  [AE TITLE = "<AETitle>", PRESENTATION ADDRESS = '<paddr>'], -
  [AE TITLE = "<AETitle>", PRESENTATION ADDRESS = '<paddr>']}
```

You need to specify at least one attribute for each subordinate reference, although it can be either an Access Point attribute or a Copy Access Point attribute.

Refer to the worksheet to find out what Subordinate Reference entities to create for a given DSA, and what presentation addresses and AE titles to specify for the attributes.

If the command fails, see *Compaq Enterprise Directory for eBusiness Problem Solving*.

You can use the `NCL SET`, `ADD`, `REMOVE`, and `SHOW` directives to manage the access point information for the Subordinate Reference entity. For example, if a Subordinate Reference entity has a Copy Access Point attribute that contains an incomplete list of DSAs that hold copies of the naming context, you can use the `ADD` command to add further access points. Similarly, you can use the `REMOVE` command to remove access points from the list.

### 8.6 Creating a Superior Reference Entity

To create a Superior Reference entity, use the following command syntax:

```
CREATE DSA SUPERIOR REFERENCE -
ACCESS POINT -
  {[AE TITLE = "<AETitle>", -
PRESENTATION ADDRESS = '<paddr>']}
```

where `<AETitle>` is an application entity title, and `<paddr>` is a presentation address of a superior DSA.

For example, the following command sets up a superior reference for a DSA to a superior DSA called `"/C=US/CN=National DSA"`:

```
NCL> CREATE DSA SUPERIOR REFERENCE -
_NCL> ACCESS POINT -
_NCL> {[AE TITLE = "/C=US/CN=National DSA", -
_NCL> PRESENTATION ADDRESS = '"DSA"/"DSA"/"DSA"/NS+12341234123414,CLNS']}
```

You only specify details of one superior DSA; multiple access points are not permitted. The superior DSA can be either a master DSA or a shadow DSA.

Refer to your worksheet DSA to find out what Superior Reference entity, if any, a given DSA requires.

If the command fails, see *Compaq Enterprise Directory for eBusiness Problem Solving*.

## Configuring DSAs

### 8.7 Enabling DSAs

## 8.7 Enabling DSAs

The ENABLE DSA directive puts a DSA into state ENABLING. When the DSA has finished enabling, it goes into state ON. You cannot enable a DSA unless the AE Title and Presentation Address attributes are configured.

The command syntax is:

```
NCL> ENABLE DSA
```

When in state ON, a DSA can receive connections from directory applications and other DSAs. For example, you can use DXIM to bind to the DSA and create and display directory entries. In state ON, the DSA can also receive replication requests from other DSAs.

If the command fails, see *Compaq Enterprise Directory for eBusiness Problem Solving*.

## 8.8 Creating Directory Entries to Represent Your DSAs

When you have configured the DSA that holds your organization's highest naming context, you can create the directory entries that represent your DSAs. If you follow Compaq's recommendations, these entries are part of your highest naming context.

The DSA entries were planned in Section 4.5 and the DXIM commands that you use to create them were planned in Section 5.2.9.1. You can now create those entries, although you need to create their parent entry as well. For example:

1. Configure application defaults on the system that runs the DSA that holds your highest naming context.

Section 9.1 describes the DUA configuration utility.

2. Invoke the DXIM command line utility, as follows:

```
Tru64
UNIX    $ dxim -c
        ◆
```

```
OpenVMS $ DXIM /INTERFACE=CHARACTER_CELL
        ◆
```

3. Create the entry at the top of the highest naming context. For example, the Abacus directory manager types:

```
dxim> create /C=US/O=Abacus attributes objectClass=Organization
```

4. Create the entries to represent your DSAs. For example, the Abacus manager uses the following command to create the entry for CN=DSA1.

```
dxim> create /C=US/O=Abacus/CN=DSA1 -
_dxim> attributes -
_dxim> objectClass=(decDSA,DSA,applicationEntity), -
_dxim> trustedDSAName="/C=US/O=Abacus/CN=DSA1", -
_dxim> userPassword=unguessable-textstring, -
_dxim> presentationAddress="'DSA"/"DSA"/"DSA"/NS+49004005002B0AEBDB21,CLNS'
```

Use a sequence of DXIM commands like this to create entries to represent each of your Compaq DSAs. Remember that the `userPassword` attribute is case sensitive, so you need to specify the same case as you used in `NCL SET DSA PASSWORD` command.

## Configuring DSAs

### 8.8 Creating Directory Entries to Represent Your DSAs

If one or more of the DSA entries already exist, this is because Compaq DSAs attempt to create them automatically. This is not a problem.

## 8.9 Summary of Configuration

When you have created all of the Naming Context entities and Subordinate References for a DSA, then the DSA is ready to be populated. Section 8.8 shows how to begin populating your highest naming context to create the entries to represent your DSAs.

It is possible to configure and populate one naming context at a time, if you prefer. It is not advisable to populate a naming context before configuring the subordinate references related to that naming context.

The commands described in Sections 8.3 to 8.7 provide a distributed Enterprise Directory. Note that consumer information has not yet been configured, so replication is not yet implemented.

Also, only your equivalent of `CN=DSA1` has a full set of knowledge about naming contexts held by other DSAs. The other DSAs are going to get these references automatically when they consume copies of the Naming Context called `/C=US/O=Abacus`. Section 8.10 explains how to implement replication.

If you do not want to implement replication, then the alternative solution is to give each DSA a Superior Reference entity that identifies your equivalent of `CN=DSA1`. However, that solution greatly increases the workload of `CN=DSA1`, and if that DSA is unavailable for any reason, the usefulness of your whole Enterprise Directory is greatly reduced. By implementing replication as recommended, the workload of your Directory Service is shared by your DSAs, and performance is improved.

The example in Section 8.9.1 shows how the worksheet for `CN=DSA1` (see Chapter 5) translates into a sequence of configuration commands.

### 8.9.1 Examples of Configuring DSAs

This section shows how the worksheets for `CN=DSA1` (see Chapter 5) translates into a sequence of configuration commands.

The completed worksheet for `CN=DSA1` is shown in Figure 8–2.

## Configuring DSAs

### 8.9 Summary of Configuration

Figure 8–2 Worksheet for CN=DSA1

```
Worksheet for CN=DSA1
AE Title = "/C=US/O=Abacus/CN=DSA1"
Password = unguessable-textstring
Pres Addr = "DSA"/"DSA"/"DSA"/NS+49004005002B0AEBDB21,CLNS'
LDAP Port = 389

Naming Contexts
(A) /c=us/o=abacus (master)
    consumer AE Title = "/C=US/O=Abacus/CN=DSA2"
              Pres Addr = "DSA"/"DSA"/"DSA"/NS+49aa001992aaa0000000,CLNS'
    consumer AE Title = "/C=US/O=Abacus/CN=DSA3"
              Pres Addr = "DSA"/"DSA"/"DSA"/NS+49aa001992aa20000000,CLNS'
    consumer AE Title = "/C=US/O=Abacus/CN=DSA4"
              Pres Addr = "DSA"/"DSA"/"DSA"/NS+49aa001992aa90000000,CLNS'

Subordinate References
(B) /C=US/O=Abacus/OU=Sales
    master AE Title = "/C=US/O=Abacus/CN=DSA2"
           Pres Addr = "DSA"/"DSA"/"DSA"/NS+49aa001992aaa0000000,CLNS'
    copy  AE Title = "/C=US/O=Abacus/CN=DSA4"
           Pres Addr = "DSA"/"DSA"/"DSA"/NS+49aa001992aa90000000,CLNS'

(C) /C=US/O=Abacus/OU=Research
    master AE Title = "/C=US/O=Abacus/CN=DSA6"
           Pres Addr = "DSA"/"DSA"/"DSA"/NS+49aa001992aa22000000,CLNS'
    copy  AE Title = "/C=US/O=Abacus/CN=DSA2"
           Pres Addr = "DSA"/"DSA"/"DSA"/NS+49aa001992aaa0000000,CLNS'
    copy  AE Title = "/C=US/O=Abacus/CN=DSA4"
           Pres Addr = "DSA"/"DSA"/"DSA"/NS+49aa001992aa90000000,CLNS'

(D) /C=US/O=Abacus/OU=Personnel
    master AE Title = "/C=US/O=Abacus/CN=DSA5"
           Pres Addr = "DSA"/"DSA"/"DSA"/NS+49aa001992aa30000000,CLNS'
    copy  AE Title = "/C=US/O=Abacus/CN=DSA6"
           Pres Addr = "DSA"/"DSA"/"DSA"/NS+49aa001992aa22000000,CLNS'
```

MIG0276

This DSA will be the master DSA for the highest naming context in the Abacus DIT. It will supply copies of that naming context to three other DSAs. However, consumer details will not be specified yet (see Section 8.10).

The DSA will have three subordinate references. Each of these includes details of the master DSA and all shadow DSAs for the three subordinate naming contexts.

The following sequence of NCL commands configures the DSA to implement these plans.

## Configuring DSAs 8.9 Summary of Configuration

```
NCL> CREATE DSA
NCL> SET DSA AE TITLE "/C=US/O=Abacus/CN=DSA1"
NCL> SET DSA PRESENTATION ADDRESS -
_NCL> ' "DSA"/"DSA"/"DSA"/NS+49004005002B0AEBDB21,CLNS'
NCL> SET DSA LDAP PORT 389
NCL> SET DSA PASSWORD "unguessable-textstring"
NCL> CREATE DSA NAMING CONTEXT "/C=US/O=Abacus"
NCL> CREATE DSA SUBORDINATE REFERENCE "/C=US/O=Abacus/OU=Sales" -
_NCL> ACCESS POINT -
_NCL>   {[AE TITLE="/C=US/O=Abacus/CN=DSA2", -
_NCL>     PRES ADDRESS=' "DSA"/"DSA"/"DSA"/NS+49AA001992AAA0000000,CLNS' ], -
_NCL>   [AE TITLE="/C=US/O=Abacus/CN=DSA4", -
_NCL>     PRES ADDRESS=' "DSA"/"DSA"/"DSA"/NS+49AA001992AA900000000,CLNS' ]}
NCL> CREATE DSA SUBORDINATE REFERENCE "/C=US/O=Abacus/OU=Research" -
_NCL> ACCESS POINT -
_NCL>   {[AE TITLE="/C=US/O=Abacus/CN=DSA6", -
_NCL>     PRES ADDRESS=' "DSA"/"DSA"/"DSA"/NS+49AA001992AA220000000,CLNS' ]} -
_NCL> COPY ACCESS POINT -
_NCL>   {[AE TITLE="/C=US/O=Abacus/CN=DSA2", -
_NCL>     PRES ADDRESS=' "DSA"/"DSA"/"DSA"/NS+49AA001992AAA00000000,CLNS' ], -
_NCL>   [AE TITLE="/C=US/O=Abacus/CN=DSA4", -
_NCL>     PRES ADDRESS=' "DSA"/"DSA"/"DSA"/NS+49AA001992AA900000000,CLNS' ]}
NCL> CREATE DSA SUBORDINATE REFERENCE "/C=US/O=Abacus/OU=Personnel" -
_NCL> ACCESS POINT -
_NCL>   {[AE TITLE="/C=US/O=Abacus/CN=DSA5", -
_NCL>     PRES ADDRESS=' "DSA"/"DSA"/"DSA"/NS+49AA001992AA300000000,CLNS' ]} -
_NCL> COPY ACCESS POINT -
_NCL>   {[AE TITLE="/C=US/O=Abacus/CN=DSA6", -
_NCL>     PRES ADDRESS=' "DSA"/"DSA"/"DSA"/NS+49AA001992AA220000000,CLNS' ]} -
```

The above commands provide CN=DSA1 with all of its knowledge information configuration. CN=DSA1 can now be enabled, as follows:

```
NCL> ENABLE DSA
```

DXIM can then bind to CN=DSA1, and populate the naming context for which it is the master DSA. See Chapter 9 for details of configuring DXIM to bind to a DSA automatically.

When you populate your equivalent of the /C=US/O=Abacus naming context, remember to create decDSA entries, as described in Section 8.8.

## 8.10 Implementing Replication

This section describes how to implement replication for a typical Enterprise Directory. Note that replication cannot be guaranteed to succeed between DSAs with different schema. If you have customized the schema of any DSA, check that the same customizations have been applied to all DSAs (see Chapter 6).

Figure 8-3 shows the planned replication between the six DSAs in the example Enterprise Directory discussed in Chapter 5.

## Configuring DSAs

### 8.10 Implementing Replication

Figure 8–3 Planned Replication of Naming Contexts

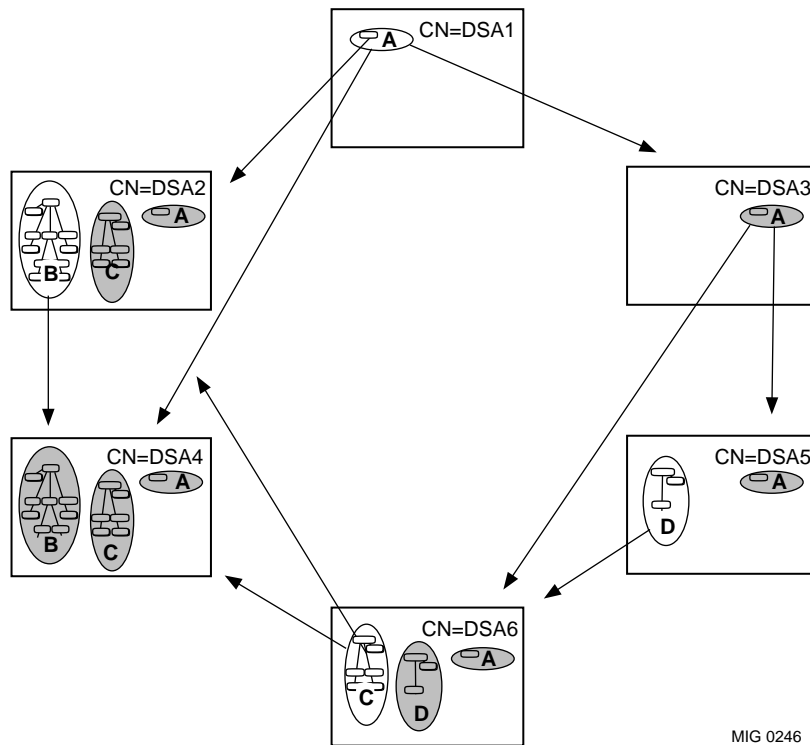

MIG 0246

The plan includes examples of primary and secondary shadowing.

When this plan is fully implemented, the following will all be true:

- Each DSA will be configured with details of the DSAs that are to consume each of its naming contexts.
- Each DSA will be able to verify the password of every other DSA in the example service.

This is because each DSA will hold a local copy of the naming context that contains the `decDSA` entries.

Compaq recommends that the simplest way to reach that final state is to implement all of the replication plans for your equivalent of Naming Context A first. Naming Context A contains the entries that represent your DSAs. As soon each DSA receives a copy of that naming context, it can verify the identities of all other DSAs, making further replication plans much easier to implement. This is one of the reasons why that naming context is replicated to all DSAs.

For the example shown in Figure 8–3, the simplest sequence of tasks is as follows:

1. Use NCL on `CN=DSA1` to add the Consumer Access Point attribute to Naming Context A (`/C=US/O=Abacus`), as follows:



## Configuring DSAs

### 8.10 Implementing Replication

```
NCL> SET DSA NAMING CONTEXT "/C=US/O=Abacus" -
_NCL> CONSUMER ACCESS POINT -
_NCL> {[AE TITLE="/C=US/O=Abacus/CN=DSA2", -
_NCL> PRES ADDRESS="/DSA"/"DSA"/"DSA"/NS+49aa001992a00000000,CLNS']} -
_NCL> [AE TITLE="/C=US/O=Abacus/CN=DSA3", -
_NCL> PRES ADDRESS="/DSA"/"DSA"/"DSA"/NS+49aa001992aa20000000,CLNS']} -
_NCL> [AE TITLE="/C=US/O=Abacus/CN=DSA4", -
_NCL> PRES ADDRESS="/DSA"/"DSA"/"DSA"/NS+49aa001992aa90000000,CLNS']}]
```

The keywords **PRESENTATION ADDRESS** are abbreviated in these examples.

**CN=DSA1** reacts to this command by trying to communicate with each of the three listed consumer DSAs. However, this fails because those three DSAs cannot yet verify **CN=DSA1**'s password. (They could refer to **CN=DSA1** to verify the password, but clearly that would be a security risk).

2. Use the following **UPDATE DSA** directive on **CN=DSA2** (which must be in state **ON**):

```
NCL> UPDATE DSA SUPPLIER "/DSA"/"DSA"/"DSA"/NS+49004005002B0AEBDB21,CLNS'
```

where the specified presentation address is that of **CN=DSA1**.

The command creates a connection to **CN=DSA1**, and causes a **shadowing agreement** to be created between this DSA and **CN=DSA1**. Replication happens automatically almost immediately afterwards. See Section 8.10.1 for some important notes about shadowing agreements.

3. Repeat step 2 for each of **CN=DSA3** and **CN=DSA4**.

When these tasks are completed, **CN=DSA1**, **CN=DSA2**, **CN=DSA3**, and **CN=DSA4** will all have local access to the **decDSA** entries. This means that further replications between them do not require you to use the **UPDATE DSA** directive as shown in step 3. Each of the three consumer DSAs will periodically connect to **CN=DSA1** to ask for any updates to the replicated naming context.

This has implemented the primary shadowing of Naming Context A to three consumers, as shown in Figure 8-3.

**CN=DSA5** and **CN=DSA6** are to use secondary shadowing to replicate copies of the **/C=US/O=Abacus** naming context from **CN=DSA4**.

4. Add a Consumer Access Point attribute to the shadow naming context on **CN=DSA4**:

```
NCL> SET DSA NAMING CONTEXT "/C=US/O=Abacus" -
_NCL> CONSUMER ACCESS POINT -
_NCL> {[AE TITLE = "/C=US/O=Abacus/CN=DSA5", -
_NCL> PRES ADDR "/DSA"/"DSA"/"DSA"/NS+49aa001992aa30000000,CLNS']} -
_NCL> {[AE TITLE = "/C=US/O=Abacus/CN=DSA6", -
_NCL> PRES ADDR "/DSA"/"DSA"/"DSA"/NS+49aa001992aa22000000,CLNS']}]
```

5. Use the following **UPDATE DSA** directive on **CN=DSA5** (which must be in state **ON**):

```
NCL> UPDATE DSA SUPPLIER "/DSA"/"DSA"/"DSA"/NS+49aa001992aa90000000,CLNS'
```

where the specified presentation address is that of **CN=DSA4**.

The command creates a connection to **CN=DSA4**, and causes a **shadowing agreement** to be created between this DSA and **CN=DSA4**. Replication happens automatically almost immediately afterwards.

6. Repeat step 5 for **CN=DSA6**.

## Configuring DSAs

### 8.10 Implementing Replication

Replication of Naming Context A is now complete for all DSAs in the example Enterprise Directory. This means that all six DSAs can verify each other's passwords, because they all hold copies of the `decDSA` entries.

All remaining replication can be implemented simply by adding the relevant Consumer Access Point attributes to Naming Contexts. Now that the DSAs can verify each other's passwords, there is no need to use the UPDATE DSA directive to make DSAs replicate.

For example, to implement the replication plans for Naming Context B in Figure 8-3, use NCL on `CN=DSA2` to add a Consumer Access Point attribute with details of the planned consumer: `CN=DSA4`. When you add this attribute, `CN=DSA2` automatically connects to `CN=DSA4` and replication takes place almost immediately afterwards. There is no need to use the UPDATE DSA command on `CN=DSA4`.

---

#### Note

---

Once replication is established, consumer DSAs and supplier DSAs communicate periodically (every 12 hours by default) to make sure the shadow copies are kept up to date.

The UPDATE DSA command is used only for the following reasons:

- To implement replication for the first time, when DSAs cannot verify each other's identities.
  - To help solve certain problem situations, as described in *Compaq Enterprise Directory for eBusiness Problem Solving*
- 

#### 8.10.1 Managing Shadowing Agreement Subentries

This section describes how to customize some aspects of replication. There is no need to read this section if you are satisfied with the default behaviour of replication.

Every shadowing agreement between a pair of DSAs is represented by two **subentries**; one held by the supplier DSA, and the other by the consumer DSA. Subentries are a special class of entry that represent aspects of Enterprise Directory configuration, and that are normally hidden from users.

In the case of shadowing agreement subentries, the configuration information in a given subentry is specific to the DSA that holds it. The two subentries relating to a shadowing agreement between two DSAs are not identical. For example, the one held by the supplier identifies the consumer DSA, and indicates that this is the supplier's part of the agreement, while the one held by the consumer identifies the supplier, and indicates that this is the consumer's part of the agreement. The two subentries are not, therefore, copies of each other. They are an example of **DSA specific subentries**, that is, they represent configuration information that is specific to the DSA that holds them.

Because the information in these subentries is relevant to only one DSA, these subentries are not replicated like normal entries, and other DSAs have no knowledge that the subentries exist. In order to manage a shadowing agreement subentry, it is therefore necessary to bind directly to the DSA that holds it. This is explained in more detail for those tasks that involve management of the subentries.

Each pair of shadowing agreement subentries defines the style and frequency of replication for the naming context to which they apply. The supplier DSA creates a default shadowing agreement subentry automatically soon after you configure the Consumer Access Point attribute of a Naming Context entity. The supplier DSA instructs the consumer DSA to create a corresponding subentry just before replication takes place for the first time. The subentries are, therefore, always created automatically. The only reason why you might ever need to create a shadowing agreement subentry manually is if you are trying to configure replication between a Compaq DSA and another vendor's DSA.

Default shadowing agreements specify that the consumer DSA initiates replication for a given naming context at twelve hour intervals, and that only the entries that have changed since the last successful replication are replicated (as opposed to replicating the entire naming context every time).

The two types of amendment to these defaults that you can consider are:

- To amend the frequency and specific schedule of replication attempts
- To amend the style of replication, such that replication happens as soon as changes occur, rather than after scheduled intervals

One additional management control is the ability to force an immediate replication attempt, rather than wait for the next scheduled attempt.

The following sections describe how to implement these options, if you consider them preferable to the defaults.

*There is no requirement to manage these subentries manually.* The defaults are designed to give efficient replication that should suit most customers. Certainly, you should never delete a shadowing agreement subentry manually.

#### 8.10.1.1 Notes About Modifying Shadowing Agreement Subentries

Any amendments you make to an agreement apply only to that agreement. This means that, for example, you can configure different replication schedules for different agreements.

If you implement secondary shadowing for a given naming context, you might consider coordinating the replication schedules of the primary and secondary agreements. For example, you might arrange secondary replication to occur shortly after the relevant primary replication should have completed.

If a shadowing agreement is deleted for any reason, and then recreated by the DSA, the new shadowing agreement may be a default agreement, and any modifications you made to the schedule or the style of replication may need to be implemented again. For example, if the Consumer Access Point is deleted, the relevant shadowing agreement subentries are deleted. If the Consumer Access Point is added again, a new, default agreement is created.

#### 8.10.1.2 Identifying the Subentries for a Given Shadowing Agreement

If you want to display and manage shadowing agreement subentries, you first need to find them in the directory. Each agreement is actually represented by two shadowing agreement subentries; one held by the supplier and one held by the consumer.

---

#### Note

The agreement subentries held by the consumer DSA and supplier DSA are slightly different from each other, and are not replicated along with the other entries held in a naming context.

## Configuring DSAs

### 8.10 Implementing Replication

The consumer DSA does not hold a shadow copy of the subentry, as you might expect, but holds a slightly different subentry that represents its view of the agreement.

When modifying agreements, it is important to know whether you need to modify the subentry held by the consumer or the supplier, and to be able to tell the difference between the two.

---

The agreement subentries pertaining to a given naming context are created immediately beneath the highest entry in the naming context. If a given naming context is replicated to several DSAs, there will be several agreement subentries. You need to identify the subentries that represent the particular agreement you want to modify.

Shadowing agreement subentries have a naming convention that helps you identify which ones apply to which agreement. For example, suppose that you want to identify the subentries that represent an agreement between DSA1 and DSA2 for the naming context called /C=US/O=Abacus, for which DSA1 is the consumer DSA, and DSA2 is the supplier.

To identify the consumer's subentry, bind directly to the consumer DSA, DSA1, and use the DXIM SEARCH SUBORDINATES command, as follows:

```
dxim> search subordinates /C=US/O=Abacus -
_dxim> where objectClass=shadowingAgreement subentries local scope
```

The SEARCH SUBORDINATES command should cause one or more subentry names to be listed, including the following:

```
/C=US/O=Abacus/CN="Consumer /C=US/O=Abacus/CN=DSA2 1"
```

The common name of the subentry confirms that it is the agreement held by the consumer DSA, and that the other DSA supporting this agreement is DSA2.

If you bind directly to the supplier DSA and do the same search command, you should see a list of names including the following:

```
/C=US/O=Abacus/CN="Supplier /C=US/O=Abacus/CN=DSA1 1"
```

There may be several agreements whose common names include the word "Supplier", but only one that also includes the name /C=US/O=Abacus/CN=DSA1. DSA2 may supply the naming context to several consumers, but only one of its agreement subentries relates to the agreement with DSA1.

The next task is to identify which of the two DSAs is the **initiator** of replication. This is explained in Section 8.10.1.3.

#### 8.10.1.3 Identifying the Initiator of Replication

Having identified the two subentries that represent the two halves of the agreement you want to modify (see Section 8.10.1.2), you need to identify which of the two DSAs is the **initiator** of replication for this agreement.

By default, the consumer DSA is the initiator of replication, but it is advisable to confirm this before attempting to modify the agreement.

To confirm that the consumer DSA is the initiator of replication, bind directly to the consumer DSA (DSA1), and show the shadowingFlags attribute of the shadowing agreement subentry. For example:

## Configuring DSAs

### 8.10 Implementing Replication

```
dxim> show /C=US/O=Abacus/CN="Consumer /C=US/O=Abacus/CN=DSA2 1" -
_dxim> attribute shadowingFlags local scope

/C=US/O=Abacus/CN="Consumer /C=US/O=Abacus/CN=DSA2 1"
shadowingFlags = UseDOP+ConsumerInitiated+OtherTimes
```

You can also confirm that the consumer DSA is the initiator of replication by binding to the supplier DSA, and showing the `shadowingFlags` attribute of its shadowing agreement subentry. For example:

```
dxim> show /C=US/O=Abacus/CN="Supplier /C=US/O=Abacus/CN=DSA1 1" -
_dxim> attribute shadowingFlags local scope

/C=US/O=Abacus/CN="Supplier /C=US/O=Abacus/CN=DSA1 1"
shadowingFlags = IsSupplier+UseDOP+ConsumerInitiated+OtherTimes
```

In both cases, the `shadowingFlags` attribute confirms that the agreement is consumer initiated. If the agreements do not include the `ConsumerInitiated` flag, then they have already been modified by someone. In this case, the agreements should have one of the `SupplierInitiated` or `OnChange` flags.

The important point to remember is that if an agreement is consumer initiated, then you should modify the subentry held on the consumer DSA, and if it is supplier initiated, you should modify the subentry held on the supplier DSA. If the agreement has the `OnChange` flag, you should modify the subentry held by the supplier DSA. If you disregard this advice, some modifications may not have the required effect.

#### 8.10.1.4 Configuring the Replication Schedule

To configure a specific replication schedule, modify the `shadowingBeginTime` attribute and `shadowingEndTime` attributes.

The following example schedules replication for four specific times each day, and within one hour windows of those times.

```
dxim> set <shadowingAgreement name> attributes -
_dxim> shadowingBeginTime=("0 010000", "0 070000", "0 130000", "0 190000"), -
_dxim> shadowingEndTime=("0 020000", "0 080000", "0 140000", "0 200000")
```

where the times are expressed in the format `d h:mm:ss`, such that "0 010000" is 1 a.m. Universal Time, "0 070000" is 7 a.m., "0 130000" is 1 p.m., and so on. Remember to specify universal times (GMT), not local times. (The `d` field in each value can be used to specify a day of the week. You could, therefore, configure a schedule with different times and frequencies for different days of the week.)

In this way, you can ensure that replication occurs when the network is least busy, and you can schedule different agreements to be processed at different times.

---

#### Note

You must make these schedule modifications to the shadowing agreement subentry held by the DSA that initiates replication. If you modify the agreement subentry of the DSA that is not the initiator of replication, then the modification does not have the required effect. Section 8.10.1.3 explains how to identify which DSA is the initiator of a given agreement.

---

Note also that schedules are ignored if `OnChange` replication is in force. See Section 8.10.1.6 for details of how to implement `OnChange` replication.

## Configuring DSAs

### 8.10 Implementing Replication

#### 8.10.1.5 Forcing Replication to Happen Immediately

In certain situations, you might want to force an immediate replication attempt as an exception to the normal schedule.

The usual way to do this is to use the NCL UPDATE DSA command. However, that method forces a total update, which is not very efficient. If you want to force an immediate incremental update, you can set the `shadowingNextUpdate` attribute to the any time in the past. You must modify the attribute in the agreement held by the DSA that initiates replication. For example, if today is July 6th 1995, you can cause replication to happen immediately using the following command:

```
dxim> set <shadowingAgreement name> -  
_dxim> attribute shadowingNextUpdate=19950705000000Z
```

This time represents the beginning of July 5th, which causes an immediate, replication attempt. Once this attempt is complete, the configured schedule is resumed.

Section 8.10.1.3 explains how to identify the initiator of replication for a given agreement. If you modify the `shadowingNextUpdate` attribute of the DSA that is not the initiator of replication, then the modification has no effect.

#### 8.10.1.6 Configuring Replication to Occur Only When Information Changes

An alternative to scheduled replication is OnChange replication. OnChange replication causes the supplier DSA to initiate replication whenever a change occurs in the relevant naming context. If no change occurs, the two DSAs do not communicate at all. If you use scheduled replication, the two DSAs communicate according to the schedule even when there are no changes to replicate.

To configure OnChange replication, use the following command to change the agreement held by the supplier DSA:

```
dxim> set <shadowingAgreement name> attributes -  
_dxim> shadowingFlags=UseDOP+IsSupplier+Onchange+OtherTimes
```

Note that it is important that you apply this combination of shadowing flags to the subentry held by the supplier, because it includes the `IsSupplier` flag. That flag must never be specified in the consumer DSA's agreement.

Note that when OnChange replication is in use, the attributes that configure the shadowing schedule are ignored, so there is no reason to modify them.

#### 8.10.1.7 Configuring Replication Back to the Default Behaviour

If you change a shadowing agreement to OnChange, but then decide that this style of replication is unsuitable for that agreement, you can configure the style of replication back to the default behaviour.

The default behaviour is defined by the following value for the `shadowingFlags` attribute in the agreement held by the consumer DSA:

```
shadowingFlags=UseDOP+ConsumerInitiated+OtherTimes
```

To return to this setting, identify the relevant shadowing agreement subentry, and use DXIM to modify it as shown in the following example:

```
dxim> set <shadowingAgreement name> attributes -  
_dxim> shadowingFlags=UseDOP+ConsumerInitiated+OtherTimes
```

This combination of flags means that replication is scheduled, and initiated by the consumer DSA. If the schedule interval has been customized, you might also want to reconfigure a 12 hour schedule using the attributes described in Section 8.10.1.4.

Another way to reinstate a default agreement is to use NCL to remove the details of the consumer DSA from the relevant Consumer Access Point held by the supplier DSA, and then add it back again after a few minutes. This causes the agreement to be terminated, and then recreated. The newly created agreement will be a default agreement. However, this method is inefficient because it causes the consumer DSA to delete its copy of the replicated naming context, and requires a complete new copy to be supplied when the agreement is recreated. This method is suitable if you decide that replication needs to be completely restarted for some reason.

### 8.10.2 Terminating Replication Agreements

If you decide that a consumer DSA no longer requires a given shadow naming context, you can simply remove the details of that DSA from the Consumer Access Point attribute of the Naming Context on the supplier DSA. For example:

```
NCL> REMOVE DSA NAMING CONTEXT "/C=US/O=Abacus" -  
_NCL> CONSUMER ACCESS POINT -  
_NCL> {[AE TITLE = "/C=US/O=Abacus/CN=DSA5", -  
_NCL> PRES ADDR ' "DSA"/"DSA"/"DSA"/NS+49aa001992aa3000000,CLNS' ]}
```

In this case, the DSA (the supplier) informs CN=DSA5 that it must delete the shadow naming context, and it supplies no further updates for that naming context to CN=DSA5. It may continue to supply updates for other naming contexts that it supplies to CN=DSA5.

---

#### Note

---

Do not attempt to terminate replication by deleting the relevant shadowing agreement subentry. As part of the automated management of replication, these subentries may be recreated if deleted, such that replication continues. The supported way to terminate replication is to amend the Consumer Access Point attribute as described above.

---

## 8.11 Disabling DSAs

The DISABLE DSA directive puts a DSA into state DISABLING, in which state it closes down its activities. When all activities have been terminated, the DSA goes into state OFF. For example:

```
NCL> DISABLE DSA
```

Disabling a DSA prevents it from receiving connections from directory applications and DSAs. This means that this DSA will not respond to user requests for information, and that it will not respond to other DSAs' attempts to replicate information or modify shadowing agreements.

In state OFF, you can use NCL commands to manage attributes of the DSA. You cannot use the UPDATE DSA directive when the DSA is in state OFF.

## Configuring DSAs

### 8.12 Deleting DSAs

## 8.12 Deleting DSAs

The DELETE DSA directive removes a DSA from a system. For example:

```
NCL> DELETE DSA
```

A deleted DSA is no longer configurable, and is not available to respond to connections from directory applications or other DSAs.

The time taken for the DELETE DSA directive to complete depends on the amount of directory information held by the DSA.

Tru64  
UNIX

This version of the DSA uses memory image files rather than the snapshot files of previous versions. Memory image files provide superior startup and shutdown times, especially for very large databases. They are stored in /var/dxd.

Snapshot files are only supported for a small number of reasons:

- So that you can upgrade from a previous version.
- So that you can load a new schema file (see Chapter 6).
- So that you can defragment the database (see Section 8.14).
- So that you can upgrade to a future version of the Enterprise Directory.

Different versions of the DSA may use different memory structures. A memory image file cannot, therefore, be supported through an upgrade. You need to make the DSA create a snapshot file shortly before an upgrade. The deinstallation procedure reminds you of this requirement if it finds no valid snapshot of the database.

For those few occasions when you need to use snapshot files, the CREATE DSA and DELETE DSA directives support a new command option:

```
NCL> CREATE DSA FROM SNAPSHOT  
NCL> DELETE DSA TO SNAPSHOT
```

If a given task requires you to create a snapshot file, the documentation makes this clear, and reminds you of the command option required.

◆

## 8.13 Starting the DSA as Part of OpenVMS System Startup

The installation card for OpenVMS systems explains that you can edit the system startup file to include the command that runs the Enterprise Directory startup file, SYSSSTARTUP:DXD\$COMMON\_STARTUP.COM.

This file runs an NCL script file for starting the DSA. By default, the commands in that NCL script file are commented out. This means that the DSA is not created or enabled. This is because a DSA cannot be enabled until it has been configured, so the NCL commands would cause errors during every system startup.



## 8.13 Starting the DSA as Part of OpenVMS System Startup

After configuring a DSA, edit the DSA startup script `SYS$STARTUP:DXD$DSA_STARTUP.NCL` to remove the comment characters. Next time the system reboots, the DSA will start up automatically.

On clusters the file is installed in the system specific startup directory, and must be edited there.

## 8.14 Defragmenting the Memory Image File (Tru64 UNIX)

The DSA on Tru64 UNIX systems uses memory image files instead of the snapshot files of previous versions. Memory image files provide superior startup and shutdown times, especially for very large databases.

The memory image file can become fragmented over time, for example, if you delete many entries, or stop the DSA from consuming a naming context.

You can compare the value of the DIT Memory Occupancy attribute of the DSA entity with the size of the DSA memory image files. Use the NCL `SHOW DSA DIT MEMORY OCCUPANCY` command to display the attribute. The memory image file should always be larger than the DIT Memory Occupancy attribute indicates, but if it is more than about 10 megabytes larger, you should consider defragmenting the database.

Use the following procedure to defragment the database.

1. Disable and delete the DSA using the following NCL commands:

```
ncl> DISABLE DSA
ncl> DELETE DSA TO SNAPSHOT
```

The deletion takes longer than usual because the DSA is forced to write a snapshot file, as in previous versions.

2. Use the following NCL commands to recreate and enable the DSA:

```
ncl> CREATE DSA FROM SNAPSHOT
ncl> ENABLE DSA
```

The creation takes longer than usual. When the creation is complete, the DSA has created a new, unfragmented memory image file.

## Configuring DSAs

### 8.14 Defragmenting the Memory Image File (Tru64 UNIX)

When the DSA has been recreated and enabled successfully, as shown in step 2, you can delete the snapshot file from the DSA system, as follows:

```
# rm /var/dxd/DSA-information-tree.snapshot*
```

The DSA does not need this file any longer, so you can save disk space by deleting it. Do not delete any of the other database files.

---

## Configuring and Running Directory Applications

This chapter documents the following:

- The DUA defaults file that is used by DXIM and the MAILbus 400 MTA
- The DXIM initialization file
- The Lookup Client defaults file that is used by the Compaq X.500 Lookup Client
- How to run DXIM and the Lookup Client

The DUA defaults file and the Lookup Client defaults file are both created by configuration utilities. In both cases, the configuration utilities create a defaults file that applies to all system users. However, individual users can have a customized copy of the defaults file in their local area if they want a different set of defaults.

---

### Note

---

In the case of DXIM, you can also configure some aspects of the user interface by editing the schema file DUA.SC (see Chapter 6). For example, you can configure user-friendly names for attributes.

---

## Configuring and Running Directory Applications

### 9.1 Using the DUA Configuration Utility

#### 9.1 Using the DUA Configuration Utility

The DUA configuration utility communicates with a DSA to find out its presentation address and AE title.

You need to run the utility on every system that runs DXIM, or the MAILbus 400 MTA. The DSA to which you want these applications to connect must be configured before you run the DUA configuration utility (see Section 5.2.3). The DSA may be on the same system as the applications, or remote.

The configuration utility contacts the relevant DSA to determine what values to use as DUA defaults. The DSA must be in state ON when you use the DUA configuration utility.

The configuration utility writes a DUA defaults file that includes the presentation address and AE title of a DSA on a specified node.

Tru64  
UNIX

You need superuser privileges to run the configuration utility. To run the utility, type:

```
# /var/dxd/scripts/dua_configure
```

◆

OpenVMS

You need SYSPRV and OPER privileges to run the configuration utility. To run the utility, type:

```
$ @SYS$STARTUP:DXD$DUA_CONFIGURE
```

◆

If your privileges are insufficient, the utility displays an error message and exits. Otherwise, the utility checks for the presence of both DECnet-Plus and RFC1006 on your system. Note that if both DECnet-Plus and RFC1006 are available, then the utility uses DECnet-Plus to connect to the DSA.

The utility then displays:

Enter the name of the node on which the DSA is located:

If the utility detects that there is a DSA installed on the local system, the local node name is offered as a default.

Specify the name of the DSA system and press RETURN. Note that there is no requirement for applications to use a local DSA, although that is more efficient. The option to use a remote DSA means that you can have applications on a system without a DSA.

When you specify a node name, the utility connects to the DSA on the specified system to find out what its presentation address and AE title are.

If DECnet-Plus is not present on your system, then the utility connects to the DSA using RFC1006. When using RFC1006 to connect to the DSA, the utility requests identifiers for the Upper Layer Selectors of the DSA's presentation address:

```
Please enter the Upper Layer Selectors ["DSA"/"DSA"/"DSA"]
```

## Configuring and Running Directory Applications

### 9.1 Using the DUA Configuration Utility

Note that the Upper Layer Selectors [ "DSA"/"DSA"/"DSA" ] are offered as a default. If you already know that these selectors are not used by the DSA, specify the correct selectors and press RETURN. If you do not know what selectors the DSA uses, press RETURN. It is most likely that the DSA uses the selectors shown by default.

Tru64  
UNIX

Having contacted the specified DSA, the utility writes the required information to `/etc/dua.defaults`, displays a success message, and exits. Any previous version of the defaults file is renamed to `/etc/dua.defaults.savn`, where *n* is an integer. No details from the existing version are included in the new version.

◆

OpenVMS

Having contacted the specified DSA, the utility writes the information to `DXD$DIRECTORY:DXD$DUA_DEFAULTS.DAT`, displays a success message, and exits. If a file of that name already exists, a new version is created. No details from the existing version are included in the new version.

◆

If the utility fails to contact the DSA on the specified node, or fails to obtain the presentation address and AE title information, it displays an error message, and asks whether you want to try a different DSA node. If you type **yes**, the utility asks you to specify the name of another node, and repeats the attempt to obtain defaults information and write a defaults file.

Having successfully used the utility to create a defaults file, you can invoke DXIM. DXIM automatically binds to the DSA whose details were written into the defaults file. This confirms that the defaults details are satisfactory.

Refer to Section 9.2 for further details about the defaults file, and to Section 9.3 for details of how an individual user can create and manage a defaults file for their own use of DXIM.

## 9.2 System-wide DUA Defaults

The configuration details that apply to a whole system are stored in the following files:

Tru64  
UNIX

`/etc/dua.defaults`

◆

OpenVMS

`DXD$DIRECTORY:DXD$DUA_DEFAULTS.DAT`

◆

The file created by the configuration utility contains a number of defaults in addition to the presentation address and AE title. The following is a typical defaults file created by the utility:

## Configuring and Running Directory Applications

### 9.2 System-wide DUA Defaults

```
DUA.KnownDSAs.paddr = "DSA"/"DSA"/"DSA"/NS+490020001122ABA0012,CLNS
DUA.KnownDSAs.ae_title = /C=US/O=Abacus/CN=DSA1

#DUA.PreferChaining = true
#DUA.ChainingProhibited = false
#DUA.LocalScope = false
#DUA.DontUseCopy = false
#DUA.DontDereferenceAliases = false
#DUA.ScopeOfReferral = DMD
#DUA.TimeLimit = 60
#DUA.SizeLimit = 30
#DUA.Priority = Medium
#DUA.DomainRoot = /
#DUA.InitialEntry = /
```

The # character at the beginning of most lines is a comment character. DXIM ignores lines that begin with a # character. By default, only the presentation address and AE title defaults are active. To use a particular default, specify the required value and remove the comment character from the line.

In addition to the list of defaults shown above, there are two defaults that you can add to the defaults file manually. These are:

```
DUA.AttributeSizeLimit = integer
DUA.CopyShallDO = True|False
```

Note that if you specify a given default more than once, only the first instance is ever used. If the first instance of a default is invalid, DXIM does not attempt to use a subsequent definition. There is no advantage in specifying more than one known DSA presentation address, for example.

Each default must be specified on a separate line, and must not wrap onto a second line.

The defaults that specify `true` or `false` are booleans, and you can change them from one value to the other. No other value is allowed for these defaults.

The `DUA.ScopeOfReferral` default specifies a restriction on any referrals returned by a DSA. The permitted values of this control are:

- `DMD` (meaning directory management domain)
- `country`
- `world`

The `DUA.ScopeOfReferral` default means that when your DSA cannot satisfy a request, it can instead return a referral to the application, suggesting further DSAs to contact, but only suggesting DSAs within the specified scope.

---

#### Note

---

Compaq's DSAs do not support this control, and do not provide a way to define the scopes. However, other vendor's DSAs might enable you to define scopes, in which case this control might become relevant.

---

The `DUA.TimeLimit` default specifies the number of seconds permitted for each user request to be answered. The value must be an integer no higher than 65535. The value 0 means that there is no time limit. By default, Compaq's DSA imposes no time limit.

## Configuring and Running Directory Applications

### 9.2 System-wide DUA Defaults

The `DUA.SizeLimit` default specifies the number of entries that can be returned for a single user request. The value must be an integer no higher than 65535. A value of 0 means that there is no limit on the number of entries that can be returned for a single request. By default, Compaq's DSA imposes no size limit.

---

#### Note

---

This control applies to the number of entries returned from a given Compaq DSA, rather than to all DSAs. For example, a value of 10 means that each DSA that handles the request can return up to 10 entries. If five DSAs help satisfy a request, a total of 50 entries might be returned.

---

The `DUA.Priority` default specifies a default priority for all user requests. The permitted values are:

- Low
- Medium
- High

---

#### Note

---

Compaq's DSAs do not prioritize user requests. Other vendors' DSAs might, in which case this control might become relevant.

---

The `DUA.DomainRoot` default specifies a default prefix for all user commands that include incomplete distinguished names.

Use this control to specify the name of the entry at the top of your organization's DIT, or of some entry within your organization's DIT. The Abacus organization, for example, would edit this control to specify `/C=US/O=Abacus`. You can specify any valid directory name as the domain root.

---

#### Note

---

If you specify the `/` character, make sure that there are no spaces after the `/` character.

If you specify a distinguished name that contains space characters, quote the particular value(s) that contain the spaces, rather than quoting the entire name. For example: `/C=US/O="ACME Co"` rather than `"/C=US/O=ACME Co"`.

---

This default enables a DXIM user to omit those terms from any distinguished name. For example, if the domain root is `/C=US/O=Abacus`, a DXIM user could use the following SHOW command:

```
dxim> show ou=sales/cn="Bryan Lea"
```

DXIM displays the entry `/C=US/O=Abacus/ou=sales/cn="Bryan Lea"`

The prefixing option also applies to distinguished names specified in attribute values. For example, you could specify an `aliasedObjectName` attribute as follows:

```
aliasedObjectName="ou=sales/cn=Bryan Lea"
```

## Configuring and Running Directory Applications

### 9.2 System-wide DUA Defaults

The `DUA.InitialEntry` default specifies the name of a directory entry that is to be the default browse and search base for DXIM. By default, all commands apply to the initial entry, unless the user specifies otherwise.

As with `DUA.DomainRoot`, specify the name of the entry at the top of your organization's DIT, or of an entry within your organization's DIT.

---

#### Note

---

If you specify the `/` character, make sure that there are no spaces after the `/` character.

If you specify a distinguished name that contains space characters, quote the particular value(s) that contain the spaces, rather than quoting the entire name. For example: `/C=US/O="ACME Co"` rather than `"/C=US/O=ACME Co"`.

---

If you do not specify a value for this default, DXIM uses `DUA.DomainRoot` as the initial entry. If neither default is specified, DXIM defaults to `/`, which might prove expensive, and might prevent the use of the DXIM Browse window.

The value of `DUA.InitialEntry` also provides a second prefixing option. For example, if the initial entry is `/C=US/O=Abacus`, a DXIM user could use the following command:

```
dxim> show ./ou=sales/cn="Bryan Lea"
```

DXIM displays the entry `/C=US/O=Abacus/ou=sales/cn="Bryan Lea"`. The period character before the leading `/` is converted into the value of initial entry. This prefixing option cannot be used within attribute values, unlike the domain root.

The `DUA.DomainRoot` and `DUA.InitialEntry` controls are the ones that are most likely to need changing before you allow DXIM to be used by your user community.

The `DUA.AttributeSizeLimit` control enables you to specify a limit on the size of attribute values that you want returned in a request. This is useful if the DSA stores very large attributes. For example, the DSA supports the `jpegPhoto` attribute which can store images. If your directory application does not support the display of images, then you can set this control to ensure that images, which tend to be very large, are not returned. Specify the number of bytes that is to be the attribute size limit. The DXIM command line interface supports a `maximum attribute size` control that enables you to specify a limit interactively, to override the default. If you do not use this control, the DSA does not limit the size of attribute values it returns.

The `DUA.CopyShallDo` control enables you to indicate whether you want information from partial copies of entries. Compaq DSAs do not support partial copies of entries, so this control is only useful if you have another vendor's DSA. Specify a default of `TRUE` or `FALSE`. If you do not use this control, the default setting is `FALSE`. The DXIM command line interface supports a `partial information` control that enables you to specify that partial information is acceptable interactively to override the default.



## 9.3 DUA Defaults for Specific Users

By default, all users are affected by the system-wide defaults file. Individual directory users might want to have their own definitions of some of the DUA defaults.

To provide an individual directory user with their own defaults for use of the directory, create a file in the user's home or default directory, with the following name:

Tru64 UNIX	<code>\$HOME/dua.defaults</code> ◆
OpenVMS	<code>SYS\$LOGIN:DXD\$DUA_DEFAULTS.DAT</code> ◆

Edit the file to specify one or more of the following defaults:

```
DUA.DomainRoot
DUA.InitialEntry
DUA.Requestor
DUA.KnownDSAs.paddr
```

Note that none of the other defaults listed in Section 9.2 are used in the user defaults file. If you specify them, they are ignored. The four defaults listed above, if present, override the values in the system defaults file. For example, the value of `DUA.DomainRoot` in a user defaults file overrides the value in the system defaults file.

See Section 9.2 describes the `DUA.DomainRoot` and `DUA.InitialEntry` defaults.

The `DUA.Requestor` default specifies the distinguished name by which the user wants to be identified to the DSA. When the user invokes `DXIM`, the value of `DUA.Requestor` is passed to the Enterprise Directory.

---

### Note

---

If you specify a distinguished name that contains space characters, quote the particular value(s) that contain the spaces, rather than quoting the entire name. For example: `/C=US/O="ACME Co"` rather than `"/C=US/O=ACME Co"`.

---

Note that although the user's name is passed to the DSA, their password is not. If the user is using the `DXIM` windows interface, they can use the Authenticate window. The Name field of that window is filled in automatically, so that the user only has to supply a password to achieve simple authentication. If the user is using the `DXIM` command line interface, they need to use the `BIND` command with the Password argument.

If there is no default requestor name in user defaults, then the Enterprise Directory treats the user as an unauthenticated, unnamed user. The user can still use the Authenticate window, or the `DXIM BIND` command to specify their name and password.

Note that the `DUA.Requestor` default is not specified in the system defaults file. `DXIM` only uses `DUA.Requestor` defaults specified in user defaults files.

## Configuring and Running Directory Applications

### 9.3 DUA Defaults for Specific Users

The `DUA.KnownDSAs.paddr` default specifies the presentation address of a DSA. For example:

```
DUA.KnownDSAs.paddr = "DSA"/"DSA"/"DSA"/NS+490020001122ABA0012,CLNS
```

This is the presentation address of the DSA to which the DXIM windows interface binds on invocation for this user. It is also the default presentation address for the DXIM command line interface, so that when the user uses the `BIND` command, they do not need to type a presentation address. If there is no presentation address specified in user defaults, the default specified in the system defaults file is used.

### 9.4 Configuring DXIM to Use Another Vendor's DSA

If you want to configure the DXIM utility to use another vendor's DSA, you might need to do this manually. If the other vendor's DSA supports RFC1006 connections, and the DSA is running, then the configuration procedure might succeed.

However, if the configuration procedure fails, you need to find out the presentation address of the DSA, and edit the `DUA.KnownDSAs.paddr` parameter in the defaults file manually.

### 9.5 DXIM Command Line Initialization Files

When you use the DXIM command line interface, you can use an initialization file in addition to the two defaults files. The initialization file is executed after DXIM has read the defaults files, and will override defaults specified in those files if appropriate. The initialization file must be created in your home or default directory.

The initialization file contains DXIM commands that are executed when you invoke the command line interface. For example, you could create an initialization file that contains a `DXIM SET DEFAULT NO CHAINING` command.

The initialization file has the following name:

Tru64 UNIX	<code>\$HOME/.dximrc</code> ◆
OpenVMS	<code>SYS\$LOGIN:DXD\$DXIM.INI</code> ◆

The initialization file can contain any DXIM commands. For example:

```
bind to address "DSA"/"DSA"/"DSA"/NS+490020001122000033,CLNS
set current /c=us/o=abacus/ou=sales
```

The example file uses a `bind` command to establish a binding to a particular DSA. It then defines a current entry, which overrides the value of `DUA.InitialEntry`. Refer to the DXIM online help for full details of these and other DXIM commands.

## 9.6 Running DXIM

To run DXIM using the Motif windows interface, type one of the following:

```
Tru64
UNIX  $ dxim
      ◆
```

```
OpenVMS $ DXIM
        $ DXIM /INTERFACE=DECWINDOWS
      ◆
```

To run DXIM using the command line interface, type one of the following:

```
Tru64
UNIX  $ dxim -c
      ◆
```

```
OpenVMS $ DXIM /INTERFACE=CHARACTER_CELL
      ◆
```

Note that /INTERFACE=DECWINDOWS is the default for OpenVMS systems.

You can also use DXIM from the shell or system prompt. For example, you can type:

```
Tru64
UNIX  $ dxim show /countryname=US all attributes
      ◆
```

```
OpenVMS $ DXIM SHOW /COUNTRYNAME=US ALL ATTRIBUTES
      ◆
```

The presence of a DXIM command line means that it is not necessary to specify `-c` or `/INTERFACE=CHARACTER_CELL`.

## 9.7 Using the Lookup Client Configuration Utility

If you install the Compaq X.500 Lookup Client, then you need to run a configuration utility before you can use it.

Run the Lookup Client configuration utility, as follows:

```
Tru64
UNIX  # /usr/sbin/dxdlu_configure
      ◆
```

```
OpenVMS $ @SYS$STARTUP:DXD$LUC_CONFIGURE.COM
      ◆
```

Specify the name of the system that runs the DSA with a non-zero LDAP port.

The utility then prompts for a search base. Specify the name of an entry within your organization's DIT. For example, you could specify the name of the highest entry in your organization's DIT. Note that the Lookup Client uses a different convention for naming directory entries, such that an entry called /C=US/O=Abacus must be expressed as follows:

## Configuring and Running Directory Applications

### 9.7 Using the Lookup Client Configuration Utility

O=Abacus, C=US

The utility asks whether you want to specify another search base. Multiple search bases are supported by the Lookup Client windows interface. The search bases are offered as a menu enabling users to select a particular search base. The first search base you specify is the default search base, and is the only search base available to users of the Lookup Client command line interface.

Every time you specify a search base, the utility asks whether you want to specify another. When you have specified all of the search bases you require, type n, and the utility will exit.

The utility writes a defaults file called:

Tru64 UNIX	# /etc/dxdlu.defaults ◆
OpenVMS	\$ @SYS\$SYSTEM:DXDLU.DEFAULTS ◆

The defaults file is self documenting. The file defines what attributes the Lookup Client can display and manage, which attributes are searchable, how the Lookup Client handles search strings, what object class is searched for, what service controls to apply, and what fonts to use. For details of all of the defaults, refer to the defaults file. You can customize the file as described in the comments.

The defaults file applies to all users of the Lookup Client on the system, although individual users can make a copy of the file in their local area if they want a different set of defaults. When you invoke the Lookup Client, it checks for a defaults file in the areas defined by the \$HOME environment variable, or SYS\$LOGIN.

## 9.8 Running the Lookup Client

You can run the Lookup Client graphical interface as follows:

```
Tru64
UNIX # dxdlu
◆
```

```
OpenVMS $ RUN SYS$SYSTEM:DXD$LOOKUP_MOTIF.EXE
◆
```

You can run the command line interface as follows:

```
Tru64
UNIX # dxdlu -c
◆
```

```
OpenVMS $ RUN SYS$SYSTEM:DXD$LOOKUP_CLI.EXE
```

On OpenVMS systems, you can define foreign commands for running the utility, for example:

```
$ DXDLU ::= RUN SYS$SYSTEM:DXD$LOOKUP_MOTIF.EXE
$ DXDLUCLI ::= RUN SYS$SYSTEM:DXD$LOOKUP_CLI.EXE
◆
```

The online help for the utilities explains how to use them.



---

## Creating Directory Entries

This chapter describes how to create entries in the directory (or how to *populate* the directory).

Section 10.1 explains how to populate the directory using DXIM script files. Using DXIM script files to populate the directory is most useful when you are creating a DIT for the first time.

Section 10.2 explains how to create entries interactively, using the DXIM command line interface. Creating entries interactively is most useful when you want to add a small number of entries after the directory has been populated.

You can also create entries interactively using the DXIM windows interface. For details of how to do this, see Section 10.2 or refer to the DXIM windows utility online help.

Section 10.3 explains the DXIM facilities for managing multiple entries and reading and writing entry information to and from files. These facilities are useful if, for example, you want to make the same modification to a large number of entries, you want to delete a large number of entries, or you want to create entries based on information held in a text file.

Remember that you need to create entries to represent your Compaq DSAs (see Section 4.5). You can create your DSA entries along with all other entries, or create them as a separate task. However, you should certainly create them before allowing end users to access the directory, because they support Enterprise Directory security.

In all cases, before you start creating entries in the directory, it is important to understand the following points:

- You cannot create entries unless you have configured the DSAs that are to hold them (see Chapter 8).
- Compaq suggests that when you initially populate the directory, you should do it one naming context at a time, using script files which you keep.

The most efficient way to populate the directory is to bind to the master DSA for a given naming context and use a script file to create all of the entries for that naming context, and then unbind.

Repeat this process for each master DSA until all naming contexts are populated. The script should succeed even if you bind to some other DSA, but you will be keeping two or more DSAs busy, rather than just the master DSA.

- If you are *absolutely sure* that a script file creates entries that conform to the schema, then you can configure the DSA not to do schema checking. Commands are executed faster if no schema checks are required, but at the risk of creating invalid entries. Refer to the NCL Directory module help for details of the DSA Schema Check On Modify attribute. You should only disable schema checks for as long as it takes to run the script file.

## Creating Directory Entries

- Use the DSA Volatile Modifications characteristic attribute to specify that the DSA need not log the modifications immediately (see Section 8.3.3).
- Within a naming context, you cannot create an entry until after you create its superior entry.

For example, you would create the entry called `/ou=Sales` before creating the entry `/ou=Sales/cn="Jon Long"`.

- It does not matter what order you populate the naming contexts in.
- If access controls have already been implemented for the DSA that is to hold the entries you create, then you might need to authenticate.

If you are using the command line interface, use the `DXIM BIND` command with the `NAME` and `PASSWORD` arguments before creating the entries.

If you are using the windows interface, pull down the Directory menu and select the Authenticate option. Specify your distinguished name and your password, and click on OK.

### 10.1 Using a Script File to Populate a Naming Context

This section explains how to use a DXIM script file to populate a naming context. You do not have to populate the directory one naming context at a time, but it is a logical and efficient method. If you use script files, it may be useful to keep them for reference purposes.

1. Check that the master DSA for the naming context is configured correctly.
  - The master DSA requires a Naming Context entity. The name of the Naming Context entity must be the same as the distinguished name of the first entry that you create within that naming context.

Use the `NCL SHOW` command to verify the existence of the Naming Context entity, as follows:

```
NCL> SHOW DSA NAMING CONTEXT <name> ALL ATTRIBUTES
```

where `<name>` is the name of the naming context and also the distinguished name of the first entry that you will create in that naming context.

- Also, if the naming context you intend to populate is to be superior to any other naming context, then you are advised to make sure that Subordinate Reference entities have been created for each subordinate naming context. This ensures that you cannot accidentally create entries on one DSA that should be created on another.

Use the `NCL SHOW` command to verify the existence of each Subordinate Reference entity, as follows:

```
NCL> SHOW DSA SUBORDINATE REFERENCE <name>
```

where `<name>` is the name of a Subordinate Reference entity, and is also the name of the naming context to which the Subordinate Reference entity refers.

2. Create a DXIM script file containing a `DXIM BIND` command and a series of `CREATE` commands:
  - The `BIND` command specifies the presentation address of the master DSA for the naming context you are going to populate. If access controls are



## Creating Directory Entries

### 10.1 Using a Script File to Populate a Naming Context

implemented, you can specify your distinguished name and password in the BIND command.

Binding to the master DSA for the naming context ensures optimal performance.

- Each CREATE command creates one directory entry.

The first command creates the entry that has the same name as the Naming Context entity.

With the exception of that first command, each CREATE command creates an entry as a subordinate of another entry. You cannot create an entry unless its parent exists, unless, as in the case of the first command, the entry is also the root of a naming context.

- Each CREATE command specifies the class of the entry being created, and includes a list of the entry's attributes and values.
- Make sure that each CREATE command specifies all of the mandatory attributes for each entry. Also, make sure that each entry is created with the planned name, using the appropriate attributes for naming.
- Make sure that you do not attempt to create any entries that do not belong in the particular naming context you are populating. For example, do not create entries that belong in subordinate naming contexts. Such commands might succeed, depending on how completely you have configured your DSAs, but even if they do succeed, this is not an efficient way to populate the DIT.

The following is an extract of a DXIM script file for a typical naming context:

```
! bind to the DSA on node WANGLE
bind to address "DSA"/"DSA"/"DSA"/NS+4900100363AB72002020,CLNS
!
! create the first entry in the naming context.
!
create /c=US/o=abacus/ou=sales attributes -
  objectClass=organizationalUnit, -
  description="Sales and Marketing Group"
!
!
! use the set current command to save some typing on further
! creates, by specifying Sales to be the current entry
!
set current /c=us/o=abacus/ou=sales
!
! populate the sales group with employees.
!
create ./cn="Janet Gold" attributes -
  objectClass=(person,organizationalPerson), -
  surname=Gold, telephoneNumber=899090, description="Salesperson", -
  title="Principal Sales Coordinator", faxno=899000, -
  commonName=("Jan Gold","Janet Gould")
!
create ./cn="Bill Marx" attributes -
  objectClass=(person,organizationalPerson), surname=Marx, -
  commonName=("William Marx","Will Marx","William Marks"), -
  telephoneNumber=898988
!
! create the Drugs organizational unit underneath Sales
!
create ./ou=drugs attributes objectClass=organizationalUnit
```

## Creating Directory Entries

### 10.1 Using a Script File to Populate a Naming Context

```
!  
! use the set current command to save some typing.  
!  
set current /c=us/o=abacus/ou=sales/ou=drugs  
!  
! populate the Drugs group with employees  
!  
create ./cn="Justin Wells" attributes -  
  objectClass=(person,organizationalPerson), -  
  surname=Wells, telephoneNumber=894545, -  
  description="Senior Pharmacologist"  
.  
.  
.
```

3. Invoke DXIM in such a way that output is directed to a file, and use the DXIM do command to execute the DXIM script file. For example:

Tru64 UNIX	\$ /usr/bin/dxim -c 'do script.file' >& output.lis
	◆
OpenVMS	\$ DEFINE /USER SYS\$OUTPUT output.lis \$ DXIM /INTERFACE=CHARACTER_CELL DO SCRIPT.FILE
	◆

If the script file fails to create an entry, then it will also fail to create any subordinates of that entry.

4. Refer to the output file to see whether there were any errors.  
If any part of the naming context was not populated, amend the script file. Discard or comment out any commands that succeeded the first time, and amend the command(s) that failed as necessary. Run the script file again, and repeat the process until the naming context is fully populated.

### 10.2 Creating Entries Interactively

This section explains how to create entries interactively using the DXIM management utility. Interactive entry creation is most suitable if you have a small number of entries to create.

When you create an entry interactively, it is less important that you bind directly to the master DSA for that entry. A small number of modifications can be passed to the relevant master DSA without inconveniencing the DSA to which you are bound.

If you have configured your DSAs correctly (see Chapter 8) then whichever DSA you bind to will pass the request to the master DSA automatically. If this fails, then you need to find out which DSA has inaccurate or insufficient configuration, and correct it. It is important that your DSAs are configured correctly because an important part of the service they provide is the ability to pass requests to the correct DSA automatically.

Invoke DXIM using the DXIM shell or DCL command (see Section 9.6). DXIM displays the `dxim>` prompt. If DXIM does not bind automatically using defaults information (see Chapter 9), use the DXIM bind command, for example:

```
dxim> bind to address <presentation_address>
```

where `<presentation_address>` is the network presentation address of a DSA.

## Creating Directory Entries

### 10.2 Creating Entries Interactively

If access controls are implemented, then the bind command can include your distinguished name and password. For example:

```
dxim> bind to address <presentation_address> -  
_dxim> name /c=us/o=abacus/ou=sales/cn="Jon Hunter" password  
Password>
```

Having bound successfully, type a DXIM command to create an entry:

```
dxim> create entry <distinguished_name> attributes <attr>=<value> ...
```

If the command fails, DXIM displays an error message. Refer to the DXIM online help for full details of the command syntax and of DXIM error messages.

To create an entry using the DXIM windows interface, use the Browse window to find the parent of the entry that you want to create. If you cannot find the parent entry using the Browse window, then you cannot create the new entry. If the entry configured to be the Browse base is not yet created, you cannot create any entries using the windows interface. The windows interface only allows you to create a new entry if it can find the parent entry.

If access controls are implemented, pull down the Directory menu and select the Authenticate option. Specify your distinguished name and password, and click on OK.

Click on the parent of the entry you want to create, and select the Create option from the Edit menu. Select a class of entry from the Create submenu. DXIM displays a Create window for that class of entry. Add values to the various attributes. Remember to supply values for all mandatory attributes, and to specify naming attributes. When you have finished, click on the OK button. DXIM attempts to create the entry. If it fails, DXIM displays an error message explaining why. Amend the window to correct the errors, and click on OK again.

If you want to create several entries as subordinates of the same parent, all of the same class, and with several attribute values in common, you can click on the Apply button to create an entry. In this case, when DXIM creates the entry, it leaves the Create window on your screen. Amend the window to suit the second entry you want to create, and then click on Apply again. Remember to change the naming attributes, otherwise DXIM displays an error stating that the entry already exists. You can repeat this process for any number of new entries of the same class with the same parent entry.

### 10.3 Managing Multiple Entries

One of the features of a very large Enterprise Directory can be that entry administration becomes a very repetitive and time consuming activity. The DXIM command line interface provides facilities for managing multiple entries much more efficiently than the basic services allow.

Typical uses of these facilities are:

- Making the same modification to many entries at once
- Moving entire subtrees from one position in the DIT to another
- Renaming an entry that has other entries beneath it
- Creating entries based on information that DXIM reads from a file
- Writing entry information to a DXIM script file
- Writing entry information to a file whose format you define

## Creating Directory Entries

### 10.3 Managing Multiple Entries

The key to many of these activities is the ability to select multiple entries based on a search filter. Having made a selection, you can then apply a management command to the selection. For example:

```
dxim> select /C=US/O=Abacus where surname=Smith  
Number of entries selected is 14.
```

```
dxim> modify selected add value surname=Smyth
```

The first command selects a number of entries that match the specified search filter, and the second command applies a modification to all of those entries. This is clearly a lot easier than modifying each of the entries individually.

For full details of the activities listed above, see the online help for the DXIM command line interface.

## Using the Access Control Template File

This chapter describes how to use the access control template file to set up access controls for a naming context. See Chapter 7 for details of how to plan access controls for your DIT.

The access control template file is called:

Tru64 UNIX	<code>/var/dxd/scripts/dxd_aci_template.dxim</code>
---------------	-----------------------------------------------------

OpenVMS	<code>DXD\$DIRECTORY:DXD\$ACI_TEMPLATE.DXIM</code>
---------	----------------------------------------------------

The template file contains two incomplete DXIM commands. The first command creates an entry of the `accessControlSubentry` class. This entry will contain the access control information. This command only has any effect the first time you use the template file. The second command sets the value of the `prescriptiveACI` attribute of that entry. Every time you execute the template file, the command deletes and replaces any existing value of the `prescriptiveACI` attribute.

To use the template file, complete the following steps:

1. Edit the CREATE ENTRY command line to specify the distinguished name of the `accessControlSubentry`.

For example:

```
create entry -
  attribute objectclass=(accessControlSubentry, subentry)
```

becomes:

```
create entry /c=us/o=abacus/cn="access control" -
  attribute objectclass=(accessControlSubentry, subentry)
```

2. Edit the SET ENTRY command line to specify the distinguished name of the `accessControlSubentry` that is to hold the access control information. For example:

```
set entry -
```

becomes:

```
set entry /c=us/o=abacus/cn="access control" -
```

3. Edit the "Directory Managers" ACIitem to specify the name of at least one user who is to have full access to all directory information.

## Using the Access Control Template File

Specify the distinguished name of at least one user. Use the DXIM SHOW command to verify that the distinguished name exists. At least one of the names you specify must already exist when you execute the template file.

4. Use DXIM to make sure that the immediate superior entry of the `accessControlSubentry` already exists.

For example, the Abacus manager checks the existence of the organization entry, as follows:

```
dxim> show /c=us/o=abacus
```

5. Use DXIM to execute the template file, as follows:

```
Tru64  
UNIX  
dxim> do /var/dxd/scripts/dxd_aci_template  
◆
```

```
OpenVMS  
dxim> DO DXD$DIRECTORY:DXD$ACI_TEMPLATE.DXIM  
◆
```

Once you have completed these tasks, access control is implemented for the naming context that contains the `accessControlSubentry` entry. The controls may also be inherited by one or more subordinate naming contexts on the same DSA.

To ensure that all shadow copies of the naming context have the same access controls, update all shadow copies of the relevant naming context. See Section 8.10 for details of the UPDATE DSA command.

Keep the template file for future reference. If you ever need to change access controls, edit and execute the template file again (see Section 7.5.1 for notes on customizing the access control template file). The CREATE ENTRY command fails, but the SET ENTRY command replaces the existing value of the `prescriptiveACI` attribute. You can comment out or delete the CREATE ENTRY command if you prefer.

---

## Default Schema Definitions

OpenVMS Enterprise Directory for eBusiness provides a default schema which includes definitions agreed by the international standards organizations. The default schema also includes many definitions required by Compaq applications, including the DSA itself. Do not modify any of these definitions. If you modify these definitions you may have problems interworking with other Directory Services, or problems running Compaq's applications. You might even prevent Compaq's DSA from working properly. In particular, do not modify definitions in DEC.SC. Also, MTS.SC contains definitions required by the MAILbus 400 MTA product, and must not be edited.

You can, however, define extra definitions for your own use, or for use by specific applications. See Chapter 6 for details of customizing the schema.

This appendix describes the classes, attributes, attribute sets, and syntaxes of the default schema. Wherever possible you should use these definitions when planning entries, rather than specify new definitions of your own.

### A.1 Object Classes

The following sections give details of object classes defined in Compaq's default schema for use in a typical organization's directory information tree (DIT).

The default schema also includes many definitions for application use. Those definitions are not documented here. This section documents the definitions that you are most likely to want to use or refer to.

#### A.1.1 accessControlSubentry

This object class is used for entries that contain access control information. The DSA uses this information to determine what access is permitted to a given part of the directory information tree.

Note that commands that affect multiple entries, such as DXIM SHOW SUBORDINATES and SEARCH commands, do not normally display subentries. These commands provide a control that indicates whether subentries should be displayed. This prevents subentries from being seen by end users.

See Chapter 7 for details of how to plan your use of this class if you want to implement access controls.

##### **Mandatory Attributes**

objectClass  
commonName

## Default Schema Definitions

### A.1 Object Classes

#### Optional Attributes

prescriptiveACI

#### Naming Rules

You must use the `commonName` attribute for naming.

#### Structure Rules

The `accessControlSubentry` is a special case. It does not have a structure rule like other classes. You can only create an entry of this class beneath an entry that is at the top of a naming context. The information in the entry defines the access controls to be applied to all entries in that naming context, and to any subordinate naming contexts that do not have an `accessControlSubentry` of their own.

#### A.1.2 alias

This object class is used as the basis of schema definitions for specific alias classes. You cannot create entries of the alias class.

When you want to create an alias entry, use one of the subclasses of the `alias` class. For example, to create an alias for a device, use the `deviceAlias` class.

Each of the subclasses of `alias` permits the use of an appropriate naming attribute so that you can create aliases that have names similar to those of other classes.

#### Mandatory Attributes

`objectClass`  
`aliasedObjectName`

#### Optional Attributes

This object class has no optional attributes.

#### Naming Rules

You cannot create an entry of the `alias` class itself. Therefore, there are no naming rules for this object class. Each subclass of the `alias` class specifies a naming rule.

#### Structure Rules

You cannot create an entry of the `alias` class itself. Therefore, there are no structure rules for this object class. Each subclass of the `alias` class specifies a structure rule.

#### A.1.3 applicationEntity

`applicationEntity` entries represent software application entities.

An application entity is an entity within an OSI network that performs some task for an application process, for example, routing messages, locating and returning requested information. Such an application entity could be an X.400 Message Transfer Agent.

**See also** `applicationProcess`.



**Mandatory Attributes**

objectClass  
commonName  
presentationAddress

**Optional Attributes**

description  
organizationalUnitName  
organizationName  
localityName  
seeAlso  
supportedApplicationContext

**Naming Rules**

The `commonName` attribute must be used for naming.

**Structure Rules**

`applicationEntity` entries must have an immediately superior entry of the object class `applicationProcess`.

This is defined in the schema file DIT.SC as `applicationEntityStructureRule`.

An `applicationEntity` entry is not permitted immediately beneath the root of the directory information tree.

**A.1.4 applicationEntityAlias**

`applicationEntityAlias` entries represent aliases for software application entities.

**Mandatory Attributes**

objectClass  
commonName  
aliasedObjectName

**Optional Attributes**

There are no optional attributes for this class.

**Naming Rules**

The `commonName` attribute must be used for naming.

**Structure Rules**

A directory entry of the object class `applicationEntityAlias` must have an immediately superior entry of the following object class:  
`applicationProcess`

This is defined in the schema file DIT.SC as `applicationEntityAliasStructureRule`.

An `applicationEntityAlias` entry is not permitted immediately beneath the root of the directory information tree.

## Default Schema Definitions

### A.1 Object Classes

#### A.1.5 applicationProcess

`applicationProcess` entries represent software application processes.

An application process is an element within an open system that performs the information processing for a particular application, as defined in the ITU-T X.200 Series of Recommendations.

**See also** `applicationEntity`.

##### Mandatory Attributes

`objectClass`  
`commonName`

##### Optional Attributes

`description`  
`localityName`  
`organizationalUnitName`  
`seeAlso`

##### Naming Rules

The `commonName` attribute must be used for naming.

##### Structure Rules

A directory entry of the object class `applicationProcess` must have an immediately superior entry of one of the object classes:

`organization`  
`organizationalUnit`  
`locality`

This is defined in the schema file `DIT.SC` as `applicationProcessStructureRule`.

An `applicationProcess` entry is not permitted immediately beneath the root of the directory information tree.

#### A.1.6 applicationProcessAlias

`applicationProcessAlias` entries represent aliases for software application processes.

##### Mandatory Attributes

`objectClass`  
`commonName`  
`aliasedObjectName`

##### Optional Attributes

There are no optional attributes for this class.

##### Naming Rules

The `commonName` attribute must be used for naming.

### Structure Rules

A directory entry of the object class `applicationProcessAlias` must have an immediately superior entry of one of the object classes:

`organization`  
`organizationalUnit`  
`locality`

This is defined in the schema file `DIT.SC` as `applicationProcessAliasStructureRule`.

An `applicationProcessAlias` entry is not permitted immediately beneath the root of the directory information tree.

## A.1.7 country

This structural object class is used to define entries in the DIT that represent countries.

Note that you should only create an entry to represent a country if your organization is the Directory Administration Authority for that country. If you create a country entry without authority, you may have problems connecting to a global Enterprise Directory in the future. You should only represent objects that are part of your organization. See Chapter 4 for advice on what classes to use in your organization's DIT.

### Mandatory Attributes

`objectClass`  
`countryName`

### Optional Attributes

`description`  
`searchGuide`

### Naming Rules

Attribute `countryName` must be used for naming.

### Structure Rules

A `country` entry must be immediately beneath the logical root of the DIT, it cannot be subordinate to an entry of any other class.

This rule is defined in the schema file `DIT.SC`, and is called `countryStructureRule`.

## A.1.8 countryAlias

This alias object class is used to define alias entries that represent countries.

### Mandatory Attributes

`objectClass`  
`countryName`  
`aliasedObjectName`

### Optional Attributes

This class has no optional attributes.

### Naming Rules

Attribute `countryName` must be used for naming.

## Default Schema Definitions

### A.1 Object Classes

#### Structure Rules

A `countryAlias` entry must be immediately beneath the logical root of the DIT, it cannot be subordinate to an entry of any other class.

This rule is defined in the schema file `DIT.SC`, and is called `countryAliasStructureRule`.

#### A.1.9 decDSA

This object class is used to represent Compaq DSAs in the DIT. Entries of this class are required for security and optimal performance of a Enterprise Directory that uses Compaq DSAs. Chapter 4 explains how to plan `decDSA` entries.

This object class is a subclass of `dSA` and `applicationEntity`. When you create an entry of this class using the DXIM command line interface, you must specify the `objectClass` as follows:

```
... objectClass=(decDSA,dSA,applicationEntity)
```

**See also** `applicationEntity` and `dSA`.

#### Mandatory Attributes

```
objectClass  
commonName  
presentationAddress
```

#### Optional Attributes

```
trustedDSAName  
supportedApplicationContext  
protocolInformation  
userPassword  
description  
knowledgeInformation  
localityName  
organizationName  
organizationalUnitName  
seeAlso
```

#### Naming Rules

The `commonName` attribute must be used for naming.

#### Structure Rules

A directory entry of the object class `decDSA` must have an immediately superior entry of one of the following object classes:

```
country  
locality  
organization  
organizationalUnit
```

This is defined in the schema file `DIT.SC` as `decDSAStructureRule`.

A `decDSA` entry is not permitted immediately beneath the root of the directory information tree.

### A.1.10 decDSAAlias

This object class is used to represent aliases for Compaq DSAs in the DIT.

#### Mandatory Attributes

objectClass  
commonName  
aliasedObjectName

#### Optional Attributes

There are no optional attributes for this class.

#### Naming Rules

The `commonName` attribute must be used for naming.

#### Structure Rules

A directory entry of the object class `decDSAAlias` must have an immediately superior entry of one of the following object classes:

country  
locality  
organization  
organizationalUnit

This is defined in the schema file `DIT.SC` as `decDSAAliasStructureRule`.

A `decDSAAlias` entry is not permitted immediately beneath the root of the directory information tree.

### A.1.11 decALL-IN-1UA

This class represents an ALL-IN-1 user agent. Entries of this class are normally created automatically as a result of a messaging configuration task. This class of entry may have a large number of attributes, but these are normally added as required by messaging configuration. This section does not attempt to document the class fully because you should never need to create such entries manually. Use the `DXIM SHOW SCHEMA CLASS decALL-IN-1UA` command if you need more information, or refer to the schema directly.

### A.1.12 decMailUA

This class represents a mail user agent. Entries of this class are normally created automatically as a result of a messaging configuration task. This class of entry may have a large number of attributes, but these are normally added as required by messaging configuration. This section does not attempt to document the class fully because you should never need to create such entries manually. Use the `DXIM SHOW SCHEMA CLASS decMailUA` command if you need more information, or refer to the schema directly.

### A.1.13 decMailUser

This auxiliary class can be used to enable any entry to have the attributes that support messaging applications such as ALL-IN-1, Office Server, and the MAILbus 400 MTA. Normally this class is added to such entries as a result of messaging configuration tasks, but it can be added manually also.

The attributes permitted for this auxiliary class are usually added as a result of messaging configuration tasks. This section does not attempt to document the class fully because you should never need to use the class manually. Use

## Default Schema Definitions

### A.1 Object Classes

the `DXIM SHOW SCHEMA CLASS decMailUser` command if you need more information, or refer to the schema directly.

#### A.1.14 `decX400Gateway`

This class can be used to represent a MAILbus 400 Message Router Gateway. Normally this class of entry is created as a part of messaging configuration tasks, as documented by the relevant product documentation. This section does not attempt to document the class fully for this reason. Use the `DXIM SHOW SCHEMA CLASS decX400Gateway` command if you need more information, or refer to the schema directly.

#### A.1.15 `device`

`device` entries represent hardware devices.

##### Mandatory Attributes

`objectClass`  
`commonName`

##### Optional Attributes

`description`  
`localityName`  
`organizationName`  
`organizationalUnitName`  
`owner`  
`seeAlso`  
`serialNumber`

##### Naming Rules

The `commonName` attribute must be used for naming.

##### Structure Rules

`device` entries must have an immediately superior entry of one of the following object classes:

`organization`  
`organizationalUnit`  
`locality`

This is defined in the schema file `DIT.SC` as `deviceStructureRule`.

A `device` entry is not permitted immediately beneath the root of the directory information tree.

#### A.1.16 `deviceAlias`

`deviceAlias` entries represent aliases for hardware devices, such as modems or disk drives.

##### Mandatory Attributes

`objectClass`  
`commonName`  
`aliasedObjectName`

##### Optional Attributes

There are no optional attributes for this class.

### Naming Rules

The `commonName` attribute must be used for naming.

### Structure Rules

`deviceAlias` entries must have an immediately superior entry of one of the following object classes:

`organization`  
`organizationalUnit`  
`locality`.

This is defined in the schema file DIT.SC as `deviceAliasStructureRule`.

A `deviceAlias` entry is not permitted immediately beneath the root of the directory information tree.

## A.1.17 dSA

This object class is used to define entries in the DIT that represent Directory System Agents, as defined in ITU-T Recommendation X.501.

---

### Note

---

Compaq DSAs should be represented using the `decDSA` class. Use the `dSA` class to represent non-Compaq DSAs.

---

This object class is a subclass of `applicationEntity` as well as `top`. When you create an entry of this class using the DXIM command line interface, you must specify the `objectClass` as follows:

```
... objectClass=(dSA,applicationEntity)
```

**See also** `applicationEntity` and `decDSA`.

### Mandatory Attributes

`objectClass`  
`commonName`  
`presentationAddress`

### Optional Attributes

`description`  
`knowledgeInformation`  
`localityName`  
`organizationName`  
`organizationalUnitName`  
`seeAlso`  
`supportedApplicationContext`

### Naming Rules

The `commonName` attribute must be used for naming.

## Default Schema Definitions

### A.1 Object Classes

#### Structure Rules

A directory entry of the object class `dsA` must have an immediately superior entry of one of the following object classes:

- `country`
- `locality`
- `organization`
- `organizationalUnit`

This is defined in the schema file `DIT.SC` as `dsAStructureRule`.

A `dsA` entry is not permitted immediately beneath the root of the directory information tree.

#### A.1.18 `dsAAlias`

This object class is used to define aliases for entries in the DIT that represent Directory System Agents, as defined in ITU-T Recommendation X.501.

#### Mandatory Attributes

- `objectClass`
- `commonName`
- `aliasedObjectName`

#### Optional Attributes

There are no optional attributes for this class.

#### Naming Rules

The `commonName` attribute must be used for naming.

#### Structure Rules

A directory entry of the object class `dsAAlias` must have an immediately superior entry of one of the following object classes:

- `country`
- `locality`
- `organization`
- `organizationalUnit`

This is defined in the schema file `DIT.SC` as `dsAAliasStructureRule`.

A `dsAAlias` entry is not permitted immediately beneath the root of the directory information tree.

#### A.1.19 `groupOfNames`

`groupOfNames` entries represent an unordered set of directory names that are grouped for some purpose. Each name represents either an individual entry or is the name of another group.

The group of names can be reduced to a set of individual entry names by replacing each group with its membership. This can be carried out recursively until all constituent group names have been eliminated, and just the names of individual entries remain.

You would create an entry of this object class to describe any set or group of objects that is connected in a significant way, for example, committees, teams, distribution lists, or categories of devices.



**Mandatory Attributes**

objectClass  
commonName  
member

**Optional Attributes**

businessCategory  
description  
organizationName  
organizationalUnitName  
owner  
seeAlso

**Naming Rules**

The `commonName` attribute must be used for naming.

**Structure Rules**

A directory entry of the object class `groupOfNames` must have an immediately superior entry of one of the following object classes:

locality  
organization  
organizationalUnit

This is defined in the schema file DIT.SC as `groupOfNamesStructureRule`.

A `groupOfNames` entry is not permitted immediately beneath the root of the directory information tree.

**A.1.20 groupOfNamesAlias**

`groupOfNamesAlias` entries represent aliases for `groupOfNames` entries.

**Mandatory Attributes**

objectClass  
commonName  
aliasedObjectName

**Optional Attributes**

There are no optional attributes for this class.

**Naming Rules**

The `commonName` attribute must be used for naming.

**Structure Rules**

A directory entry of the object class `groupOfNamesAlias` must have an immediately superior entry of one of the following object classes:

locality  
organization  
organizationalUnit

This is defined in the schema file DIT.SC as `groupOfNamesAliasStructureRule`.

A `groupOfNamesAlias` entry is not permitted immediately beneath the root of the directory information tree.

## Default Schema Definitions

### A.1 Object Classes

#### A.1.21 locality

locality entries represent a geographical locality, such as a state, a province, a city, or a building. You can use locality entries to represent the geographical subdivisions of your organization.

##### Mandatory Attributes

objectClass

##### Optional Attributes

description  
localityName  
stateOrProvinceName  
searchGuide  
seeAlso  
streetAddress

##### Naming Rules

localityName must be used for naming. Therefore, although this attribute is optional according to the class definition, it is in effect mandatory.

##### Structure Rules

A locality entry must have an immediately superior entry that is one of the following object classes:

country  
locality  
organization  
organizationalUnit

This is defined in the schema file DIT.SC as localityStructureRule.

A locality entry is also permitted immediately beneath the root of the directory information tree. This rule is defined in the schema file DIT.SC, and is called localityRootStructureRule.

#### A.1.22 localityAlias

This alias object class is used to define alias entries that represent localities or regions.

##### Mandatory Attributes

objectClass  
aliasedObjectName

##### Optional Attributes

localityName  
stateOrProvinceName

##### Naming Rules

Attribute localityName must be used for naming.

##### Structure Rules

A localityAlias entry must have an immediately superior entry that is one of the following object classes:

country  
locality  
organization  
organizationalUnit

This is defined in DIT.SC as  
`localityAliasStructureRule`.

A `localityAlias` entry can also be immediately beneath the logical root of the DIT. This rule is defined in the schema file DIT.SC, and is called `localityRootAliasStructureRule`.

### A.1.23 `mhs-user`

This auxiliary object class can be used with directory entries to enable them to contain X.400 messaging information.

You can modify any directory entry to add this auxiliary object class. The mandatory attribute of this class then becomes mandatory for the entry.

#### **Mandatory Attributes**

`mhs-or-addresses`

#### **Optional Attributes**

This class has no optional attributes.

#### **Naming Rules**

Auxiliary object classes do not have naming rules. The naming rule of the entry's structural class applies.

#### **Structure Rules**

Auxiliary object classes do not have structure rules. The structure rules of the entry's structural class apply. The `mhs-user` auxiliary class can be added to an entry in any position in the DIT. For example, you can modify an `organizationalPerson` entry to make it a member of the `mhs-user` class. The mandatory attribute of the `mhs-user` class becomes mandatory for the entry.

### A.1.24 `organization`

`organization` entries represent organizations.

Compaq recommends that you create an `organization` entry as the highest entry within your organization's DIT. See Chapter 4 for advice about what classes of entry to use in your organization's DIT.

**See also** `organizationalUnit`.

#### **Mandatory Attributes**

`objectClass`

`organizationName`

#### **Optional Attributes**

`businessCategory`

`description`

`seeAlso`

`searchGuide`

`userPassword`

`localityName`

`stateOrProvinceName`

`streetAddress`

`physicalDeliveryOfficeName`

`postalAddress`

`postalCode`

## Default Schema Definitions

### A.1 Object Classes

postOfficeBox  
streetAddress

destinationIndicator  
facsimileTelephoneNumber  
internationalISDNNumber  
preferredDeliveryMethod  
registeredAddress  
telephoneNumber  
teletexTerminalIdentifier  
telexNumber  
x121Address

#### Naming Rules

organizationName must be used for naming.

#### Structure Rules

An organization entry does not need to have any superior entry. However, if it does, then the immediately superior entry must be of one of the following classes:

country  
locality

This is defined in the schema file DIT.SC as organizationStructureRule.

An organization entry is also permitted immediately beneath the root of the directory information tree. This rule is defined in the schema file DIT.SC, and is called organizationRootStructureRule.

#### A.1.25 organizationAlias

This alias object class is used to define alias entries that represent organizations.

#### Mandatory Attributes

organizationName  
objectClass  
aliasedObjectName

#### Optional Attributes

There are no optional attributes for this class.

#### Naming Rules

Attribute organizationName must be used for naming.

#### Structure Rules

An organizationAlias entry can have an immediately superior entry that is one of the following object classes:

country  
locality  
organization  
organizationalUnit

This is defined in DIT.SC as organizationAliasStructureRule.

An organizationAlias entry can also be immediately beneath the logical root of the DIT. This rule is defined in the schema file DIT.SC, and is called organizationRootAliasStructureRule.

### A.1.26 organizationalPerson

organizationalPerson entries represent people employed by, or associated with, an organization. Compaq recommends that you use the organizationalPerson class as the basis of entries representing your employees.

organizationalPerson is a subclass of person. When you create an entry of this class using the DXIM command line interface, you must specify the objectClass as follows:

```
... objectClass=(organizationalPerson,person)
```

#### Mandatory Attributes

objectClass  
commonName  
surname

#### Optional Attributes

description  
organizationalUnitName  
seeAlso  
telephoneNumber  
title  
userPassword  
  
localityName  
stateOrProvinceName  
streetAddress  
  
physicalDeliveryOfficeName  
postalAddress  
postalCode  
postOfficeBox  
streetAddress  
  
destinationIndicator  
facsimileTelephoneNumber  
internationalISDNNumber  
preferredDeliveryMethod  
registeredAddress  
teletexTerminalIdentifier  
telexNumber  
x121Address

#### Naming Rules

The commonName attribute is used for naming.

#### Structure Rules

organizationalPerson entries must have an immediately superior entry of one of the following object classes:

organization  
organizationalUnit  
locality

This is defined in the schema file DIT.SC as organizationalPersonStructureRule.

## Default Schema Definitions

### A.1 Object Classes

An `organizationalPerson` entry is not permitted immediately beneath the root of the directory information tree.

#### A.1.27 `organizationalPersonAlias`

This alias object class is used to define alias entries that represent people within an organization.

##### Mandatory Attributes

`commonName`  
`objectClass`  
`aliasedObjectName`

##### Optional Attributes

There are no optional attributes for this class.

##### Naming Rules

Attribute `commonName` must be used for naming.

##### Structure Rules

An `organizationalPersonAlias` entry must have an immediately superior entry that is one of the following object classes:

`locality`  
`organization`  
`organizationalUnit`

This is defined in DIT.SC as  
`organizationalPersonAliasStructureRule`.

An `organizationalPersonAlias` entry cannot be immediately beneath the logical root of the DIT.

#### A.1.28 `organizationalRole`

This object class is used to define entries in the DIT that represent a position or a role within an organization. An organizational role is normally considered to be filled by a particular person or a software application, but over its lifetime the role could be filled by many different people or applications in succession.

##### Mandatory Attributes

`objectClass`  
`commonName`

##### Optional Attributes

`description`  
`seeAlso`  
`organizationalUnitName`  
`preferredDeliveryMethod`  
`roleOccupant`

`localityName`  
`stateOrProvinceName`  
`streetAddress`

`physicalDeliveryOfficeName`  
`postalAddress`  
`postalCode`

postOfficeBox  
streetAddress

destinationIndicator  
facsimileTelephoneNumber  
internationalISDNNumber  
preferredDeliveryMethod  
registeredAddress  
telephoneNumber  
teletexTerminalIdentifier  
telexNumber  
x121Address

#### **Naming Rules**

The `commonName` attribute must be used for naming.

#### **Structure Rules**

A directory entry of the object class `organizationalRole` must have an immediately superior entry of one of the following object classes:

`organization`  
`organizationalUnit`

This is defined in the schema file DIT.SC as `organizationalRoleStructureRule`.

An `organizationalRole` entry is not permitted immediately beneath the root of the directory information tree.

### **A.1.29 `organizationalRoleAlias`**

This alias object class is used to define alias entries that represent organizational roles within an organization. For example, the entry might be used to provide an alias for an entry representing a team leader or manager.

#### **Mandatory Attributes**

`commonName`  
`objectClass`  
`aliasedObjectName`

#### **Optional Attributes**

There are no optional attributes for this class.

#### **Naming Rules**

Attribute `commonName` must be used for naming.

#### **Structure Rules**

An `organizationalRoleAlias` entry must have an immediately superior entry that is one of the following object classes:

`locality`  
`organization`  
`organizationalUnit`

This is defined in DIT.SC as `organizationalRoleAliasStructureRule`.

An `organizationalRoleAlias` entry cannot be immediately beneath the logical root of the DIT.

## Default Schema Definitions

### A.1 Object Classes

#### A.1.30 organizationalUnit

organizationalUnit entries represent subdivisions of organizations, such as departments, offices, or branches.

**See also** organization.

##### Mandatory Attributes

objectClass  
organizationalUnitName

##### Optional Attributes

businessCategory  
description  
seeAlso  
searchGuide  
userPassword

localityName  
stateOrProvinceName  
streetAddress

physicalDeliveryOfficeName  
postalAddress  
postalCode  
postOfficeBox  
streetAddress

destinationIndicator  
facsimileTelephoneNumber  
internationalISDNNumber  
preferredDeliveryMethod  
registeredAddress  
telephoneNumber  
teletexTerminalIdentifier  
telexNumber  
x121Address

##### Naming Rules

The organizationalUnitName attribute must be used for naming.

##### Structure Rules

A directory entry of the object class organizationalUnit must have an immediately superior entry of one of the following object classes:

organization  
organizationalUnit  
locality

This is defined in the schema file DIT.SC as organizationalUnitStructureRule.

An organizationalUnit entry is not permitted as an immediate subordinate of the root of the directory information tree.



### A.1.31 organizationalUnitAlias

This alias object class is used to define alias entries that represent organizational units within an organization.

#### Mandatory Attributes

organizationalUnitName  
objectClass  
aliasedObjectName

#### Optional Attributes

There are no optional attributes for this class.

#### Naming Rules

Attribute `organizationalUnitName` must be used for naming.

#### Structure Rules

An `organizationalUnitAlias` entry must have an immediately superior entry that is one of the following object classes:

locality  
organization  
organizationalUnit

This is defined in DIT.SC as `organizationalUnitAliasStructureRule`.

An `organizationalUnitAlias` entry cannot be immediately beneath the logical root of the DIT.

### A.1.32 person

`person` entries represent people. However, note that the default schema does not contain structure rules or a name form for this class, so by default you cannot create entries of this class.

The `person` class is a superclass of the `organizationalPerson` and `residentialPerson` classes. Those two subclasses provide more attributes than the `person` class, and have structure rules and name forms. Compaq recommends that you do not use the `person` class itself.

**See also** `organizationalPerson`, and `residentialPerson`.

#### Mandatory Attributes

objectClass  
commonName  
surname

#### Optional Attributes

description  
seeAlso  
telephoneNumber  
userPassword

#### Naming Rules

The `person` class has no name form and therefore `person` entries cannot be created in the DIT.

See `organizationalPerson` and `residentialPerson` for details of two subclasses of `person`. See Chapter 6 for details of how to define a name form if you want to use the `person` class.

## Default Schema Definitions

### A.1 Object Classes

#### Structure Rules

`person` has no structure rules, and therefore `person` entries cannot be created anywhere in the DIT.

See `organizationalPerson` and `residentialPerson` for details of two structural subclasses of `person`. See Chapter 6 for details of how to define structure rules if you want to use the `person` class.

#### A.1.33 `residentialPerson`

`residentialPerson` entries represent people in the residential environment, such as the resident of a particular address.

`residentialPerson` is a subclass of `person`. When you create an entry of this class using the DXIM command line interface, you must specify the `objectClass` as follows:

```
... objectClass=(residentialPerson,person)
```

**See also** `organizationalPerson` and `person`.

#### Mandatory Attributes

`objectClass`  
`commonName`  
`surname`  
`localityName`

#### Optional Attributes

`businessCategory`  
`description`  
`preferredDeliveryMethod`  
`seeAlso`  
`telephoneNumber`  
`userPassword`

`localityName`  
`stateOrProvinceName`  
`streetAddress`  
`physicalDeliveryOfficeName`  
`postalAddress`  
`postalCode`  
`postOfficeBox`  
`streetAddress`

`destinationIndicator`  
`facsimileTelephoneNumber`  
`internationalISDNNumber`  
`registeredAddress`  
`telephoneNumber`  
`teletexTerminalIdentifier`  
`telexNumber`  
`preferredDeliveryMethod`  
`x121Address`

#### Naming Rules

The `commonName` attribute must be used for naming. You can also use the `streetAddress`.

#### Structure Rules

`residentialPerson` entries must have an immediately superior entry of object class `locality`.

This is defined in the schema file DIT.SC as `residentialPersonStructureRule`.

A `residentialPerson` entry is not permitted immediately beneath the root of the directory information tree.

### A.1.34 `residentialPersonAlias`

This alias object class is used to define alias entries that represent people in a residential or domestic context as the residents of a locality.

#### Mandatory Attributes

`commonName`  
`objectClass`  
`aliasedObjectName`

#### Optional Attributes

`seeAlso`

#### Naming Rules

Attribute `commonName` must be used for naming. The `streetAddress` attribute can be used as an optional second naming attribute.

#### Structure Rules

A `residentialPersonAlias` entry must have an immediately superior entry of the following object class:  
`locality`

This is defined in DIT.SC as  
`residentialPersonAliasStructureRule`.

A `residentialPersonAlias` entry cannot be immediately beneath the logical root of the DIT.

### A.1.35 `shadowingAgreement`

This object class is used by Compaq DSAs to represent an agreement to replicate directory information to or from another Compaq DSA. The shadowing agreement defines the frequency and terms of replication, and enables Compaq DSAs to provide automatic replication, instead of requiring manual intervention.

Note that shadowing agreements are created and managed automatically by Compaq DSAs. Some manual management of these subentries is supported; see Section 8.10.1 for details.

#### Mandatory Attributes

`objectClass`  
`commonName`

## Default Schema Definitions

### A.1 Object Classes

#### Optional Attributes

shadowingAttributes  
shadowingBeginTime  
shadowingEndTime  
shadowingFlags  
shadowingId  
shadowingKnowledgeType  
shadowingLastUpdate  
shadowingMaster  
shadowingNextUpdate  
shadowingPeer  
shadowingReference  
shadowingState  
shadowingUPDFile  
shadowingUPDOffset  
shadowingVersion  
subtreeSpecification

Of these, the only attribute that you should consider managing manually is the *shadowingFlags* attribute. Do not attempt to manage the *shadowingFlags* attribute without referring to Section 8.10.1. Do not modify any of the other attributes of the shadowing agreement.

#### Naming Rules

You must use the `commonName` attribute for naming. Compaq DSAs assign the name of shadowing agreements automatically; do not rename a shadowing agreement subentry.

#### Structure Rules

The `shadowingAgreement` class is a special case. It is created automatically by a Compaq DSA immediately beneath the entry at the top of the naming context to which this shadowing agreement applies. You should not attempt to create these entries manually. If you delete them, replication may fail, or the DSA may automatically recreate the agreement. It is unwise to delete them.

#### A.1.36 subentry

This object class is used as the basis of entries that contain information that the DSA uses to determine how it manages a given part of the DIT.

Further classes are defined as subclasses of `subentry`, to enable the storage of information about one aspect of information management. For example, the `accessControlSubentry` subclass allows for information regarding the control of access to directory information, and the `shadowingAgreement` subclass allows for information about replication agreements.

Note that user requests that can return multiple entries, such as searches, usually exclude subentries. Such commands provide a control that enables you to specify whether you want to see subentries, which are generally of no interest to end users.

#### Mandatory Attributes

objectClass  
commonName

### Optional Attributes

`subtreeSpecification`

### Naming Rules

You must use the `commonName` attribute for naming.

### Structure Rules

The `subentry` class is a special case. It does not have a structure rule like other classes. You can only create an entry of this class beneath an entry that is at the top of a naming context. In practice, you would create an entry based on a subclass of `subentry`, rather than of `subentry` itself.

## A.1.37 top

`top` is an abstract object class.

You do not create entries of class `top` itself. It is a superclass of other object class definitions. This means that other object classes inherit the mandatory attribute `objectClass`.

### Mandatory Attributes

`objectClass`

## A.2 Structure Rules Quick Reference

The illustrations in this section show the structure rules defined in the schema for the structural object classes defined in the schema provided with Compaq Enterprise Directory for eBusiness. (All of these definitions are customizable.)

Figure A-1 shows the permitted relationships between object classes that represent your organization, and its geographical and organizational subdivisions. The illustration also shows that DSA entries can be created as subordinates of a country entry.

## Default Schema Definitions

### A.2 Structure Rules Quick Reference

Figure A-1 Structure Rules for Classes: Part I

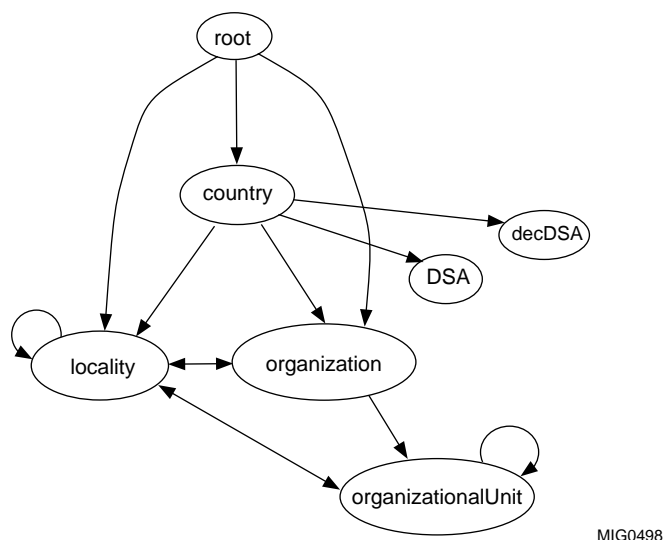

Each arrow represents the ability of an entry of one class to be created as the immediate subordinate of an entry of another class, or beneath the root. For example, a `country` entry can be created immediately beneath the root of the DIT. An `organization` entry can be created beneath the root of the DIT, or beneath a `country` or `locality` entry. Using these classes, you should be able to represent the structure of your organization. Chapter 4 describes in detail how to plan a DIT. Chapter 6 describes how to customize the schema if the default classes and structure rules are not suitable for your organization.

---

#### Note

---

The `dSA` and `decDSA` class are shown as permitted subordinates of `country`. However, you should only represent a `DSA` as an immediate subordinate of a `country` if you are responsible for a national directory service.

For example, a national PTT might be responsible for providing a directory service, and therefore decide to represent one or more `DSAs` in such a position. Most organizations will only be providing a service for their own users, and should therefore create `DSA` entries as subordinates of the `organization` entry, as shown in Figure A-2.

You are recommended to use the `decDSA` class to represent Compaq `DSAs`. You can use this class to represent other vendor's `DSAs` also. The only reason you might use the `dSA` class is if you have other vendors' `DSAs` in your network, and those `DSAs` advise or require that you use the standard `dSA` class to represent them.

Chapter 4 describes in detail the planning of `DSA` entries.

---

Figure A-2 shows the permitted relationships between the classes that represent your organization, and the classes that represent resources within your organization.

Figure A-2 Structure Rules for Classes: Part II

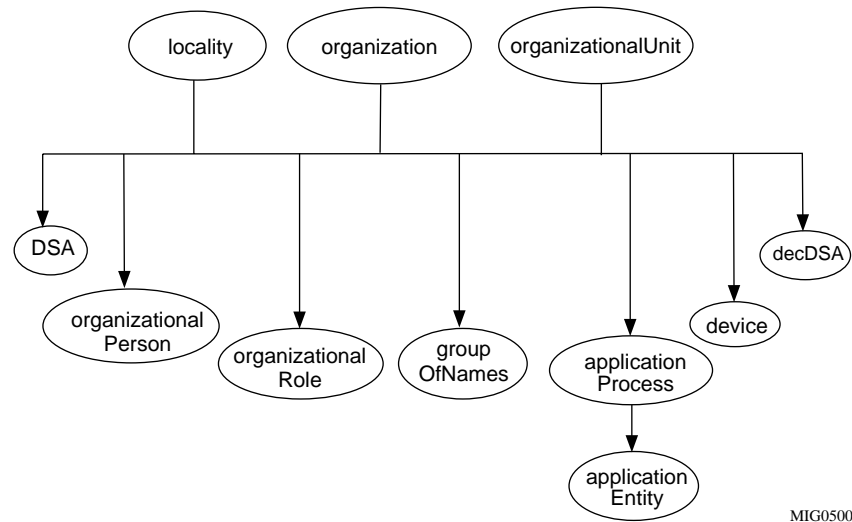

MIG0500

The default schema provided with the product specifies that all of the classes that represent resources are permitted beneath any of the classes that you use to represent your organizational structure. If you define a class to represent a resource for which none of the default classes are suitable, then you probably need to make it a permitted subordinate of all three of **locality**, **organization**, and **organizationalUnit**, like all of the classes shown at the bottom of Figure A-2.

The schema provided with the product also contains several alias classes. Each alias class is designed to mimic one of the structural classes. Therefore, each alias class has structure rules that permit entries to be created in the same DIT positions as the entries they mimic. For example, a **countryAlias** entry can be created beneath the root of the DIT, just as a **country** entry can. Similarly, an **organizationAlias** entry can be created beneath the root, or beneath a **country** or **locality** entry.

Note that an alias entry cannot have subordinate entries. For example, you cannot create a **localityAlias** entry beneath a **countryAlias** entry, because a **countryAlias** entry cannot have subordinates.

### A.3 Attributes

The following topics each describe an attribute defined in the default schema. Each attribute definition specifies an attribute syntax, and may specify that the attribute can have more than one value. The schema also contains labels for each attribute. A label specifies permitted abbreviations or user-friendly alternatives for an attribute. These labels are used by DXIM to improve the usability of the utility.

Not all of the attributes in the default schema are documented. Specifically, attributes defined in **COSINE.SC** and **QUIPU.SC** are only likely to be relevant if you interwork with those implementations. In that case, refer to the documentation provided with those implementations.

## Default Schema Definitions

### A.3 Attributes

Some of the attributes described are ***operational attributes***. An operational attribute is usually hidden from users, and is often managed automatically by the DSA. A small number of operational attributes are managed manually, such as the `trustedDSAName` and `prescriptiveACI` attributes. However, most operational attributes are read-only.

To display operational attributes, you can use the DXIM command line interface with the *all operational attributes* control, or request an attribute specifically. For example:

```
dxim> show /C=US/O=Abacus/OU=Sales all operational attributes
```

The DXIM windows interface does not support the display or management of operational attributes.

Because most operational attributes are read-only, the sections describing those attributes may be less detailed than the descriptions of other attributes.

#### A.3.1 administrativeRole

This is an operational attribute. Compaq DSAs do not use this attribute.

The attribute is intended to be created on an entry that represents the root of an administrative area of the DIT. The values of the attribute are intended to indicate what classes of subentry may be created beneath the entry. The subentries would specify information about the administrative area. Do not use this attribute unless you have DSAs that support it.

The syntax for this attribute is `objectIdentifierSyntax`.

#### A.3.2 aliasedObjectName

Every alias entry has an `aliasedObjectName` attribute. The attribute specifies the name of the directory entry for which this alias entry provides an alias name.

##### Attribute Syntax

The syntax for this attribute type is `distinguishedNameSyntax`.

For example:

```
aliasedObjectName="/C=US/O=Abacus/OU=Sales"
```

The value of this attribute should be the distinguished name of an entry in the DIT. The Enterprise Directory does not verify that the distinguished name actually exists in the DIT until a user tries to use the alias name. If the alias name does not resolve to the distinguished name of an entry, the Enterprise Directory returns an error.

---

##### Note

---

Do not specify the name of another alias entry as the value of the `aliasedObjectName` attribute. If the name specified in the `aliasedObjectName` attribute is actually an alias name, then the Enterprise Directory returns an error.

---



**Labels**

`aliasedObjectName`

For example:

`aliasedObjectName=/c=US/o=ACME`

**A.3.3 businessCategory**

This specifies information concerning the occupation or field of interest of an object such as a person or organization.

A business category can be up to 128 characters long.

**Attribute Syntax**

The syntax for this attribute type is `stringSyntax`, for example, `businessCategory="Retail"`. This attribute specifies that it supports matching rules that are not case sensitive.

**Labels**

`businessCategory`

For example:

`businessCategory=Retail`

**A.3.4 commonName**

This specifies a name by which an object is usually known. For example, the common name of a person might be John Smith.

A common name should follow the conventions of the culture of the object represented. For example, you can use characters such as ö, à, é, and ß if they usually form part of a name for an object. Similarly, a person's family name may be placed first or last, according to the conventions usually applied to that person's name.

A common name can be up to 64 characters long.

**Attribute Syntax**

The syntax for this attribute type is `stringSyntax`, for example, `commonName="John Smith"`. This attribute specifies that it supports matching rules that are not case sensitive.

For example, a search for `commonName="John Smith"` would succeed in finding an entry called `commonName="john smith"`.

**Labels**

`cn`

`common`

`name`

`commonName`

For example:

`cn="John Smith"`

## Default Schema Definitions

### A.3 Attributes

#### A.3.5 consumerKnowledge

This is an operational attribute. Compaq DSAs use this attribute to store information about the replication of information.

Do not modify this attribute manually. The DSA manages the attribute automatically.

A Compaq DSA adds this operational attribute to the entry at the top of a naming context that is replicated from this DSA to other DSAs.

You can use the DXIM command line interface to display this attribute if you request the attribute specifically. However, it will not be displayed in a user-friendly format. DXIM does not display operational attributes if you use the All Attributes control.

You cannot display this attribute using the DXIM windows interface.

See also the `supplierKnowledge` attribute. See Chapter 5 for details of consumer DSAs and supplier DSAs.

#### A.3.6 countryName

This specifies the international code that represents a country's name.

The list of codes supported by the Compaq DSA is as follows:

```
AD AE AF AG AI AL AM AN AO AQ AR AS AT AU AW AZ BA BB BD BE
BF BG BH BI BJ BM BN BO BR BS BT BV BW BY BZ CA CC CF CG CH
CI CK CL CM CN CO CR CU CV CX CY CZ DE DJ DK DM DO DZ EC EE
EG EH ER ES ET FI FJ FK FM FO FR FX GA GB GD GE GF GH GI GL
GM GN GP GQ GR GS GT GU GW GY HK HM HN HR HT HU ID IE IL IN
IO IQ IR IS IT JM JO JP KE KG KH KI KM KN KP KR KW KY KZ LA
LB LC LI LK LR LS LT LU LV LY MA MC MD MG MH MK ML MM MN MO
MP MQ MR MS MT MU MV MW MX MY MZ NA NC NE NF NG NI NL NO NP
NR NU NZ OM PA PE PF PG PH PK PL PM PN PR PT PW PY QA RE RO
RU RW SA SB SC SD SE SG SH SI SJ SK SL SM SN SO SR ST SV SY
SZ TC TD TF TG TH TJ TK TM TN TO TP TR TT TV TW TZ UA UG UM
US UY UZ VA VC VE VG VI VN VU WF WS YE YT YU ZA ZM ZR ZW
```

##### Attribute Syntax

The value of the `countryName` attribute must be a two-letter code chosen from International Standard 3166. For example, the value `US` is the correct code for the United States of America.

It does not matter whether the country code is specified in uppercase or lowercase.

##### Labels

```
c
co
country
countryname
```

For example:

```
c=US
```

### A.3.7 createTimeStamp

This is an operational attribute. Compaq DSAs use this attribute to record the time that an entry was created.

Compaq DSAs add this operational attribute to each entry. Do not modify this attribute manually. You can use the DXIM command line interface to display this attribute if you request the attribute specifically. DXIM does not display operational attributes if you use the All Attributes control.

You cannot display this attribute using the DXIM windows interface.

The syntax of this attribute is `generalizedTimeSyntax`.

See also `modifyTimeStamp`.

### A.3.8 decALL-IN-1UName

This attribute represents the name of the ALL-IN-1 user agent for a user.

#### Attribute Syntax

The syntax for this attribute type is `distinguishedNameSyntax`.

#### Labels

`decALL-IN-1UName`

For example:

```
decALL-IN-1UName="/C=US/O=Abacus/CN=A1"
```

### A.3.9 decALL-IN-1UserName

This attribute represents the ALL-IN-1 user name of a user.

#### Attribute Syntax

The syntax for this attribute type is `stringSyntax`.

#### Labels

`decALL-IN-1UserName`

For example:

```
decALL-IN-1UserName=HOLMESJ
```

### A.3.10 decAltMRAddress

This attribute represents alternative Message Router addresses. The alternative address might be used by a Message Router gateway when it needs to translate from one style of address to another.

#### Attribute Syntax

The syntax for this attribute type is `stringSyntax`.

#### Labels

`decAltMRAddress`

For example:

```
decAltMRAddress="colin jones@SALES"
```

## Default Schema Definitions

### A.3 Attributes

#### A.3.11 decAltRFC822Mailbox

This attribute represents alternative SMTP addresses. The attribute might be used by a gateway when it needs to translate from one style of address to another.

##### Attribute Syntax

The syntax for this attribute type is `ia5StringSyntax`.

##### Labels

`decAltRFC822Mailbox`

For example:

```
decAltRFC822Mailbox="jones@abacus.com"
```

#### A.3.12 decDDSID

This attribute enables a MAILbus Directory Service entry to be synchronised with an X.500 entry. Do not modify this attribute.

#### A.3.13 decDDSMModificationTimestamp

This attribute enables a MAILbus Directory Service entry to be synchronised with an X.500 entry. Do not modify this attribute.

#### A.3.14 decDDSNetworkID

This attribute enables a MAILbus Directory Service entry to be synchronised with an X.500 entry. Do not modify this attribute.

#### A.3.15 decDECnetNodeName

This attribute represents the name of the DECnet node at which a user agent or application services DECnet requests.

##### Attribute Syntax

The syntax for this attribute type is `ia5StringSyntax`.

##### Labels

`decDECnetNodeName`

For example:

```
decDECnetNodeName=MYNODE
```

#### A.3.16 decGlobalSearchBase

This attribute defines a search base that might be supported by user agents. A user agent might present its users with the options of "global" searches and "local" searches. The user agent can determine what search base to use for global searches by referring to this attribute.

##### Attribute Syntax

The syntax for this attribute type is `distinguishedNameSyntax`.

##### Labels

`decGlobalSearchBase`

For example:

```
decGlobalSearchBase="/C=US/O=Abacus"
```

### A.3.17 decLocalSearchBase

This attribute defines a search base that might be supported by user agents. A user agent might present its users with the options of "global" searches and "local" searches. The user agent can determine what search base to use for local searches by referring to this attribute.

#### Attribute Syntax

The syntax for this attribute type is `distinguishedNameSyntax`.

#### Labels

`decLocalSearchBase`

For example:

```
decLocalSearchBase="/C=US/O=Abacus/CN=Sales"
```

### A.3.18 decMailDestination

This attribute represents the name of a mail destination for a user.

#### Attribute Syntax

The syntax for this attribute type is `distinguishedNameSyntax`.

#### Labels

`decMailDestination`

For example:

```
decMailDestination="/C=US/O=Abacus/CN=A1"
```

### A.3.19 decMailNonDeliver

This attribute indicates that mail for the user should be non-delivered. The value of the attribute may be used as part of the non-delivery notification.

#### Attribute Syntax

The syntax for this attribute type is `printableStringSyntax`.

#### Labels

`decMailNonDeliver`

For example:

```
decMailNonDeliver="This user has left the company"
```

### A.3.20 decMailworksUserName

This attribute represents the local user name for a DEC MAILworks user.

#### Attribute Syntax

The syntax for this attribute type is `stringSyntax`.

#### Labels

`decMAILworksUserName`

For example:

```
decMAILworksUserName=Hubbard
```

## Default Schema Definitions

### A.3 Attributes

#### A.3.21 decMRAddress

This attribute represents the Message Router address of a user.

##### Attribute Syntax

The syntax for this attribute type is `stringSyntax`.

##### Labels

`decMRAddress`

For example:

```
decMRAddress="colin jones@SALES"
```

#### A.3.22 decMTSAltForeignAddressAttr

##### Attribute Syntax

The syntax for this attribute type is `objectIdentifierSyntax`.

##### Labels

`decMTSAltForeignAddr`

For example:

```
decMTSAltForeignAddr={2 5 10}
```

#### A.3.23 decMTSDDAType

##### Attribute Syntax

The syntax for this attribute type is `printableStringSyntax`. The value length is limited to eight characters.

##### Labels

`decMTSDDAType`

For example:

```
decMTSDDAType="XMRROUTE"
```

#### A.3.24 decMTSForeignAddressAttr

This attribute identifies an attribute type that a mail gateway might use when mapping between different styles of address. The attribute is identified by its object identifier.

##### Attribute Syntax

The syntax for this attribute type is `objectIdentifierSyntax`.

##### Labels

`decMTSForeignAddressAttr`

For example:

```
decMTSForeignAddressAttr={2 5 98}
```

### A.3.25 dec-mts-admd-name

This attribute is used in the MAILbus 400 MTA's routing information subtree to name an administration domain.

### A.3.26 dec-mts-prmd-name

This attribute is used in the MAILbus 400 MTA's routing information subtree to name a private administration domain.

### A.3.27 dec-mts-talk-other-CCITT-domain

This attribute is used in the MAILbus 400 MTA's routing information subtree to indicate whether a user is permitted to send mail across domain boundaries.

### A.3.28 decNumericUserId

This attribute represents a numeric identifier for a user. The identifier may form part of a numeric OR address for the user.

#### Attribute Syntax

The syntax for this attribute type is `numericStringSyntax`.

#### Labels

`decNumericID`

For example:

`decNumericID=2328461`

### A.3.29 decOVVMAddress

This attribute represents the IBM OfficeVision address of a user. It should be in the form `LOCATION.USERNAME`.

#### Attribute Syntax

The syntax for this attribute type is `stringSyntax`.

#### Labels

`decOVVMAddress`

For example:

`decOVVMAddress="LONDON.SMITH"`

### A.3.30 decPMAAddress

This attribute represents a MAILbus Postmaster address.

#### Attribute Syntax

The syntax for this attribute type is `stringSyntax`.

#### Labels

`decPMAAddress`

For example:

`decPMAAddress="postmaster@A1"`

## Default Schema Definitions

### A.3 Attributes

#### A.3.31 decPreferredMailAddress

This attribute identifies the type of attribute that contains the preferred mail address of a user. For example, it might indicate that the `mhs-or-address` attribute contains the preferred address. The attribute is identified by its object identifier.

##### Attribute Syntax

The syntax for this attribute type is `objectIdentifierSyntax`.

##### Labels

`decPreferredMailAddress`

For example:

```
decPreferredMailAddress={2 5 28}
```

#### A.3.32 decSNADSAddress

This attribute represents the IBM SNADS address of a user. It should be in the form `LOCATION.USER`.

##### Attribute Syntax

The syntax for this attribute type is `stringSyntax`.

##### Labels

`decSNADSAddress`

For example:

```
decSNADSAddress="LONDON.JONES"
```

#### A.3.33 decX400DDA

This attribute represents the domain-defined attribute of a user's X.400 OR address. The attribute is a string list, with the first list item indicating the DDA attribute type, and the second list item specifying the value.

##### Attribute Syntax

The syntax for this attribute type is `stringListSyntax`.

##### Labels

`decX400DDA`

For example:

```
decX400DDA="smith(a)A1(a)node6"
```

#### A.3.34 decX400MRGatewayName

This attribute represents the name of a MAILbus 400 Message Router Gateway used by a user agent.

##### Attribute Syntax

The syntax for this attribute type is `distinguishedNameSyntax`.

##### Labels

`decX400MRGatewayName`

For example:

```
decX400MRGatewayName="/C=US/O=Abacus/CN=XMR"
```



### A.3.35 decX400SMTPGatewayName

This attribute represents the name of the MAILbus 400 SMTP Gateway used by a user agent.

#### Attribute Syntax

The syntax for this attribute type is `distinguishedNameSyntax`.

#### Labels

`decX400SMTPGatewayName`

For example:

```
decX400SMTPGatewayName="/C=US/O=Abacus/CN=STMP
```

### A.3.36 decX400Redirect

This attribute represents the X.400 OR address to which messages should be redirected.

#### Attribute Syntax

The syntax for this attribute type is `mhs-or-name-syntax`.

#### Labels

`decX400Redirect`

For example:

```
decX400Redirect="C=US;A=XYZ;P=Abacus;O=Abacus;OU1=Sales;CN=John Smith
```

### A.3.37 description

Use the `description` attribute to provide descriptive information about an object. The description can be up to 1024 characters long.

#### Attribute Syntax

The syntax for this attribute type is `stringsyntax`. For example, an entry representing a distribution list could have the associated description, "distribution list for sales figures, forecasts, and quarterly reports".

This attribute specifies it supports matching rules that are not case sensitive. For example, `description=BIG` matches `description=Big`.

#### Labels

`description`

For example:

```
description=Big
```

### A.3.38 destinationIndicator

Specifies the country and city associated with the named object, the addressee, required to provide the Public Telegram Service, according to CCITT Recommendations F.1 and F.3.

#### Attribute Syntax

The syntax for this attribute type is a string of alphabetical characters from the `printableString` character set.

## Default Schema Definitions

### A.3 Attributes

#### Labels

dest  
destinationIndicator  
destIndicator

For example:

dest=abc

#### A.3.39 dseType

This is an operational attribute. Compaq DSAs use this attribute on every entry to record the type of each entry.

For example, the `dseType` attribute indicates whether an entry is an alias entry, and whether it is a shadow copy of an entry held by another DSA. The attribute also indicates whether an entry is at the top of a naming context, or contains subordinate reference information.

The DSA adds this operational attribute to every entry. Do not modify this attribute manually.

You can use the DXIM command line interface to display this attribute if you request the attribute specifically. DXIM does not display operational attributes if you use the All Attributes control.

You cannot display this attribute using the DXIM windows interface.

#### A.3.40 dxdUid

This is an operational attribute. Compaq DSAs use this attribute to uniquely identify each entry.

The DSA adds this operational attribute to every entry. Do not modify this attribute manually.

You can use the DXIM command line interface to display this attribute if you request the attribute specifically. DXIM does not display operational attributes if you use the All Attributes control.

You cannot display this attribute using the DXIM windows interface.

#### A.3.41 facsimileTelephoneNumber

Specifies a telephone number for a facsimile terminal associated with the named object.

#### Attribute Syntax

The syntax for this attribute type is a string of numeric characters from the `printableString` character set. The standard format for facsimile telephone numbers should include some optional G3 Facsimiletex Non Basic Parameters. However, Compaq DSAs do not support the optional parameters, so in effect, this attribute is the same as the `telephoneNumber` attribute, if you are using Compaq DSAs.

#### Labels

faxno  
faxtelephonenumber  
facsimiletelephonenumber  
fax

For example:

```
faxno="+81 3 347 9999"
```

#### A.3.42 generationQualifier

Specifies the generation qualifier of a person. For example, you could use this attribute to specify "Senior", "Junior", or "III".

A generation qualifier can be up to 64 characters long.

##### Attribute Syntax

The syntax for this attribute type is **stringSyntax**, for example, **generationQualifier=Junior**. This attribute specifies that it supports matching rules that are not case sensitive.

For example, a search for **generationQualifier=Junior** would succeed in finding an entry with **generationQualifier=junior**.

##### Labels

**generationQualifier**

For example:

```
generationQualifier=Junior
```

#### A.3.43 givenName

Specifies a given name.

A given name should follow the conventions of the culture of the object represented. For example, you can use characters such as ö, à, é, and ß if they usually form part of a name for an object.

A common name can be up to 64 characters long.

##### Attribute Syntax

The syntax for this attribute type is **stringSyntax**, for example, **givenName=John**. This attribute specifies that it supports matching rules that are not case sensitive.

For example, a search for **givenName=John** would succeed in finding an entry with **givenName=john**.

##### Labels

**givenName**

For example:

```
givenName=John
```

#### A.3.44 governingStructureRule

This is an operational attribute. Compaq DSAs use this attribute to specify which structure rule was used when an entry was created. For example, if you create a **locality** entry beneath a **country** entry, the DSA automatically specifies a different value than if you create a **locality** entry beneath an **organization** entry.

The DSA adds this operational attribute to every entry. Do not modify this attribute manually.

You can use the DXIM command line interface to display this attribute if you request the attribute specifically. DXIM does not display operational attributes if you use the All Attributes control.

You cannot display this attribute using the DXIM windows interface.

## Default Schema Definitions

### A.3 Attributes

#### A.3.45 initials

Specifies the initials of a person's names.

For example, a person called John Irvin Scott might have an initials attribute with the value J.I. If you use periods (.) to punctuate the initials, you must quote the value. For example, `initials="J.I."`.

##### Attribute Syntax

The syntax for this attribute type is `stringSyntax`. This attribute specifies that it supports matching rules that are not case sensitive.

##### Labels

`initials`

For example:

```
initials="J.I."
```

#### A.3.46 internationalISDNNumber

Specifies an International ISDN Number associated with the named object.

An international ISDN number can be up to 16 characters long.

##### Attribute Syntax

The syntax for this attribute type is `numericStringSyntax`, and should comply with the internationally agreed format for ISDN addresses, CCITT Recommendation E.164.

##### Labels

`ISDNno`

`internationalISDNnumber`

For example:

```
ISDNno=12344321
```

#### A.3.47 knowledgeInformation

Specifies a human-readable description of knowledge contained in a specific DSA. This knowledge relates to the location of DSAs and the information they contain.

Note that Compaq DSAs do not use this attribute for any operations.

##### Attribute Syntax

The syntax for this attribute type is `stringSyntax`. This attribute specifies that it supports matching rules that are not case sensitive.

##### Labels

`ki`

`knowledgeInformation`

For example:

```
ki="/c=FR/o=Reveco"
```

### A.3.48 lastUpdateReceived

This is an operational attribute. Compaq DSAs use this attribute to record the time that a given naming context was most recently updated by replication.

The DSA adds this operational attribute to the entry at the top of a replicated naming context. Do not modify this attribute manually.

You can use the DXIM command line interface to display this attribute if you request the attribute specifically. DXIM does not display operational attributes if you use the All Attributes control.

You cannot display this attribute using the DXIM windows interface.

### A.3.49 localityName

Specifies the name of a locality or region, such as a city or county. A locality name can be up to 128 characters long.

#### Attribute Syntax

The syntax for this attribute type is `stringSyntax`, for example, `localityName="New York"`. This attribute specifies that it supports matching rules that are not case sensitive. For example, `localityName="New York"` matches `localityName="new york"`.

#### Labels

l  
loc  
locality  
localityName

For example:

```
l="New York"
```

### A.3.50 member

Specifies a name or names associated with the entry of which this is an attribute. For example, an entry representing a committee could have a `member` attribute containing the names of the committee members.

Note that there is no connection between a directory entry and any `member` attributes that specify that entry's distinguished name. For example, if you delete an entry or rename it, the `member` attribute is not updated.

#### Attribute Syntax

The syntax for this attribute type is `distinguishedNameSyntax`. Each distinguished name should be the name of a directory entry.

#### Labels

member

For example:

```
member="/c=FR/o=Reco/cn="Per Lebrun"
```

### A.3.51 mhs-or-addresses

Specifies an X.400 messaging originator/recipient address.

## Default Schema Definitions

### A.3 Attributes

#### Attribute Syntax

The syntax for this attribute type is `mhs-or-address-syntax`.

For example:

```
mhs-or-address="C=US; A=Admin; P=Abacus; G=David; S=Townsend; OU1=Sales"
```

#### Labels

```
mhs-or-addresses  
ORAddress  
X400address  
mhsORAddresses
```

For example:

```
ORAddress="C=US; A=Admin; P=Abacus; G=David; S=Townsend; OU1=Sales"
```

#### A.3.52 modifyTimeStamp

This is an operational attribute. Compaq DSAs use this attribute to record the time that an entry was most recently modified.

The DSA adds this operational attribute to each entry that is modified. Do not modify this attribute manually.

You can use the DXIM command line interface to display this attribute if you request the attribute specifically. DXIM does not display operational attributes if you use the All Attributes control.

You cannot display this attribute using the DXIM windows interface.

See also `createTimeStamp`.

#### A.3.53 myAccessPoint

This is an operational attribute. Compaq DSAs use this attribute to store their own network access points.

Do not modify this attribute manually

You can use the DXIM command line interface to display this attribute if you request the attribute specifically. DXIM does not display operational attributes if you use the All Attributes control.

You cannot display this attribute using the DXIM windows interface.

#### A.3.54 objectClass

Specifies the object class and superclasses of the entry of which this is an attribute. This attribute must be present in every directory entry so that the Enterprise Directory knows what rules to apply to an entry.

#### Attribute Syntax

The syntax for this attribute type is `objectIdentifierSyntax`, for example, `{2 5 6 1}`. DXIM uses user-friendly labels for input and output purposes, rather than object identifiers. For example, DXIM displays and allows you to use the label `organization` rather than its object identifier.

**Labels**

class  
objectClass

For example:

class=organization

**A.3.55 organizationName**

Specifies the name of an organization.

Attribute values for the `organizationName` attribute are strings chosen by the organization.

An organization name can be up to 64 characters long.

**Attribute Syntax**

The syntax for this attribute type is `stringSyntax`, for example, `organizationName="Acme Shoe Company"`. This attribute specifies that it supports matching rules that are not case sensitive. For example, `organizationName="Acme Shoe Company"` matches `organizationName="ACME shoe company"`.

**Labels**

o  
orgname  
organizationName  
organisationName

For example:

o="ACME Shoe Company".

**A.3.56 organizationalUnitName**

Specifies the name of an organizational unit, such as a team, group, department, or committee.

This attribute can be used to name an entry, for example, an entry that represents a committee. It can also be used within an entry as background information, for example, a person entry could include an `organizationalUnitName` attribute that specifies what team they work for.

An organizational unit name can be up to 64 characters long.

**Attribute Syntax**

The syntax for this attribute type is `stringSyntax`, for example, `organizationalUnitName=Sales`. This attribute specifies that it supports matching rules that are not case sensitive. For example, `organizationalUnitName=Sales` matches `organizationalUnitName=sales`.

**Labels**

ou  
orgunitname  
organizationalUnitName  
organisationalUnitName  
ouname

For example:

ou=sales

## Default Schema Definitions

### A.3 Attributes

#### A.3.57 owner

Specifies the name of the owner of the object represented by the entry that contains this attribute.

For example, an entry representing a computer could have an **owner** attribute which specifies the name of its system manager.

##### Attribute Syntax

The syntax for this attribute type is **distinguishedNameSyntax**. The distinguished name should be the name of a directory entry.

##### Labels

**owner**

For example:

```
owner="/c=NZ/o=THKS/cn=Jerry Thomson"
```

#### A.3.58 physicalDeliveryOfficeName

Specifies the name of the city, town, or village where the physical delivery office is situated.

An office name can be up to 128 characters long.

##### Attribute Syntax

The syntax for this attribute type is **stringSyntax**. For example, **physicalDeliveryOfficeName="Hartman House"**. This attribute specifies that it supports matching rules that are not case sensitive. For example, **physicalDeliveryOfficeName="Hartman House"** matches **physicalDeliveryOfficeName="hartman house"**.

##### Labels

**pdoff**

**physicalDeliveryOfficeName**

**pdoffname**

For example:

```
pdoff=Auckland
```

**See also** **postalAddress**, **postalCode**, and **postOfficeBox**.

#### A.3.59 postalAddress

Specifies the address information required for the physical delivery of postal messages by the postal authority of the named object.

An attribute value is limited to a maximum of 6 lines with no more than 30 characters each. The information contained in this address normally includes an addressee's name, street address, city, state or province name, and a postal code. A Post Office Box number could also be included.

##### Attribute Syntax

The syntax for this attribute type is **postalAddressSyntax**. Each line of the postal address is either a printable string or a T.61 string. Each line of the address ends with a comma.

If you want a particular line to actually contain a comma, then use the single quotation marks to enclose that particular line.



**Labels**

postaddr  
postaladdress  
postaddress

For example: `postaddr="F.Burn, 3 Oak St, Bram, OHIO"`

The above example is an address containing four lines. The value is quoted, to clarify that this is one value. The following example is an address containing four lines, where the second line contains a comma:

`postaddr="F.Burn, '3, Oak St', Bram, OHIO"`

If '3, Oak St' were not quoted, DXIM would treat the address as having five lines because of the presence of the comma after the "3" character. The quotes clarify that that comma is part of the value, rather than a separator between values.

**See also** `postalCode`, `physicalDeliveryOfficeName`, and `postOfficeBox`.

**A.3.60 postalCode**

Specifies a postal code or zip code. If this attribute value is present, then it forms part of the object's postal address.

A postal code can be up to 40 characters long.

**Attribute Syntax**

The syntax for this attribute type is `stringSyntax`, for example, `postalCode="PO21 4TG"`. This attribute specifies that it supports matching rules that are not case sensitive. For example, `postalCode="PO21 4TG"` matches `postalCode="po21 4tg"`.

**Labels**

postcode  
postalcode

For example:

`postcode="PO21 4TG"`

**See also** `postalAddress`, `physicalDeliveryOfficeName`, and `postOfficeBox`.

**A.3.61 postOfficeBox**

Specifies the Post Office Box by which the object receives physical postal delivery. If this attribute value is present, then it is part of the object's postal address.

A post office box can be up to 40 characters long.

**Attribute Syntax**

The syntax for this attribute type is `stringSyntax`, for example, `postOfficeBox="PO Box 13"`. This attribute specifies that it supports matching rules that are not case sensitive. For example, `postOfficeBox="PO BOX 13"` matches `postOfficeBox="po box 13"`.

**Labels**

PObox  
postofficebox  
postbox

For example:

`PObox="PO box 13"`

## Default Schema Definitions

### A.3 Attributes

See also `postalAddress`, `postalCode`, and `physicalDeliveryOfficeName`.

#### A.3.62 `preferredDeliveryMethod`

Specifies preferred methods of physical message delivery. The attribute can be multivalued, with the most preferred method of delivery being the first value.

A preferred delivery method value can be up to 9 characters long.

##### Attribute Syntax

The syntax for this attribute type is a sequence of single-digit integer values, for example, "3, 4, 1, 8". These values correspond to the different delivery methods as follows:

- 0 refers to any-delivery-method.
- 1 refers to mhs-delivery.
- 2 refers to physical-delivery.
- 3 refers to telex-delivery.
- 4 refers to teletex-delivery.
- 5 refers to g3-facsimile-delivery.
- 6 refers to g4-facsimile-delivery.
- 7 refers to ia5-terminal-delivery.
- 8 refers to videotex-delivery.
- 9 refers to telephone-delivery.

##### Labels

`prefdel`  
`preferredDeliveryMethod`  
`pdm`

For example:

`prefdel=0`

See also `facsimileTelephoneNumber`, `postalAddress`, `telephoneNumber`, `telexNumber`, and `teletexTerminalIdentifier`.

#### A.3.63 `prescriptiveACI`

Specifies the access controls to be applied to all entries in a given naming context. See Chapter 7 for further details of Compaq's support of prescriptive access controls.

##### Labels

`paci`  
`prescriptiveACI`

##### Attribute Syntax

The syntax for this attribute type is the `aciSyntax`.

#### A.3.64 `presentationAddress`

Specifies a network presentation address.

##### Attribute Syntax

The syntax for this attribute type is four strings which correspond to the following elements of the presentation address:

- A presentation selector
- A session selector
- A transport selector

A network address

For full details of the syntax of a presentation address see Section A.3.64.1.

### Labels

presentationaddress  
paddr

For example:

```
presentationaddress='A"/"B"/"C"/NS+49000000000000000000'
```

where "A" is the presentation selector, "B" is the session selector, "C" is the transport selector, and NS+49000000000000000000 is the network address.

#### A.3.64.1 Further Syntax Details

The full syntax of the presentationAddress attribute is as follows.

Note that the numbers 1 to 12 shown to the right of this syntax description are not part of the syntax. They refer to explanations which are provided at the end of this syntax description.

```
<presentation-address> ::= [[ <psel> "/" ] <ssel> "/" ]
                           <tssel> "/" ] <network-address-list>

<psel>           ::= <selector>

<ssel>           ::= <selector>

<tssel>          ::= <selector>

<selector>       ::= "' ' <otherstring> ' '           1
                   | "#" <digitstring>             2
                   | "' ' <hexstring> "'H"
                   | ""

<network-address-list> ::= <network-addr> [ "|" <network-addr> ]
                           | <network-addr>

<network-addr> ::= <network-address> [ "," <network-type> ]

<network-type> ::= "CLNS" | "CONS" | "RFC1006"       3

<network-address> ::= "NS" "+" <dohexstring>        4
                   | <afi> "+" <idi> ["+" <dsp>]
                   | <idp> "+" <hexstring>          5
                   | RFC1006 "+" <ip> ["+" <port>]  6

<idp>            ::= <digitstring>

<dsp>            ::= "d" <digitstring>              7
                   | "x" <dohexstring>             8
                   | "l" <otherstring>             9
                   | "RFC1006" "+" <prefix> "+" <ip> ["+" <port>
                   | "+" <tset>]]
                   | "X.25(80)" "+" <prefix> "+" <dte>
                   | "+" <cudf-or-pid> "+" <hexstring> ]
                   | "ECMA-117-Binary"
                   | "+" <hexstring> "+" <hexstring>
                   | "+" <hexstring>
                   | "ECMA-117-Decimal"
                   | "+" <digitstring> "+" <digitstring>
                   | "+" <digitstring>
```

## Default Schema Definitions

### A.3 Attributes

```
<idi> ::= <digitstring>

<afi> ::= "X121" | "DCC" | "TELEX" | "PSTN"
        | "ISDN" | "ICD" | "LOCAL"

<prefix> ::= <digit> <digit>

<ip> ::= <domainstring> 10

<port> ::= <digitstring> 11

<tset> ::= "TCP" | "IP" | <digitstring> 12

<dte> ::= <digitstring>
<cudf-or-pid> ::= "CUDF" | "PID"

<decimaloctet> ::= <digit> | <digit> <digit>
                  | <digit> <digit> <digit>
<digit> ::= [0-9]

<digitstring> ::= <digit> <digitstring>
                  | <digit>

<domainchar> ::= [0-9a-zA-Z-.]

<domainstring> ::= <domainchar> <otherstring>
                  | <domainchar>

<dotstring> ::= <decimaloctet> "." <dotstring>
               | <decimaloctet> "." <decimaloctet>

<dothexstring> ::= <dotstring>
                  | <hexstring>

<hexdigit>:: ::= [0-9a-fA-F]

<hexoctet> ::= <hexdigit> <hexdigit>

<hexstring> ::= <hexoctet> <hexstring>
               | <hexoctet>

<other> ::= [0-9a-zA-Z+-.]

<otherstring> ::= <other> <otherstring>
                | <other>
```

- 1 Value restricted to printed characters
- 2 US GOSIP requirement
- 3 Network type identifier (the default is CLNS)
- 4 Concrete binary representation of network (NSAP) address value
- 5 ISO 8348 compatibility
- 6 RFC 1006 preferred format
- 7 Abstract decimal format for domain specific part (DSP)
- 8 Abstract binary for DSP
- 9 Printable character format for DSP (for local use only)

- 10 Dotted decimal notation (e.g. 10.0.0.6) or domain name (e.g. twg.com)
- 11 TCP port number (the default is 102)
- 12 Internet transport protocol identifier (1 = TCP and 2 = UDP)

Keywords can be specified in either upper case or lower case. However, selector values are case sensitive. Spaces are significant.

**A.3.64.1.1 Examples** The following examples illustrate the use of this data type. Note that some types of presentation address are applicable only to specific operating systems:

1. "DSA"/"DSA"/"DSA"/NS+490001aa000400d90621,CLNS

This is a typical presentation address for a Compaq DSA.

2. "my\_psel"/"my\_ssel"/"my\_tsel"/LOCAL++x0001aa000400d90621  
"my\_psel"/"my\_ssel"/"my\_tsel"/NS+490001aa000400d90621,CLNS

These examples both specify the same presentation address. The first example uses the LOCAL authority and format identifier (AFI), which does not have an initial domain identifier (IDI). The two plus signs (++) indicate that the IDI is missing. By default, the network type is CLNS. The second example uses the value of the LOCAL AFI, which is 49.

3. "256"/NS+a433bb93c1,CLNS|NS+aa3106,CONS

This is a presentation address which has a transport selector, (no presentation or session selector), and two network addresses. The first network address is CLNS (for a connectionless network) and the second is CONS (for a connection-oriented network). These network addresses are specified in concrete binary form. This form can be used only when the concrete binary representation of the network address is known.

4. #63/#41/#12/X121+234219200300,CONS

This presentation address has presentation, session and transport selectors, and a single network address which consists of an AFI (X121) and an IDI (234219200300). There is no domain specific part.

5. '3a'H/TELEX+00728722+X.25(80)+02+00002340555+CUDF+"892796"

This is an network address for X.25. Note that, because CONS is not specified, the network type defaults to CLNS.

6. RFC1006+10.0.0.6519,RFC1006

This is an RFC1006 address. The address is not an ISO network address but the combination of an IP address and a TCP port number, which is 519 in this example. The IP address can be specified as either a DNS domain name or an IP address. For an RFC1006 address, the network type can be omitted.

### A.3.65 protocolInformation

Compaq DSAs use this attribute in `decDSA` entries to specify which protocols they support for a given network address. The attribute might also be used by other OSI applications.

Compaq DSAs manage this attribute automatically, so there should never be a requirement for you to manage it manually in `decDSA` entries. The external representation of protocol information is not user-friendly.

#### Attribute Syntax

The syntax for this attribute type is `protocolInformationSyntax`.

## Default Schema Definitions

### A.3 Attributes

#### Labels

protocolInformation

For example:

```
protocolInformation='30 16 04 aa 00 04 06 06 2b 10 02 03 01 01'v
```

#### A.3.66 registeredAddress

Specifies an address associated with an object at a particular city location. The address is registered in the country in which the city is situated, and is used in the provision of the Public Telegram Service, according to CCITT Recommendation F.1.

#### Attribute Syntax

The syntax for this attribute type is `postalAddressSyntax`.

Each line of the registered address is either a printable string or a T.61 string, up to 30 characters long. Each line of the address ends with a comma. If a particular line of the address includes a comma character, quote that line. Refer to `postalAddressSyntax` for further details.

#### Labels

regaddr

registeredaddress

regaddress

For example:

```
regaddr=(3 Park Road, Littleton, Downshire, LT5 6SP)
```

#### A.3.67 rfc822Mailbox

This attribute represents the RFC822 mailbox name of a user.

#### Attribute Syntax

The syntax for this attribute type is `IA5StringSyntax`.

#### Labels

RFC822Mailbox

For example:

```
RFC822Mailbox="jones@abacus.com"
```

#### A.3.68 roleOccupant

Specifies the distinguished name of an entry that represents the occupant of an organizational role. For example, an `organizationalRole` entry representing a Sales Manager could have a `roleOccupant` attribute which specifies the name of the current sales manager.

#### Attribute Syntax

The syntax for this attribute type is `distinguishedNameSyntax`. The distinguished name should be the name of a directory entry.

#### Labels

role

roleoccupant

For example:

```
roleOccupant=/c=AU/o=Schmessel/cn="Wolf Bayer"
```

### A.3.69 searchGuide

Specifies information of suggested search criteria that could be included in an entry expected to be a convenient base-object for the search operation, for example, an organization entry.

Note that Compaq Enterprise Directory for eBusiness applications do not use search guide attributes for any operations. The attribute is supported in case other vendor's applications want to use it.

#### Attribute Syntax

The syntax for this attribute type is `searchGuideSyntax`.

#### Labels

`searchguide`

### A.3.70 seeAlso

Specifies the names of other directory entries that are in some way related to the entry of which this is an attribute. For example, an entry representing a team could include a `seeAlso` attribute that specifies the names of related teams or team leaders.

#### Attribute Syntax

The syntax for this attribute type is `distinguishedNameSyntax`. The distinguished names should be the names of directory entries.

#### Labels

`seealso`

For example:

```
seealso=/c=GH/o=Health/cn="Greta Green"
```

### A.3.71 serialNumber

Specifies a serial number. For example, an entry representing a device such as a modem could have a serial number.

A serial number can be up to 64 characters long.

#### Attribute Syntax

The syntax for this attribute type is `printableStringSyntax`, for example, `serialNumber=BN315-803`.

#### Labels

`serialno`

`serialnumber`

For example:

```
serialno=1342
```

### A.3.72 shadowingBeginTime

This is an operational attribute. Compaq DSAs use this attribute in shadowing agreement subentries.

The attribute specifies when replication is expected to start. Compaq DSAs set two values for this attribute, to cause replication every twelve hours.

There is no need to manage this attribute manually, although manual management is possible. See Section 8.10.1 for further details.

## Default Schema Definitions

### A.3 Attributes

#### Attribute Syntax

The syntax for this attribute type is `deltaTimeSyntax`.

#### A.3.73 shadowingEndTime

This is an operational attribute. Compaq DSAs use this attribute in shadowing agreement subentries.

There is no need to manage this attribute manually, although manual management is possible. See Section 8.10.1 for further details.

#### A.3.74 shadowingID

This is an operational attribute. Compaq DSAs manage this attribute automatically. Do not modify this attribute in any way.

The attribute specifies a unique identifier for the agreement. The same number appears in the agreement's relative distinguished name.

#### A.3.75 shadowingLastUpdate

This is an operational attribute. Compaq DSAs manage this attribute automatically. Do not modify this attribute in any way.

The attribute specifies the time of the last successful replication attempt.

#### A.3.76 shadowingNextUpdate

This is an operational attribute. Compaq DSAs manage this attribute automatically. Do not modify this attribute in any way.

The attribute indicates the time of the next scheduled replication attempt. This is one of the two shadowing begin times.

#### A.3.77 shadowingState

This is an operational attribute. Compaq DSAs manage this attribute automatically. Do not modify this attribute in any way.

The attribute indicates the current state of the shadowing agreement. This is usually *Active*.

#### A.3.78 shadowingMaster

This is an operational attribute. Compaq DSAs manage this attribute automatically. Do not modify this attribute in any way.

The attribute specifies the name of the master DSA for the naming context to which the shadowing agreement applies.

#### A.3.79 shadowingPeer

This is an operational attribute. Compaq DSAs manage this attribute automatically. Do not modify this attribute in any way.

The attribute specifies the name and network address of the other DSA to which this agreement applies.

#### A.3.80 shadowingKnowledgeType

This is an operational attribute. Compaq DSAs manage this attribute automatically. Do not modify this attribute in any way.

The attribute specifies what types of knowledge information, such as subordinate references, are to be included in the copy of the naming context.



### A.3.81 shadowingUPDFile

This is an operational attribute. Compaq DSAs manage this attribute automatically. Do not modify this attribute in any way.

The attribute enables the DSA to identify the update log file that contain the changes to the naming context to which this agreement applies.

### A.3.82 shadowingUPDOffset

This is an operational attribute. Compaq DSAs manage this attribute automatically. Do not modify this attribute in any way.

The attribute enables the DSA to find the information it needs to replicate. It specifies a position in an update log file.

### A.3.83 shadowingVersion

This is an operational attribute. Compaq DSAs manage this attribute automatically. Do not modify this attribute in any way.

The attribute specifies the version of the agreement. This changes every time the agreement is amended.

### A.3.84 shadowingFlags

This attribute contains flags that indicate how a Compaq DSA should process a shadowing agreement. For example, the attribute defines whether the agreement should be processed according to a schedule, or processed whenever information changes in the relevant naming context.

This is a single-valued attribute.

#### Attribute Syntax

The syntax for this attribute type is `bitStringSyntax`. However, the DXIM command line interface has a user friendly representation of the bit string. For example, for a default agreement held by a supplier DSA, the `shadowingFlags` are displayed as follows:

*UseDOP+IsSupplier+ConsumerInitiated+OtherTimes*

Each of the keywords, such as *UseDOP*, represents one bit setting. The list of keywords, punctuated by the + character, form a single attribute value. For details of the extent to which you can manage this attribute manually, see Section 8.10.1. Do not modify these flags without reading that advice.

#### Labels

`shadowingFlags`

### A.3.85 specificKnowledge

This is an operational attribute. Compaq DSAs use this attribute to represent knowledge information.

You can use the DXIM command line interface to display this attribute if you request the attribute specifically. DXIM does not display operational attributes if you use the All Attributes control.

You cannot display this attribute using the DXIM windows interface.

## Default Schema Definitions

### A.3 Attributes

#### A.3.86 stateOrProvinceName

Specifies the name of a state or province. For example, an entry representing a person can have a `stateOrProvinceName` attribute indicating what state they live or work in. A state or province name can be up to 128 characters long.

##### Attribute Syntax

The syntax for this attribute type is `stringSyntax`, for example, `stateOrProvinceName=Ohio`. This attribute specifies that it supports matching rules that are not case sensitive. For example, `stateOrProvinceName=Ohio` matches `stateOrProvinceName=OHIO`.

##### Labels

`state`  
`province`  
`stateorprovincename`

For example:

`state=Alaska`

#### A.3.87 streetAddress

Specifies a site for the local distribution and physical delivery in a postal address, road name and house number.

A street address can be up to 128 characters long.

##### Attribute Syntax

The syntax for this attribute type is `stringSyntax`, for example, `"32, The Street"`. This attribute specifies that it supports matching rules that are not case sensitive. For example, `"32, The Street"` matches `"32, the street"`

##### Labels

`addr`  
`streetaddress`  
`address`

For example:

`addr="4 Nuthatch, Banley"`

#### A.3.88 subordinateDeletedTimeStamp

This is an operational attribute. The DSA uses this attribute to record the time of the most recent deletion of a subordinate of a given entry.

Do not modify this attribute manually.

You can use the DXIM command line interface to display this attribute if you request the attribute specifically. DXIM does not display operational attributes if you use the All Attributes control.

You cannot display this attribute using the DXIM windows interface.

#### A.3.89 subtreeSpecification

This is an operational attribute. The Compaq DSA does not currently support subtree specifications, so there is no reason to modify any instance of this attribute. This attribute is used in shadowing agreement subentries, but always has a value that specifies complete subtrees.

### A.3.90 superiorKnowledge

This is an operational attribute. The DSA uses this attribute to store information about its superior reference.

Do not modify this attribute manually. You should never see this attribute, because the DSA stores it in a part of the DIT that cannot be accessed by users.

### A.3.91 supplierKnowledge

This is an operational attribute. Compaq DSAs use this attribute to store information about the replication of information.

A Compaq DSA adds this attribute to naming contexts that it holds, but for which it is a shadow DSA rather than the master DSA.

You can use the DXIM command line interface to display this attribute if you request the attribute specifically. However, the attribute is not displayed in a user-friendly format. DXIM does not display operational attributes if you use the All Attributes control.

You cannot display this attribute using the DXIM windows interface.

See also the `consumerKnowledge` attribute.

See Chapter 5 for details of consumer DSAs and supplier DSAs.

### A.3.92 supportedApplicationContext

Specifies the object identifier of an application context. For example, an application entity could have a `supportedApplicationContext` attribute that specifies the contexts that the application entity supports.

#### Attribute Syntax

The syntax for this attribute type is `objectIdentifierSyntax`, for example, {2 13 3 19}.

#### Labels

`context`  
`supportedapplicationcontext`

For example:

```
context={2 5 3 2}
```

### A.3.93 surname

Specifies the surname, or family name, of a person.

A surname can be up to 64 characters long.

#### Attribute Syntax

The syntax for this attribute type is `stringSyntax`, for example, `surname=Stevenson` or `surname=Müller`. This attribute specifies that it supports matching rules that are not case sensitive. For example, `surname=Stevenson` matches `surname=STEVENSON`.

#### Labels

`surname`  
`sn`  
`lastname`

For example:

## Default Schema Definitions

### A.3 Attributes

surname=Bloggs

#### A.3.94 trustedDSAName

This is an operational attribute. Compaq DSAs use this attribute as part of security. The presence of the attribute indicates that the DSA is part of a security domain.

The syntax of this attribute is `distinguishedNameSyntax`.

This operational attribute does require some manual management, for which you must use the DXIM command line interface.

You cannot display or manage this attribute using the DXIM windows interface.

See Section 4.5 for information about managing this attribute.

##### Attribute Syntax

The syntax for this attribute type is `distinguishedNameSyntax`.

##### Labels

`trustedDSAName`

For example:

```
trustedDSAName=/c=us/o=abacus/cn=DSA1
```

#### A.3.95 telephoneNumber

Specifies a telephone number.

##### Attribute Syntax

The syntax for this attribute type is `telephoneNumberSyntax`, for example, `telephoneNumber="+44 582 10101"`.

The string should comply with the internationally agreed format for showing international telephone numbers.

##### Labels

`tel`

`telephonenumber`

For example:

```
tel="+44 583 10101"
```

#### A.3.96 teletexTerminalIdentifier

Specifies the teletex terminal identifier for a teletex terminal. Optionally, this attribute type can also specify the teletex terminal parameters.

##### Attribute Syntax

The syntax for this attribute type is `teletexTerminalIdentifierSyntax`.

An attribute value for `TeletexTerminalIdentifier` is a string that complies with CCITT Recommendation F.200, and an optional set that complies with CCITT Recommendation T.62.

**Labels**

TTXid  
teletexTerminalIdentifier  
ttxTerminalIdentifier

For example:

TTXid="12345"

**A.3.97 telexNumber**

Specifies the telex number, country code, and answerback code of a telex terminal.

**Attribute Syntax**

The syntax for this attribute type is a sequence of three strings of characters from the printable string character set. The strings correspond to the following:

Telex number  
Answerback  
Country code

For example, "12434 ABACUS US".

Note that Compaq DSAs do not verify that the strings are specified in the correct order.

**Labels**

telexno  
telexnumber  
telex

For example:

telexno="12434 ABACUS US"

**A.3.98 title**

Specifies a position, function, or occupational qualification of an object. For example, a person could have a title of "manager" or "chief designer", and a device could have a title such as "disk drive".

A title can be up to 64 characters long.

**Attribute Syntax**

The syntax for this attribute type is `stringSyntax`, for example, `title="Sales Manager"`. This attribute specifies that it supports matching rules that are not case sensitive. For example, `title="Sales Manager"` matches `title="SALES MANAGER"`.

**Labels**

title

For example:

title=Boss

## Default Schema Definitions

### A.3 Attributes

#### A.3.99 userPassword

Specifies a password.

Directory applications use the `userPassword` attribute to authenticate users to DSAs, and DSAs use passwords to verify each other's identities.

A user password can be up to 128 characters long, and is case sensitive.

##### Attribute Syntax

The syntax for this attribute type is `userPasswordSyntax`. User passwords are stored as octet strings. A password can be up to 128 characters long.

Usually, passwords are protected by access controls, so that values are not displayed. However, if there are no such controls, passwords can be displayed as text or as an octet string, depending on the application that is displaying them.

##### Labels

`password`  
`userpassword`  
`pwd`  
`userpwd`

For example:

```
password=tribblet
```

#### A.3.100 x121Address

Specifies a network address of the named object.

An X.121 address can be up to 15 characters long.

##### Attribute Syntax

The syntax for this attribute type is a string of numeric characters that complies with CCITT Recommendation X.121.

##### Labels

`x121address`

For example:

```
x121address="234273412345"
```

## A.4 Syntaxes

This section describes the attribute value syntaxes that define the permitted format of values for the selected attribute types.

### A.4.1 aciSyntax

The `aciSyntax` is an example of a complex syntax. It is used as the value syntax for prescriptiveACI attributes to specify the access controls to be applied to directory information.

Appendix B describes the syntax in detail, and documents what keywords to use in DXIM command lines. Other vendors' utilities are likely to support a different set of keywords. Chapter 7 describes how to plan access controls for your organization's directory information tree. The DXIM windows interface does not support the management of attributes that have this complex syntax.

The equality matching rule supported for this syntax is:

```
aciItemMatch
```

No other types of matching are supported for this syntax.

#### A.4.2 bitStringSyntax

This syntax allows you to store attribute values as bit strings.

There is no matching rule defined for this syntax. If you attempt to match a bit string value, the DSA only checks whether the encoding is the same. An example of a bit string value is '010101'b.

#### A.4.3 booleanSyntax

This allows the attribute value to have the syntax of a boolean value, for example, 0 to represent false and 1 to represent true.

The equality matching rule for this syntax is:

`booleanMatch`

No other types of matching are supported.

#### A.4.4 countryNameSyntax

Values of this syntax must be alphabetic country codes defined in ISO 3166. Each country code is two letters long. For example, GB and US. ISO 3166 is sometimes revised to reflect political changes. The syntax reflects the revision of the standard published in February 1994.

The list of codes supported by the Compaq DSA is as follows:

AD AE AF AG AI AL AM AN AO AQ AR AS AT AU AW AZ BA BB BD BE  
BF BG BH BI BJ BM BN BO BR BS BT BV BW BY BZ CA CC CF CG CH  
CI CK CL CM CN CO CR CU CV CX CY CZ DE DJ DK DM DO DZ EC EE  
EG EH ER ES ET FI FJ FK FM FO FR FX GA GB GD GE GF GH GI GL  
GM GN GP GQ GR GS GT GU GW GY HK HM HN HR HT HU ID IE IL IN  
IO IQ IR IS IT JM JO JP KE KG KH KI KM KN KP KR KW KY KZ LA  
LB LC LI LK LR LS LT LU LV LY MA MC MD MG MH MK ML MM MN MO  
MP MQ MR MS MT MU MV MW MX MY MZ NA NC NE NF NG NI NL NO NP  
NR NU NZ OM PA PE PF PG PH PK PL PM PN PR PT PW PY QA RE RO  
RU RW SA SB SC SD SE SG SH SI SJ SK SL SM SN SO SR ST SV SY  
SZ TC TD TF TG TH TJ TK TM TN TO TP TR TT TV TW TZ UA UG UM  
US UY UZ VA VC VE VG VI VN VU WF WS YE YT YU ZA ZM ZR ZW

Refer to ISO 3166 for details of what each code stands for.

The equality matching rule supported for this syntax is:

`caseIgnoreStringMatch`

The ordering matching rule supported for this syntax is:

`caseIgnoreStringMatch`

The substring matching rule supported for this syntax is:

`caseIgnoreSubstringMatch`

This means that the value GB matches gb, and that you can request a substring match. For example, you can search for `countryName=u*` to find all country codes beginning with the letter u.

## Default Schema Definitions

### A.4 Syntaxes

#### A.4.5 `deltaTimeSyntax`

This syntax represents a time of day, and can indicate a specific day of the week. For example:

```
0 123500
```

This represents 12:35.00 every day. The leading zero can be replaced by an integer in the range 1 to 7, where 1 is Monday, to represent a specific day of the week.

This syntax is used by the DSA in the `shadowingBeginTime` and `shadowingEndTime` attributes to represent a replication schedule in a shadowing agreement subentry. See Section 8.10.1 for further details.

The equality matching rule supported for this syntax is:  
`deltaTimeMatch`

#### A.4.6 `directoryStringSyntax`

The X.500 schema does not use the name `directoryStringSyntax` for this syntax. The X.500 schema uses the CCITT 1988 name `stringSyntax`. See Section A.4.23.

#### A.4.7 `distinguishedNameSyntax`

This allows the attribute value to have the syntax of a distinguished name. For example:

```
/countryName=US/organizationName=ACME/organizationalUnitName=Sales
```

See Chapter 1 or the DXIM online help for a description of the format of a distinguished name.

The equality matching rule supported for this syntax is:  
`distinguishedNameMatch`

The ordering matching rule supported for this syntax is:  
`distinguishedNameMatch`

#### A.4.8 `facsimileTelephoneNumberSyntax`

This syntax allows the representation of facsimile telephone numbers, formatted according to the international agreement. Currently, Compaq DSAs do not support the optional `G3FacsimileTextNonBasicParameters`.

The only matching rule supported for this syntax is `exactEncodingMatch`. This means that the DSA can only check whether the encoding of the value matches. Substring, ordering, and approximate matches are not possible.

#### A.4.9 `generalizedTimeSyntax`

This syntax allows the representation of a time, as follows:

```
19931201140545.123Z
```

The above example represents 1993, December 1st, at 45 seconds past 2.05 p.m. The value also specifies fractions of a second, to three decimal places.

Compaq's DSA currently requires you to specify fractions of a second, even if you only specify 000. If you define an attribute that uses this syntax, you need to make sure that your users are aware of this requirement.

The default schema contains only two attributes that use this syntax, and they are both operational attributes used only by the DSA.



The equality matching rule supported for this syntax is:  
`generalizedTimeEqualityMatch`

The ordering matching rule supported for this syntax is:  
`generalizedTimeOrderingMatch`

#### A.4.10 `ia5StringSyntax`

This syntax allows the representation of strings using international alphabet 5 characters. This character set includes characters that are not in the printable string character set, such as the @ character.

The equality matching rules for this syntax are:

`caseIgnoreIA5StringMatch`  
`caseExactIA5StringMatch`

The ordering matching rules for this syntax are:

`caseIgnoreIA5StringMatch`  
`caseExactIA5StringMatch`

The substring matching rules for this syntax are:

`caseIgnoreIA5SubstringMatch`  
`caseExactIA5SubstringMatch`

There is no approximate matching rule for this syntax.

The `ia5StringSyntax` is provided to support some attributes defined in COSINE.SC.

#### A.4.11 `integerListSyntax`

This syntax allows the representation of integer lists. For example, "1, 2, 3, 4, 5".

This syntax is not supported by any matching rule. This means that the only matching function that the DSA can provide is an equality match of the octets used to encode a value for storage. Other matching functions are not supported.

#### A.4.12 `integerSyntax`

This allows the attribute value to have the syntax of an integer value, for example, 283.

The equality matching rule for this syntax is:

`integerMatch`

The ordering matching rule for this syntax is:

`integerMatch`

#### A.4.13 `mhs-or-address-syntax`

This allows an attribute value to have the syntax of an X.400 originator/recipient address, for example:

"C=US; A=Admin; P=Abacus; O=Abacus; G=David; S=Townsend; OU1=Legal"

The equality matching rule for this syntax is `mhs-or-address-match`. There are no other matching rules for this syntax.

## Default Schema Definitions

### A.4 Syntaxes

#### A.4.14 mhs-or-name-syntax

This allows an attribute to have the value of a X.400 OR name. This may be either an X.400 OR address (see `mhs-or-address-syntax`) or an X.500 directory name (see `distinguishedNameSyntax`).

The equality matching rule supported for this syntax is:

`dec-mts-or-name-match`

#### A.4.15 numericStringSyntax

This allows the attribute value to have the syntax of a string of numeric characters, for example, "85 14 7 40 243".

The equality matching rule supported for this syntax is:

`numericStringMatch`

The ordering matching rule supported for this syntax is:

`numericStringMatch`

The substring matching rule supported for this syntax is:

`numericSubstringMatch`

#### A.4.16 objectIdentifierSyntax

This allows the attribute value to have the syntax of an object identifier. An object identifier is an ordered sequence of integers in braces. For example, {2 5 6 2} is the object identifier for the `country` object class.

The equality matching rule supported for this syntax is:

`objectIdentifierMatch`

The ordering matching rule supported for this syntax is:

`objectIdentifierMatch`

#### A.4.17 octetStringSyntax

This allows the attribute value to have the syntax of a string of octets. An example of a value of this syntax is 'A1B2C3'H.

The equality matching rule supported for this syntax is:

`octetStringMatch`

The ordering matching rule supported for this syntax is:

`octetStringMatch`

#### A.4.18 postalAddressSyntax

This syntax allows the representation of a postal address of up to six lines. Each line of the address can contain up to 30 characters of the printable string or T.61 string character sets. The DXIM external representation of the address uses the comma character to separate lines. For example;

"The Wicket, 14 Ace Avenue, Lower Dingle, nr Tatton, Hampshire, England"

The equality matching rule supported for this syntax is:

`caseIgnoreListMatch`

The ordering matching rule supported for this syntax is:

`caseIgnoreListMatch`

The substring matching rule supported for this syntax is:

`caseIgnoreListSubstringMatch`

#### A.4.19 presentationAddressSyntax

This syntax allows the representation of a presentation address. See Section 5.2.3 for details of the format of presentation addresses used by Compaq's Directory Service.

The equality matching rule supported for this syntax is:

`presentationAddressMatch`

No other types of matching are supported.

#### A.4.20 printableStringSyntax

This allows the attribute value to have the syntax of a string of characters from the printable string character set.

The equality matching rules supported for this syntax are:

`caseIgnoreStringMatch`

`caseExactStringMatch`

The ordering matching rules supported for this syntax are:

`caseIgnoreStringMatch`

`caseExactStringMatch`

The substring matching rules supported for this syntax are:

`caseIgnoreSubstringMatch`

`caseExactSubstringMatch`

The approximate matching rules supported for this syntax are:

`allWordApproximateMatch`

`initialLetterApproximateMatch`

`initialWordApproximateMatch`

`lastWordSoundexMatch`

#### A.4.21 protocolInformationSyntax

This syntax allows the representation of protocol information to be used by OSI applications.

The external representation of this syntax is not user-friendly. The only matching rule supported for this syntax is `exactEncodingMatch`. Substring, ordering, and approximate matching is not possible.

#### A.4.22 stringListSyntax

This syntax allows you to represent a list of up to six strings. The DXIM external representation of a string list uses the comma character to separate the list items. For example, "One, Two, Three, Four, Five, Six".

The equality matching rule supported for this syntax is:

`caseIgnoreListMatch`

The ordering matching rule supported for this syntax is:

`caseIgnoreListMatch`

The substring matching rule supported for this syntax is:

`caseIgnoreListSubstringMatch`

## Default Schema Definitions

### A.4 Syntaxes

#### A.4.23 stringSyntax

This syntax allows you to represent a string using the printable character set or the T.61 character set. The T.61 character set includes characters such as é and ç.

The equality matching rules supported for this syntax are:

`caseIgnoreStringMatch`  
`caseExactStringMatch`

The ordering matching rules supported for this syntax are:

`caseIgnoreStringMatch`  
`caseExactStringMatch`

The substring matching rules supported for this syntax are:

`caseIgnoreSubstringMatch`  
`caseExactSubstringMatch`

The approximate matching rules supported for this syntax are:

`allWordApproximateMatch`  
`initialLetterApproximateMatch`  
`initialWordApproximateMatch`  
`lastWordSoundexMatch`

#### A.4.24 telephoneNumberSyntax

This allows the attribute value to have the syntax of a string of numeric characters from the printable string character set.

The equality matching rule for this syntax is:

`telephoneNumberMatch`

The ordering matching rule for this syntax is:

`telephoneNumberMatch`

The substring matching rule for this syntax is:

`telephoneNumberSubstringMatch`

#### A.4.25 teletexTerminalIdentifierSyntax

This syntax allows the representation of a teletex terminal identifier. The syntax is a string that complies with ITU-T Recommendation F.200, followed by an optional set of characters that complies with ITU-T Recommendation T.62.

The equality matching rule for this syntax is:

`exactEncodingMatch`

#### A.4.26 telexNumberSyntax

This syntax allows the representation of a telex number. A telex number comprises three printable strings: the telex number, a country code, and an answerback code. For example, "1234 ABACUS US".

The equality matching rule for this syntax is:

`caseIgnoreListMatch`

The ordering matching rule for this syntax is:

`caseIgnoreListMatch`

The substring matching rule for this syntax is:

`caseIgnoreListSubstringMatch`

#### A.4.27 `undefinedSyntax`

This syntax allows the representation of values that do not conform to any syntax known to the DSA, as long as they are encoded in valid ASN.1. This syntax might be suitable for applications that have specific syntax requirements which are not met by any of the other default syntaxes. In that case, you can use this syntax. However, the simplified matching provided by the DSA means that the application must take responsibility for ensuring that values meet their syntactic requirements. The application must also be consistent in its production of ASN.1 encoding, otherwise values are unlikely to match octet for octet.

An example of the external representation of a value of this syntax is `'130142'v`. The letter `v` signifies that the value is shown verbatim.

#### A.4.28 `userPasswordSyntax`

This syntax allows the representation of user passwords.

The equality matching rule for this syntax is:

`octetStringMatch`

No other types of matching are supported for this syntax.

#### A.4.29 `uTCTimeSyntax`

This allows the attribute value to have the syntax of a numeric value representing a time. An example of a value of this syntax is:

`910311213922Z`

That value represents 1991, March 3rd, at 22 seconds past 9.39 p.m.

The syntax has a two digit year. It assumes that years less than 50 are after 2000 and years greater or equal to 50 are after 1950 and less than 2000.

The equality matching rule for this syntax is:

`uTCTimeMatch`

The ordering matching rule for this syntax is:

`uTCTimeMatch`

### A.5 Matching Rules

This section documents the matching rules supported by Compaq DSAs.

When you are defining new attribute types for your Directory Service, you must select a syntax for that attribute type. The DSA supports one or more matching rules for each syntax. When you define a new attribute, you must select one or more matching rules that are applicable to the chosen syntax for one or more types of matching.

For example, if you define an attribute that has `stringSyntax`, you must choose matching rules from the following list of applicable rules, categorized by the type of matching they are suitable for:

Equality Matching

`caseIgnoreStringMatch`

`caseExactStringMatch`

Ordering Matching

`caseIgnoreStringMatch`

`caseExactStringMatch`

## Default Schema Definitions

### A.5 Matching Rules

Substring Matching  
`caseIgnoreSubstringMatch`  
`caseExactSubstringMatch`

Approximate Matching  
`allWordApproximateMatch`  
`lastWordSoundexMatch`  
`initialLetterApproximateMatch`  
`initialWordApproximateMatch`

For example, the default schema contains the definition of the `commonName` attribute, as follows:

```
commonName ATTRIBUTE
  WITH ATTRIBUTE-SYNTAX stringSyntax (SIZE(1..64))
  EQUALITY MATCHING RULE caseIgnoreStringMatch
  ORDERING MATCHING RULE caseIgnoreStringMatch
  SUBSTRING MATCHING RULE caseIgnoreSubstringMatch
  APPROXIMATE MATCHING RULE initialWordApproximateMatch
  STORE NORMALIZED
  ::= {attributeType 3}
```

Note that some matching rules are suitable for more than one type of matching. The `caseIgnoreStringMatch` is specified for both equality matching and ordering matching.

Each matching rule is listed under each of the types of matching for which it can be used. For example, `caseIgnoreStringMatch` is listed as an equality matching rule and as an ordering matching rule.

#### A.5.1 Equality Matching Rules

##### A.5.1.1 `aciItemMatch`

This matching rule can apply to:  
`aciSyntax`.

For two values to be considered to match, they must have the same identification string. Case-insensitive matching is applied to the identification strings to determine whether they match. Other elements of the values cannot be matched.

Note that this means that values that look different to a user may be considered identical by the DSA. For example, any two ACIitems that have the identification string "Directory Manager's Access Controls" are considered to match regardless of what controls are specified within them.

Note that the DXIM command line interface does not support searches for specific identification strings. For example, you cannot use the following DXIM command:

```
dxim> search /c=us/o=abacus -
_dxim> where prescriptiveaci="Directory Manager's" -
_dxim> attribute prescriptiveaci
```

DXIM does allow you to find all prescriptiveACI attributes, regardless of identification string, as follows:

```
dxim> search /c=us/o=abacus where prescriptiveaci=* -
_dxim> attribute prescriptiveaci
```

You can use the COMPARE command to check for the presence of a particular identification string, and you can specify an identification string in SHOW and DELETE commands. Thus, if an attribute contains more than one value, you can specify which value you want to show or delete by reference to its identification string.

See Appendix B for a full description of the identification string and all other elements of the syntax of an ACItem.

#### A.5.1.2 booleanMatch

This matching rule can apply to:  
booleanSyntax.

For two values to match they must be either both TRUE, or both FALSE.

#### A.5.1.3 caseExactIA5StringMatch

This matching rule applies to:  
ia5StringSyntax

For two values to match, corresponding characters must be identical, including being of the same case, for example, "T" does not equal "t".

Consecutive space characters in either value are treated as a single space character. If the values are of different lengths, ignoring any difference caused by consecutive space characters, then the values do not match.

#### A.5.1.4 caseExactStringMatch

This matching rule can apply to:  
stringSyntax  
printableStringSyntax  
countryNameSyntax.

For two values to match, corresponding characters must be identical, including being of the same case, for example "T" does not equal "t".

Consecutive space characters in either value are treated as a single space character. If the values are of different lengths, ignoring any difference caused by consecutive space characters, then the values do not match.

#### A.5.1.5 caseIgnoreListMatch

This matching rule can apply to:  
stringListSyntax  
postalAddressSyntax.

For two values to match, they must contain the same number of strings, and corresponding strings must match according to the caseIgnoreStringMatch.

#### A.5.1.6 caseIgnoreIA5StringMatch

This matching rule applies to:  
ia5StringSyntax

For two values to match, corresponding characters must be identical, except that case may vary.

Consecutive space characters in either value are treated as a single space character. If the values are of different lengths, ignoring any difference caused by consecutive space characters, then the values do not match.

## Default Schema Definitions

### A.5 Matching Rules

#### A.5.1.7 caseIgnoreStringMatch

This matching rule can apply to:

`stringSyntax`  
`printableStringSyntax`  
`countryNameSyntax`.

For two values to match, corresponding characters must be identical, except that case may vary.

Consecutive space characters in either value are treated as a single space character. If the values are of different lengths, ignoring any difference caused by consecutive space characters, then the values do not match.

#### A.5.1.8 dec-mts-or-name-match

This matching rule can apply to:

`mhs-or-name-syntax`

If an OR name is in the format of an X.500 directory name, the matching rules for `distinguishedNameMatch` apply. If an OR name is in the format of an X.400 OR address, the matching rules for `mhs-or-address-match` apply.

#### A.5.1.9 deltaTimeMatch

This matching rule can apply to:

`deltaTimeSyntax`

For two values to match, they must represent the same time and the same day of the week. If the seconds are not specified in either value being matched, the seconds are assumed to be 00.

#### A.5.1.10 distinguishedNameMatch

This matching rule can apply to:

`distinguishedNameSyntax`

For two values to be considered to match, the following must all be true:

- The number of Relative Distinguished Names (RDNs) in the two Distinguished Names (DN) must be the same.
- Corresponding RDNs must have the same number of attribute values.
- Corresponding RDNs must be composed of the same attribute types.
- Corresponding attribute values must match for equality according to the relevant matching rule.

For example, the distinguished name `/countryName=US` matches the distinguished name `/c=us` because both names have one RDN, both RDNs have one attribute value, the attributes are both `countryName`, and the values match according to the case insensitive matching rule that applies to the `countryNameSyntax`

#### A.5.1.11 exactEncodingMatch

This matching rule can apply to the following syntaxes:

`undefinedSyntax`  
`facsimileTelephoneNumberSyntax`  
`protocolInformationSyntax`  
`integerListSyntax`  
`bitStringSyntax`  
`teletexTerminalIdentifierSyntax`



For two values to match, their ASN.1 encoding must be identical, octet for octet. The `exactEncodingMatch` matching rule provides a minimal ability to match for syntaxes for which a specialised matching rule has not been implemented.

**A.5.1.12 `generalizedTimeEqualityMatch`**

This matching rule can apply to:  
`generalizedTimeSyntax`

For two values to match, they must represent exactly the same time, including the fractions of a second.

**A.5.1.13 `integerMatch`**

This matching rule can apply to:  
`integerSyntax`

For two values to match, they must represent the same integer.

**A.5.1.14 `mhs-or-address-match`**

This matching rule can apply to:  
`mhs-or-address-syntax`

For two values to match, the corresponding terms must be identical except for case. The terms can be specified in any order. For example, the following values match:

```
"C=US; A=Admin; P=Abacus; O=Abacus; G=David; S=Townsend; OU1=Legal"
```

```
"C=US; A=Admin; P=Abacus; O=Abacus; OU1=Legal; G=David; S=Townsend"
```

If you are using this attribute to support an X.400 messaging application, refer to that application's documentation for details of the ORaddress formats it supports.

**A.5.1.15 `numericStringMatch`**

This matching rule can apply to:  
`numericStringSyntax`

For two values to match, the corresponding numeric characters in the strings must match exactly.

Space characters in either value are ignored. For example, "1 2 3" matches "123".

**A.5.1.16 `objectIdentifierMatch`**

This matching rule can apply to:  
`objectIdentifierSyntax`

For two values to match, corresponding elements must match exactly. Consecutive space characters are treated as a single space.

**A.5.1.17 `octetStringMatch`**

This matching rule can apply to:  
`octetStringSyntax`  
`userPasswordSyntax`

For two values to match, the strings must be of the same length, and corresponding octets must be identical.

## Default Schema Definitions

### A.5 Matching Rules

#### A.5.1.18 presentationAddressMatch

This matching rule can apply to:  
`presentationAddressSyntax`

For two presentation addresses to match, each selector must be identical, and the network addresses specified must be a subset of the network addresses stored in the Directory. For example, the following presentation addresses match if the second address is the one stored in the Directory.

```
"DSA"/"DSA"/"DSA"/NS+4900|4911  
"DSA"/"DSA"/"DSA"/NS+4900|4911|4922
```

The two network addresses specified in the first presentation address are a subset of the ones in the second presentation address.

#### A.5.1.19 telephoneNumberMatch

This matching rule can apply to:  
`telephoneNumberSyntax`

For two values to match, the corresponding characters in each value must be identical

Space characters and dash characters "-" are ignored. For example, "44 123-456" matches "44123456".

#### A.5.1.20 uTCTimeMatch

This matching rule can apply to:  
`uTCTimeSyntax`

For two values to match, the values must represent the same time. If either value omits to specify seconds, then the number of seconds is assumed to be zero.

### A.5.2 Ordering Matching Rules

#### A.5.2.1 caseExactIA5StringMatch

This matching rule applies to:  
`ia5StringSyntax`

Values are ordered by comparison of corresponding characters. Lower case characters are treated as higher than upper case characters, for example, smith is ordered higher than Smith. The letter A is the lowest letter, and the letter Z the highest.

#### A.5.2.2 caseExactStringMatch

This matching rule can apply to:  
`stringSyntax`  
`printableStringSyntax`  
`countryNameSyntax`.

Values are ordered by comparison of corresponding characters. For example, Smith is ordered lower than Trent because the first characters differ, and S is lower than T. Lower case characters are treated as higher than upper case characters. For example, smith is higher than Smith.

#### A.5.2.3 caseIgnoreIA5StringMatch

This matching rule applies to:

`ia5StringSyntax` Values are ordered by comparison of corresponding characters. Upper case and lower case representations of the same character are considered equal, for example, smith is considered equal to SMITH. The letter A is the lowest letter, and the letter Z the highest.

#### A.5.2.4 caseIgnoreListMatch

This matching rule can apply to:

stringListSyntax  
postalAddressSyntax

Values are ordered by comparison of corresponding list elements. For example, "ABC DEF" is higher than "A B C DEF" because the first elements in the two lists differ, and ABC is higher than A.

#### A.5.2.5 caseIgnoreStringMatch

This matching rule can apply to:

stringSyntax  
printableStringSyntax  
countryNameSyntax

Values are ordered by comparison of corresponding characters, without regard for the case of the characters. The character "c" is equal to "C".

#### A.5.2.6 distinguishedNameMatch

This matching rule can apply to:

distinguishedNameSyntax

Values are ordered by comparison of corresponding RDNs. If corresponding RDNs are formed using different attributes, then the attributes are ordered according to their object identifiers. For example, "/commonName=Smith" is ordered lower than "/surname=Smith" because the object identifier of the `commonName` attribute is lower.

For RDNs formed using the same attribute, the values are ordered according to the ordering matching rule that applies to the syntax of that attribute.

#### A.5.2.7 generalizedTimeOrderingMatch

This matching rule can apply to:

generalizedTimeSyntax

Values are ordered according to the times that they represent.

#### A.5.2.8 integerMatch

This matching rule can apply to:

integerSyntax

Values are ordered according to the integers they represent.

#### A.5.2.9 numericStringMatch

This matching rule can apply to:

numericStringSyntax

Values are ordered by comparison of corresponding numeric characters. For example, 9 is ordered higher than 10 because the first characters differ, and 9 is higher than 1.

#### A.5.2.10 objectIdentifierMatch

This matching rule can apply to:

objectIdentifierSyntax

Values are ordered by comparison of corresponding elements.

## Default Schema Definitions

### A.5 Matching Rules

#### A.5.2.11 `octetStringMatch`

This matching rule can apply to:  
`octetStringSyntax`

Values are ordered by comparison of corresponding octets, and corresponding bits within octets. The first occurrence of a different bit determines the ordering of the octet strings. A zero is ordered before a one.

#### A.5.2.12 `telephoneNumberMatch`

This matching rule can apply to:  
`telephoneNumberSyntax`

Values are ordered according by comparison of corresponding characters, ignoring space characters and hyphen (-) characters.

#### A.5.2.13 `uTCTimeMatch`

This matching rule can apply to:  
`uTCTimeSyntax`

Values are ordered according to the times they represent.

### A.5.3 Substring Matching Rules

Substring matching rules enable users to use wildcards when searching for entries. More than one wildcard can be specified. For example, a DXIM command line user can use the following search command:

```
dxim> search /c=us/o=abacus where surname=*sm*th*
```

The positions of the three wildcard characters means that this search might return entries with the following surname values: smith, nesmith, smithson, smythe, smallworthy.

A DXIM windows user can specify wildcards in the input fields of the Find window.

#### A.5.3.1 `caseExactIA5SubstringMatch`

This matching rule applies to:  
`ia5StringSyntax`

The matching rule determines whether a string specified by the user matches any substring of a value in the Directory. The match is case sensitive.

#### A.5.3.2 `caseExactSubstringMatch`

This matching rule can apply to:  
`stringSyntax`  
`printableStringSyntax`

The matching rule determines whether a string specified by the user matches any substring of a value in the Directory. The match is case sensitive.

#### A.5.3.3 `caseIgnoreListSubstringMatch`

This matching rule can apply to:  
`stringListSyntax`  
`postalAddressSyntax`

The matching rule determines whether a string or list or strings specified by the user matches any substring or substrings of a value stored in the Directory.

For example, a DXIM command line user can use the following command:

```
dxim> search /c=us/o=abacus where postalAddress="*Smith, *London"
```

The above request matches successfully against any `postalAddress` attribute that contains a list item ending in the substring `Smith`, immediately followed by a list item containing the substring `London`. The substring matching uses the Section A.5.1.7.

For example, the command might return an entry that has the following `postalAddress` value:

```
postalAddress="John Smith, 47 London Street, Oxford, Oxfordshire"
```

Note that the rule does not match a substring across list items. For example, the same request would not return the following `postalAddress` value:

```
postalAddress="Jim Smith, 3rd Pylon, Don Street"
```

The above value contains the substring `London`, but the substring is split across list items, and does not match.

#### A.5.3.4 `caseIgnoreIA5SubstringMatch`

This matching rule applies to `IA5StringSyntax`.

The matching rule determines whether a string specified by the user matches any substring of a value stored in the Directory. Upper case and lower case representations of the same character are considered to match, for example, a search for `*smith` might return `WORDSMITH`.

#### A.5.3.5 `caseIgnoreSubstringMatch`

This matching rule applies to `stringSyntax`, `printableStringSyntax`, and `countryNameSyntax`.

The matching rule determines whether a string specified by the user matches any substring of a value stored in the Directory.

The use of a wildcard character indicates that a substring match is required. More than one wildcard character may be specified.

For example, a DXIM command line user can use the following command:

```
dxim> search /c=us/o=abacus where surname=ad*son*
```

The above request matches successfully against any `surname` attribute that ends with the substring beginning with the letters "ad" and containing the letters "son". Matches might include `Adson`, `Adamson`, and `Addissons`.

#### A.5.3.6 `numericSubstringMatch`

This matching rule can apply to:  
`numericStringSyntax`

The matching rule determines whether a numeric string specified by the user matches any substring of a value in the Directory.

#### A.5.3.7 `telephoneNumberSubstringMatch`

This matching rule can apply to:  
`telephoneNumberSyntax`

The matching rule determines whether a string specified by the user matches any substring of a value in the Directory, ignoring any spaces or hyphen (-) characters.

## Default Schema Definitions

### A.5 Matching Rules

#### A.5.4 Approximate Matching Rules

Compaq DSAs support a number of approximate matching rules. These rules enable users to search for entries that match a specified string phonetically. The rules are based on Soundex.

For example, a DXIM command line user can use the following search command:

```
dxim> search /c=us/o=abacus where surname~=jonson
```

The above request would match entries with surnames such as Jonson, Johnson, Jonnson, and Jansen.

The DXIM windows interface does not currently support approximate matching.

The default schema define only two attributes that support approximate matching: `commonName` and `surname`.

The only syntaxes that support approximate matching are `stringSyntax` and `printableStringSyntax`. If you define an attribute that uses either of those syntaxes, then you may want to specify that the attribute uses one of the approximate matching rules.

##### A.5.4.1 allWordApproximateMatch

This matching rule can apply to:

```
stringSyntax  
printableStringSyntax
```

The matching rule applies case-insensitive approximate matching for strings that contain several words. For example, a DXIM user could use the following command, where `exampleAttribute` is an attribute that supports this matching rule:

```
dxim> search /c=us/o=abacus where exampleAttribute~="Alan Peter Moore"
```

The match takes each word in the specified string, and matches against any `exampleAttribute` attribute in the directory that has three strings that are phonetically equivalent to those strings. For example, the command might return the following matches:

```
exampleAttribute="Ellen Peta More"  
exampleAttribute="Allan Peter More"  
exampleAttribute="Allen Peter Muir"
```

The rule considers spaces to be divisions between words, and considers the order and number of the words to be significant. For example, the above search would not match "John Allen Peter Moore", or "Peter Alan Moore".

##### A.5.4.2 initialLetterApproximateMatch

This matching rule can apply to:

```
stringSyntax  
printableStringSyntax
```

This matching rule applies a case-insensitive comparison to the first letter of a value, and a phonetic comparison to the last word of a value. The matching rule considers space characters to be divisions between words. A value is considered to match if the first letter is the same, and the last word matches phonetically.

For example, a DXIM command line user could use the following command to make an approximate match using the `exampleAttribute`:

```
dxim> search /c=us/o=abacus where exampleAttribute~="Alan Michael Moore"
```

The request would match any `exampleAttribute` values that begin with the letter A, and which phonetically match Moore. Phonetic matches of Moore might include More, Moor, and Muir.

The string Michael, and the remaining letters of Alan are ignored by the matching rule. Only the first letter and the last word are compared with values in the Directory.

Note that none of the attributes defined in the default schema use this matching rule.

#### A.5.4.3 `initialWordApproximateMatch`

This matching rule can apply to:

`stringSyntax`  
`printableStringSyntax`

This rule provides phonetic matching for first and last terms of a name. Other terms are ignored. For example:

```
dxim> search /c=us/o=abacus where commonName~="Alan Moore"  
  
/C=US/O=Abacus/OU=Sales/CN=Alan Moore  
/C=US/O=Abacus/OU=Accounts/CN=Alan Francis Moore  
/C=US/O=Abacus/OU=Retail/CN=Allen Muir
```

The second listed entry matches despite the fact that it has a middle name that the user did not specify. The matching rule only checks the first and last terms of the value. The last listed entry matches phonetically.

The `commonName`, `givenName` and `surname` attributes use this approximate matching rule.

#### A.5.4.4 `lastWordSoundexMatch`

This matching rule can apply to:

`stringSyntax`  
`printableStringSyntax`

The rule applies a phonetic comparison to the last word of a value in the Directory. The rule considers space characters to be the divisions between words. For example, a DXIM command line user can use the following command:

```
dxim> search /c=us/o=abacus where exampleAttribute~="Alan Michael Moore"
```

The request would match any `exampleAttribute` values that have a last word that phonetically matches Moore. For example, any values ending in the word Moore, More, Moor, and Muir are returned. The strings Alan and Michael are ignored by the matching rule.

None of the attributes in the default schema use this matching rule.





# B

---

## The PrescriptiveACI Attribute

The `prescriptiveACI` attribute contains information that specifies restrictions on user access to directory information. This attribute has a complex syntax, which requires the use of keywords. Other vendors' utilities might use a different set of keywords to the ones supported by DXIM.

Each `PrescriptiveACI` attribute can contain several statements of access control, each of which is called an access control information item (ACIitem). Each ACIitem contains details of the controls that apply to specific directory users' access to specific directory information.

Each ACIitem can be specified in one of two ways: **user-first** or **item-first**. The choice as to which to use depends simply on which format is the most convenient for the particular control you want to specify. For example, if you want to specify an individual user's access rights to a variety of information, then `user-first` is the simplest way to declare the controls.

If you want to display the value of a `prescriptiveACI` attribute, use the following command:

```
dxim> show /c=us/o=abacus/cn="Access Control" attribute prescriptiveACI
```

Note that in this version of the Enterprise Directory you cannot specify a particular identification string as part of a search filter in a `SEARCH` command. The only type of searching supported is a wildcard search for all `prescriptiveACI` attributes, for example:

```
dxim> search /c=us/o=abacus where prescriptiveACI=* -
_dxim> attributes prescriptiveACI
```

Refer to Section B.1 for details of the `user-first` ACIitem format, and to Section B.2 for details of the `item-first` ACIitem format.

Refer to Section B.3 for an explanation of the different directory information items that you can specify access controls for. Refer to Section B.4 for an explanation of the different classes of directory user that you can specify access controls for. Refer to Section B.5 for an explanation of the various types of access control you can grant or deny.

### B.1 User-First ACIitems

The format of a `user-first` ACIitem is as follows:

```
<identification>
PRECEDENCE <integer>
USERS <user_list>
PERMISSIONS <grants_denials> TO <item_list> [PRECEDENCE <integer>]
    [<grants_denials> TO <item_list> [PRECEDENCE <integer>]] ...
AUTHENTICATION (NONE | SIMPLE | STRONG)
```

where:

## The PrescriptiveACI Attribute

### B.1 User-First ACIitems

<identification> is a user friendly string that identifies this ACIitem. For example, "Manager's Access Rights".

<integer> is an integer. If the DSA finds that more than one argument appears to affect a given user request, the argument with the highest precedence integer is the one that the DSA applies.

<user\_list> specifies the directory users to which this ACIitem applies. Refer to User\_list for further details.

<grants\_denials> specifies what rights are permitted and/or denied.

<item\_list> specifies the directory information items to which the <grants\_denials> apply.

You can repeat the <grants\_denials> TO <item\_list> [PRECEDENCE <integer>] argument. Each permission statement can be assigned a different precedence. A high integer indicates high precedence.

#### User\_list

The <user\_list> argument specifies the directory users to which this access control applies, as follows:

```
<user> [AND <user>] ...
```

The accepted parameters for the <user> argument are:

```
ALL
OWNER
NAMES <name_list>
GROUPS <name_list>
BEGINNING <subtree_list>
```

For example:

```
USERS NAMES /c=us/o=abacus/cn=Joan
      AND BEGINNING /c=us/o=abacus/ou=sales
      AND OWNER
```

Refer to Section B.4 for details of these user classes.

#### Grants\_Denials

The <grants\_denials> parameter specifies one or more permissions that are granted or denied.

The format of <grants\_denials> is as follows:

```
(GRANT | DENY) <permission> [, <permission>] ...
[
  AND (GRANT | DENY) <permission> [, <permission>] ...
]
```

where <permission> is one of the following:

ALL ACCESS  
ADD  
BROWSE  
COMPARE  
CREATE  
DELETE  
DISCLOSE  
EXPORT  
IMPORT  
MODIFY  
READ  
REMOVE  
RENAME  
RETURN NAME  
SEARCH

**Example:**

```
GRANT READ, CREATE, DISCLOSE, RENAME -  
  AND -  
  DENY EXPORT, IMPORT, DELETE -  
  TO <item_list>
```

In all cases, the default state of access control is that all forms of access are denied to all users for all information. In the absence of a grant, permission is assumed to be denied. Also, denials override grants of the same precedence.

Refer to Section B.5 for details of the meaning of each permission.

**Item\_List**

Specify a list of directory information items to which the permissions apply, as follows:

```
TO <item> [AND <item>]...
```

where <item> is one of:

ENTRY  
ALL TYPES  
TYPES <type\_list>  
ALL ATTRIBUTES  
ATTRIBUTES <type\_list>

Refer to Section B.3 for details of these items.

## B.2 Item-First ACIitems

The format of an item-first ACIitem is as follows:

```
<identification>  
PRECEDENCE <integer>  
ITEMS <item_list>  
PERMISSIONS <grants_denials> TO <user_list> [PRECEDENCE <integer>]  
  [<grants_denials> TO <user_list> [PRECEDENCE <integer>]]...  
AUTHENTICATION (NONE | SIMPLE | STRONG)
```

where:

<identification> is a user-friendly string that identifies this ACIitem. For example, "Manager's Access Rights".

<integer> is an integer. If the DSA finds that more than one argument appears to affect a given user request, the argument with the highest precedence integer is the one that the DSA applies.

## The PrescriptiveACI Attribute

### B.2 Item-First ACIitems

<item\_list> is the list of directory information items to which this access control item applies. For example, the list can state that this item applies to certain attributes. Refer to Section B.3 for further details.

<grants\_denials> states one or more types of access that are granted or denied.

<user\_list> specifies one or more users to whom the <grants\_denials> apply.

The <grants\_denials> TO <user\_list> PRECEDENCE <integer> argument can be repeated. Each permission statement can be assigned a different precedence.

#### Item\_list

Use the <item\_list> argument to specify a list of items to which this access control applies, as follows:

```
<item> [AND <item>] ...
```

The permitted components of an <item\_list> are:

```
ENTRY
ALL TYPES
TYPES <type_list>
ALL ATTRIBUTES
ATTRIBUTES <type_list>
```

Refer to Section B.3 for details of the item classes that you can specify.

#### Grants\_Denials

The format of <grants\_denials> is as follows:

```
GRANT | DENY <permission> [, <permission>] ...
[
  AND GRANT | DENY <permission> [, <permission>] ...
] ...
```

where <permission> is one of the following:

```
ALL ACCESS
ADD
CREATE
DISCLOSE
READ
REMOVE
DELETE
BROWSE
EXPORT
IMPORT
MODIFY
RENAME
RETURN NAME
COMPARE
SEARCH
```

#### Example:

```
GRANT READ CREATE DISCLOSE RENAME -
  AND -
  DENY EXPORT IMPORT DELETE
```

Refer to Section B.5 for details of the meaning of each permission.

### User List

Specify a list of users to which the <grants\_denials> apply, as follows:

```
<user> [AND <user>] ...
```

where each <user> is one of the following:

```
ALL  
OWNER  
NAMES <name_list>  
GROUPS <name_list>  
BEGINNING <subtree_list>
```

Refer to Section B.4 for details of these user classes.

### Example

```
PrescriptiveACI = "Restriction on Access to Password" -  
PRECEDENCE 100 -  
ITEMS -  
  ATTRIBUTES userPassword -  
PERMISSIONS -  
  DENY ALL ACCESS -  
  TO ALL -  
AUTHENTICATION NONE
```

## B.3 Item Classes

Use the following keywords to specify the directory information items to which an access control applies:

```
ENTRY  
ALL TYPES  
TYPES <type_list>  
ALL ATTRIBUTES  
ATTRIBUTES <type_list>
```

A single ACIitem can list more than one of these keywords, and some of the keywords require arguments. Refer to the subtopics for further details of each class of directory information item.

### Entry

This parameter means that the access control applies to entries, although further access rights are required to access attribute information within an entry. Access to an entry is a prerequisite for access to attribute information.

### All Types

This parameter means that the access control applies to all attribute types, but not to values of the attributes. This allows you to detect the presence of an attribute type in an entry, without being able to read or modify any values. ALL TYPES excludes operational attributes. To specify operational attributes, use the TYPES parameter (see Types) .

Note that an explicit DENY READ TO ATTRIBUTE statement overrides, for the specified attributes, a GRANT READ TO ALL TYPES statement of equal precedence. If you want to conceal values of some attributes, but permit the presence of all attributes to be detected, then you need to give the GRANT READ TO ALL TYPES statement a higher precedence than the DENY READ TO ATTRIBUTE. Refer to Types for further details.

## The PrescriptiveACI Attribute

### B.3 Item Classes

#### Types

This parameter enables you to specify which attribute types the access control applies to. You can specify operational attributes as well as user attributes. Note that the `TYPES` parameter gives no access rights to the values of attributes, only to the attribute type. This is useful for attributes such as `userPassword`, where you might want users to be able to detect the presence of an attribute, but not to see or modify its values.

Syntax:

```
TYPES <type_list>
```

Example:

```
TYPES telephoneNumber, title, commonName
```

Note that an explicit `DENY READ TO ATTRIBUTE` statement overrides a `GRANT READ TO TYPES` statement of equal precedence. If you want to conceal the values of an attribute, but permit the presence of the attribute to be detected, then you need to give the `GRANT READ TO TYPES` statement a higher precedence than the `DENY READ TO ATTRIBUTE`.

For an example of this, refer to the default access control template file. In both the "Directory Managers" and "Own Entry" ACIitems, there is a `GRANT READ TO TYPE` statement for the `userPassword` attribute. That statement has a precedence that is slightly higher than the precedence of the rest of the relevant ACIitem. This ensures that managers and entry owners can detect the presence of the attribute without being able to see its value.

#### All Attributes

This parameter means that the access control applies to all attribute information, including values. However, `ALL ATTRIBUTES` excludes operational attributes. To specify operational attributes, use the `ATTRIBUTES <type_list>` parameter (see `Attributes`).

#### Attributes

This parameter enables you to specify which attributes the access control applies to. You can specify operational attributes as well as user attributes. This parameter includes values of the attributes, unlike the `TYPES` parameter.

Syntax:

```
ATTRIBUTES <type_list>
```

Example:

```
ATTRIBUTES telephoneNumber, title, commonName
```

#### Item Classes Example

The following example shows how you can use the various items together in an access control item. The access controls apply to entries, and all user attributes. The permissions indicate that the named user is to be allowed `READ` access to these items.

```
"Example Access Value" -  
PRECEDENCE 1 -  
ITEMS -  
  ENTRY -  
  AND ALL ATTRIBUTES -  
PERMISSIONS -  
  GRANT READ ACCESS TO NAME /c=us/o=abacus/ou=sales/cn="Jon Jacks" -  
AUTHENTICATION SIMPLE
```

The above example is an item-first access control item.

The equivalent user-first access control item would be:

```
"Example Access Value" -  
PRECEDENCE 1 -  
USERS -  
  NAME /c=us/o=abacus/ou=sales/cn="Jon Jacks" -  
PERMISSIONS -  
  GRANT READ ACCESS TO -  
  ENTRY -  
  ALL ATTRIBUTES -  
AUTHENTICATION SIMPLE
```

Refer to Section B.1 for details of the syntax of a user-first access control item, and to Section B.2 for details of the syntax of an item-first access control item.

## B.4 User Classes

Use the following keywords to specify the directory users to which an access control applies:

```
ALL  
OWNER  
NAMES <name_list>  
GROUPS <name_list>  
BEGINNING <subtree_list>
```

You can specify any combination of these user classes in a single ACItem, and some of the keywords require further arguments. Refer to the subtopics for further details of the user classes.

### All

This parameter means that the access control applies to all directory users. A DSA considers all users it does not know, or for whom it has no more specific access control information, as members of the ALL category.

### Owner

This parameter means that the access control applies to the directory user who has authenticated themselves using the name of the entry that they then try to access. A possible use of this parameter would be to enable users to modify the passwords of their own directory entry, whilst passwords are generally not accessible to directory users.

### Names

This parameter specifies particular users to whom the access control applies. Specify each user using their distinguished name. If you specify a distinguished name that contains the comma character, quote the distinguished name.

In order to take advantage of the access control, users must identify themselves to the DSA (through their application) using their distinguished name. For example, when you use DXIM to bind to a DSA, you can specify your name and password. The DSA applies the access controls specified for your name, rather than treating you as a member of the ALL category.

## The PrescriptiveACI Attribute

### B.4 User Classes

#### Syntax:

```
NAMES <name_list>
```

where <name\_list> is a list of names separated by commas, as follows:

```
NAMES /c=us/o=abacus/ou=sales/cn="Jon Jacks", -  
      /c=us/o=abacus/ou=research/cn="Jenny Green", -  
      /c=us/o=abacus/ou=personnel/cn="Paolo Ginelli" -
```

#### Groups

This parameter enables you to specify the name of a `groupOfUniqueNames` entry. The `groupOfUniqueNames` entry contains an attribute that specifies the distinguished names of all members of the group.

If the DSA finds that a user is a member of such a group, then the DSA applies the access control specified for the group, rather than treating the user as a member of the ALL category.

Note that the DSA only determines the membership of groups for which the `groupOfUniqueNames` entry is held locally. If a DSA does not hold a copy of the `groupOfUniqueNames` entry, it assumes that the user is not a member of that group.

#### Syntax:

```
GROUPS <name_list>
```

where <name\_list> is a list of names separated by commas, for example:

```
GROUPS /c=us/o=abacus/ou=sales/cn="Management Team", -  
      /c=us/o=abacus/ou=research/cn="Management Team", -  
      /c=us/o=abacus/ou=personnel/cn="Management Team" -
```

#### Beginning

This parameter enables you to specify the name of a directory subtree, and to specify a portion of that subtree. The DSA applies the access control to any directory users who identify themselves to the DSA using a distinguished name that is within the subtree, or the specified portion of the subtree.

#### Syntax:

```
BEGINNING <subtree_list>
```

where <subtree\_list> is as follows:

```
<subtree>, <subtree>, ...
```

Each <subtree> is as follows:

```
<name> [<limits>]
```

where:

<name> is the name of the entry at the root of the subtree that contains the users to be affected by this access control.

<limits> is an optional parameter that specifies what portion of the named subtree is to be affected. The limits are specified as minimum and maximum integers, using the MINIMUM and MAXIMUM keywords. For example:

```
BEGINNING /c=us/o=abacus minimum 2 maximum 4 -
```



The minimum integer indicates that the access control applies to entries that are at least that many levels beneath the entry at the root of the subtree. The maximum integer indicates that the access control applies to entries that are no more than that far beneath the entry at the root of the specified subtree. By default, the access control applies to all entries in the subtree, including the entry at its root.

**Example:**

```
BEGINNING /c=us/o=abacus -
BEGINNING /c=us/o=abacus, /c=us/o=acme -
BEGINNING /c=us/o=abacus minimum 2 maximum 4, /c=us/o=acme -
```

In the last example, the limits option is used to specify that the access control affects entries at least two levels beneath the Abacus entry, and no more than four levels beneath it. For example, the entry `/c=us/o=abacus/ou=sales` is only one level beneath the Abacus entry, and is therefore unaffected by the access control.

### User Classes Example

The following example shows how you can use the various user classes together in the same `USERS` argument. The access controls apply to anyone who meets one of the following requirements:

- Is called Jon Jacks
- Is a member of the Board of Directors
- Has a distinguished name that is within the research subtree
- Is the owner of the entry that is currently being accessed.

```
"Example Access Value" -
PRECEDENCE 1 -
USERS -
  OWNER -
  AND NAMES /c=us/o=abacus/cn="Jon Jacks" -
  AND GROUPS /c=us/o=abacus/cn="Board of Directors" -
  AND BEGINNING /c=us/o=abacus/ou=research minimum 2 maximum 5 -
PERMISSIONS -
  GRANT ALL ACCESS TO
  ENTRY -
  ALL ATTRIBUTES -
AUTHENTICATION SIMPLE
```

The above example is a user-first access control item.

The equivalent item-first access control item would be:

```
"Example Access Value" -
PRECEDENCE 1 -
ITEMS -
  ENTRY -
  AND ALL ATTRIBUTES -
PERMISSIONS -
  GRANT ALL ACCESS TO -
  OWNER -
  NAMES /c=us/o=abacus/cn="Jon Jacks" -
  GROUPS /c=us/o=abacus/cn="Board of Directors" -
  BEGINNING /c=us/o=abacus/ou=research -
AUTHENTICATION SIMPLE
```

## The PrescriptiveACI Attribute

### B.5 Permissions

## B.5 Permissions

X.500 allows you to control access to entries, and to particular attributes.

The range of permissions provided by the Enterprise Directory reflects the range of its services. You can control the ability to search the directory, to compare attribute values, to create or delete entries or attributes, to modify attributes, and rename entries. You can also control what information is returned to the user in the event that they are refused access to the information they ask for. For example, if a user is not allowed to show an entry, the Enterprise Directory might state that the entry does not exist, rather than returning an "insufficient privileges" message.

The complete list of permissions is as follows:

```
ALL ACCESS
ADD
BROWSE
COMPARE
CREATE
DELETE
DISCLOSE
EXPORT
IMPORT
MODIFY
READ
REMOVE
RENAME
RETURN NAME
SEARCH
```

Refer to the following subtopics for further details.

### **All Access**

The ALL ACCESS permission is a shorthand way of specifying all permissions.

Refer to the individual permission topics for details of each permission.

### **Add**

The ADD permission controls the creation of entries and attributes.

To create an entry, you need permission to add an entry, and you also need permission to add the attributes and values of the entry. If you do not have permission to add attributes, you will be unable to create an entry even though you have permission for that aspect of the operation.

Typically, a directory manager would have permission to add entries, and to add all user attributes. A directory manager might also have permission to add operational attributes.

An end user would typically not have permission to add entries, but might have permission to add some attributes to their own entry.

Note that in order to modify existing entries, you also need the MODIFY permission. Without the MODIFY permission, you can only add and remove attributes and values of entries as you create them.

A manager will typically have the ADD and MODIFY permissions for entries, as well as the ADD permission for attributes and values. However, a user might have permission to modify only their own entry, and permission to add and remove attributes of their own entry, but no permission to add new entries or modify other people's entries.

### Browse

The `BROWSE` permission allows you to use operations that can display more than one directory entry.

For example, the `BROWSE` permission is required for list operations, such as the `DXIM SHOW SUBORDINATES` command. List operations also require the `RETURN NAME` permission.

The `BROWSE` permission is also required for search operations, such as the `DXIM SEARCH` command, and the Show Subordinates option of the `DXIM` windows interface. Search operations also require the `RETURN NAME`, `READ`, and `SEARCH` permissions. Refer to the relevant sections for further details.

### Compare

The `COMPARE` permission enables you to detect the existence of an attribute value in an entry. The `READ` permission to entries is also required for such operations. The `COMPARE` permission is useless without `READ` to entry.

For example, consider the following `DXIM` command:

```
dxim> compare /c=US with description=big
```

In order for that command to succeed, the manager requires permission to read entries, and to compare the description attribute (or all attribute types).

For example, the following extract from an access control item provides the required permissions:

```
GRANT -  
  READ TO ENTRY -  
  AND -  
  COMPARE TO ATTRIBUTE description
```

The statement "`COMPARE TO ATTRIBUTE description`" includes all values of that attribute.

### Create

The `CREATE` permission is identical to the `ADD` permission. Refer to the `ADD` permission for details.

### Delete

The `DELETE` permission is identical to the `REMOVE` permission. Refer to the `REMOVE` permission for details.

### Disclose

The `DISCLOSE` permission allows you to control whether the existence of directory information is revealed in the event of an error. If the permission is not granted, a user is told that the information does not exist, rather than being told that they failed to access it.

For example, if a user attempts to read an attribute value for which they have no access rights, the directory can tell the user that the attribute is not present. For some directory information, the ability to detect its existence may in itself be considered a security risk.

You can grant or deny the permission to `DISCLOSE` for entries and attribute types.

Note that the disclosure only applies in the case of an error. The user might have permission to read an attribute, but not have the right to modify it. In that case, a user without the `DISCLOSE` permission can be told that the attribute does not exist when they use the `MODIFY` command, even though they can successfully display it using `SHOW` commands.

## The PrescriptiveACI Attribute

### B.5 Permissions

#### Export

The `EXPORT` permission enables you to control whether an entry can be renamed from one point in the DIT to another. The `IMPORT` permission is required at the new location. The `EXPORT` permission permits all subordinates to the entry being renamed collectively. This enables an entire subtree of the DIT to be moved.

Note that Compaq's DSAs do not support the renaming of entire subtrees from one point in the DIT to another.

See also the `IMPORT` permission.

#### Import

The `IMPORT` permission enables you to control whether an entry can be renamed to a particular point in the DIT. The `EXPORT` permission is required at the old location of the entry. The `IMPORT` permission enables all subordinates of an entry to be renamed collectively. This enables an entire subtree of the DIT to be moved.

Note that Compaq's DSAs do not support the renaming of entire subtrees from one point in the tree to another.

See also the `EXPORT` permission.

#### Modify

The `MODIFY` permission enables you to control whether entries can be modified. If the `MODIFY` permission is granted, you can modify entries, although you also need the `ADD` or `REMOVE` permissions for the particular attributes that you intend to modify. The `MODIFY` permission on its own is useless.

See also the `ADD` and `REMOVE` permissions.

#### Read

The `READ` permission enables you to control whether directory information can be returned to the user as part of the results of directory requests. The `READ` permission can be specified with regard to entries, attribute types, and attribute values. The `READ` permission affects, for example, the `DXIM COMPARE`, `SHOW`, and `SEARCH` commands.

The permission to read entries does not in itself permit you to read the attributes and values of entries. You also need some combination of `READ` permission `TO TYPES`, and/or `TO ATTRIBUTES` in order to receive information from entries.

Typically, a manager would have permission to read all directory information, except for certain exclusions stated using `DENY` statements. For example, the following extract from an access control item illustrates how a manager might be denied access to certain attribute types.

```
GRANT -  
  READ TO ENTRY ALL ATTRIBUTES -  
DENY -  
  READ TO TYPE userPassword
```

#### Remove

The `REMOVE` permission enables you to control the deletion of entries, attribute types, and attribute values.

To delete an entry, you need the `REMOVE` permission to entries. You can delete an entry without necessarily having permission to remove the various attributes and values within the entry.

To remove attributes and values within an entry, you need the appropriate combination of REMOVE permissions TO TYPES, and/or TO ATTRIBUTES. permissions. Note that the removal of attributes and values also requires the MODIFY permission to entries. REMOVE permission to entries is not a prerequisite of removing attributes and values.

### Rename

The RENAME permission enables you to control the renaming of entries.

The RENAME permission, if granted, enables you to change the last relative distinguished name of an entry.

The RENAME permission allows you to add attributes to an entry and remove attributes from an entry regardless of whether you have the MODIFY, ADD and REMOVE permissions normally required for those operations. The permission to rename an entry even overrides denials of permission to modify entries.

For example, the following DXIM command involves the addition of the attribute value commonName=Jones, and the deletion of the attribute value commonName=Smith, but does not require any permission other than RENAME.

```
dxim> rename /cn=Smith to /cn=Jones remove old
```

The command succeeds even if there are denials of permission to modify entries, or add commonName or remove commonName.

### Return Name

The RETURN NAME permission enables you to control whether the distinguished names of entries are returned to users as a result of directory requests.

The permission affects read, search, and list operations, that is, DXIM SHOW, SEARCH, and SHOW SUBORDINATES commands.

For requests in which the Enterprise Directory might return more than one entry (SEARCH and SHOW SUBORDINATES commands), denying this permission prevents the request from returning any information. This permission is therefore required for the successful use of those operations.

For operations that can only return a single entry (SHOW commands), this permission determines whether the distinguished name of the entry is returned in the event that you specify an alias name in a request. If the permission is denied, and you specify an alias name in a SHOW command, then you receive no indication that the name you specified was an alias name. If the permission is granted, then the distinguished name of the entry is displayed, regardless of whether you specified an alias name. In either case, assuming that other relevant permissions are granted, such as READ permission to entries, the entry is displayed.

This permission can therefore conceal from users the distinguished names of entries. This might be suitable for external users of your information, to whom you do not want to reveal the true structure of your organizational DIT.

### Search

The SEARCH permission enables you to control which attribute types can be used in search filters, and whether values can be searched for.

The BROWSE and RETURN NAME permissions are prerequisites for search operations.

You can specify the SEARCH permission with regard to attribute types or to attribute values.

## The PrescriptiveACI Attribute

### B.5 Permissions

Granting the SEARCH permission to types enables you to include the permitted types in a search filter, but in itself does not allow you to specify particular values. You could only search for all entries that have, for example, a surname attribute, regardless of its value.

Granting the SEARCH TO ATTRIBUTES permission enables you to include types and values of the permitted attribute types.

See also the BROWSE and RETURN NAME permissions.

### B.6 Access Control Template File

This section contains the access control template file that Compaq provides as a suggested default for implementing access control. Note that because there are four ACIitems, the PrescriptiveACI values are enclosed by parentheses.

On DEC OSF/1 systems, this file is called /var/dxd/scripts/dxd\_aci\_template.dxim. On OpenVMS systems, the template file is called DXD\$DIRECTORY:DXD\$ACI\_TEMPLATE.DXIM.

```
### Default access control template.
###

create entry                -
  attribute objectClass=(accessControlSubentry, subentry)

set entry                   -
  attribute prescriptiveACI = -
- #
- # The following ACI specifies the distinguished names of users
- # who are to act as directory managers. These users can create,
- # delete and modify entries anywhere in the subtree for which
- # the ACI applies.
- # They can also read and modify (where appropriate) certain
- # operational attributes.
- #
  ( -
    "Directory Managers" -
    precedence 200      -
    user names          -
    permissions         -
      grant all access to -
      entry and         -
      all attributes and -
      attributes        -
      prescriptiveACI,  -
      dseType,          -
      dxdUid,           -
      governingStructureRule, -
      subordinateDeletedTimestamp, -
      trustedDSAName    -
      deny read to      -
      attributes userPassword -
      grant read to     -
      type userPassword precedence 201 -
      authentication simple, -
- #
- # Users can check the passwords of other users. This permission
- # is used for the security of the Enterprise Directory itself. DSAs
- # must be able to check each other's passwords.
```

## The PrescriptiveACI Attribute B.6 Access Control Template File

```
- #
"Authenticated Users" -
precedence 160 -
users all -
permissions -
    grant compare to attribute userPassword -
authentication simple, -
- #
- # Users are allowed to browse and search the directory tree and
- # read all user attributes except those specifically excluded.
- #
"Unauthenticated users" -
precedence 150 -
users all -
permissions -
    grant read, browse, search, return name, disclose, compare -
to -
    entry and -
    all attributes and -
    attributes -
    -
    createTimestamp, -
    modifyTimestamp, -
    governingStructureRule -
    -
    deny all access to attributes -
    -
    -
    userPassword -
authentication none, -
- #
- # The following ACI specifies additional access rights a user
- # has to their own entry, provided they have authenticated to
- # the Enterprise Directory (using their password).
- # Specifically it specifies a set of attributes that a user
- # is allowed to add to or change in their own entry.
- #
"Own entry" -
precedence 150 -
users owner -
permissions -
    grant modify to entry -
    grant all access to attributes -
commonName, -
description, -
presentationAddress, -
protocolInformation, -
    supportedApplicationContext -
    grant compare, add, remove -
to attribute userPassword -
    grant read to type -
        userPassword precedence 151 -
authentication simple -
)
```





---

# Glossary

**ACItem**

See Access Control Information Item

**Access Control Information Item**

An access control information item (ACItem) is stored in the directory, and specifies which users can use which services on what directory information. There can be many ACItems in the directory, controlling access to different parts of the directory information tree.

**AE Title**

See Application Entity Title

**Alias Entry**

An entry that provides alias names for other entries in the Directory.

**API**

Application Programming Interface.

**Application Entity**

A software application, or a part of an application that provides a particular function. An X.500 DSA is an example of an application entity.

**Application Entity Title**

An unambiguous name that uniquely identifies an application entity, such as a DSA.

**ASN.1**

Abstract Syntax Notation One. The standardised language used to define abstract syntaxes.

**Attribute**

In X.500, an attribute is a characteristic of an X.500 entry. It comprises an attribute type and one or more attribute values. For example, `surname=Smith` is an attribute comprising the attribute type `surname` and the attribute value `Smith`.

In Compaq's enterprise management architecture, an attribute is a characteristic of a management entity. For example, the DSA entity has several attributes that enable you to manage the DSA software.

**Bind Request**

A request used to establish a connection between a DUA and a DSA, or between two DSAs.

**Browsing**

A method of exploring the directory information tree using a windows interface. The DXIM windows interface enables a user to click on entries to expose their attributes, or to expose or conceal the entries beneath a selected entry.

**Chaining**

The operation whereby a user request is passed from one DSA to another. A DSA only chains a request if it cannot satisfy the request completely itself. A DSA uses knowledge information to determine which other DSA to pass the request to. See also Multicasting and Knowledge Information.

**Consumer DSA**

A DSA that receives naming contexts from another DSA during replication. See also Supplier DSA.

**DAP**

See Directory Access Protocol.

**Dereferencing**

The process whereby a DSA uses an alias entry to determine the name of a real entry.

**DIB**

See Directory Information Base.

**Compaq's X.500 Information Management utility**

A directory application used for managing entries held in the Directory. The Compaq X.500 Information Manager (DXIM) has a command line interface and a windows interface. DXIM uses the standard Directory Access Protocol (DAP) to communicate with Directory System Agents. See Directory Access Protocol and Directory System Agent.

**Directory**

A standardized information system designed to meet the information requirements of network applications.

**Directory Access Protocol**

The standardised application layer protocol used in communication between a DUA and a DSA. This protocol is defined as part of the X.500 recommendations. It uses the ROSE and ACSE common application service elements. See also Lightweight Directory Access Protocol.

**Directory Entry**

An entry in the X.500 directory. The entry represents a specific object, and has attributes that contain information about the object. For example, an entry could represent an organization, and contain the organization's address, telephone number, a description of its business interests.

**Directory Information Base**

The information contained within an X.500 directory.

**Directory Information Shadowing Protocol**

A standardised protocol used in communication between Directory System Agents (DSAs) for replicating (shadowing) directory information. See Directory Operational Binding Protocol and Shadowing.

**Directory Information Tree**

The hierarchical structure of the directory information base.

**Directory Operational Binding Protocol**

A standardised protocol used in communication between Directory System Agents (DSAs) to establish and manage operational agreements. Specifically, Compaq DSAs use this protocol to establish shadowing agreements. The actual shadowing is implemented using the Directory Information Shadowing Protocol. See Directory Information Shadowing Protocol and Shadowing and Shadowing Agreements.

**Directory System Agent**

The part of the directory that is responsible for satisfying user requests. It either does this itself, or by communicating with other DSAs. Each DSA may hold part of the DIB.

**Directory System Protocol**

A standardised protocol used in communication between Directory System Agents (DSAs) to satisfy user requests for directory information. It uses the ROSE and ACSE common application service elements. See also the Directory Access Protocol (DAP), the Directory Information Shadowing Protocol (DISP), and the Directory Operational Binding Protocol (DOP).

**Directory User Agent**

The DUA represents a user (an application or person) to the Directory Service. It provides the interface between the user and the DSA, using a standardized directory access protocol. All users must access the Directory using a DUA. DXIM is an example of an application that includes a DUA.

**Distinguished Name**

A name that uniquely identifies a directory entry. It is made up of a series of Relative Distinguished Names. See also Relative Distinguished Name and Distinguished Value.

**Distinguished Value**

An attribute value that is used in the Relative Distinguished Name of a directory entry.

**DISP**

See Directory Information Shadowing Protocol.

**DIT**

See Directory Information Tree.

**DOP**

See Directory Operational Binding Protocol.

**DSA**

See Directory System Agent.

**DSP**

See Directory System Protocol.

**DUA**

See Directory User Agent.

**DXIM**

See Compaq's X.500 Information Management utility.

**Entry**

See Directory Entry.

**Entity**

An individual, manageable component of a network or a distributed system. For example, by subdividing a network into entities, it allows that network to be easily managed and controlled. See also Subentity.

**Filter**

See Search Filter.

**Knowledge Information**

Information held by a DSA about the entries it holds and about the network addresses of DSAs that hold other parts of the directory information base.

**LDAP**

See Lightweight Directory Access Protocol

**Lightweight Directory Access Protocol**

A simplified alternative to the X.500 Directory Access Protocol. The LDAP V2 protocol is defined by RFC1487 and LDAP V3 is defined by RFC2251. LDAP requires fewer resources than DAP, enabling directory applications to be supported on smaller systems.

**Master Copies**

Entries that are not copied to this DSA from some other DSA. See also Shadow Copies, Shadow DSA, and Master DSA.

**Master DSA**

A DSA that holds the master copy of one of more directory entries. See also Shadow DSA.

**Multicasting**

The operation whereby a DSA distributes a request simultaneously to multiple DSAs that might be able to help satisfy a user request. See also Chaining.

**Naming Context**

A part of the directory information tree. Dividing the DIT into naming contexts enables it to be distributed amongst several DSAs. This ensures that the DIT is scalable. A DSA can hold more than one naming context, and a naming context can contain any number of directory entries.

**Object**

Something that is represented by a directory entry, such as a person, company, printer, or software application.

**Object Class**

The class to which a directory entry belongs. For example, Compaq could be represented by a directory entry of the object class *organization*. All directory entries are classified. The set of attributes that a directory entry can contain is determined by its classification.

**Object Identifier**

A sequence of numeric identifiers that uniquely identifies a standardized definition. For example, all X.500 object classes are assigned a unique object identifier.

**OSAK**

OSI Application Kernel. Part of Compaq's DECnet-Plus product that provides OSI conformant transport and session services that act as a basis for developing applications to interconnect across an OSI network or TCP/IP network using RFC1006. Note that on OpenVMS systems it is necessary to install OSAK separately, but on Tru64 UNIX systems OSAK is automatically part of DECnet-plus.

**Presentation Address**

An address that uniquely identifies an application, such as a DSA.

**Primary Shadowing**

During replication, the process of taking shadow copies of master copies. See also Shadowing, Secondary Shadowing and Shadowing Agreements.

**RDN**

See Relative Distinguished Name.

**Reference**

Information that identifies a DSA that holds part of the directory information base.

**Referral**

Information provided to a user by a DSA that cannot satisfy a user request. The referral identifies another DSA which might be able to satisfy the request. The user can use the information to attempt to connect to the other DSA and repeat their request.

**Relative Distinguished Name**

A name that identifies a particular directory entry. The RDN is unique relative to that entry's immediately superior entry. See also Distinguished Name and Distinguished Value.

**Replication**

The process of copying directory information from one DSA to another. See also Shadowing, Shadowing Agreements, Primary Shadowing, and Secondary Shadowing.

**Request Decomposition**

An internal operation performed by a DSA whereby a request is divided into a number of smaller requests such that each of these subrequests perform a part of the original request.

**RFC1006**

A protocol encapsulation that allows OSI network PDUs to be transferred over a TCP/IP network. RFC1006 functionality is provided by DECnet-Plus.

**ROSE**

Remote Operations Service Element. An OSI common application service element that provides a standard service and protocol framework over which certain interactive application services and protocols may be defined.

**Search Filter**

The part of a search request that defines what directory information a user wants to search for.

**Secondary Shadowing**

During replication, the process of taking shadow copies of shadow copies. See also Shadowing, Primary Shadowing, and Shadowing Agreement.

**Service Controls**

A group of parameters that can be applied to user requests to influence the processing of an operation, and the results obtained. Typical service controls specify a time limit and whether the DSA is permitted to contact other DSAs.

**Shadow Copies**

Directory entries that are held by a DSA as copies of entries held by some other DSA. See also Shadow DSA, Master DSA and Master Copies.

**Shadow DSA**

A DSA that hold entries that it has copied from other DSAs. See also Shadow Copies, Master Copies and Master DSA.

**Shadowing**

The process of copying or replicating directory information from one DSA to another in accordance with a shadowing agreement. A DSA that provides copies of directory information is called a supplier DSA, and a DSA that takes copies is called a consumer DSA. X.500 shadowing must not be confused with concepts such as disk shadowing. See Shadowing Agreements, Primary Shadowing, and Secondary Shadowing.

**Shadowing Agreement**

A specification of a shadowing relationship between two DSAs. The agreement specifies which DSA is the supplier DSA and which is the consumer DSA. It also specifies such details as how frequently shadowing should occur. Shadowing agreements are established and maintained using the standard Directory Operational Binding Protocol. See Shadowing, Directory Operational Binding Protocol, Supplier DSA and Consumer DSA.

**Subentity**

In Compaq's enterprise management architecture, an entity that is subordinate to another entity. For example, the Naming Context entity is a subentity of the DSA entity.

**Subordinate Reference**

Knowledge information held by a DSA. The information identifies directory information that is subordinate to information held by this DSA. The information also states the network address of the DSA or DSAs that hold the subordinate directory information.

**Superior Reference**

Knowledge information held by a DSA. The information identifies the network address of a DSA that holds directory information that is superior to directory information held by this DSA.

**Supplier DSA**

The DSA which is the provider of naming contexts during replication. See also Consumer DSA.

**Trusted DSA**

A DSA that is considered by a given DSA to be a member of the security domain. Trust is a prerequisite for replication between Compaq DSAs. Trusted DSAs also act consistently with regard to user authentication, such that a user who authenticates to one DSA has effectively authenticated to all other DSAs that are trusted by that DSA. A DSA honours the authentication level claimed for a user by a trusted DSA. This saves a user from having to authenticate specifically to each DSA that contributes to the satisfaction of their requests.

**X.400**

The series of recommendations that define an open Message Handling System.

**X.500**

The series of recommendations that define an open Directory Service.





## A

---

abstract services  
    *See* enterprise directories

access control, 1-12, 7-1  
    chained requests, 4-18  
    DSA trust requirement, 4-18  
    in distributed operations, 4-18  
    item classes, 7-6  
    overview, 7-1  
    permissions, 7-7  
    recommendations, 7-2  
    specifying what information an ACIitem affects, 7-6  
    specifying what types of request an ACIitem affects, 7-7  
    specifying what users an ACIitem affects, 7-6  
    template  
        description, 7-3  
        usage, 11-1  
    template file, 7-1  
    user classes, 7-6

accounting, 1-12

ACIitems  
    *See* access control, 7-1

AE titles, 5-10  
    setting, 8-5

alias entries  
    definition of, 1-5

application defaults, 9-1

application entity titles, 5-10

applications  
    defaults file, 9-1

attribute  
    defining, 6-1

attributes, 1-2, 1-3  
    default definitions, A-25  
    defining, 6-12  
    indexing for matching, 6-15  
    mandatory attributes, 1-6  
    matching rules, 6-12  
    multi-valued, 6-13, 6-14  
    normalization, 6-12  
    optimizing for matching, 6-15  
    optional attributes, 1-6  
    ordering of values, 6-12, 6-14  
    single valued, 6-13, 6-14

attributes (cont'd)  
    syntaxes, 1-3  
        matching rules, 1-3  
    types, 1-2, 1-3  
    values, 1-2, 1-3

attribute size limit  
    DUA default, 9-6

auxiliary classes  
    defining, 6-9  
    DXIM windows support, 6-12

## B

---

bulk entry management, 10-5

## C

---

chaining, 1-11

classes, 1-6, 1-9  
    auxiliary, 6-1  
    default definitions, A-1  
    defining, 6-1  
    mandatory attributes, 1-9  
    name forms, 1-6, 1-9  
    optional attributes, 1-9  
    planning  
        aliases classes, 6-26  
        auxiliary classes, 6-9  
        structural classes, 6-19  
    planning classes to represent objects, 4-10  
    structural, 6-1  
    structure rules, 1-6, 1-7, 1-9

client  
    *See* Directory User Agent

configuration tutorial  
    multi-node, 3-1  
    single node, 2-1

consumer initiated replication, 8-20

context prefix  
    *See* superior reference

copy shall do  
    DUA default, 9-6

CREATE DSA, 8-5

## D

---

### database

- defragmentation, 8–23

### decDSA entries

- attributes, 5–17
- role in chained operations, 4–18
- role in replication, 4–18
- role in security, 4–18
- trust, 5–17

### defaults files, 9–1

### defining attribute types, 6–12

### defragmenting the database files, 8–23

### DELETE DSA, 8–22

### directory entries, 1–1

- See* entries

### directory information

- access control, 1–12, 7–1
- distribution of, 1–9, 5–1, 5–5
- introduction, 1–1
- management of, 1–12
- replication of, 1–9, 5–2, 5–6
- schema, 1–9
- security, 1–12

### directory information tree

- planning, 4–1
- positioning in a global context, 4–13

### Directory Information Tree, 1–1

- access control, 7–1

### directory names

- definition of, 1–3

### directory schema

- See* schema

### directory server

- See* Directory System Agent

### directory software components, 1–8

- management of, 1–12, 1–13

### Directory System Agent

- AE titles, 5–10
- configuring, 8–1
- creating, 8–5
- creating Naming Contexts, 8–7
- creating Subordinate References, 8–8
- creating Superior References, 8–9
- definition, 1–8
- disabling, 8–21
- DUA default, 9–8
- enabling, 8–10
- example configuration, 2–1, 3–1
- LDAP Port, 5–11
- management of, 1–13
- managing LDAP, 8–7
- master DSA, 5–2
- password, 5–10
- presentation addresses, 5–11
- replicating information, 8–13

### Directory System Agent (cont'd)

- representing as a directory entry, 4–18
- security planning, 4–18, 5–6
- setting AE titles, 8–5
- setting passwords, 8–6
- setting presentation addresses, 8–6
- setting volatile modifications, 8–6
- shadow DSA, 5–2
- shadowing agreements, 8–16
- shadowing information, 8–13
- startup procedures, 8–22
- trusted DSA name
  - alternative method, 7–10
  - recommended method, 5–17
- trust planning, 4–18
- updating naming contexts, 8–13

### Directory User Agent

- definition of, 1–8
- management of, 1–13

### DISABLE DSA, 8–21

### distinguished name, 1–3

- definition of, 1–4

### distinguished value, 4–15

### distributed information, 1–9

### distributed services, 1–11

### distribution, 5–1, 5–5

### DIT

- See* Directory Information Tree, 1–1

### domain root

- DUA default, 9–5

### DSA

- See* Directory System Agent

### DUA

- See* Directory User Agent

### DUA.AttributeSizeLimit, 9–6

### DUA.CopyShallDo, 9–6

### DUA.DomainRoot, 9–5

### DUA.InitialEntry, 9–6

### DUA.KnownDSAs.paddr, 9–8

### DUA.Priority, 9–5

### DUA.Requestor, 9–7

### DUA.ScopeOfReferral, 9–4

### DUA.SizeLimit, 9–5

### DUA.TimeLimit, 9–4

### DXD\$COMMON\_STARTUP.COM, 8–22

### DXD\$DSA\_STARTUP.NCL, 8–22

### DXIM, 1–12

- See* utilities

- defaults file, 9–1

- defining keywords, 6–17

- example of entry creation, 3–10

- running, 9–9

- support of auxiliary classes, 6–12

- window definitions, 6–25

- DXIM script files, 10–2

## E

---

- ENABLE DSA, 8–10
- enabling DSAs, 8–10
- enterprise directories
  - access control, 1–12
  - accounting, 1–12
  - interrogation services, 1–8
  - introduction, 1–8
  - management of, 1–12
  - modification services, 1–8
- Enterprise Directory
  - illustration, 1–8
- Enterprise Management Architecture, 1–13, 5–9
- entries, 1–1, 1–2
  - access control, 1–12
  - alias entries, 1–5
  - bulk management, 10–5
  - creating interactively, 10–4
  - creating with script files, 10–2
  - entries and shadow copies, 5–2
  - management of, 1–12
  - multiple selection, 10–5
  - names, 1–2, 1–3, 4–15
  - representing DSAs, 4–18

## F

---

- files
  - reading entries from files, 10–5
  - writing entries to files, 10–5
- filters, 6–28
  - fields, 6–31

## G

---

- global prefix, 4–13

## I

---

- indexing attributes, 6–15
- initial entry
  - DUA default, 9–6

## K

---

- keywords
  - defining, 6–17
- knowledge information, 1–9, 1–11
  - naming contexts, 5–9, 5–11
  - planning, 5–9
  - subordinate reference, 5–9, 5–14
  - superior reference, 5–9, 5–16
- known DSAs
  - DUA default, 9–8

## L

---

- labels for schema definitions, 6–17
- LDAP, 1–8
  - connection to DSA, 3–9
  - displaying name convention, 1–5
  - labels, 6–17
  - setting port, 8–7
  - use of, 1–12
- Lightweight Directory Access Protocol, 1–8
- Lookup Client, 3–3, 3–9
  - configuration utility, 9–9
  - defaults file, 9–1, 9–9
  - starting, 3–21, 9–11

## M

---

- MAILbus 400 MTA
  - defaults file, 9–1
- management utilities
  - defaults files, 9–1
  - running, 9–9
- managing multiple entries, 10–5
- mandatory attributes, 1–6
- master DSAs, 5–2, 5–5
- matching rules
  - indexing attributes to optimize matching, 6–15
  - reference material, A–63
- memory image files
  - defragmentation, 8–23
- moving subtrees, 10–5
- multiple entry management, 10–5
- multi-valued attributes
  - defining, 6–13
  - ordering of values, 6–13, 6–14

## N

---

- name forms, 1–6, 4–15
  - defining, 6–22
- names, 1–2
  - based on geography, 4–2
  - based on organizational structure, 4–2
  - planning, 4–15
    - guidelines, 4–1
    - resolving name clashes, 4–16
- naming attributes, 4–15
- naming authority, 4–1
- naming contexts, 5–3, 5–5, 5–6
  - access control, 7–1
  - configuring, 8–7
  - consumer information, 5–12
  - entity, 5–11
  - illustration of, 5–1
  - introduction, 1–9
  - naming, 5–4
  - planning, 5–1

## naming contexts (cont'd)

- populating, 10–2
  - primary shadow information, 5–12, 8–13
  - replicating, 8–13
  - secondary shadow information, 5–12, 8–13
  - terminating shadowing, 8–21
  - updating, 8–13
- normalization of attributes, 6–12

## O

---

- object classes
  - See* classes
- object identifiers
  - assigning, 6–7
- objects, 1–1
- OnChange replication, 8–20
- optional attributes, 1–6

## P

---

- password, 5–10
- passwords
  - setting DSA passwords, 8–6
- presentation addresses, 5–11
  - setting, 8–6
- primary shadowing
  - implementing, 8–13
  - planning, 5–12
- priority
  - DUA default, 9–5

## R

---

- RDN
  - See* relative distinguished name
- reading information from files, 10–5
- referral scope
  - DUA default, 9–4
- relative distinguished name, 1–3
  - definition of, 1–4
- renaming subtrees, 10–5
- replication, 1–10
  - implementing primary and secondary shadows, 8–13
  - notes about managing agreements, 8–17
  - OnChange configuration, 8–16
  - planning, 5–2, 5–6
  - role in security, 4–19
  - role of decDSA entries, 4–18, 5–6
  - schedule configuration, 8–16
  - terminating, 8–21
- requestor
  - DUA default, 9–7

## S

---

- schema
  - alias classes, 6–26
  - attributes, 6–12
  - auxiliary classes, 6–8
  - case studies, 6–8
  - compiling, 6–2, 6–5
  - copying, 6–2
  - customizing, 1–9, 6–1
  - directory location, 6–2
  - display rules, 1–9
  - introduction, 1–9
  - labels, 6–17
  - mandatory attributes, 1–9
  - name forms, 1–9, 6–22
  - optional attributes, 1–9
  - planning customizations, 6–8
  - search filters, 6–28
  - structural classes, 6–8
  - structure rules, 1–9, 6–23
  - text files, 6–2
- scope of referral
  - DUA default, 9–4
- script files, 10–2
- search filters, 6–28
  - fields, 6–31
- secondary shadowing
  - implementing, 8–13
  - planning, 5–12
- security, 1–12
  - planning, 4–18, 5–6
- selecting entries, 10–5
- server
  - See* Directory System Agent
- SET DSA LDAP PORT, 8–7
- shadow copies, 5–2
- shadow DSAs, 5–2, 5–6
  - primary shadowing, 5–6
  - secondary shadowing, 5–6
- shadowing, 1–10
  - consumer initiated configuration, 8–20
  - forcing immediate updates, 8–20
  - identifying agreements, 8–17
  - identifying initiators, 8–18
  - implementing primary and secondary shadows, 8–13
  - notes about managing agreements, 8–17
  - OnChange configuration, 8–16, 8–20
  - planning primary and secondary shadows, 5–12
  - reinstating default behaviour, 8–20
  - schedule configuration, 8–16, 8–19
- shadowing agreements, 8–15, 8–16
- single valued attributes
  - defining, 6–13

- size limit
  - DUA default, 9-5
- structural classes
  - defining, 6-19
- structure rules, 1-7
  - defining, 6-23
  - quick reference, A-23
- subentries
  - differences from normal entries, 7-2
  - hiding from users, 7-2
  - shadowing agreements, 8-16
- Subordinate Reference entity, 5-14
- subordinate references
  - configuring, 8-8
- subtrees
  - moving, 10-5
  - renaming, 10-5
  - selecting, 10-5
- Superior Reference entity, 5-16
- superior references
  - configuring, 8-9
- syntaxes
  - reference material, A-56

## T

---

- time limit
  - DUA default, 9-4
- tree structure, 1-1
- trust
  - planning, 4-18
- trusted DSA name
  - alternative method, 7-10
  - recommended method, 4-18, 5-17
- tutorial, 2-1, 3-1

## U

---

- UPDATE DSA
  - use in V2.0, 8-13
- updating shadow DSAs, 8-13
- utilities
  - command line interface, 1-12
  - windows interface, 1-12

## V

---

- volatile modifications
  - setting, 8-6

## W

---

- window definitions, 6-25
- writing entries to files, 10-5

