

Storage Library System for OpenVMS

Guide to Backup and Restore Operations

Order Number: AA-QHLEN-TE

Abstract

This document contains information for performing backup, archive, and restore operations using Storage Library System for OpenVMS(SLS) software.

Revision/Update Information: This revised document supersedes the previous release of this document
(Order Number AA-QHLEM-TE)

Software Version: Storage Library System for OpenVMS
Version 2.9H

Hewlett-Packard Company
Palo Alto, California

January 2004

© 2004 Hewlett-Packard Development Company, L.P

Confidential computer software. Valid license from HP and/or its subsidiaries required for possession, use, or copying.

Consistent with FAR 12.211 and 12.212, Commercial Computer Software, Computer Software Documentation, and Technical Data for Commercial Items are licensed to the U.S. Government under vendorial license.

Neither HP nor any of its subsidiaries shall be liable for technical or editorial errors or omissions contained herein. The information in this document is provided "as is" without warranty of any kind and is subject to change without notice. The warranties for HP products are set forth in the express limited warranty statements accompanying such products. Nothing herein should be construed as constituting an additional warranty.

Printed in the U.S.A.

Contents

Preface	xxi
----------------------	------------

1 Introduction to Storage Library System for OpenVMS

1.1 SLS Storage Management Concepts	1-1
1.1.1 Why You Save Data	1-1
1.1.1.1 Backup Copy of Data	1-1
1.1.1.2 Archive Copy of Data	1-2
1.1.1.3 Defining Data Safety Policy	1-2
1.1.1.4 Policy Implementation and Administration	1-2
1.2 Storage Management Responsibilities	1-2
1.2.1 Storage Administrator's Responsibilities	1-3
1.2.2 Operator's Responsibilities	1-3
1.2.3 User's Responsibilities	1-4

2 Using SLS Menu Interfaces

2.1 SLS Menus	2-1
2.2 Administrator Menu	2-1
2.2.1 Accessing the Administrator Menu	2-1
2.2.2 Administrator Menu Diagram	2-2
2.2.3 Administrator Menu Options	2-2
2.3 Operator Menu	2-2
2.3.1 Accessing the Operator Menu	2-2
2.3.2 Operator Menu Diagram	2-2
2.3.3 Operator Menu Options	2-3
2.4 User Menu	2-4
2.4.1 Accessing the User Menu	2-4
2.4.2 User Menu Diagram	2-4
2.4.3 User Menu Options	2-5

3 SLS Processes and Database Management

3.1 The SLS Server and Client Processes	3-1
3.1.1 Client and Server Definitions	3-1
3.1.2 Basic Block Diagram of SLS Server and Client Processes	3-2
3.2 The SLS Server Process in a OpenVMS Cluster System	3-3
3.2.1 Establishing the Active Server Node	3-3
3.3 SLS Client Process in the OpenVMS Cluster System	3-3
3.3.1 Establishing a Client Connection on a OpenVMS Cluster System	3-4
3.3.2 DFS Restrictions Using VMS Backup Utility	3-7
3.4 How to Define the SLS Server Process	3-9
3.5 How to Define the Client-Server Process Connection Timeout Value	3-9
3.6 Optimizing SLS Database Files	3-9
3.6.1 Recommended Minimum Optimization	3-10

3.6.2	How to Optimize Files Using FDL	3-10
-------	---------------------------------------	------

4 SLS Catalog Safety and Maintenance

4.1	Volume Database Location	4-2
4.2	SLS History Files	4-2
4.2.1	Creating SLS System History Files for System Backup Operations	4-3
4.2.1.1	Naming Your SLS System History File Sets	4-3
4.2.1.2	Defining SLS System History File Set Directories	4-4
4.2.1.3	Rules for SLS System History File Set Names and Directories	4-4
4.2.1.4	Example: SLS System History File Assignments	4-4
4.2.1.5	Characterizing SLS System History Files	4-4
4.2.2	Defining Characteristics of SLS System History Sets	4-4
4.2.2.1	Determining the Space Required for SLS System History File Sets	4-5
4.2.2.2	History Records for Individual File Versions	4-5
4.2.2.3	Declaring the Maximum File Name Size	4-5
4.2.2.4	Declaring the Maximum Number of SLS System History Pointers Per File	4-6
4.2.2.5	Choosing to Store the Node Name in the Files File	4-7
4.2.3	Transferring Existing Backup Files to SLS History Files	4-8
4.2.3.1	Requirements for Transferring Files	4-8
4.2.3.2	Adding Existing Backup Files to the SLS Catalog	4-8
4.2.4	Creating SLS User History Files For User Backup Operations	4-9
4.2.4.1	Considerations for User History Files	4-9
4.2.4.2	How to Determine the SLS User History File Location	4-9
4.3	Deleting Old SLS History Files	4-10
4.3.1	The CLEANUP Process	4-11
4.3.1.1	Cleaning SLS System History Files	4-11
4.3.1.2	The SYSCLN and CLEANUP Relationship	4-11
4.3.1.3	Controlling the Cleanup Process	4-11
4.3.1.4	Setting the Days and Durations for Cleaning SLS History Files	4-12
4.3.2	SYSCLN Menu	4-12
4.3.2.1	Start SYSCLN Processing	4-14
4.3.2.2	Shutdown SYSCLN Processing	4-15
4.3.2.3	Inquire SYSCLN Status	4-16
4.3.2.4	Abort SYSCLN Processing	4-18
4.3.3	Delete User Histories	4-18
4.4	Data Safety with the VMS Backup Utility	4-20
4.4.1	Volume and Magazine Database Device Failure	4-20
4.4.2	SLS System History File Device Failure	4-21
4.4.3	Manually Updating the SLS System History Files	4-22
4.5	Data Safety with VAX RMS Journaling and the VMS Backup Utility	4-23
4.5.1	Implementing Data Safety with the VMS Backup Utility and VAX RMS Journaling	4-23
4.5.2	VAX RMS Journal Device Failure	4-24
4.6	Data Safety with VAX Volume Shadowing Software	4-24

5 Configuring SLS System Backup Operations

5.1	SLS System Backup Operations	5-1
5.2	System Backup Command Files	5-2
5.2.1	Creating SLS System Backup Command Files	5-3
5.2.2	System Backup Operations Using SYSBAK.TEMPLATE	5-3
5.2.3	Executing System Backup Operations	5-8
5.2.3.1	Running Manual Backup Operations	5-8

5.2.3.2	Running Automatically Scheduled Backup Operations	5-8
5.3	Preparing for System Backup Operations	5-9
5.3.1	How to Define Automatic Scheduling Days	5-9
5.3.1.1	Symbols for Automatic Scheduling	5-9
5.3.1.2	Specifying a Day of the Week	5-9
5.3.1.3	Specifying a Day Offset into a Month	5-10
5.3.1.4	Specifying a Week Offset into a Month	5-11
5.3.1.5	Specifying the Days to Run System Backup Operations	5-11
5.3.1.6	Specifying the Time of Day to Run System Backup Operations	5-13
5.3.1.7	Overriding the Default Queue with the Time Definition	5-13
5.3.1.8	Specifying the Node Executing the DCL SUBMIT Command	5-13
5.3.1.9	Example: Automatic Scheduling Selection	5-14
5.3.1.10	Skipping an Automatically Scheduled System Backup Operation	5-14
5.3.2	Skipping Automatic System Backup Operations on Holidays	5-15
5.3.2.1	HOLIDAYS.DAT Record Format	5-15
5.3.2.2	Example: HOLIDAYS.DAT File	5-15
5.3.3	Preprocessing and Post-Processing Operations	5-15
5.3.3.1	Execution Sequence for Preprocessing and Post-Processing Symbols	5-15
5.3.3.2	Symbols Enabled for Preprocessing and Post-Processing	5-16
5.3.3.3	Executing Another SBK Batch Job After the Backup Operation	5-17
5.4	Defining the SLS System Backup Operation	5-18
5.4.1	The VMS BACKUP Command	5-18
5.4.1.1	Assignments to FILES_n	5-18
5.4.1.2	Assignments to QUALIFIERS and QUALIFIERS_n	5-18
5.4.1.3	Defining the Backup Privilege	5-24
5.4.1.4	Assignments to MNTFLAGS	5-24
5.4.1.5	Assigning Additional Mount Actions	5-24
5.4.1.6	Save Set Name Symbol Descriptions	5-25
5.4.1.7	Generating Save Set Names	5-27
5.4.1.8	Assigning the PROTECTION Symbols	5-27
5.4.2	System Backup Volume Characteristics	5-27
5.4.2.1	Indicating the Type of Media Used for the Backup Operation	5-28
5.4.2.2	Assigning the Volume Pool for the Backup Operation	5-28
5.4.2.3	Assigning Backup Volume Density	5-28
5.4.2.4	Assigning the Backup Volume Size	5-28
5.4.3	System Backup Operator Intervention Policy	5-29
5.4.3.1	Example: Attended System Backup Assignments with Restrictions	5-29
5.4.3.2	Example: Attended System Backup Assignments with Without Restrictions	5-29
5.4.3.3	Example: Unattended System Backup Assignments	5-29
5.4.3.4	Acknowledging Loaded Volumes	5-30
5.4.3.5	Allocating Volumes Prior to Running the System Backup Operation	5-30
5.4.3.6	Enabling SLS Software to Automatically Select Volumes	5-30
5.4.3.7	Allowable Values for AUTOSEL	5-30
5.4.3.8	Recommended Procedure for Handling Volumes	5-31
5.4.3.9	Handling Volume Label Mismatches During the System Backup Operation	5-31
5.4.3.10	Allowable CONTLOADOPT Values	5-32
5.4.4	System Backup Media Resource Allocation	5-32
5.4.4.1	Considerations for More Than One Save Set on One Volume	5-32
5.4.4.2	Assigning Strings to the CONTINUE Symbol	5-32
5.4.5	System Backup Volume Disposition	5-33
5.4.5.1	Specifying Symbols for SLS System History Files	5-33
5.4.5.2	Naming Your SLS System History Set	5-33

5.4.5.3	Naming the SLS System History Processing Queue	5-33
5.4.5.4	Setting the Number of Days for Volume Retention	5-34
5.4.5.5	Setting Volume Off-Site and On-Site Dates	5-34
5.4.5.6	Allowable OFFSITE_DATE and ONSITE_DATE Assignments	5-35
5.4.5.7	Printing Volume Labels	5-35
5.4.5.8	Allowable Assignments to TAPE_LABELS	5-36
5.4.5.9	Assigning a Note to a Volume	5-36
5.4.6	System Backup Device Control	5-36
5.4.6.1	Assigning the Backup Tape Device	5-36
5.4.6.2	Controlling the Number of Drives Used for a System Backup Operation	5-36
5.4.6.3	How SLS Software Implements N_DRIVES During a System Backup Operation	5-37
5.4.7	System Backup Status and Information Reporting	5-37
5.4.7.1	Job Notification	5-38
5.4.7.2	Progress Reporting by Mail	5-38
5.4.7.3	Naming the Backup Log File	5-38
5.4.7.4	Creating a Listing File Name	5-39
5.4.7.5	Controlling Listing File Format	5-39
5.4.7.6	Printing a Listing File	5-39
5.5	Files Created During a System Backup Operation	5-40
5.5.1	Summary Files	5-40
5.5.2	Allowable SUMMARY_FILE Values	5-41
5.5.3	System Backup Log Files	5-41
5.5.4	Temporary History Files	5-42
5.5.5	Maintenance Log Files	5-42

6 Performing Save Operations

6.1	Preparing for Save Operations	6-1
6.1.1	How SLS Performs Save Operations	6-1
6.1.2	Types of Backup Operations	6-2
6.1.3	Controlling Data Saving Operations	6-2
6.1.3.1	Defining the Backup Operation Format	6-2
6.1.3.2	Restrictions Imposed by the ASCII and EBCDIC Formats	6-3
6.1.3.3	Operator Save Screen Option Defaults	6-3
6.1.3.4	Setting the Operator Save Screen Defaults	6-3
6.1.3.5	Setting the Default Volume Selection Method for User Save Operations	6-4
6.1.3.6	Defining the Backup Volume Protection	6-4
6.1.3.7	Defining the Batch Queue Name for SLS Backup Operations	6-5
6.1.3.8	Notification of Completed Backup Operations	6-5
6.1.3.9	Supplying Default Volume Size for the STORAGE SAVE Command	6-5
6.1.3.10	Save Operations with Nonlibrary Volumes	6-5
6.2	Performing Manual System Backups	6-7
6.2.1	Accessing the Manual System Backup Menu Option	6-7
6.2.2	Procedure For Using the Manual System Backup Option	6-7
6.3	Performing User Save Operations	6-18
6.3.1	User Interface	6-18
6.3.2	Save Screen Diagram	6-18
6.3.3	Procedure For Using the Save Screen Option	6-20
6.4	Performing Unattended Backup Operations	6-27
6.4.1	How an Unattended System Backup Operation Works	6-27
6.4.2	Modifying System Backup Procedures	6-28
6.4.3	Performing Unattended System Backups	6-29
6.4.4	Performing Unattended System Backups Using Preallocated	6-30

7 Restoring Files and Disks

7.1 Restoring Data	7-1
7.1.1 Defining the Restore Operation Queue	7-1
7.1.2 Setting Operator Restore Screen Option Defaults	7-1
7.1.3 Notification when Restore Is Finished	7-2
7.1.4 Controlling Data Restore Operations	7-2
7.1.5 Restore Operations with Nonlibrary Volumes	7-2
7.2 Restoring a Disk	7-3
7.3 Restoring a File or Group of Files	7-6
7.3.1 Requesting a Restore Operation	7-6
7.3.2 Using the Restore Screen	7-6

8 Using RMU Backup and Restore with SLS

8.1 Overview of RMU Backup and Restore Support	8-1
8.2 Using RMU and SLS Together	8-1
8.2.1 Oracle Rdb Minimum Version	8-2
8.2.2 Types of System Backup Operations	8-2
8.3 Overview of Database System Backup Processing	8-2
8.4 Defining Database System Backup Operations	8-2
8.4.1 Identifying Database Backup History Sets in TAPESTART.COM	8-3
8.4.2 Locating the Database System Backup Command File	8-4
8.4.3 Identifying Backup Operation Type	8-4
8.4.4 Modifying Existing Symbols	8-5
8.4.5 Using QUALIFIERS_n	8-6
8.4.6 Nullifying Existing Symbols	8-6
8.4.7 Compaction issue with RMU Backup on VMS 7.2-1 and 7.3	8-6
8.4.8 Specifying Oracle Rdb Software Version	8-7
8.5 Running Database System Backups	8-7
8.5.1 Running Database Backups Automatically	8-7
8.5.2 Running Database Backups Manually	8-7
8.5.2.1 Using the DCL Command Interface	8-7
8.5.2.2 Using the Operator Menu Interface	8-7
8.6 Using Volume Reports to Identify Database Backups	8-8
8.7 Restoring a Database	8-8
8.7.1 Before Restoring an Oracle Rdb Database	8-9
8.7.1.1 Designating an Oracle RMU Restore Operation	8-9
8.7.1.2 Specifying Oracle Rdb Software Version	8-9
8.7.1.3 Specifying RMU/RESTORE Qualifiers	8-10
8.7.1.4 Using an Options File	8-10
8.7.2 Example Oracle RMU Restore Scenarios	8-10
8.7.2.1 Full Restore of a Single File Database	8-10
8.7.2.2 Full Restore of Multiple File Database	8-11
8.7.2.3 Full Restore of an Area of a Multiple File Database	8-12

9 Performing SLS Archiving Operations

9.1 Automatic Archiving	9-1
9.1.1 Preparing for Automatic Archiving	9-1
9.1.2 Setting File Retention and Expiration Times	9-1
9.1.2.1 How the File Retention Time Works	9-2
9.1.2.2 A Graphic Look at File Retention Times	9-2

9.1.2.3	Special Cases of File Access	9-2
9.1.2.4	Rules for Applying the File Retention Time with the SET VOLUME Command	9-3
9.1.2.5	How to Set the File Retention Time	9-3
9.1.2.6	How to Set Expiration Times for Files	9-4
9.1.2.7	How to Determine a File's Expiration Date	9-4
9.1.3	Controlling Automatic Archiving	9-4
9.2	Standby Archiving	9-6
9.2.1	Advantages of Standby Archiving	9-7
9.2.2	How Standby Archiving Works	9-7
9.2.3	How Standby Archiving Executes Save Requests	9-8
9.2.4	How Standby Archiving Uses .ARKIVE Files	9-8
9.2.5	Editing TAPESTART.COM for Standby Archiving	9-8
9.2.5.1	Defining Standby Archiving Log File Location	9-8
9.2.5.2	Setting the Standby Archiving Interval	9-8
9.2.5.3	Defining the Default Archive Class	9-9
9.2.5.4	Alternate Methods for Defining the Default Archive Class	9-9
9.2.6	Standby Archive Operator Menu Option	9-9
9.2.6.1	Standby Archive Menu Options	9-10
9.2.6.2	Starting Up and Shutting Down the Standby Archiving Process	9-11
9.2.6.3	Before You Begin	9-11
9.2.6.4	Starting Up Standby Archive From the Operator Menu	9-12
9.2.6.5	Shutting Down Standby Archive From the Operator Menu	9-14
9.2.6.6	Inquire Pending Jobs From the Operator Menu	9-15
9.2.6.7	Aborting Standby Archive	9-16
9.2.6.8	How to Interrupt the Standby Archive Process	9-17
9.2.7	Establishing Archive Classes and Enabling User Access	9-17
9.2.7.1	Archive Class Naming Conventions	9-17
9.2.7.2	Authorizing Class Access For a User From The Operator Menu	9-18
9.2.8	Performing Save Operations Using Standby Archiving	9-21
9.2.8.1	Standby Archiving Performed From the User Menu Save Screen	9-21
9.2.8.2	Standby Archiving Performed Using DCL	9-21

10 Generating SLS Reports

10.1	Operator Menu: Inquire Pending Jobs	10-1
10.2	User Menu: Report of Files on User Backups	10-2
10.3	User Menu: Report of Files on System Backups	10-2

A System Backup Command File QuickReference

A.1	Symbols for System Backup Control	A-1
A.2	Symbols for System Backup Type	A-2
A.3	Symbols for System Backup Volume Characteristics	A-3
A.4	Symbols for System Backup Operator Intervention	A-4
A.5	Symbols for System Backup Resource Allocation	A-5
A.6	Symbols for System Backup Volume Disposition	A-5
A.7	Symbols for System Backup Device Control	A-6
A.8	Symbols for System Backup Status and Information	A-7

B Remote Backup Worksheet

11 Introduction to Media and Device

Management Services

11.1 What MDMS Provides	11-1
11.2 Where MDMS Stores Information	11-2
11.3 MDMS User Interfaces	11-2
11.4 Who Interacts with MDMS	11-2

12 Configuring for Media Management

12.1 Understanding TAPESTART.COM Symbols and Definitions	12-1
12.1.1 Basic MDMS Symbols	12-1
12.1.2 Media Triplets	12-3
12.1.2.1 Guidelines for Media Triplet Assignments	12-4
12.1.2.2 Default Media Triplet	12-4
12.1.2.3 Creating Default Media Triplets	12-5
12.1.2.4 Inserting Media Triplets Into TAPESTART.COM	12-6
12.1.2.5 Media Triplets for Tape Jukebox Devices	12-7
12.1.3 Volume Management Symbols	12-7
12.1.3.1 Volume Management Privileges Symbols	12-9
12.1.3.2 Volume Loading Symbol	12-10
12.1.4 Operator Terminal Control Symbols	12-10
12.1.5 Drive Control Symbols	12-12
12.1.6 Miscellaneous Symbol Assignments	12-12

13 Managing Jukebox Devices Using MDMS

13.1 Working with Magnetic Tape Jukeboxes	13-1
13.1.1 Customizing TAPESTART.COM for Robotically Controlled Magnetic Tape Jukebox Devices	13-2
13.1.1.1 Required Naming Conventions	13-2
13.1.1.2 Required Media Triplets	13-3
13.1.2 Determining Your Hardware Configuration	13-3
13.1.3 Direct Connect DSSI Devices	13-4
13.1.3.1 Customizing TAPESTART.COM for Direct DSSI Devices	13-4
13.1.4 Direct Connect SCSI Devices	13-5
13.1.4.1 Creating a Tape Robot Unit	13-5
13.1.4.2 Customizing TAPESTART.COM Symbols for a Direct Connect SCSI Device	13-6
13.1.5 Controller-Connected SCSI Devices	13-6
13.1.5.1 Using SCSI Tape Jukeboxes Connected to an HSC Controller	13-7
13.1.5.2 Using A SCSI Tape Jukeboxes Connected to an HSD or HSJ Controller	13-7
13.1.5.3 Customizing TAPESTART.COM Symbols for a Controller-Connected SCSI Device	13-9
13.1.5.4 TL810- and TL820-Type Devices with Multiple Drives	13-9
13.1.6 Defining Multiple Tape Jukebox Symbols and Associated Media Triplets	13-10
13.1.7 Using a Cleaning Cartridge in a Managed Jukebox	13-11
13.2 Using TMSCP-Served Tape Devices	13-12
13.3 Using Magazines with Tape Jukeboxes in MDMS	13-12
13.3.1 Adding a Magazine	13-13
13.3.2 Manually Binding Volumes to a Magazine	13-14
13.3.3 Automatically Binding Volumes to a Magazine	13-16
13.3.4 Using Multiple Magazines in Single and Multitower Jukeboxes.	13-17
13.3.4.1 Bin Numbering Convention	13-17
13.3.4.2 How to Calculate the Slot Numbers When Using Multiple Magazines	13-17
13.3.5 Loading and Unloading Volumes in a Jukebox	13-18
13.3.6 Physically Removing a Magazine from a Jukebox	13-18

13.3.7	Removing Magazines from Use	13-18
13.3.8	Removing a Magazine from the MDMS Magazine Database	13-19
13.3.9	Showing Magazine Information	13-19
13.3.10	Showing Volumes in a Magazine	13-20
13.3.11	Using Magnetic Tape Jukeboxes with Individual Cartridges	13-20
13.3.11.1	Importing a Cartridge Into a TL810 Jukebox	13-21
13.4	Operating Tape Jukeboxes as Stack Loaders	13-22
13.5	Resolving Jukebox Problems	13-22
13.5.1	Separating Software and Hardware Tape Movement Requests	13-22
13.5.2	Identifying Unrecoverable Robotic Control Errors	13-23
13.6	Using a TL800 Class Jukebox	13-23
13.6.1	TL800 Jukebox Features and What They Mean	13-23
13.6.2	Recommended Hardware Settings	13-23
13.6.3	Using Uncataloged Media with a TL800 Class Jukebox	13-24
13.6.4	Using Cataloged Media with a TL800 Class Jukebox	13-25
13.7	Working with DCSC-Controlled Robotic Silos	13-26
13.7.1	Customizing TAPESTART.COM for DCSC-Controlled Silos	13-27
13.7.1.1	DCSC_DRIVES Symbol	13-27
13.7.1.2	Media Triplet for DCSC Tape Devices	13-27
13.7.1.3	DCSC_n_NODE Symbol	13-28
13.7.2	MDMS Functions Associated with DCSC-Controlled Silos	13-28
13.7.2.1	STORAGE Commands for Silos	13-28
13.7.3	Identifying the Volumes in a DCSC-Controlled Silo	13-28
13.7.4	13.7.4 Adding Volumes to a DCSC-Controlled Silo	13-28
13.7.5	Removing Volumes from a DCSC-Controlled Silo	13-28
13.7.6	ACS Management Menu	13-29
13.7.6.1	ACS Management Menu: Inventory Volume Series	13-29
13.7.6.2	Inventory Volume Series Screen Diagram	13-29
13.7.6.3	How To Use The Inventory Volumes Series Option	13-30
13.7.6.4	ACS Management Menu: Import Volume(s)	13-31
13.7.6.5	Import Volume(s) Screen Diagram	13-31
13.7.6.6	How To Use The Import Volume Option	13-32
13.7.6.7	ACS Management Menu: Initialize Volume Series	13-34
13.7.6.8	13.7.6.8 Initialize Volume Series Screen Diagram	13-34
13.7.6.9	How To Use The Initialize Volume Series Option	13-34
13.7.6.10	ACS Management Menu: Load Volume Onto Drive	13-37
13.7.6.11	Load Volume Onto Drive Screen Diagram	13-37
13.7.6.12	How To Use The Load Volume Onto Drive Option	13-37
13.7.6.13	ACS Management Menu: Unload Drive	13-38
13.7.6.14	Unload Drive Screen Diagram	13-38
13.7.6.15	How To Use The Unload Drive Option	13-39
13.7.6.16	ACS Management Menu: Unload Volume	13-40
13.7.6.17	Unload Volume Screen Diagram	13-40
13.7.6.18	How To Use The Unload Volume Option	13-40
13.7.6.19	ACS Management Menu: Export Volume(s)	13-41
13.7.6.20	Export Volume(s) Screen Diagram	13-41
13.7.6.21	How To Use The Export Volume(s) Option	13-41

14 Connecting and Managing Remote Devices

14.1	The RDF Installation	14-1
14.2	Configuring RDF	14-1
14.2.1	Configuration Scenarios	14-4

14.2.1.1	Scenario 1-Single Remote Device	14-4
14.2.1.2	Scenario 2-Local Area Network	14-6
14.2.1.3	Scenario 3-Two-Way Remote Backup Operations	14-8
14.2.1.4	Scenario 4-Multiple Remote Nodes	14-11
14.3	Using RDF with MDMS	14-14
14.3.1	Restrictions: Using RDF with MDMS Software	14-14
14.3.2	Assignments to ALLDEV and SELDEV Symbols for Remote Operations	14-15
14.3.3	Starting Up and Shutting Down RDF Software	14-15
14.3.4	The RDSHOW Procedure	14-16
14.3.5	Command Overview	14-16
14.3.6	Showing Your Allocated Remote Devices	14-16
14.3.7	Showing Available Remote Devices on the Server Node	14-16
14.3.8	Showing All Remote Devices Allocated on the RDF Client Node	14-17
14.4	Monitoring and Tuning Network Performance	14-17
14.4.1	DECnet Phase IV	14-17
14.4.2	DECnet-Plus	14-18
14.4.3	Changing Network Parameters	14-18
14.4.3.1	Changing Network Parameters for DECnet Phase IV	14-18
14.4.3.2	Changing Network Parameters for DECnet-Plus	14-19
14.4.4	Resource Considerations	14-20
14.4.5	Controlling RDF's Effect on the Network	14-22
14.4.6	Surviving Network Failures	14-22
14.5	Controlling Access to RDF Resources	14-23
14.5.1	Allow Specific RDF Clients Access to All Remote Devices	14-23
14.5.2	Allow Specific RDF Clients Access to a Specific Remote Device	14-24
14.5.3	Deny Specific RDF Clients Access to All Remote Devices	14-24
14.5.4	Deny Specific RDF Clients Access to a Specific Remote Device	14-24
14.6	RDserver Inactivity Timer	14-25
14.7	RDF Error Messages	14-25

15 Managing Volumes With MDMS

15.1	Definition of Terms	15-1
15.2	Single-Sided and Double-Sided Media	15-3
15.3	The RV02K Optical Cartridge	15-3
15.4	Volume States	15-3
15.4.1	Determining the State of a Volume	15-5
15.4.1.1	Determining the State of Deallocated Volumes	15-5
15.4.1.2	Defining the Transition Time of Volumes	15-6
15.4.2	Changing a Volume State	15-6
15.5	Adding Volumes to the MDMS Volume Database	15-7
15.5.1	Adding Volumes from DCL	15-7
15.5.2	Adding Volumes from Menus	15-7
15.5.3	Adding Double-Sided Volumes	15-8
15.6	Initializing Volumes	15-8
15.7	Managing Volumes With MDMS	15-8
15.7.1	Assigning the Volume Default Location	15-8
15.7.2	Making Volumes Available	15-9
15.7.2.1	Defining the Default Volume Scratch Time for Allocation	15-9
15.7.2.2	Defining the Maximum User-Set Scratch Date	15-9
15.7.2.3	Notifying Users of Scratch Date	15-10
15.7.2.4	Enabling User Notification of Volume Scratch Date	15-10
15.7.2.5	Notifying Other Users When a Volume Reaches Its Scratch Date	15-10

15.7.3	Reporting on Volume Usage	15-10
15.7.3.1	The Volume Usage Report	15-11
15.7.3.2	Volume Accounting Period	15-11
15.7.3.3	Customizing Your Volume Usage Report	15-11
15.7.3.4	Producing a Volume Usage Report on Demand	15-12
15.8	Printing Labels	15-13
15.8.1	Label Template Files	15-13
15.9	When to Remove Volumes from the Database	15-13

16 Authorizing Access to MDMS Media

16.1	Managing Volume Privileges	16-1
16.1.1	Default MDMS Privilege Assignments	16-1
16.1.2	Privileges Required to Modify Volume Database Fields	16-3
16.2	Enabling Access to the MDMS Volume Database	16-3
16.2.1	MDMS Volume Database Access Authorization Screen	16-4
16.2.2	Database Access Authorization Screen Fields	16-4
16.2.3	How to Authorize MDMS Client Node Access to the MDMS Volume Database	16-4
16.2.4	How to Find a Node Name in the Database Access Authorization screen	16-5
16.2.5	How to Edit a Node Name in the Database Access Authorization Screen	16-6
16.2.6	How to Delete a Node Name in the Database Access Authorization Screen	16-6
16.3	Authorizing Access to Volume Pools	16-7
16.3.1	MDMS Volume Pool Authorization Screen	16-7
16.3.2	16.3.2 Volume Pool Authorization Screen Fields	16-8
16.3.3	How to Authorize Access to Volume Pools	16-8
16.3.4	How to Find a User Entry in the Volume Pool Authorization Screen	16-9
16.3.5	How to Edit a User Entry in the Volume Pool Authorization Screen	16-10
16.3.6	How to Delete a User Entry in the Volume Pool Authorization Screen	16-10

17 Managing Vault Storage Using MDMS

17.1	Vault Management Concepts	17-1
17.2	Scheduling Vault Transfers with MDMS Software	17-2
17.2.1	Scheduling Vault Dates	17-2
17.2.1.1	Explicit Schedule	17-2
17.2.1.2	Daily or Weekly Schedule	17-3
17.3	Updating A Volume's On-Site or Off-Site Location	17-5
17.3.1	Changing Volume Locations Using RACK and VAULT	17-5
17.3.2	Changing Volume Locations Using the Vault Management Menu	17-6
17.3.3	Vault Management Menu Screen	17-6
17.3.4	Vault Management Menu Options	17-6
17.3.4.1	Vault Management Menu: Change to On-site	17-7
17.3.4.2	Vault Management Menu: Change to Off-site	17-7
17.3.4.3	Vault Management Menu: Mass Movement	17-8
17.3.4.4	Vault Management Menu: Change On-site Date	17-8
17.3.4.5	Vault Management Menu: Change Off-site Date	17-9
17.3.4.6	Vault Management Menu: Change Name for Current Process	17-9
17.4	Generating Reports	17-9

C TAPESTART.COM Quick Reference

C.1	TAPESTART.COM Symbols for Configuration	C-1
C.2	TAPESTART.COM Symbols for Standby Archiving	C-3

C.3 TAPESTART.COM Symbols for Restore Operations C-4

Tables

Table 2–1 Operator Menu Options	2-3
Table 2–2 User Menu Options	2-5
Table 3–1 Establishing the Active Server Node	3-3
Table 3–2 Establishing a Client Connection on an OpenVMS Cluster	3-4
Table 3–3 How to Optimize a SLS Data File	3-11
Table 4–1 Values for SEPARATE_VERSION	4-5
Table 4–2 How to Change Pointer Values	4-7
Table 4–3 Values for NULL_NODE	4-8
Table 4–4 Transferring Existing Backup Files if no Listing Available	4-8
Table 4–5 Values for SLS\$USRBAK Logical	4-10
Table 4–6 Accessing the SYSCLN Menu	4-13
Table 4–7 SYSCLN Menu Options Descriptions	4-13
Table 4–8 Start SYSCLN Processing	4-15
Table 4–9 Shutdown SYSCLN Processing	4-16
Table 4–10 Inquire SYSCLN status	4-16
Table 4–11 Abort SYSCLN Process	4-18
Table 4–12 Delete User Histories	4-19
Table 4–13 How to Restore the Volume or Magazine Database from a BACKUP Copy	4-20
Table 4–14 How to Restore the SLS System History Files from a BACKUP Copy	4-21
Table 4–15 How to Manually Update SLS System History Files	4-22
Table 4–16 How to Implement a Data Safety Policy Using the VMS Backup Utility with VAX RMS Journaling	4-23
Table 4–17 How to Respond to a VAX RMS Journal Device Failure	4-24
Table 5–1 How to specify the days to run system backup operations	5-12
Table 5–2 Execution Sequence for Pre- and Post-Processing Symbols	5-16
Table 5–3 Symbols Enabled for Pre- and Post-Processing	5-17
Table 5–4 When to use QUALIFIERS or QUALIFIERS_n	5-20
Table 5–5 When to use OUTPUT_QUAL or OUTPUT_QUAL_n	5-21
Table 5–6 Recommended QUALIFIERS or QUALIFIERS_n Assignments	5-22
Table 5–7 Mount Action Symbol Assignments	5-25
Table 5–8 Values for SAVESET_GEN	5-26
Table 5–9 How to Generate Save Set Names	5-27
Table 5–10 Values for AUTOSEL	5-31
Table 5–11 How to Handle System Backup Volumes	5-31
Table 5–12 Values for CONTLOADOPT	5-32
Table 5–13 Values for OFFSITE DATE and ONSITE DATE	5-35
Table 5–14 Values for TAPE LABELS	5-36
Table 5–15 Values for DRIVE TYPE	5-36
Table 5–16 SLS Implementation of N_DRIVES Symbol	5-37
Table 5–17 Values for PROGRESS Symbol	5-38
Table 5–18 Values for SUMMARY FILE	5-41
Table 6–1 Setting Save Screen Defaults using BAKOPT	6-3
Table 6–2 Values for BACKUP_DEFAULT_REEL	6-4
Table 6–3 How to define the Hexadecimal Protection Code	6-4
Table 6–4 Manual System Backup Procedure	6-8
Table 6–5 Keys Defined for User Save Operations	6-18
Table 6–6 Save Screen	6-20
Table 6–7 How Unattended Backup Operations Work	6-27
Table 6–8 Performing an Unattended System Backup Operation	6-29
Table 6–9 Unattended System Backups Using Preallocated VolumeSets	6-30
Table 7–1 Values for RESOPT	7-2
Table 7–2 Full Disk Restore	7-3

Table 7-3	Ways to Restore a File or Group of Files	7-6
Table 7-4	Defined Keys for Restore Screen	7-7
Table 7-5	Restore Screen	7-7
Table 8-1	Process for Defining Database System Backup Operations	8-3
Table 8-2	Symbols with New Meanings	8-5
Table 8-3	Process for Restoring a Database	8-9
Table 9-1	Preparing for Automatic Archiving	9-1
Table 9-2	Automatic Archiving Symbols in ARCHIVE_SBK.COM	9-4
Table 9-3	The Standby Archiving Process	9-7
Table 9-4	How to Access the Standby Archive Menu	9-10
Table 9-5	Options for Standby Archive Menu	9-11
Table 9-6	Start Up Standby Archive	9-12
Table 9-7	Shutdown Standby Archive	9-15
Table 9-8	Inquire Pending Jobs	9-16
Table 9-9	Abort Standby Archive	9-17
Table 9-10	How to Authorize Class Access for a User	9-19
Table 9-11	Creating a User Save Request For Standby Archiving	9-21
Table 10-1	Inquire Pending Jobs	10-1
Table 10-2	Report of Files on User Backups	10-2
Table 10-3	Report of Files on System Backups	10-3
Table 11-1	MDMS Databases and Their Contents	11-2
Table 12-1	Creating Default Media Triplets	12-6
Table 12-2	Inserting Media Triplets into TAPESTART.COM	12-6
Table 13-1	Determining Your Hardware Configuration	13-4
Table 13-2	Creating A Tape Robot Unit	13-5
Table 13-3	Using a SCSI Loader on an HSC Controller	13-7
Table 13-4	Using a SCSI Loader on an HSD or HSJ Controller	13-7
Table 13-5	Using a TL810/820 SCSI Device Connected to an HSD or HSJ	13-8
Table 13-6	Process for Using Magazines with Tape Jukeboxes	13-13
Table 13-7	How to Manually Bind Volumes to a Magazine	13-14
Table 13-8	Calculating Slot Numbers	13-17
Table 13-9	Using Uncataloged Media with a TL800 Class Jukebox	13-24
Table 13-10	Using Cataloged Media with a TL800 Class Jukebox	13-25
Table 13-11	Inventorying Volume Series	13-30
Table 13-12	Importing Volumes	13-32
Table 13-13	Initializing Volume Series	13-34
Table 13-14	Loading Volumes Onto a Drive	13-37
Table 13-15	Unloading Drives	13-39
Table 13-16	Unloading Volumes	13-40
Table 13-17	Exporting Volumes	13-41
Table 14-1	How to Change Network Parameters	14-19
Table 15-1	Volume States	15-4
Table 15-2	Allowable Assignments for the FRESTA Symbol	15-5
Table 15-3	How to Change the Volume State	15-6
Table 15-4	Customizing Your Volume Usage Report	15-11
Table 16-1	Volume Management Privileges	16-2
Table 16-2	How to Authorize Client Node Access to the MDMS Volume Database	16-5
Table 16-3	How to Find a Node Name in the Database Access Authorization Screen	16-5
Table 16-4	How to Edit a Node Entry in the Database Access Authorization Screen	16-6
Table 16-5	How to Delete a Node Name Entry in the Database Access Authorization Screen	16-7
Table 16-6	How to Enable User Access to Volume Pools	16-8
Table 16-7	How to Find a User Entry in the Volume Pool Authorization Screen	16-9

Table 16–8How to Edit a User Entry in the Volume Pool Authorization Screen	16-10
Table 16–9How to Delete a User Entry in the Volume Pool Authorization Screen	16-11
Table 17–1How to Establish a Daily or Weekly Vault Schedule	17-3
Table 17–2Vault Management Menu Options	17-7

Figures

Figure 2-1	SLS Administrator Menu	2-2
Figure 2-2	Operator Menu	2-3
Figure 2-3	User Menu	2-5
Figure 3-1	SLS Server and Client Processes	3-2
Figure 3-2	Two-Node SLS Client-Server Process	3-5
Figure 3-3	Three-Node SLS Client-Server Process	3-6
Figure 3-4	Five-Node SLS Client-Server Process	3-8
Figure 4-1	SYSCLN Menu	4-13
Figure 4-2	Start SYSCLN Processing Screen.	4-14
Figure 4-3	Shutdown SYSCLN Processing screen.	4-15
Figure 4-4	Delete User Histories Screen Diagram	4-19
Figure 6-1	Manual System Backup.	6-7
Figure 6-2	Save Screen	6-19
Figure 7-1	Full Disk Restore Screen.	7-3
Figure 7-2	Restore Screen.	7-7
Figure 9-1	File Retention Times	9-2
Figure 9-2	illustrates the Standby Archive Menu.	9-10
Figure 9-3	Standby Archive Menu.	9-12
Figure 9-4	Shutdown Standby Archive.	9-15
Figure 9-5	Inquire Pending Jobs	9-16
Figure 9-6	B1C.TEMPLATE	9-19
Figure 13-1	Determining a Magnetic Tape Jukebox Hardware Configuration	13-3
Figure 13-2	ACS Management Menu	13-29
Figure 13-3	Inventory Volume Series.	13-30
Figure 13-4	Import Volumes(s) Screen	13-32
Figure 13-5	Initialize Volume Series Screen	13-34
Figure 13-6	Load Volume Onto Drive Screen	13-37
Figure 13-7	Unload Drive Screen	13-39
Figure 13-8	Unload Volume(s) Screen	13-40
Figure 13-9	Export Volume Screen	13-41
Figure 14-1	How RDF and MDMS Software Communicate	14-3
Figure 14-2	Single Remote Device.	14-5
Figure 14-3	Local Area Network	14-7
Figure 14-4	Two-Way Remote Backup Operation.	14-9
Figure 14-5	Backup Operation Among Multiple Remote Nodes	14-12
Figure 15-1	Volume State Cycling	15-4
Figure 16-1	Database Access Authorization.	16-4
Figure 16-2	Volume Pool Authorization	16-8
Figure 17-1	Vault Management Menu	17-6

Purpose of This Document

This document contains information about Storage Library System for OpenVMS™ Version 2.9H software and its backup, archive, and restore functions. Use this document to define, configure, operate, and maintain your SLS environment.

Once SLS is installed on your system, the online release notes are available in:

`SYS$HELP:SLSH029.RELEASE_NOTES`

Intended Audience

This manual is intended for users of SLS software, including storage administrators, operators, and users.

Document Structure

This document is organized in the following manner and includes the following information:

- Chapter 1 Introduces storage management and the key concepts of SLS.
- Chapter 2 Introduces the SLS menu interface.
- Chapter 3 Explains how to maintain the safety of SLS data.
- Chapter 4 Describes how to configure SLS software for system backup operations.
- Chapter 5 Explains how to save copies of data using SLS.
- Chapter 6 Explains how to restore individual data files and disks using SLS.
- Chapter 7 Describes how to save and restore Oracle Rdb databases through SLS.
- Chapter 8 Explains how to use SLS to archive data.
- Chapter 9 Describes how to generate SLS reports.
- Chapter 10 Describes the command interface for SLS. This chapter serves as the SLS command reference guide for backup and restore commands. For information about media and device management commands, see the *Media and Device Management Services for OpenVMS Guide to Operations*.

Appendix A Provides a list of TAPESTART.COM symbols.

Appendix B Lists system backup command file (*.SBK) symbols.

Appendix C Provides a worksheet for configuring and performing backups to and from remote devices.

Related Documents

The following documents are related to this documentation set or are mentioned in this manual:

- *Media and Device Management Services for OpenVMS Guide to Operations*
- *OpenVMS System Management Utilities Reference Manual: A--L*
- *OpenVMS DCL Dictionary: A--M*
- *OpenVMS DCL Dictionary: N--Z*
- *OpenVMS License Management Utility Manual*
- *OpenVMS User's Manual*
- *Storage Library System for OpenVMS Installation Guide*

Conventions

The following conventions are used in this document:

Convention	Description
{ }	In format command descriptions, braces indicate required elements. You must include one of the elements.
[]	Square brackets show optional elements in command syntax. You can omit these elements if you wish to use the default response.
...	Horizontal ellipsis points indicate the omission of information from a sentence or paragraph that is not important to the topic being discussed.
.	Vertical ellipsis points indicate the omission of information from an example or command format. The information has been omitted because it is not important to the topic being discussed.
boldface type	Boldface type in text indicates the first instance of a term defined in the Glossary or defined in text.
<i>italic type</i>	Italic type emphasizes important information, indicates variables, indicates complete titles of manuals, and indicates parameters for system information.
Starting test ...	This type font denotes system response, user input, and examples.
Ctrl/x	Hold down the key labeled Ctrl (Control) and the specified key simultaneously (such as Ctrl/Z).

Convention	Description
PF1 <i>x</i>	The key sequence PF1 <i>x</i> instructs you to press and release the PF1 key, and then press and release another key (indicated here by <i>x</i>).
<i>n</i>	A lowercase <i>n</i> denotes the generic use of a number. For example, 19 <i>nn</i> indicates a four-digit number in which the last two digits are unknown.
<i>x</i>	A lowercase <i>x</i> denotes the generic use of a letter. For example, <i>xxx</i> indicates any combination of three alphabetic characters.

Related Products

The following related products are mentioned in this document:

Product	Description
ABS	ABS refers to Archive Backup System for OpenVMS™, Version 2.2 software.
HSM	HSM refers to Hierarchical Storage Management for OpenVMS, Version 2.2 software.
MDMS	MDMS refers to Media, Device and Management Services for OpenVMS, Version 2.9H software.
SMF	SMF refers to Sequential Media Filesystem for OpenVMS, Version 1.3 software.
SLS	SLS refers to Storage Library System for OpenVMS, Version 2.9H software.

Determining and Reporting Problems

If you encounter a problem while using SLS, report it to HP through your usual support channels.

Review the Software Product Description (SPD) and Warranty Addendum for an explanation of warranty. If you encounter a problem during the warranty period, report the problem as indicated above or follow alternate instructions provided by HP for reporting SPD nonconformance problems.

Part I

SLS Application Guide

This part contains information about SMF operations including system backups, standby archiving, and restoring data.

Introduction to Storage Library System for OpenVMS

1.1 SLS Storage Management Concepts

Because your data represents a substantial investment, it is important to safeguard it. The tasks of storage management are concerned with managing storage resources for data maintenance.

The following sections describe the fundamental concepts and principles of storage management and how SLS software can help you implement them.

1.1.1 Why You Save Data

SLS software manages the movement of data from online data storage to nearline and offline data storage.

Primary reasons:

There are two primary reasons for saving data:

1. Data safety
2. Business or statutory reasons

Secondary reason:

A secondary reason for saving data is to manage online storage space. To meet cost and resource needs, data saved to nearline or offline storage can be deleted to make more storage space available.

1.1.1.1 Backup Copy of Data

The purpose of a **backup** copy is to be able to recover data after unexpected loss, including:

- Equipment failure
- Human error
- Site catastrophe

Your data safety policy must accommodate disaster recovery. It is important to quickly retrieve damaged or missing information to minimize your organization's down time.

Frequency of backup:

Backup copies typically occur in cycles. They are created periodically and lose importance after some number of periods have passed.

Example:

An organization might make backup copies of user data every week and discard a saved copy when it becomes five weeks old.

Introduction to Storage Library System for OpenVMS

1.2 Storage Management Responsibilities

1.1.1.2 Archive Copy of Data

The purpose of an **archive** copy is business oriented. An archive copy is made to preserve data to satisfy business requirements.

Frequency of archive:

Archive copies are typically created at the close of a business-related event or process. After the archive copy is made, the original information may be deleted or retained for read-only access. Archive copies are typically kept forever, unless they are explicitly deleted by the storage administrator.

Because archive copies are not frequently accessed, nearline or offline storage is suitable for archived data.

Examples:

- An organization might make archive copies of its yearly payroll account and retain them for 15 years to satisfy a government requirement.
- An organization might make archive copies of inactive project data to make more online storage space available.
- A business may make an archive copy of software at each stage of development. The archive copy is then removed to an off-site storage vault.

1.1.1.3 Defining Data Safety Policy

The storage administrator decides which data to move from online to nearline and offline storage. This decision needs to maximize resource efficiency without sacrificing the ability to restore lost data.

To define the data safety policy, consider the following:

- Which data has to be copied
- The purpose for copying the data
- How often and at what time the data is to be copied
- The class of storage best suited for the data
- The likelihood of its need
- Operational staff support

1.1.1.4 Policy Implementation and Administration

SLS software allows you to implement decisions about saving and restoring data. The storage administrator is responsible for reviewing and responding to the needs for saving and restoring data as they change.

Ongoing policy administration includes responding to changes in:

- The data to be saved
- Computing available storage resources for the movement of data to nearline or offline storage
- The personnel assigned to the media management tasks

1.2 Storage Management Responsibilities

There are three kinds of computer users that work with SLS:

- Storage administrators-responsible for designing and implementing storage management policies
- Operators-responsible for controlling media and devices to save and restore data
- Users-responsible for managing their own data, which includes requesting information be saved and restored

In any given operating environment, these kinds of users may not be distinguishable. However, SLS provides menus and presumes particular responsibilities are appropriate for each. This section describes the responsibilities and SLS tasks for each of these users.

1.2.1 Storage Administrator's Responsibilities

The storage administrator's responsibilities include formulating and implementing an organization's storage management policy.

The storage administrator's responsibilities include:

- Defining the data safety (backup and archiving) policy
- Implementing and administering the policy
- Installing SLS software
- Configuring the SLS software

Storage Administrator's Tasks

The storage administrator's tasks include:

- Installing the SLS software
- Configuring the SLS software
- Authorizing access to SLS features
- Managing the use of media for backup and archive operations
- Managing the accessibility and use of volumes
- Managing the creation of backup copies
- Managing the creation of archive copies
- Managing data restore operations

1.2.2 Operator's Responsibilities

The operator is primarily concerned with implementing the storage management policy defined by the storage administrator.

The operator's responsibilities include:

- Following storage management policy to ensure the preservation of critical data
- Managing media and devices needed by the SLS software to properly preserve data
- Assisting SLS software users with save, archive and restore requests

Operator's Tasks

The operator's tasks include:

- Initiating and responding to system and user save and restore operations
- Initiating archiving operations
- Restoring saved and/or archived copies of data

Introduction to Storage Library System for OpenVMS

1.2 Storage Management Responsibilities

- Managing the volume database
- Managing the magazine database
- Managing a volume's life cycle within the volume database
- Managing media
- Managing drives
- Implementing on-site/off-site volume transfers

1.2.3 User's Responsibilities

The user's responsibilities include:

- Managing their files, volumes and volume sets
- Managing the selection and personal use of drives for their data storage
- Performing save and restore operations of their data
- Maintaining their part of the site-specific SLS software policy that the storage administrator implemented (See your storage administrator for your site's policy.)

User's Tasks

The user's tasks include:

- Choosing volumes
- Arranging volumes and volume sets
- Displaying information
- Modifying volume attributes
- Generating labels
- Requesting reports
- Choosing drives
- Submitting user requests for save and restore operations

Using SLS Menu Interfaces

SLS provides two ways for you to manage save and restore operations:

- DCL STORAGE commands
- SLS menu interface

This chapter introduces the menu interfaces for managing save and restore operations. These menus also provide MDMS media and device management capabilities. Detailed information about how to perform specific menu-driven tasks are provided in later sections of this book and in the *Media and Device Management Services for OpenVMS Guide to Operations*.

For more information about the DCL STORAGE commands, see *Storage Library System for OpenVMS Command Reference Guide* and the DCL STORAGE commands chapter in the *Media and Device Management Services for OpenVMS Guide to Operations*.

2.1 SLS Menus

SLS provides three menus by which you can control the operation of the software:

- **Administrator Menu**-Allows you to control volume pools and database authorization.
- **Operator Menu**-Allows you to add and remove volumes, initiate backup and restore operations, and perform other volume maintenance tasks.
- **User Menu**-Allows you to view information about volumes and perform user-controlled backup operations.

Note

To make the SLS menus accessible, execute the following command file:
@SYS\$MANAGER:SLS\$TAPSYMBOL.COM

2.2 Administrator Menu

The Administrator Menu accesses the functions that control the following two functions:

3. Client node access to the volume database
4. User access to volume pools

These are the only two functions available from this menu. There are no equivalent DCL STORAGE commands.

2.2.1 Accessing the Administrator Menu

Enter the following command to invoke the Administrator menu:

```
§ SLSMGR
```

Required Privilege:

Using SLS Menu Interfaces

2.3 Operator Menu

To access the Administrator Menu, you must have the OPER privilege.

2.2.2 Administrator Menu Diagram

Figure 2–1 shows SLS Administrator Menu

Figure 2–1 SLS Administrator Menu

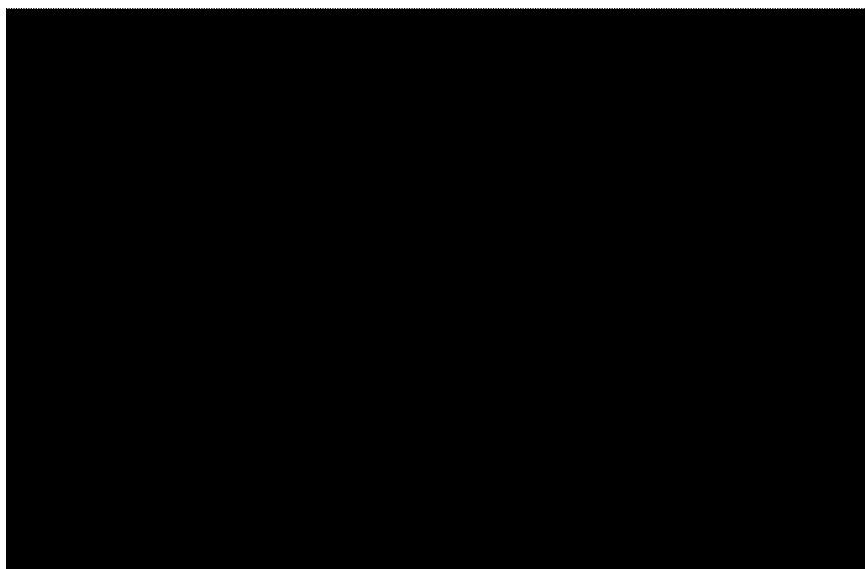

2.2.3 Administrator Menu Options

The Administrator Menu for SLS is the same as for MDMS. For a description of the Administrator Menu and information on using this menu to authorize database and volume pool access, see the *Media and Device Management Services for OpenVMS Guide to Operations, Chapter 2*.

2.3 Operator Menu

The Operator Menu provides access to various functions from a menu. All the functions available through the Operator Menu are also available through the STORAGE commands.

2.3.1 Accessing the Operator Menu

To access the Operator Menu, enter the following command at the DCL prompt:

```
$ SLSOPER
```

Required privilege:

To access the Operator Menu, you must have the OPER privilege.

2.3.2 Operator Menu Diagram

Figure 2–2 shows the Operator Menu.

Figure 2–2 Operator Menu

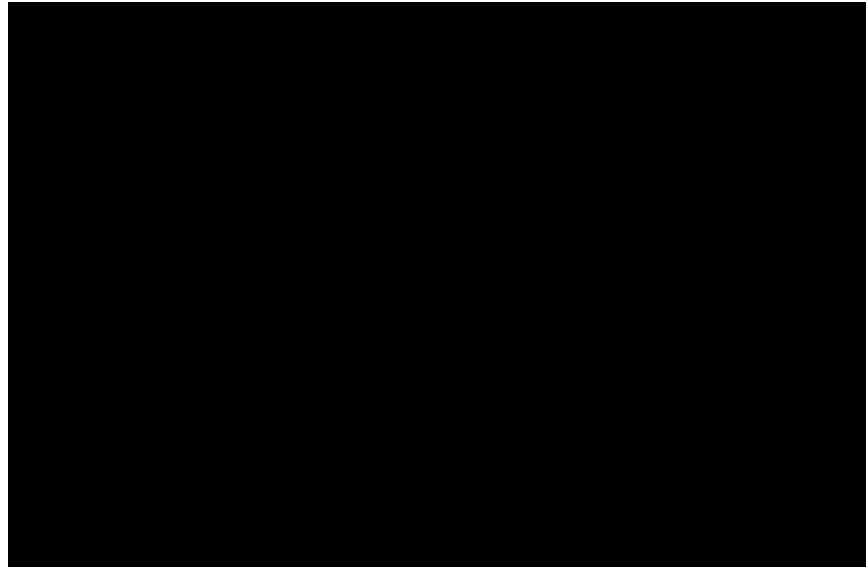

2.3.3 Operator Menu Options

Table 2–1 describes the options on the Operator Menu.

Table 2–1 Operator Menu Options

Option	Description
1. Manual System Backup	Through a series of questions, defines the parameters for a manual system backup; this information can be stored in a .COM file for later execution. For more information about performing manual system backups, see Section 6.2.
2. Save Screen	Provides a screen for defining parameters for a user save operation; this same screen is accessible from the User menu. For more information about performing user save operations, see Section 6.3.
3. Full Disk Restore	Through a series of questions, supplies the requirements to restore an entire disk. For more information about restoring a disk, see Section 7.2.
4. Restore Screen	Provides a screen for defining parameters for restoring files or groups of files; this same screen is accessible from the User menu. For more information about restoring files, see Section 7.3.
5. Release Volumes	Asks for a volume name and changes the volume's state from transition to free.
6. Update Clean Data	Sets the mount and error count fields to zero (0) for the specified volumes.
7. Initialize Volumes	Initializes specified volumes.
8. DCL Storage Command	Provides a DCL prompt at which you can enter any STORAGE command. Press RETURN from the DCL prompt to return to the Operator Menu.
9. Delete User Histories	Deletes user history files for a specified user or for all users before a specified date.

Using SLS Menu Interfaces

2.4 User Menu

Table 2–1 Operator Menu Options

Option	Description
10. Tapejoke Initialize Volume Series	Initializes a series of volumes contained in a jukebox. For more information about working with tape jukeboxes, see the <i>Media and Device Management Services for OpenVMS Guide to Operations</i> .
11. Maintenance	Brings up the Maintenance menu. For additional information, see the <i>Media and Device Management Services for OpenVMS Guide to Operations</i> .
12. Vault Management	Brings up the Vault Management menu which allows you to access information about when volumes go to vaults and return. For additional information, see the <i>Media and Device Management Services for OpenVMS Guide to Operations</i> .
13. Standby Archive	Controls standby archiving operations.
14. SYSCLN	Controls the SYSCLN program, which deletes old SLS history file records from each history set on the system.
15. ACS Management	Provides commands to work with volumes contained in a StorageTek ACS 4400 or StorageTek WolfCreek silo. For additional information about working with ACS silos, see <i>Media and Device Management Services for OpenVMS Guide to Operations</i> .
16. Free Volumes	Searches the volume database and creates a listing of all volumes whose state is FREE.
17. Allocated Volumes	Searches the volume database and creates a listing of all volumes whose state is ALLOCATED.
18. Down Volumes	Searches the volume database and creates a listing of all volumes whose state is DOWN.
19. Volumes in Transition	Searches the volume database and creates a listing of all volumes whose state is TRANSITION.
20. Volumes Due for Allocation	Searches the volume database and creates a listing of all volumes in sequential order for allocation.
21. Volumes Due for Cleaning	Searches the volume database and creates a listing of all volumes ready for cleaning.
22. Quantity Control	Searches the volume database and creates a volume usage report.

2.4 User Menu

The User Menu allows you to control user-initiated save and restore requests and provides various ways of viewing information about SLS-managed media.

2.4.1 Accessing the User Menu

To access the User Menu, enter the following command at the DCL prompt:

```
$ SLSUSER
```

2.4.2 User Menu Diagram

Figure 2–3 shows the User Menu

Figure 2–3 User Menu

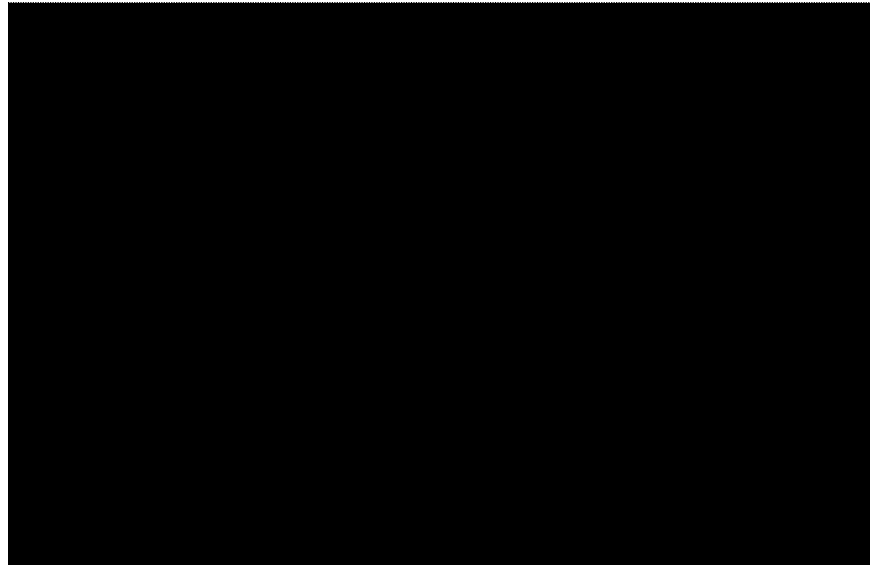

2.4.3 User Menu Options

Table 2–2 describes the options available on the User Menu.

Table 2–2 User Menu Options

Option	Description
1. Save Screen	Provides a screen for defining parameters for a user save operation; this same screen is accessible from the Operator menu. For more information about performing user save operations, see Section 6.3.
2. Restore Screen	Provides a screen for defining parameters for restoring files or groups of files; this same screen is accessible from the Operator menu. For more information about restoring files, see Section 7.3.
3. Show Volume	Displays information about the specified volume.
4. Deallocate Volume	Deallocates the specified volume.
5. Modify Scratch Date	Changes the date for the volume to return to the scratch pool.
6. Modify Volume Note	Changes information about the volume contained in the note.
7. DCL Storage Command	Provides a DCL prompt at which you can enter any STORAGE command. Press RETURN from the DCL prompt to return to the User Menu.
8. All Owned Volumes	Searches the volume database and creates a listing of all volumes owned by this user.
9. Volumes by Scratch Date	Searches the volume database and creates a listing of volumes and their scratch dates.

Table 2–2 User Menu Options

Option	Description
10. Files on User Backups	Searches user history files to generate a listing of user backup operations on a specified file or set of files.
11. Files on System Backups	Searches system history files to generate a listing of system backup operations on a specified file or set of files.

SLS Processes and Database Management

This chapter defines the client and server processes and describes their interoperability. This chapter also discusses the feature for tuning interprocess communication, and the management of the SLS database.

3.1 The SLS Server and Client Processes

SLS client and server processes ensure the volume and magazine databases are available when a data request is made. The software implements the server and client processes. These processes enable you to partition your work.

Server process:

The SLS server process is executed on a node where you set policy for storage management and maintain information of files, media, and volumes.

Client process:

The SLS client process is executed on a node where you create replicated files.

3.1.1 Client and Server Definitions

This section defines SLS's concepts of server and client. It is important that you understand what each provides for SLS functionality.

3.1.1.1 Server Software

SLS server software gives users access to the full functionality of SLS software. SLS provides this access at the node or OpenVMScluster system where the SLS software is executing.

SLS server software manages the:

- **Media database**—A set of RMS files that describe all removable storage media known to SLS software. These files are part of the Media and Device Management Services for OpenVMS (MDMS) portion of the SLS product. For detailed information about the MDMS databases, see the *Media and Device Management Services for OpenVMS Guide to Operations*.

A node or OpenVMScluster system executing SLS server software provides media management services both for itself and for any client nodes connected to it. The media database contains information about volume names, locations, magazines, tape jukeboxes, and pool access authorization.

- **SLS history files**—Information is recorded at the local node about user files backed up or archived under SLS control.

3.1.1.2 Client Software

SLS client software:

SLS Processes and Database Management

3.1 The SLS Server and Client Processes

- Provides backup scheduling and archiving services for the node or OpenVMSCluster system on which it is executing
- Acts as a client of another node executing SLS server software when it requires media management services
- Provides users with full functionality when a node or OpenVMSCluster system executing SLS client software is communicating with another node or OpenVMSCluster system executing SLS server software

Similar to the SLS server software, SLS client software also maintains historyfiles in which it records information about user files backed up or archived locally under its control.

The node executing SLS client software communicates using DECnet software to a server node running SLS server software. The server node maintains the media database.

3.1.2 Basic Block Diagram of SLS Server and Client Processes

This diagram shows the SLS server and client processes in a two-node configuration.

Figure 3-1 SLS Server and Client Processes

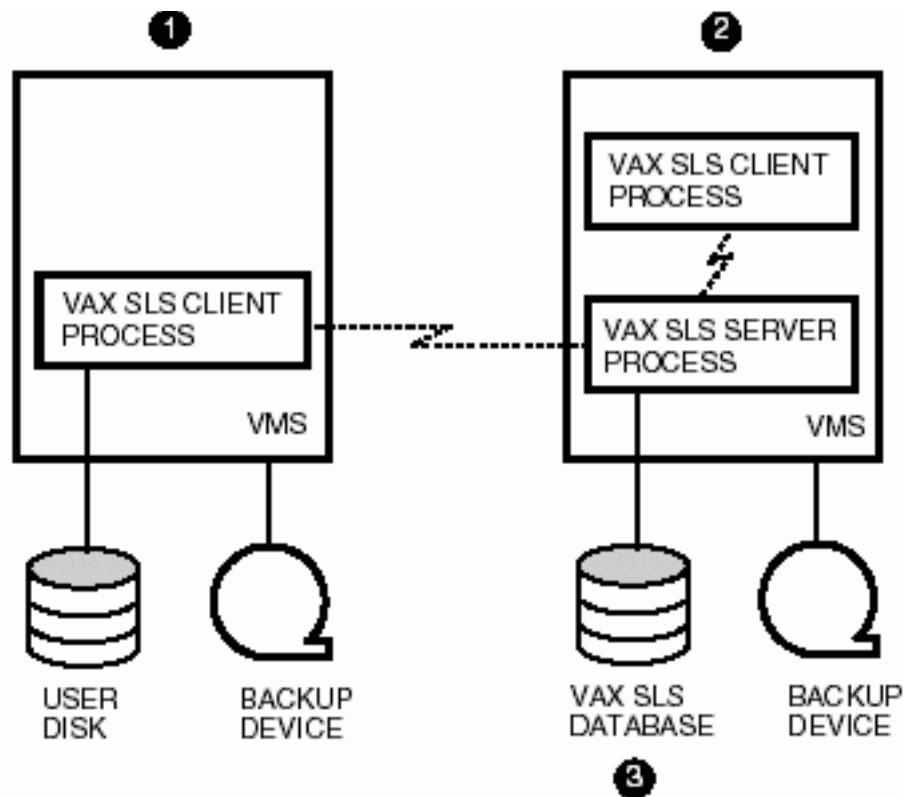

CXO-3326A

- 1 The SLS client node. This node runs the client process only. At this node, data is copied to the local device for safekeeping and statutory requirements.
- 2 The SLS server node. This node executes both the SLS server and client processes. At this node, the SLS server process maintains the volume and magazine databases.
- 3 The volume and magazine databases. These databases maintain records of media used for operations at both the server and client nodes.

3.2 The SLS Server Process in a OpenVMS Cluster System

When the SLS server software is installed on a OpenVMS Cluster system, the SLS server process can be active on only one node at any time. The **active server process** is responsible for all requests issued by any SLS client processes, whether from within our outside the OpenVMS Cluster system.

A **standby server process** is any SLS server process in the OpenVMS Cluster system other than the one currently processing requests from an SLS client process. A standby server process waits and becomes active if the active server process fails.

3.2.1 Establishing the Active Server Node

Table 3–1 describes how the SLS server process remains active on at least one node in a OpenVMS Cluster system.

Table 3–1 Establishing the Active Server Node

Table 3–1 Establishing the Active Server Node

Stage	Action
1.	As part of configuring SLS, you must identify the OpenVMS Cluster system nodes that are eligible to become the SLS server process.
2.	During startup, SLS uses the OpenVMS Distributed Lock Manager to select one of the nodes that you have identified as eligible to become a server node.
3.	The active server process: <ul style="list-style-type: none">• Is granted a lock to ensure it is the only active server process with direct access to the SLS databases.• Establishes itself as the named network object to accept requests from SLS client processes <p><u>Note:</u> As long as the active server process exists, it holds the lock in a restricted access mode.</p>
4.	The remaining OpenVMS Cluster system nodes executing the SLS server processes become standby SLS servers.
5.	The standby sever process on each node enqueues a request for the lock held by the active server node and waits for a response. If the active SLS server process fails, the VMS Distributed Lock Manager grants the lock to the subsequent SLS server process in the queue. <p><u>Note:</u> When necessary, this process repeats itself from Stage 3.</p>

3.3 SLS Client Process in the OpenVMS Cluster System

Regardless of its location in the system, the SLS client process performs the same functions:

- Handles the user interfaces
- Exists on every node that uses the SLS software, even the same node as the

SLS server process

SLS Processes and Database Management 3–3

SLS Processes and Database Management

3.3 SLS Client Process in the OpenVMS Cluster System

3.3.1 Establishing a Client Connection on a OpenVMS Cluster System

Table 3–2 describes how the SLS client process establishes a connection with a SLS server process running on a OpenVMS Cluster system.

Table 3–2 Establishing a Client Connection on a OpenVMS Cluster

Table 3–2 Establishing a Client Connection on a OpenVMS Cluster

Stage	Action
1.	The SLS client process sends a connection request to the OpenVMS Cluster system using the name assigned to the PRI symbol in the file TAPESTART.COM. DECnet software gives any of the OpenVMS Cluster system nodes the task of responding.
2.	The responding node: <ul style="list-style-type: none">• Determines the name of the node executing the active SLS server process (SLS server node)• Returns the node name to the requesting SLS client process
3.	The SLS client process sends a connect request directly to the SLS server node.
4.	The active SLS server process connects with the SLS client process and services the request.

SLS Processes and Database Management

3.3 SLS Client Process in the OpenVMS Clus-

Figure 3-2 Two-Node SLS Client-Server Process

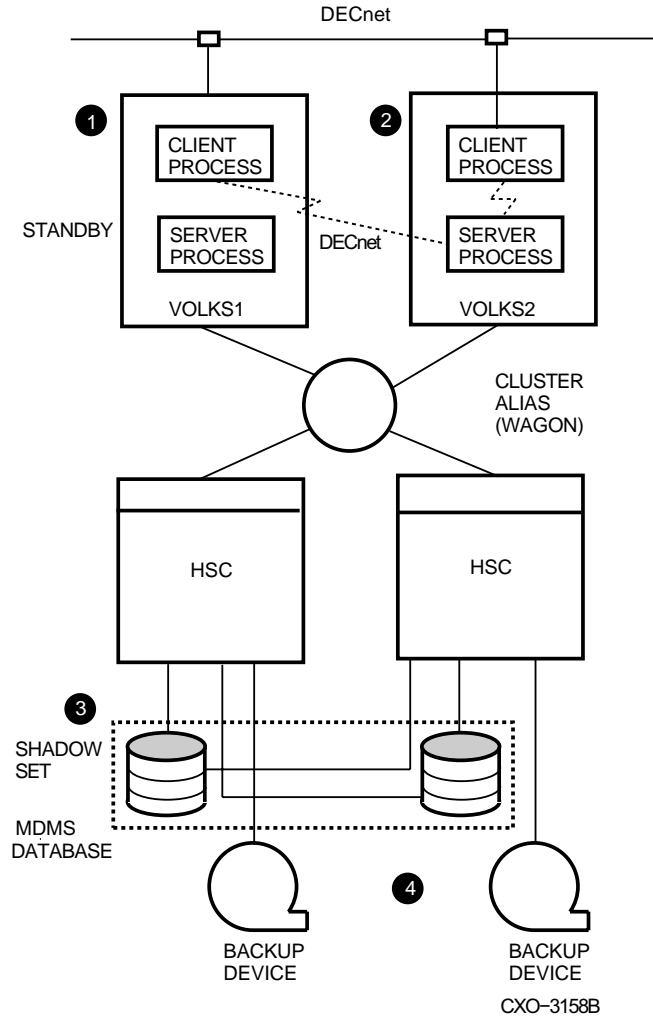

SLS Processes and Database Management

3.3 SLS Client Process in the OpenVMS Cluster System

- 1 This node (VOLKS1) executes the standby SLS server process. Its SLS client process communicates with the active SLS server process on node VOLKS2. In the event of a failure of the active SLS server process on VOLKS2, VOLKS1 would become the active server node.
- 2 This node (VOLKS2) executes the active SLS server process. In the event of a failure of the SLS server process on this node, VOLKS1 would become the active server node.
- 3 The SLS databases are maintained on a VAX Volume Shadow set. The SLS volume database maintains information about volumes created in this OpenVMS Cluster system.
- 4 The devices are available for backing up or archiving data from the OpenVMS Cluster system.

Figure 3-3 describes a three-node configuration that includes a two-node OpenVMS Cluster system and an additional node connected to the OpenVMS Cluster system. The third node in this diagram is not part of the OpenVMS Cluster system and is connected either through a wide-area DECnet connection or a mixed-interconnect OpenVMS Cluster system connection.

Figure 3-3 Three-Node SLS Client-Server Process

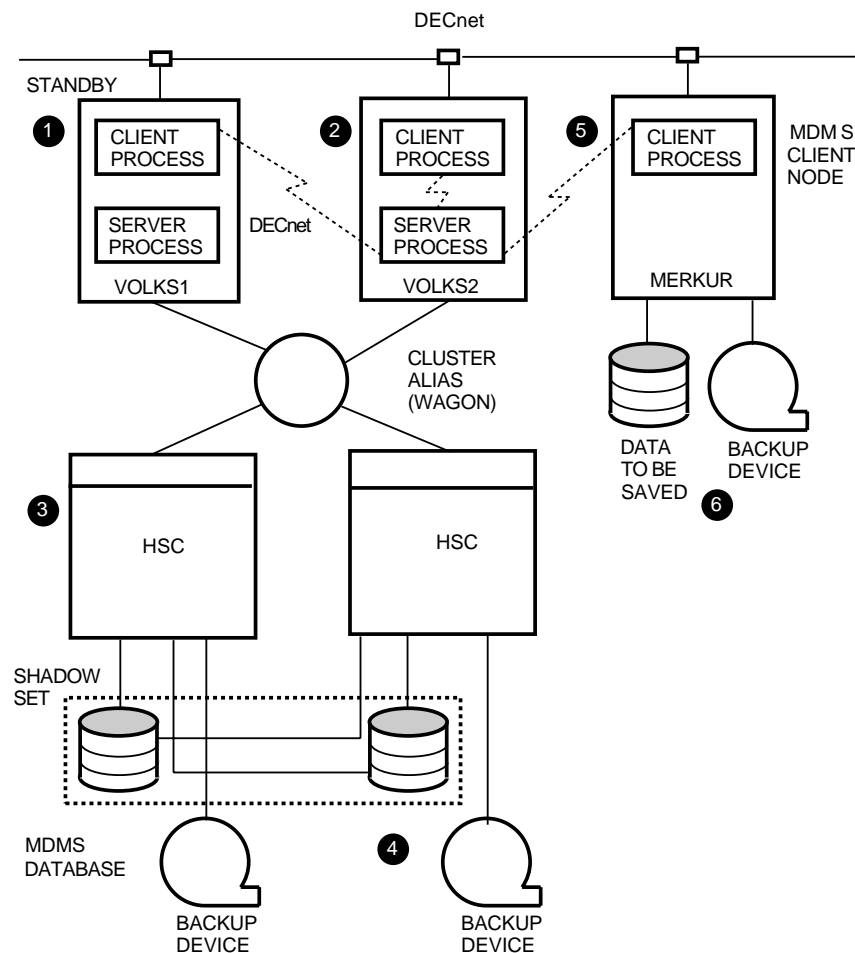

CXO-3159C

- 1 This node (VOLKS1) executes the standby SLS server process. Its SLS client process communicates with the active SLS server process on node VOLKS2. In the event of a failure of the active SLS server process on VOLKS2, VOLKS1 would become the active server node.

SLS Processes and Database Management

3.3 SLS Client Process in the OpenVMS Clus-

- 2 This node (VOLKS2) executes the active SLS server process. In the event of a failure of the SLS server process on this node, VOLKS1 would become the active server node.
- 3 The SLS databases are maintained on a VAX Volume Shadow set. The SLS volume database maintains information about volumes created in this OpenVMS Cluster system.
- 4 The devices are available for backing up or archiving data from the OpenVMS Cluster system.
- 5 This node (MERKUR) is connected to the OpenVMS Cluster system by DECnet communications software. Only the SLS client process is required to run on node MERKUR. When a request is made from the SLS client process on MERKUR, a connection request is first made of the OpenVMS Cluster system alias name (WAGON). Next, the connection to the active SLS server process is made so the request can be served.
- 6 The information about the data copied and the volumes used for the backup operation is maintained in the SLS volume database, located on the OpenVMS Cluster system.

Figure 3–3 describes a five-node configuration that includes a three-node OpenVMS Cluster system plus an additional node connected to the OpenVMS Cluster system. This examples includes characteristics that apply to any configuration in which data is stored on a MSCP-served devices and RSM devices.

3.3.2 DFS Restrictions Using VMS Backup Utility

DFS (Distributed File Service) imposes restrictions on the use of the VMS Backup Utility. Therefore, any use of the SLS software in conjunction with DFS is subject to those restrictions. Refer to the Distributed File Service documentation for more information about those restrictions.

SLS Processes and Database Management

3.3 SLS Client Process in the OpenVMS Cluster System

Figure 3-4 Five-Node SLS Client-Server Process

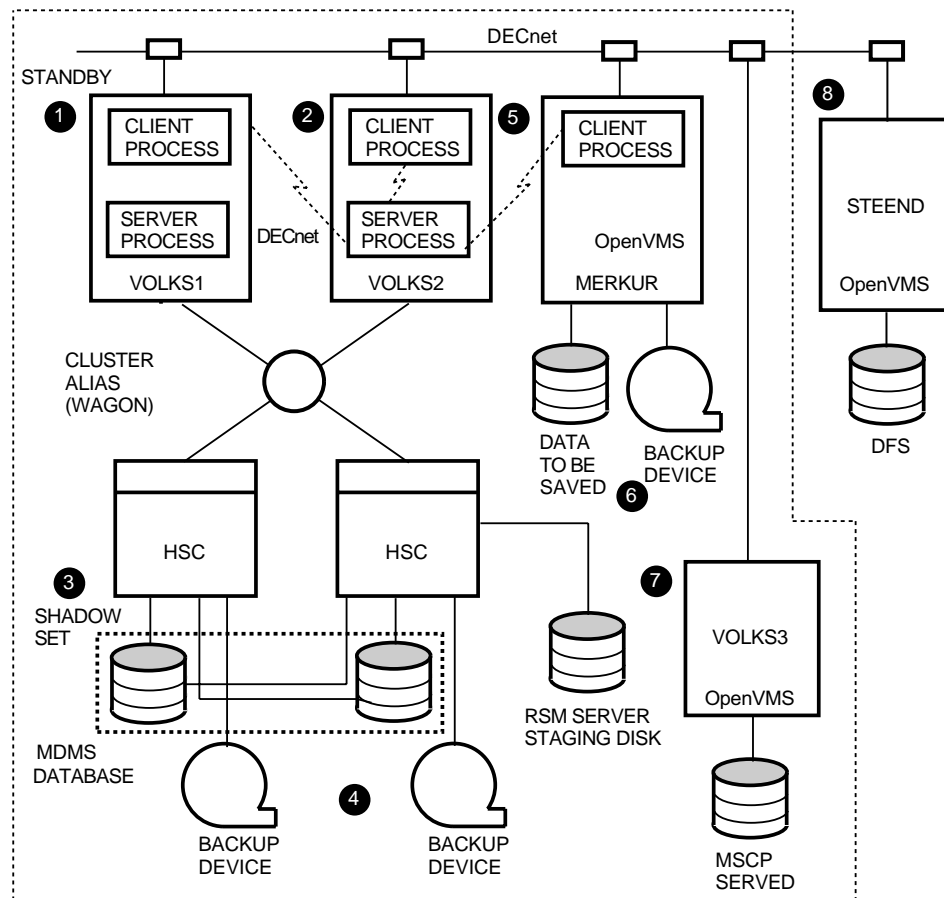

CXO-3160C

- 1 This node (VOLKS1) executes the standby SLS server process. Its SLS client process communicates with the active SLS server process on node VOLKS2. In the event of a failure of the active SLS server process on VOLKS2, VOLKS1 would become the active server node.
- 2 This node (VOLKS2) executes the active SLS server process. In the event of a failure of the SLS server process on this node, VOLKS1 would become the active server node.
- 3 The SLS databases are maintained on a VAX Volume Shadow set. The SLS volume database maintains information about volumes created in this OpenVMS Cluster system.
- 4 The devices are available for backing up or archiving data from the OpenVMS Cluster system. These devices can also be used for saving data from the DFS-served system (STEEND) and the MSCP-served device on VOLKS3.
- 5 The devices are available for backing up or archiving data from the OpenVMS Cluster system.
- 6 This node (MERKUR) is connected to the OpenVMS Cluster system by DECnet communications software. Only the SLS client process is required to run on node MERKUR. When a request is made from the SLS client process on MERKUR, a connection request is first made of the OpenVMS Cluster system alias name (WAGON). Next, the connection to the active SLS server process is made so the request can be served.
- 7 The information about volumes is maintained in the SLS volume database, located on the OpenVMS Cluster system.
- 8 The node VOLKS3 maintains data on a device that is MSCP-served to the OpenVMS Cluster system (WAGON). Data stored on the device connected to this node can be backed up onto the devices in the WAGON system.

SLS Processes and Database Management

3.4 How to Define the SLS Server Process

9 The node STEEND maintains data that is DFS-served from the OpenVMS Cluster system (WAGON). Data stored on the device connected to this node can be copied onto media on the devices in the WAGON system.

3.4 How to Define the SLS Server Process

To define the SLS server, assign the OpenVMS Cluster alias name to PRI symbol in the file SYSS\$MANAGER:TAPESTART.COM. If you assign a single node name to the symbol, you are dedicating that node as the server and disallowing any other nodes to act as standby servers.

To enable other members of the OpenVMS Cluster to act as server nodes, assign those node names to the DB_NODES symbol. If you are assigning more than one node, they must be entered in a comma-separated list.

Example: Assigning DB_NODES in TAPESTART.COM

```
$ DB_NODE := MERK1 ,MERK2 ,MERK3
```

Note

If you are running the SLS server on a single node, SLS ignores the DB_NODES symbol if it is not equal to the PRI symbol.

Additional Information:

See Section 12.1.1 for additional information about defining the SLS server.

3.5 How to Define the Client-Server Process Connection Timeout Value

Assign a value, in seconds, to the symbol NET_REQUEST_TIMEOUT in the file TAPESTART.COM. This value determines how long the SLS client process will wait for a response from a SLS server process before it times out.

On slower SLS server systems, or when the SLS databases become large, operations may take more time. Make sure this value is set high enough to avoid SLS client time-outs.

Default:

The fault value is 120 seconds.

```
$ NET_REQUEST_TIMEOUT := 120
```

Additional Information:

See Section 12.1.1 for additional information about defining the SLS client time-out value.

3.6 Optimizing SLS Database Files

Data files used by SLS software are constantly being updated. Over time, after many records are added and deleted, the internal organization of these files become less efficient. When this happens, the files take longer and longer to update.

By performing file optimization, the internal organization becomes more efficient and software performance is enhanced.

SLS Processes and Database Management

3.6 Optimizing SLS Database Files

3.6.1 Recommended Minimum Optimization

You can perform the recommended minimum file optimization by executing the DCL CONVERT command. This command creates a file with a version number one higher than that of the input file.

Requirement:

Because SLS software maintains the lock on its database files, you must *shutdown* the SLS process *before* doing the file optimization procedure.

Example:

To optimize the performance on the file TAPEMAST.DAT, enter the following command:

```
$ @SLS$SHUTDOWN DB  
  
$ CONVERT TAPEMAST.DAT TAPEMAST.DAT
```

More information:

For additional information about using the CONVERT command, refer to the *VMS Convert and Convert/Reclaim Utility Manual*.

3.6.2 How to Optimize Files Using FDL

Once a data file has been in use for a significant number of updates, you can optimize the file based upon the statistics of its usage. To do this, edit the file's File Definition Language (FDL) specification.

Requirement:

Because SLS software maintains the lock on its database files, you must *shutdown* the SLS process *before* performing the file optimization procedure.

Table 3–3 How to Optimize a SLS Data File

Table 3–3 How to Optimize a SLS Data File

Step	Action
1.	Shutdown the SLS process: <pre>\$ @SLS\$SHUTDOWN DB</pre>
2.	Produce an analysis file on the data file by entering the ANALYZE command: <pre>\$ ANALYZE/RMS_FILE/FDL SLS\$MASTER:TAPEMAST.DAT</pre> <p><u>Result:</u> Produces a file named TAPEMAST.FDL</p>
3.	Direct the FDL editor to produce an optimized FDL file. No interaction is required. Specify the same FDL file name for both the input analysis file and the output file. Enter the following command: <pre>\$ EDIT/FDL/NOINTERACTIVE/ANALYSIS=TAPEMAST.FDL TAPEMAST.FDL</pre> <p><u>Result:</u> A new version of TAPEMAST.FDL is created in a state ready for file optimization.</p>
4.	Convert the original data file with the newly created .FDL file. Enter the following command: <pre>\$ CONVERT/FDL=TAPEMAST.FDL/NOSORT/STATISTICS TAPEMAST.DAT TAPE- MAST.DAT</pre> <p><u>Result:</u> The TAPEMAST.DAT file has been optimized based upon its previous usage.</p>

SLS Processes and Database Management
3.6 Optimizing SLS Database Files

SLS Catalog Safety and Maintenance

Just as your organization must keep its data safe, you must also protect the data in your volume and magazine databases. There are recommended methods to ensure SLS data safety. Each method has its own cost with regard to capital investment, personnel involvement, and the time required to make lost data available.

You can implement any one or combination of the following methods to ensure SLS data safety:

- Frequent backup operations with the VMS Backup utility
- File transaction logging with VAX RMS Journaling software
- Creating a shadow set under VAX Volume Shadowing software

Comparison of SLS data safety methods:

Each data safety method described in the following table explains the cost of data loss in the event of a device failure, and lists the advantages and disadvantages of each method.

Data safety method	When the device fails...	Advantages	Disadvantages
Frequent save operations	You can restore data up to the last time it was saved.	<ul style="list-style-type: none"> • Not as expensive to implement as the other two methods 	<ul style="list-style-type: none"> • Can cause gaps in data coverage • Requires you to shut down the SLS server process during the save operation • Can require a long time to restore data during which you cannot use the SLS software

SLS Catalog Safety and Maintenance

4.1 Volume Database Location

Data safety method	When the device fails...	Advantages	Disadvantages
Frequent save operations supplemented with VAX RMS Journaling software	You can restore data up to the time the device failed.	<ul style="list-style-type: none"> Provides less exposure to data loss than with save operation alone 	<ul style="list-style-type: none"> Requires additional software Requires you to plan for journal safety Requires you to shut down the SLS server process during save operations Uses a journal file which can grow large, consuming on-line storage space Requires a time-consuming process to restore data
VAX Volume Shadowing software	There is no need to restore data when a storage device fails.	<ul style="list-style-type: none"> Retains more than one viable copy of the database on-line Does not require you to shut down SLS software 	<ul style="list-style-type: none"> Requires an additional device Requires additional software

4.1 Volume Database Location

Consider data safety and availability when choosing the location of the volume database. Depending on the data safety methods you employ, you can set up your database on the system disk, or on some other device.

Assign the name of the device and directory in which SLS servers will find the volume database to the PRIMAST symbol in the SYS\$MANAGER:TAPESTART.COM file.

Default:

The default device and directory for the volume database is:

```
$ PRIMAST ::= SLS$ROOT:[PRIMAST]
```

4.2 SLS History Files

SLS system history files contain information about files saved by SLS software. This enables you to locate the saved copy of the file you want to restore. SLS history files:

- Provide a means of searching for more than one backup copy of the same file
- Help to determine the contents of a save set without restoring it

SLS history files contain the records of:

- Save set names
- Date and time the save set is created
- Names of the files in the save set
- Volume ID of the backup volume

Considerations for History File Location

Next to the volume database, the most important files are the SLS system history files. There are many considerations you can make when determining where to place your SLS system history files. Some of them include:

- Your data safety strategy
- Your backup operations frequency
- The number of backup operations you want to track for any given file
- The amount of on-line storage space you have for SLS system history files

Types of SLS History Files

There are two types of SLS history files depending upon the type of backup operation:

1. User history files
2. System history files

SLS history file sets can be created for different types of backups. They might include:

- Daily
- Weekly
- Monthly
- A specific period of time (depending upon how you define the SLS history file parameters in the TAPESTART.COM file)

SLS History Files Sets

The SLS history is maintained as a set of two file types:

1. The Files file, which contains a record for each file backed up by SLS software.
2. The Sets file, which contains record for every save set written to a volume.

4.2.1 Creating SLS System History Files for System Backup Operations

To create and update SLS system history files, you must identify the:

- Directory and name of the SLS system history files with the HISNAM_n and HISDIR_n symbols in the SYSS\$MANAGER:TAPESTART.COM file
- SLS system history file name in your system backup command file

If You Do Not Want SLS System History Files:

If you do not want SLS system history files, do not make an assignment to the HISNAM_n or HISDIR_n symbols in the SYSS\$MANAGER:TAPESTART.COM file.

4.2.1.1 Naming Your SLS System History File Sets

Assign your SLS system history set name to a HISNAM_n symbol. For each SLS history set name, assign one symbol beginning with HISNAM_1, continuing with HISNAM_2, and HISNAM_3, for all assignments made.

Required assignment:

For each HISNAM_n symbol assignment, there must be a corresponding HISDIR_n symbol assignment.

SLS Catalog Safety and Maintenance

4.2 SLS History Files

Maximum number of history file sets:

There is an absolute maximum of 124 SLS system history file sets that can be maintained. However, the combined length of all SLS system history set names, separated by commas, must not exceed 980 characters.

4.2.1.2 Defining SLS System History File Set Directories

Assign a HISDIR_n symbol to your SLS system history file set directory. For each file set name, assign one symbol beginning with HISDIR_1, continuing with HISDIR_2, and HISDIR_3, for all assignments made.

Required assignment:

For each HISDIR_n symbol assignment, there must be a corresponding HISNAM_n symbol assignment.

4.2.1.3 Rules for SLS System History File Set Names and Directories

These rules apply to the specification of SLS system history file set names and directories:

- The HISDIR_n symbol must consist of a device and directory specification.
- The directory assigned HISDIR_n must be enabled for World Read access.
- Each SLS system history set must be kept in a separate directory.
- If the SLS system history files are to be spread over many directories, the HISDIR_n symbol may be assigned a logical name search list of the directories.

4.2.1.4 Example: SLS System History File Assignments

The following example shows SLS system history file set name and directory assignments.

Single assignment:

If you have a SLS system history set for image backup operations on a disk named LARGE_DISK_1, you could assign the following:

```
$ HISNAM_1 := FULL  
  
$ HISDIR_1 := LARGE_DISK_1:[SYSDISK.FULL]
```

4.2.1.5 Characterizing SLS System History Files

Each SLS system history file requires an SBATTR.COM file to characterize the amount of historical information that will be maintained. Refer to Section 1.2.2 for more information.

4.2.2 Defining Characteristics of SLS System History Sets

Defining the characteristics of SLS system history sets involves balancing the need for information about the copies of saved data with the amount of storage space consumed by that information.

SLS software uses the SBATTR.COM file to characterize the SLS system history sets. The default directory for SLS system history files is SLS\$ROOT:[HIST], and is identified by HISNAM_1 and HISDIR_1 in the SYS\$MANAGER:TAPESTART.COM file. This directory contains the SBATTR.COM file.

Requirement:

An SBATTR.COM file must reside in each directory identified by a HISDIR_n assignment. If an SBATTR.COM file does not exist, then the first time files are processed into that SLS system history set, the SBATTR.COM file from SLS\$ROOT:[HIST] is copied into the directory.

4.2.2.1 Determining the Space Required for SLS System History File Sets

You determine the amount of space required in the SLS system history file for each file saved with the SBATTR.COM command file. Consider the following items:

- The number of records per file saved
- The maximum size of the file name stored
- The maximum number of SLS system history files saved for each file
- Whether or not the node name is stored

Important:

Do not delete any files in the SLS system history file directory, and do not edit any file other than SBATTR.COM.

4.2.2.2 History Records for Individual File Versions

You choose to maintain records for multiple versions or the most recent version of files saved by assigning either of the allowable values from Table 4–1.

Table 4–1 Values for SEPARATE_VERSION

IF you...	THEN assign...
Want explicit reference to each version of file version numbers	<code>\$ SEPARATE_VERSION == 1</code>
<p><u>Result:</u> Consumes more storage space because each version has to occupy a separate record for each version in the Files file.</p>	
Do not require explicit reference by version	<code>\$ SEPARATE_VERSION == 0</code>
<p><u>Result:</u> Saves storage space in the Files file because each file saved has only one record, regardless of the number of versions saved.</p>	

4.2.2.3 Declaring the Maximum File Name Size

SLS uses the value assigned to the FILENAME_SIZE symbol as a key to determine the length of the file name stored in the SLS system history files.

Depending on the length of the key, the file name can include:

- Node name without the double colon (::)
- Device name without the single colon (:)
- Directory, excluding the root directory
- File name and type, but not the version

Considerations/Recommendations:

The storage administrator determines the length of the file name. Consider the following when making this decision:

- If directory structures contain many levels, assign a large value. When processing, the SBATTR.COM file adds four characters to the primary key. Because the SBATTR.COM file adds four characters to the primary key, you can define a maximum value of 251 for the FILENAME_SIZE symbol.

Keep in mind that larger values consume more storage space.

- If directory structures do not contain many levels, assign a smaller value.

The default value of 124 is recommended. Assigning a smaller value creates the potential for file names that are not unique.

Example:

```
$ FILENAME_SIZE == 124
```

4.2.2.4 Declaring the Maximum Number of SLS System History Pointers Per File

If more than one copy of the same file is saved, the SLS system history file keeps track (with the use of pointers) of each separate volume on which a copy of the file resides.

The POINTERS symbol determines the number of versions SLS retains for each file. Once the number of pointers is exceeded, SLS overwrites the oldest version of the file.

Default:

The following example shows the default value for POINTERS.

```
$ POINTERS == 4
```

Changing values:

Once you establish a number of pointers for your particular SLS system history file, you can change them only through a conversion process. Otherwise, changing the pointers to a lower or higher value causes errors.

Follow the steps in Table 4–2 to increase or decrease pointer values. To illustrate how this works, consider the following example:

Example:

Two history sets defined in SYSS\$MANAGER:TAPESTART.COM:

```
$ HISNAM_1 := GENERIC  
  
$ HISDIR_1 := SLS$ROOT:[HIST]  
  
$ HISNAM_2 := MY_HIST  
  
$ HISDIR_2 := SLS$ROOT:[HIST.MY_HIST]
```

The history set MY_HIST was created with the default POINTERS value of 4. Now, there is a need for 8 pointers.

Table 4–2 How to Change Pointer Values

Step	Action
1	<p>Edit SY\$MANAGER:TAPESTART.COM and create a new HISNAM and HISDIR symbol for each new history set that you want to change the POINTER value.</p> <p><u>Example:</u></p> <pre> \$ HISNAM_1 := GENERIC \$ HISDIR_1 := SLS\$ROOT:[HIST] \$ HISNAM_2 := MY_HIST \$ HISDIR_2 := SLS\$ROOT:[HIST.MY_HIST] \$ HISNAM_3 := YOUR_HIST \$ HISDIR_3 := SLS\$ROOT:[HIST.YOUR_HIST] </pre>
2	<p>Restart the SLS software using the following command:</p> <pre>@SYS\$STARTUP:SLS\$STARTUP</pre> <p><u>Result:</u> Automatically creates the new history directory SLS\$ROOT:[HIST.YOUR_HIST] defined in TAPESTART.COM.</p>
3	<p>Copy SBATTR.COM from SLS\$ROOT:[HIST] directory to the new history directory.</p> <pre>\$ COPY SLS\$ROOT:[HIST]SBATTR.COM [new_directory]</pre>
4	<p>Edit SBATTR.COM in the new directory and assign the desired value to the POINTERS symbols in the new history directory.</p>
5	<p>Edit all *_SBK.COM files with the HISTORY_SET defined as MY_HIST. Assign the value to the symbol HISTORY_SET to point to the new history names assigned to the HISNAM symbol in SY\$MANAGER:TAPESTART.COM.</p> <pre>\$ HISTORY_SET ::= YOUR_HIST</pre> <p><u>Result:</u> The next system backup operation with HISTORY_SET defined as "YOUR_HIST" will cause the SLS software to initialize a new history set file (\$YOUR_HIST.DAT), with the number of pointers you assigned in SBATTR.COM.</p> <p><u>Note:</u> When restoring files, search both history sets, MY_HIST and YOUR_HIST, to locate the files.</p> <p style="text-align: center;">Important</p> <p>Do not delete any of the old history directories after this change has been made. They must remain on the system to obtain history reports for files that were backed up prior to this change.</p>

4.2.2.5 Choosing to Store the Node Name in the Files File

Choose whether to save the node name in the Files file by assigning one of the allowable values to NULL_NODE from Table 4–3.

SLS Catalog Safety and Maintenance

4.2 SLS History Files

Table 4–3 Values for NULL_NODE

IF you...	THEN assign...
Want to save the node name in the file	\$ NULL_NODE == 0
Do <u>not</u> want to save the node name in the file	\$ NULL_NODE == 1 <u>Recommendation:</u> Assign this value for files saved from an Open-VMSccluster system.

4.2.3 Transferring Existing Backup Files to SLS History Files

You can put information about existing backup files into an SLS history file.

4.2.3.1 Requirements for Transferring Files

Information can be entered into an SLS history file about existing backup files, if the volumes:

- Were written with the DCL BACKUP command and the command line was not greater than 512 bytes
- Were entered into the volume database, are allocated, and are in the proper sequence (for example, when you type STORAGE REPORT VOLUME the list of volumes is in the proper sequence)
- Included the density attribute in the database that reflects the density of the tape

4.2.3.2 Adding Existing Backup Files to the SLS Catalog

There are two methods to use for transferring existing backup files to SLS history files.

- IF you do not have a listing of old volumes available, THEN use method 1.
- ELSE use method 2.

Method 1:

Choose the one of the commands shown in Table 4–4:

Table 4–4 Transferring Existing Backup Files if no Listing Available

IF you...	THEN...
Do not want to automatically update the SLS history file	Enter the following commands: \$ SUBMIT/USER=SLS SLS\$\$SYSTEM:SYSOLDTAPE.COM/- _ \$ PARAMETER=("",first_volume,save_set,n_drives) \$ SUBMIT/USER=SLS SLS\$\$SYSTEM:SBUPDT.COM/- _ \$ PARAME- TER=(SLS\$TEMP_HISTORY:first_volume.hst;,history_set)
Want the SLS history file to automatically update	Enter the following command: \$ SUBMIT/USER=SLS SLS\$\$SYSTEM:SYSOLDTAPE.COM/- _ \$ PARAMETER=(history_set,first_volume,save_set,n_drives)

Where:

history_set	is the name of the history file you want to update.
first_volume	is the label of the first volume in the volume set.
save_set	is the name of the save set which can include the wildcard characters (*) or (%).
n_drives	is the number of drives needed. The default is 1.

Method 2:

Enter the following command:

```
$ SUBMIT/USER=SLS SLS$SYSTEM:SYSREADLIST.COM/-  
_ $ PARAMETER=(listing_file,first_reel,history_set)
```

Where:

listing_file	is the name of the listing file, including device and directory.
first_reel	is the Volume ID of the first reel in which the save_set resides.
history_set	is the name of the SLS history set where data is loaded.

4.2.4 Creating SLS User History Files For User Backup Operations

SLS history files enable users to retrieve files from volumes that they own, and does not require intervention to search for the backup volume. If you enable user backup operations, then you must decide where the SLS user history files will be located.

4.2.4.1 Considerations for User History Files

Consider using the same amount of storage space for SLS user history files as you did for the SLS system backup history files.

The logical name SLS\$USRBAK located in the file named SLS\$PARAMS:ASNUSR-BAK.COM, defines the location of the SLS user history file in the user's process logical name table. This command file executes when each user logs in.

To create and update SLS user history files, you must use one of the following methods:

- Save the files with the Save Screen of the Operator or User Menu (Section 6.3.)
- Enter the STORAGE SAVE command with the /RECORD qualifier (*Storage Library System for OpenVMS Command Reference Guide*)

4.2.4.2 How to Determine the SLS User History File Location

Table 4–5 describes the values allowed for the SLS\$USRBAK logical in SLS\$PARAMS:ASNUSRBAK.COM. This value determines the location of the SLS user history files.

SLS Catalog Safety and Maintenance

4.3 Deleting Old SLS History Files

Table 4–5 Values for SLS\$USRBAK Logical

IF you want SLS user history files located...	THEN enable option ...
For each user in a common directory	1 <u>Result:</u> Places the files in the SLS\$ROOT:[USRBAK] common directory.
In a subdirectory of the user's SYSS\$LOGIN directory This option places the files in a subdirectory of [.SLS] under the SYSS\$LOGIN directory that is automatically created by SLS.	2 <u>Result:</u> Names the files by the user name under the subdirectory of [.SLS].
In a common directory for each group	3 <u>Result:</u> The common directory is SLS\$ROOT:[USRBAK].
In the user's SYSS\$LOGI directory	4 <u>Result:</u> Names the files by user name.

How to enable or disable options:

- Enable-Remove the comment (!) marks from the command lines to execute.
- Disable-Enter comment marks on the command lines you do not want to execute.

4.3 Deleting Old SLS History Files

The SYSCLN (system clean) program deletes old SLS history file records from each SLS system history set on the system. SYSCLN cleans up old entries in the SLS history files by:

- Deleting old null pointers that point to freed volumes
- Performing RMS conversion on the data files

The result is more efficient file access and the conservation of disk space.

You can enable the SYSCLN process to run automatically by defining the SYSCLN_RUN symbol in the file named SYSS\$MANAGER:TAPESTART.COM.

4.3.1 The CLEANUP Process

The CLEANUP process is a batch job that cleans up the SLS files by performing the following actions:

Stage	Action
1	Checks the following assignments in the SYSS\$MANAGER:TAPESTART.COM file: <ul style="list-style-type: none"> • TRANS_AGE • ALLOCSCRATCH • BACKUPSCRATCH • MAXSCRATCH
2	Purges: <ul style="list-style-type: none"> • .LOG files • .LIS files • SYSBAK files • Old copies of the SLS\$MASTER directory
3	Starts SYSCLN.COM to finish cleanup processing.

4.3.1.1 Cleaning SLS System History Files

SYSCLN is a procedure that cleans up old entries in the SLS history files by:

- Deleting old null pointers that point to freed volumes
- Performing RMS conversion on the data files

The result is more efficient file access and the conservation of disk space.

4.3.1.2 The SYSCLN and CLEANUP Relationship

SYSCLN can be started by CLEANUP on any day beginning at the time indicated in the CLEANUP_Q assignment. SYSCLN stops after the assigned number of hours have passed for the given day. The next time SYSCLN is started by CLEANUP, it starts cleaning from where it stopped.

4.3.1.3 Controlling the Cleanup Process

The assignments to the CLEANUP_Q symbol specify the name of the batch queue that will run the CLEANUP process and the time of day the CLEANUP process will be run.

Allowed qualifiers: You can include any of the allowed qualifiers for the DCL SUBMIT command as part of the CLEANUP_Q assignment.

Restrictions: This table shows restrictions, reasons, and recommendations for the assignments to CLEANUP_Q.

SLS Catalog Safety and Maintenance

4.3 Deleting Old SLS History Files

You MUST...	Because...
ensure the queue selected will execute on the same node where SYSS\$MANAGER:TAPE-START.COM was executed	another node may have a different SYSS\$MANAGER:TAPESTART.COM file and different assignments to the symbols. The symbols that the cleanup process looks at must be correct for the node where SYSS\$MANAGER:TAPESTART.COM is executed.
set the time to when there will be no volume request to process	the CLEANUP process will hold SLS volume requests while it is running.

4.3.1.4 Setting the Days and Durations for Cleaning SLS History Files

Assign the days and durations which the SYSCLN process is permitted to run to the SYSCLN_RUN symbol.

The CLEANUP_Q default assignment selects the normal SLS batch queue and sets the time to run at 3:00 a.m. The default assignment is:

```
CLEANUP_Q := 'F$EXTRACT(0,F$LOCATE("/ ",BATN),BATN)'/AFTER=03:00
```

Example:

This example shows the CLEANUP_Q assignment and explains the SYSCLN_RUN assignments.

```
$ CLEANUP_Q := 'F$EXTRACT(0,F$LOCATE("/ ",BATN),BATN)'/AFTER=04:00
$ SYSCLN_RUN := WED=03,FRI=03,SAT=51
```

- On Wednesdays, SYSCLN starts at 04:00 and runs for three hours.
- On Fridays, SYSCLN starts at 04:00 and runs for three hours.
- On Saturdays, SYSCLN starts at 04:00 and runs for a maximum of 51 hours.

Rule:

Use only the three letter abbreviation for the name of the day.

4.3.2 SYSCLN Menu

The SYSCLN Menu allows you to control the SYSCLN program. SYSCLN deletes old SLS history file records from each history set on the system. Figure 4–1 shows the options available on the SYSCLN Menu.

Description

The SYSCLN Menu option displays a screen that allows you to:

- Manually start the SYSCLN program
- Inquire about SYSCLN status
- Abort SYSCLN processing
- Shut down the SYSCLN program

Procedure

Perform the steps described in Table 4–6 to access the SYSCLN Menu.

Table 4–6 Accessing the SYSCLN Menu

Step	Action
1	Enter 14 from the Operator Menu and press Return. <u>Result:</u> The software displays the SYSCLN Menu.
2	Enter the number next to the desired option and press Return. <u>Result:</u> The software displays the selected menu.
3	Enter Ctrl/Z, or enter Q and press Return, to exit the menu.

SYSCLN Menu Diagram

Figure 4–1 shows the options available on the SYSCLN Menu.

Figure 4–1 SYSCLN Menu

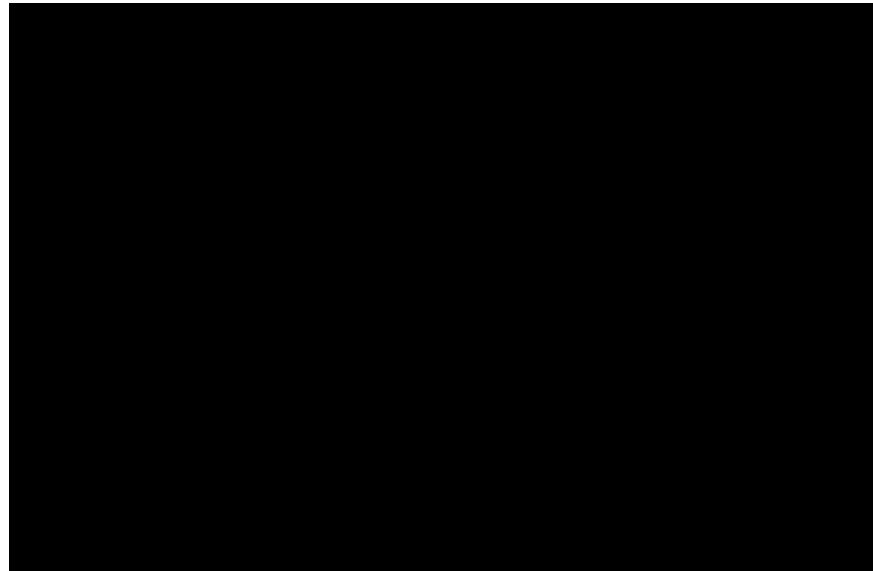

Menu Options

Table 4–7 describes the SYSCLN Menu options.

Table 4–7 SYSCLN Menu Options Descriptions

Option	Function
1. Start SYSCLN Processing	Begins the SYSCLN program. Refer to Section 4.3.2.1 for instructions about using this option.

SLS Catalog Safety and Maintenance

4.3 Deleting Old SLS History Files

Table 4–7 SYSCLN Menu Options Descriptions

Option	Function
2. Shutdown SYSCLN Processing	Shuts down the currently running SYSCLN process. Refer to Section 4.3.2.2 for instructions about using this option.
3. Inquire SYSCLN Status	Displays the current time and status of the running SYSCLN process. The software displays the name of the set being cleaned, the directory name, and the current process phase. Refer to Section 4.3.2.3 for instructions about using this option.
4. Abort SYSCLN Processing	Aborts an active SYSCLN process. If the program is terminated before it completes, when SYSCLN is restarted, cleaning can begin from where the previous job ended. Refer to Section 4.3.2.4 for instructions about using this option.

4.3.2.1 Start SYSCLN Processing

Description

The Start SYSCLN Process option displays a screen that enables you to manually start the SYSCLN process.

Start SYSCLN Processing Screen Diagram

Figure 4–2 illustrates the Start SYSCLN Processing screen.

Figure 4–2 Start SYSCLN Processing Screen

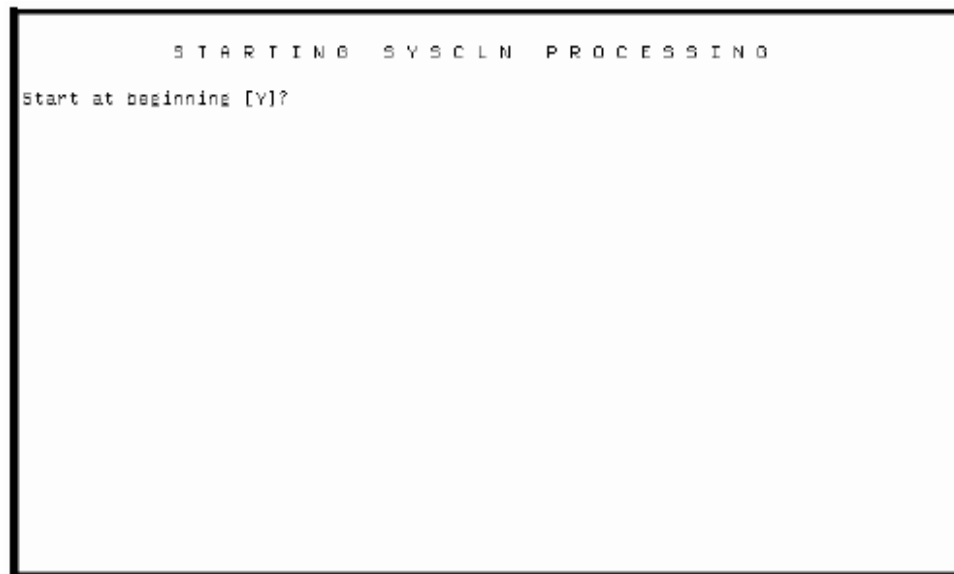

CXC-3214A

Procedure

Perform the steps described in Table 4–8 to use the Start SYSCLN Processing menu option.

Table 4–8 Start SYSCLN Processing

Step	Action
1	Enter 14 from the Operator Menu and press Return. <u>Result:</u> The software displays the SYSCLN Menu.
2	Enter 1 from the SYSCLN Menu and press Return. <u>Result:</u> <ul style="list-style-type: none"> The software displays the Starting SYSCLN Processing screen. The software displays the following message: <pre>Reply received on node_name from user SLS at node_name Batch hh:mm:ss SYSCLN job started</pre> If the previous SYSCLN job was terminated before it completed, the software asks if you want to start cleaning from the beginning of the system history file sets or from where the last job ended. The default [Y] starts the clean from the beginning. If you want to choose the default, press Return, otherwise, enter N.
3	Press Return to exit the screen.

4.3.2.2 Shutdown SYSCLN Processing

Description

The Shutdown SYSCLN Processing option displays a screen that enables you to shutdown the current SYSCLN process.

Shutdown SYSCLN Processing screen diagram

Figure 4–3 illustrates the Shutdown SYSCLN Processing screen.

Figure 4–3 Shutdown SYSCLN Processing screen

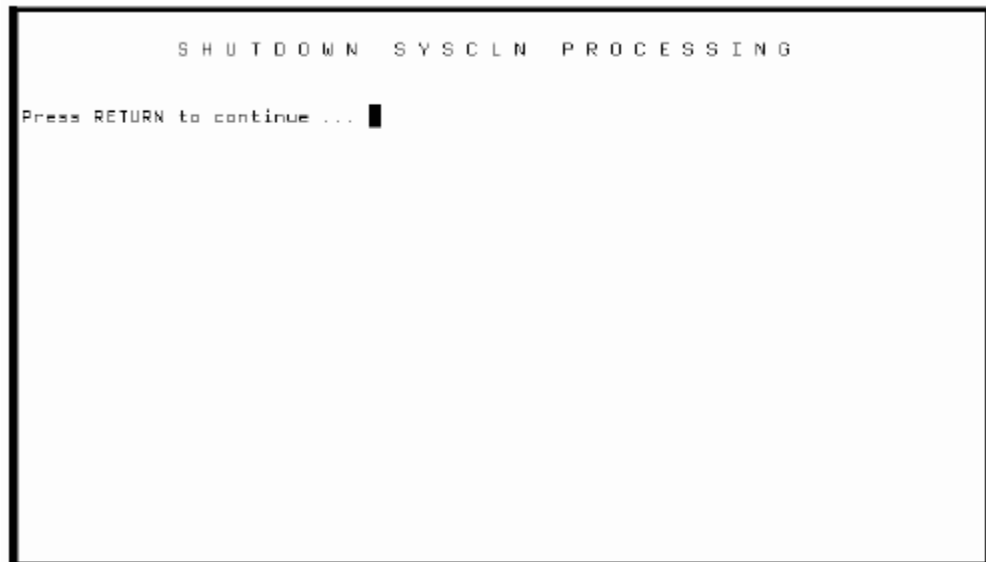

CXD-3211A

SLS Catalog Safety and Maintenance

4.3 Deleting Old SLS History Files

Procedure

Perform the steps described in Table 4–9 to use the Shutdown SYSCLN Processing menu option.

Table 4–9 Shutdown SYSCLN Processing

Step	Action
1	Enter 14 from the Operator Menu and press Return. <u>Result:</u> The software displays the SYSCLN Menu.
2	Enter 2 from the SYSCLN Menu and press Return. <u>Result:</u> <ul style="list-style-type: none"> IF SYSCLN is currently active, <u>THEN</u> the software displays the Shutdown SYSCLN Processing Menu and displays the following message: <pre>Reply received on node_name from user SLS at node_name Batch hh:mm:ss SYSCLN flagged for termination at dd-mmm- yyyymm:hh:mm:ss.cc</pre> ELSE (SYSCLN is currently inactive), the software displays a screen to inform you that SYSCLN is not running.
3	Press Return to exit the screen.

4.3.2.3 Inquire SYSCLN Status

Description

The Inquire SYSCLN Status option allows you to display the current time and status of the SYSCLN process.

Procedure

Perform the steps shown in Table 4–10 to use the Inquire SYSCLN Status option.

Table 4–10 Inquire SYSCLN status

Step	Action						
1	Enter 14 from the Operator Menu and press Return. <u>Result:</u> The software displays the SYSCLN Menu.						
2	Enter 3 from the SYSCLN Menu and press Return. <u>Result:</u>						
	<table border="1"> <thead> <tr> <th>IF...</th> <th>THEN...</th> </tr> </thead> <tbody> <tr> <td>The SYSCLN program is running.</td> <td>The software displays the Process ID and the current job. A new message displays every 6 seconds with an updated status.</td> </tr> <tr> <td>The SYSCLN program is not running.</td> <td>The software displays a message containing the following text: Currently inactive.</td> </tr> </tbody> </table>	IF...	THEN...	The SYSCLN program is running.	The software displays the Process ID and the current job. A new message displays every 6 seconds with an updated status.	The SYSCLN program is not running.	The software displays a message containing the following text: Currently inactive.
IF...	THEN...						
The SYSCLN program is running.	The software displays the Process ID and the current job. A new message displays every 6 seconds with an updated status.						
The SYSCLN program is not running.	The software displays a message containing the following text: Currently inactive.						

Table 4–10 Inquire SYSCLN status

Step	Action
3	Press Return to exit the screen.

SLS Catalog Safety and Maintenance

4.3 Deleting Old SLS History Files

4.3.2.4 Abort SYSCLN Processing

Description

The Abort SYSCLN Processing option displays a screen that allows you to abort the currently running SYSCLN job.

Procedure

Perform the steps described in Table 4–11 to use the Abort SYSCLN Processing menu option.

Table 4–11 Abort SYSCLN Process

Step	Action						
1	Enter 14 from the Operator Menu and press Return. <u>Result:</u> The software displays the SYSCLN Menu.						
2	Enter 4 from the SYSCLN Menu and press Return. <table border="1"><thead><tr><th>IF...</th><th>THEN...</th></tr></thead><tbody><tr><td>SYSCLN is currently running.</td><td>The software displays the current Process ID, the process name, user, priority, and default file specification and prompts "OK to abort [Y]?"</td></tr><tr><td>SYSCLN is not currently running.</td><td>The SLS software replies with the following message: SYSCLN is NOT running</td></tr></tbody></table>	IF...	THEN...	SYSCLN is currently running.	The software displays the current Process ID, the process name, user, priority, and default file specification and prompts " OK to abort [Y]? "	SYSCLN is not currently running.	The SLS software replies with the following message: SYSCLN is NOT running
IF...	THEN...						
SYSCLN is currently running.	The software displays the current Process ID, the process name, user, priority, and default file specification and prompts " OK to abort [Y]? "						
SYSCLN is not currently running.	The SLS software replies with the following message: SYSCLN is NOT running						
3	Enter Y to abort the process. <u>Result:</u> The currently running SYSCLN process is immediately stopped and the software displays a message stating that the SYSCLN process has been aborted.						
4	Enter Ctrl/Z or press Return to exit the screen.						

4.3.3 Delete User Histories

Description

The Delete User Histories option displays a screen that allows you to delete user history files for:

- Volumes that are associated with a specified user name
- Volumes for all user names before a specified date

Figure 4–4 Delete User Histories Screen Diagram

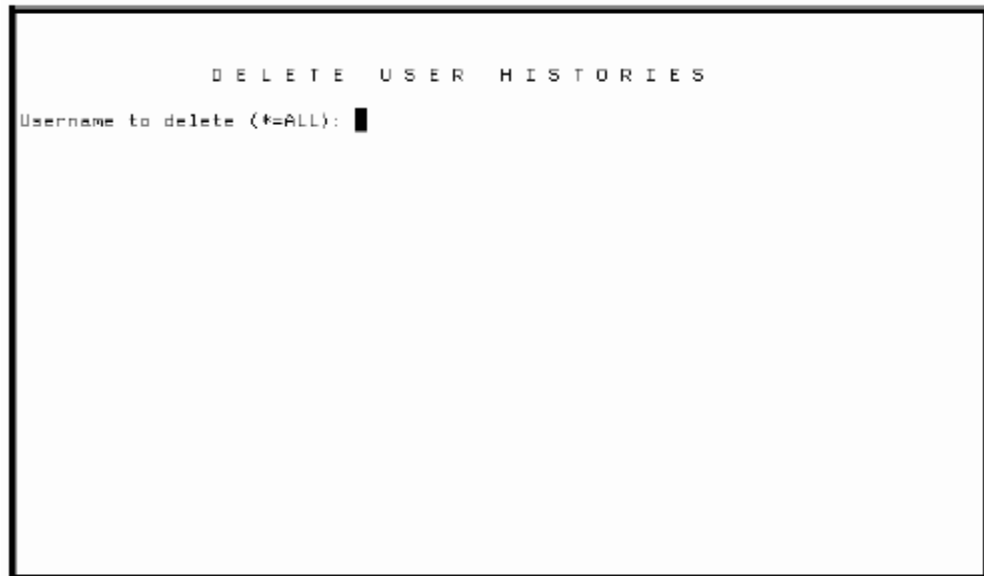

CXD-3190A

Delete User Histories Screen Diagram

Figure 4–4 illustrates the Delete User Histories screen.

Procedure

Perform the steps described in Table 4–12 to use the Delete User Histories menu option.

Requirement:

This screen requires input. Pressing Return without entering any data displays the prompt "Press Return to continue". Pressing the Return key again brings you back to the main menu without submitting the batch job.

Table 4–12 Delete User Histories

Step	System Prompt	Action
1	-	Enter 9 from the Operator Menu and press Return. <u>Result:</u> The software displays the Delete User Histories screen.
2	Username to delete (*=ALL):	<ul style="list-style-type: none"> • <u>IF</u> you want to delete all user names, <u>THEN</u> enter * and press Return, • <u>ELSE</u> enter the user name and press Return.
3	Delete BEFORE date (*=ALL):	Enter the date to delete the user history files by and press Return.

SLS Catalog Safety and Maintenance

4.4 Data Safety with the VMS Backup Utility

Table 4–12 Delete User Histories

Step	System Prompt	Action
4	Volume ID (* = ALL):	Enter the Volume ID for which you want to delete user histories and press Return. <u>Result:</u> The SLS software enters this job in the batch queue. The history files are deleted when the batch job is completed. <u>Note:</u> Records for the user/volume in the system history files are not deleted.

4.4 Data Safety with the VMS Backup Utility

This section describes how to implement an SLS data safety policy using the VMS Backup utility.

Important Considerations

Consider the following items when implementing a data safety policy using the VMS Backup utility:

- Location of the volume database and SLS history files
- The amount of time invested for save operations compared to the amount of time needed for restore operations

Locations for the volume database and SLS history files:

To ensure the safety of the volume database and of the system history files, place the volume database on a different device than the SLS system history files.

Save operation recommendations:

- Perform a daily save operation of the volume and magazine databases during a period of stability. The exposure to data loss is then limited to one day.
- Perform a save operation of the SLS system history files after they are updated.

Time to restore:

The frequency of save operations has the following effect on the amount of time needed to restore data:

- If you decrease the frequency of save operations, you increase the time to restore data.
- If you increase the frequency of save operations, you decrease the time to restore data.

4.4.1 Volume and Magazine Database Device Failure

The procedure in Table 4–13 describes how to restore data in the event the device that contains the volume and magazine database fails. Completing this procedure returns the volume and magazine databases to their status at the time of the last save operation.

Table 4–13 How to Restore the Volume or Magazine Database from a BACKUP Copy

Step	Action
1	Shut down the SLS software.

Table 4–13 How to Restore the Volume or Magazine Database from a BACKUP Copy

Step	Action
2	Select another device and restore the following files from the last image backup operation: <ul style="list-style-type: none"> • SLS\$ROOT:[PRIMAST]*.* • SLS\$ROOT:[PARAMS]*.* <p><u>Note:</u> Make a note of the device name where these files are located for later use in this procedure.</p>
3	Perform restore operations from all subsequent incremental backup operations of SLS\$ROOT:[PRIMAST] and SLS\$ROOT:[PARAMS].
4	Edit the SYSS\$MANAGER:TAPESTART.COM file to change the assignment of PRIMAST to the device noted in Step 2.
5	Start SLS software.

4.4.2 SLS System History File Device Failure

The procedure in Table 4–14 describes how to restore data if the device that contains the SLS system history files fails. Completing this procedure returns the SLS system history files to their status at the time of the last save operation.

Table 4–14 How to Restore the SLS System History Files from a BACKUP Copy

Step	Action
1	Shut down the SLS software.
2	Select another device and perform a full disk restore of the SLS system history files from the last image backup operation. <p><u>Note:</u> Make a note of this device name for later use in this procedure.</p>
3	Perform restore operations from all subsequent incremental backup operations of the SLS system history files.
4	Edit the SYSS\$MANAGER:TAPESTART.COM file to change the assignment of HISDIR_n to the device noted in Step 2.
5	Start SLS software.
6	To update the SLS system history files, obtain a list of volumes allocated since the last backup operation of the SLS history files. Report volumes allocated in that interval by entering the command: <pre style="margin-left: 40px;">\$ STORAGE REPORT VOLUME ALLOCATED_DATE=yesterday</pre>
7	For each volume on the report, execute the SYSOLDTAPE command to update the SLS system history files.

SLS Catalog Safety and Maintenance

4.4 Data Safety with the VMS Backup Utility

4.4.3 Manually Updating the SLS System History Files

In the event of a device failure that occurs between the time of the system backup operation or a standby archive operation, and the automatic SLS system history file update, you can manually update the SLS system history files by following the steps in Table 4–15.

1-30 SLS Catalog Safety and Maintenance

Table 4–15 How to Manually Update SLS System History Files

Step	Action
1	Log in to an account on the SLS server node in which you can grant: <ul style="list-style-type: none"> The CMKRNL privilege Read and write access to the system authorization file
2	Obtain a list of all volumes allocated since the last SLS system history file update by entering the command: <pre>\$ STORAGE REPORT VOLUME ALLOCATED_DATE=date_of_last_update</pre>
3	Enable your terminal as an operator console so you can reply to SLS software requests with OPCOM by entering the command: <pre>\$ REPLY/ENABLE</pre>
4	Submit the command procedure SLS\$SYSTEM:SYSOLDTAPE.COM under the SLS account by entering the command: <pre>\$ SUBMIT/USER=SLS/PARAM=(history_set,volume_id,"*") -</pre> <pre>\$ _ SLS\$SYSTEM:SYSOLDTAPE.COM</pre> <p><u>Where:</u> <i>history_set</i> is the name of the SLS system history file set to update <i>volume_id</i> is the Volume ID of the first volume "*" indicates all save sets on the volume</p>
5	SLS software will issue an OPCOM request to mount the first volume. <ul style="list-style-type: none"> Mount the FIRST volume. Reply to the OPCOM message by entering the command: <pre>\$ REPLY/TO=n</pre>
6	SLS software will issue two OPCOM requests. The second request includes a list of options. Reply to this OPCOM message by using the CONT option by entering the command: <pre>\$ REPLY/TO=n CONT</pre>
7	Continue with Steps 5 and 6 selecting the volumes in sequence until all volumes have been processed.
8	After all volumes have been processed, SLS software submits a batch job to perform the actual SLS system history file update. Check for the name of the job by entering the command: <pre>\$ SBUPDT_history_volume</pre> <p><u>Where:</u> <i>history</i> is the SLS system history name <i>volume</i> is the name of the first volume to be updated</p>

4.5 Data Safety with VAX RMS Journaling and the VMS Backup Utility

This section describes how to implement a SLS data safety policy with VAX RMS Journaling software and the VMS Backup utility.

Important Considerations

Consider the following items when implementing a data safety policy using VAX RMS Journaling software and the VMS Backup utility:

- The location of the journal file and the volume and magazine databases
- More frequent save operations reduce the size of the journal file

Journal file location:

To avoid loss of all SLS data in the event of a device failure, the journal file should be located on a different device than the volume and magazine databases.

Journal size:

The frequency of save operations on the SLS data effects the size of the journal as follows:

- If you decrease the frequency of save operations on the volume and magazine databases, you increase the size of the journal file.
- If you increase the frequency of save operations on the volume and magazine databases, you decrease the size of the journal file.

4.5.1 Implementing Data Safety with the VMS Backup Utility and VAX RMS Journaling

The procedure in Table 4–16 describes how to supplement the VMS Backup utility with VAX RMS Journaling to ensure SLS data safety.

Table 4–16 How to Implement a Data Safety Policy Using the VMS Backup Utility with VAX RMS Journaling

Step	Action
1	Establish the journal file on a different device than the volume and magazine databases. <u>Recommendation:</u> Journal activity on SLS\$MASTER:TAPEMAST.DAT.
2	Determine the frequency of image and incremental backup operations you need to make on the volume and magazine databases.
3	Perform an image backup operation of the volume and magazine databases.
4	Enable VAX RMS Journaling on the volume and magazine databases.
5	For each incremental backup operation of the volume and magazine databases, restart the journal.
6	When the image backup operation period has passed, proceed again with Step 3.

SLS Catalog Safety and Maintenance

4.6 Data Safety with VAX Volume Shadowing Software

4.5.2 VAX RMS Journal Device Failure

The procedure in Table 4–17 describes how to maintain SLS data safety if the VAX RMS Journal device fails. Completing this procedure ensures continuous safety of the volume and magazine databases.

Table 4–17 How to Respond to a VAX RMS Journal Device Failure

Step	Action
1	Immediately shut down SLS software to halt activity on the volume and magazine databases.
2	Perform an image backup operation of SL\$MASTER:TAPEMAST.DAT.
3	Redirect the VAX RMS Journal to another device.
4	Restart the SLS software.

4.6 Data Safety with VAX Volume Shadowing Software

With VAX Volume Shadowing software, you create a virtual device with two or more physical devices to protect against data loss. This requires an additional device, but provides for fewer service interruptions.

Establish a VAX Volume Shadow set for the device that will store the volume database, magazine database, and SLS system history files.

Recommendation:

Although VAX Volume Shadowing provides a higher level of data security, it is recommended that you still maintain a data safety policy for data maintained on a VAX Volume Shadow set.

More information:

For more information, refer to the *VAX Volume Shadowing Manual*.

SLS Catalog Safety and Maintenance
4.6 Data Safety with VAX Volume Shadowing Software

Configuring SLS System Backup Operations

This chapter explains how to configure various symbols for your system backup operations. It includes the following topics:

- A description of system backup operations
- An introduction to system backup command files
- Information about defining scheduling parameters for system backup operations
- Information about defining the system backup operation
- A list of files created during a system backup operation

5.1 SLS System Backup Operations

SLS system backup operations save copies of disk files onto tape or optical cartridges. In the event of lost data, these saved copies can be used to restore the original data.

System backup operations differ from user backup operations because system backup operations can save or restore any file, while user backup operations can only save or restore files owned by the user.

SLS system backup operations are invoked by system backup command files. One system backup operation corresponds with one system backup command file.

SLS system backup operations are usually done in batch mode and can be executed:

- Manually
- Automatically to run at a specific time on a repetitive interval

SLS Software Features for System Backup Operations

SLS software provides the following system backup operation features:

- A menu interface to the VMS Backup utility
- A method of invoking manual system backup operations to satisfy random needs
- The scheduling of system backup operations to execute
- automatically at a specific time on a repetitive schedule
- A method of generating SLS system history files. History files contain information about the save sets where copied data is stored. This information can later be used to find the save set and restore the copied data.

Configuring SLS System Backup Operations

5.2 System Backup Command Files

5.2 System Backup Command Files

This section describes the requirements, conventions, and functional considerations that affect the use of system backup command files.

Requirements:

The system backup command file must:

- Properly qualify the VMS Backup utility operation
- Have a unique name ending with "_SBK.COM."

Example:

filename_SBK.COM

- Be stored in the SLSS\$SYSBAK directory

Conventions:

System backup command files are typically named to reflect their role in your overall backup policy.

Example file names:

The following example file names would be used to identify the system backup files for daily incremental backup operations and a weekly backup operations that occurs on Sunday. No system backup operation is required for Saturday.

MONDAY_INCREMENTAL_SBK.COM

TUESDAY_INCREMENTAL_SBK.COM

WEDNESDAY_INCREMENTAL_SBK.COM

THURSDAY_INCREMENTAL_SBK.COM

FRIDAY_INCREMENTAL_SBK.COM

SUNDAY_IMAGE_SBK.COM

Considerations:

With the system backup command file, SLS software enables you to customize a wide range of aspects for any system backup operation. All these aspects have been organized into groups of symbols. They are:

- System backup control, including automatic scheduling
- System backup type
- Volume characteristics
- Operator intervention
- Resource allocation
- Volume disposition
- Device control
- Status and information reporting

5.2.1 Creating SLS System Backup Command Files

The following methods enable you to create system backup command files:

- Use your favorite text editor to copy and then modify the SYSBAK.TEMPLATE file.

The SLSSYSBAK:SYSBAK.TEMPLATE file is a template that contains DCL symbols. Assignments made to these symbols control a system backup operation.

- Use the SLS Operator Menu option for Manual System Backup. This option executes the SLSSYSTEM:DO_A_BACKUP.COM file. This file leads you through an interactive dialog to build a system backup command file. See <REFER NCE>(manual_system_backup) for instructions about using this feature.

5.2.2 System Backup Operations Using SYSBAK.TEMPLATE

The SYSBAK.TEMPLATE file is your primary interface for setting up and executing system backup operations. The remainder of the discussion about system backup operations in this manual refers only to this system backup command file.

SYSBAK.TEMPLATE

Example 1-1 shows you the file named SYSBAK.TEMPLATE. You can copy this file and edit the copied file to create a system backup command file.

Note

Do not edit the SYSBAK.TEMPLATE file. Copy SYSBAK.TEMPLATE to another file name and edit the new file.

Example 5–1 SYSBAK.TEMPLATE

```
$!  
$! SYSBAK.TEMPLATE SLS V2.2  
  
$!  
  
$!  
  
$! COPYRIGHT (c) Helett-Packard Development Company, L.P 2004  
  
$!  
$!  
  
$! This file contains parameters to run a system backup.  
  
$!  
$! -----  
  
$! Automatic Scheduling Parameters  
  
$!  
$! DAYS_1 :==  
$! TIME_1 :==  
$! NODE_1 :==
```

Configuring SLS System Backup Operations

5.2 System Backup Command Files

```
$!  
  
$! DAYS_2 :==  
  
$! TIME_2 :==  
  
$! NODE_2 :==  
  
$!  
  
$! DAYS_3 :==  
  
$! TIME_3 :==  
  
$! NODE_3 :==  
  
$!  
  
$! -----  
  
$! Disk File Selection Parameters  
  
$!  
  
$ FILES_1 :== SYS$SYSDISK:  
  
$!  
  
$! Backup Type Definition Parameter for this file only  
  
$!  
  
$! QUALIFIERS_1 :==  
  
$!  
  
$ PROGRESS == 1000  
  
$!  
  
$! -----  
  
$! Default Backup Type Definition Parameter  
  
$!  
  
$ QUALIFIERS :== /RECO/IGNO=INTE/VERI  
  
$!  
  
$! -----  
  
$! Backup privileges  
  
$!  
  
$ PRIVS :== BYPASS  
  
$!  
  
$! -----
```

Configuring SLS System Backup Operations 5.2 System Backup Command Files

```
$! Saveset Name Generation Parameter

$!

$ SAVESET_GEN == "F$EXTRACT(0,15,DO_DISK) + ".BAK"

$!

$! -----

$! Online History Parameters

$!

$ HISTORY_SET ::= DAILY

$ SBUPDT_Q ::= SYS$BATCH

$!

$! -----

$! Listing File Parameters

$!

$ LISTING_GEN == ""SLS$SYSBK:" + F$EXTRACT(0,15,P1) + NODE +
F$EXTRACT(0,15,DO_DISK)"

$

$ FULL ::= 0

$ PRINT_Q ::= SYS$PRINT ! /DELE

$!

$! -----

$! Reel Selection Parameters

$!

$ MEDIA_TYPE ::= 9TRACK

$ PREALLOC == 0

$ AUTOSEL == 1

$ TAPE_POOL ::= 'HISTORY_SET'

$ REEL_SIZE == 2400

$ NOTES ::= SYSTEM BACKUP

$ CONTINUE ::=

$ CONTLOADOPT == 2

$!

$! -----
```

```
$! Reel Retention Parameters

$!

$ SCRATCH_DAYS ::= 60

$ OFFSITE_DATE ::=

$ ONSITE_DATE ::=

$!

$! -----

$! Reel / Saveset Protection Parameter

$!

$ PROTECTION ::= S:RW,O:RW,G:R,W:R

$!

$! -----

$! Tape Drive Selection Parameters

$!

$ N_DRIVES == 1

$ DENSITY ::= 6250

$ DRIVE_TYPE ::=

$!

$! -----

$! Volume Mount Parameters

$!

$ @SLS$DATAC:MNTDEF MNT$M_READCHECK MNT$M_MESSAGE -
MNT$M_WRITECHECK MNT$M_TAPE_DATA_WRITE

$ MNTFLAGS == MNT$M_MESSAGE .OR. MNT$M_TAPE_DATA_WRITE

$

$ QUICKLOAD == 0

$!

$! -----

$! Status Mail Parameter

$!

$ STATUS_MAIL ::=
```

Configuring SLS System Backup Operations 5.2 System Backup Command Files

```
$!  
  
$! -----  
-----  
  
$! Backup Job Chain Parameter  
  
$!  
  
$ NEXT_JOB :==  
  
$!  
  
$! -----  
  
$! User Message Parameter  
  
$!  
  
$ REPLY_MSG := REQUEST/TO=(TAPES)  
  
$!  
  
$! -----  
  
$! Tape Label Parameter  
  
$!  
  
$ TAPE_LABELS == 2  
  
$!  
  
$! -----  
  
$! Batch Log File Parameter  
  
$!  
  
$ LOG_FILE := !/[NO]PRINT/[NO]KEEP  
  
$!  
  
$! -----  
  
$! Summary File Generation  
  
$!  
  
$ SUMMARY_FILE == 2  
  
$!  
  
$! -----  
  
$! Pre- & Post- Processing DCL Commands  
  
$!  
  
$! PRE_PROCESS_FIRST :==  
  
$! PRE_PROCESS_EACH :==
```

Configuring SLS System Backup Operations

5.2 System Backup Command Files

```
$! POST_PROCESS_EACH :==  
  
$! POST_PROCESS_LAST :==  
  
$EXIT
```

For detailed instructions about creating system backup command files for system backup operations, see Section A.1.

5.2.3 Executing System Backup Operations

This section describes the types of methods that system backup operations are executed:

- Manually started
- Automatically scheduled

These descriptions only provide an overall understanding. For more detailed information about automatic scheduling, refer to Section 5.3.1.

5.2.3.1 Running Manual Backup Operations

For a manual system backup operation, define the symbols in the system backup command file to reflect the characteristics of your required system backup operation. You are not required to make assignments to the scheduling symbols (DAYS_n, TIME_n, and NODE_n) for a manually executed system backup command file.

Enter the following command to manually execute a system backup command file:

```
$ STORAGE STARTUP SYSTEM_BACKUP filename_SBK.COM
```

Note

This command does not require the "_SBK.COM" portion of the file name. The command will automatically append the string "_SBK.COM" to the filename if it is not provided.

5.2.3.2 Running Automatically Scheduled Backup Operations

There are three symbols that control the automatic scheduling of system backup operations:

- DAYS_n
- TIME_n
- NODE_n

Making assignments to each of these symbols defines the day, time, and node on which the system backup operation will run. Make more than one set of scheduling assignments to execute the same operation on different days.

How the automatic schedule works:

The following table describes how the automatically scheduled system backup operation occurs.

Stage	Action
1.	Each night at midnight, SLS\$TAPMGRQ triggers a process that examines every system backup command file located in the directory SLSSYSBAK.

Stage	Action
2.	<p>The scheduling symbols in each system backup command file are read in sequence from the top.</p> <ul style="list-style-type: none">• IF none of the days specified is the current day, OR IF the current day is a holiday, THEN the command file is not processed.• IF the day specified is the current day, <p>AND the corresponding NODE_n symbol points to the node on which the SLS\$TAPMGRRQ process is running, AND the job has not already been queued today, THEN the command file is queued for execution.</p>
3	<p>At the specified time, the system backup operation is executed.</p>

5.3 Preparing for System Backup Operations

Before you can execute any SLS system backup operations, you must prepare SLS software:

- Plan for maintaining SLS system history files (<REFERENCE>(sls_history_files)).
- Consider holiday impact on operator staff schedules.
- Plan for unattended system backup operations (if you have the appropriate equipment) that can execute without operator intervention.

Consider your SLS system backup policy when making assignments to the symbols in system backup command files. In particular, you must meet certain requirements and conventions. These are described in the following sections.

To control your SLS system backup operations, you must consider:

- Manual submission or automatic scheduling
- Skipping the system backup operations on holidays
- Any processing that must take place within the context of your system backup operation
- Any processing that must take place after the system backup operation completes
- The ability to restore the saved data

5.3.1 How to Define Automatic Scheduling Days

SLS software provides for automatic scheduling of various features such as system backup operations and volume usage reporting. This section describes the syntax in further detail and provides examples.

5.3.1.1 Symbols for Automatic Scheduling

You may specify as many DAYS_n, TIME_n and NODE_n triplets as you need for any system backup operation. SLS software uses the triplet of the first DAYS_n symbol that matches the current day.

Rule:

You may specify as many triplets as needed, but they must be numbered sequentially, beginning at the number one.

5.3.1.2 Specifying a Day of the Week

To specify a day of the week for automatic scheduling, use the name of the day in the assignment.

Configuring SLS System Backup Operations

5.3 Preparing for System Backup Operations

Allowable assignments:

For the day of the week, use:

- MONDAY
- TUESDAY
- WEDNESDAY
- THURSDAY
- FRIDAY
- SATURDAY
- SUNDAY

Restriction:

Do not abbreviate the name of the day.

Example: Volume usage report

To automatically schedule a volume usage report for each Tuesday, assign:

```
$ DAYS := TUESDAY
```

Multiple assignments:

Multiple assignments are allowed when separated by commas.

Example: System backup operation:

To automatically schedule a system backup operation for Monday and Friday, assign to the DAYS_n symbol:

```
$ DAYS_1 := MONDAY,FRIDAY
```

5.3.1.3 Specifying a Day Offset into a Month

There might be a need to automatically schedule a process for the third day of the month, or two days before the end of the month.

Format:

The format of this assignment is:

MONTH direction offset

Where:

- direction is a:
 - Plus sign (+) to indicate days from the beginning of the month
 - Minus sign (-) to indicate days from the end of the month
- offset is the number of days

Example: From the beginning of the month:

If you want to schedule generation of a volume usage report for the fourth day of the month, assign:

```
$ DAYS := MONTH + 4
```

Example: From the end of the month:

Configuring SLS System Backup Operations

5.3 Preparing for System Backup Operations

If you want to schedule a system backup operation for the last day of the month, assign:

```
$ DAYS_1 ::= MONTH - 1
```

5.3.1.4 Specifying a Week Offset into a Month

There might be a need to automatically schedule a process for the second Sunday of the month, or the next to last Tuesday of the month.

Format

The format of this assignment is:

MONTH direction week_offset * day_of_week

Where:

- direction is a:
 - Plus sign (+) to indicate days from the beginning of the month
 - Minus sign (-) to indicate days from the end of the month
- week_offset is the nth week occurrence
- day_of_week is any day of the week

Week Offset Assignments

Example: From the beginning of the month:

If you want to schedule generation of a volume usage report for the second Sunday of the month, assign:

```
$ DAYS ::= MONTH + 2 * SUNDAY
```

Example: From the end of the month:

If you want to schedule a system backup operation for the next to last Thursday of the month, assign:

```
$ DAYS_1 ::= MONTH - 2 * THURSDAY
```

Day Offset from a Week Offset

Example: Day offset from a week offset:

If you want to schedule a system backup operation or generation of a volume report on the day before the third Saturday, or two days after the first Wednesday, you can add a day offset to the week offset assignment described in Week Offset Assignments.

Example: Specify days before:

If you want schedule a system backup operation two days after the first Wednesday, assign:

```
$ DAYS_1 ::= MONTH + 1 * WEDNESDAY + 2
```

Example: Specify days after:

If you want to schedule generation of a volume report on the day before the third Saturday, assign:

```
$ DAYS ::= MONTH + 3 * SATURDAY - 1
```

5.3.1.5 Specifying the Days to Run System Backup Operations

Examine Table 5–1 to determine how to specify the days to run system backup operations.

Configuring SLS System Backup Operations

5.3 Preparing for System Backup Operations

Table 5–1 How to specify the days to run system backup operations

IF you want to schedule a system backup operation for...	THEN assign...
Any day	<p>The name of the day for a single day or days separated by commas <u>Example 1:</u> Running the backup on Monday.</p> <pre data-bbox="756 541 1000 562">\$ DAYS_1 ::= MONDAY</pre> <p><u>Example 2:</u> Running the backup on both days of the weekend.</p> <pre data-bbox="756 667 1114 688">\$ DAYS_1 ::= SATURDAY, SUNDAY</pre>
A particular day of the month	<p>The keyword MONTH and plus or minus the number of the day <u>Example 1:</u> Running the system backup operation on the third day of the month.</p> <pre data-bbox="756 810 1032 831">\$ DAYS_1 ::= MONTH + 3</pre> <p><u>Example 2:</u> Running the system backup operation on the last day of the month.</p> <pre data-bbox="756 936 1032 957">\$ DAYS_1 ::= MONTH - 1</pre>
The nth occurrence of a particular day in a month	<p>The name of the month plus or minus the number of weeks and the particular day <u>Example 1:</u> Running the system backup operation on the third Saturday of the month.</p> <pre data-bbox="756 1104 1179 1125">\$ DAYS_1 ::= MONTH + 3 * SATURDAY</pre> <p><u>Example 2:</u> Running the system backup operation on the last Sunday of the month.</p> <pre data-bbox="756 1230 1154 1251">\$ DAYS_1 ::= MONTH - 1 * SUNDAY</pre>
A day related to the nth occurrence of a particular day in a month	<p>The name of the month plus or minus the number of weeks, particular day, and the day <u>Example 1:</u> Running the system backup operation on the day after the fourth Monday of the month (either the fourth Tuesday of the current month or first Tuesday of the following month).</p> <pre data-bbox="756 1453 1203 1474">\$ DAYS_1 ::= MONTH + 4 * MONDAY + 1</pre> <p><u>Example 2:</u> Running the system backup operation three days before the second Sunday of the month.</p> <pre data-bbox="756 1600 1203 1621">\$ DAYS_1 ::= MONTH + 2 * SUNDAY - 3</pre>

More information:

Refer to Section 5.3.1 for more detailed information on specifying days for automatic scheduling.

5.3.1.6 Specifying the Time of Day to Run System Backup Operations

Assign a time value to the following symbol using hours and minutes:

Example:

To run the backup at 4:00 p.m.:

```
$ TIME_1 ::= 16:00
```

Additionally, you may assign any allowable qualifiers of the DCL SUBMIT command.

5.3.1.7 Overriding the Default Queue with the Time Definition

The default queue is assigned to the BATN symbol in the SYSS\$MANAGER:TAPESTART.COM file. To override this

assignment, specify the queue name with the /QUEUE qualifier in this file.

Example:

To run the backup at 1:00 a.m. on the SYSS\$BATCH queue:

```
$ TIME_2 ::= 01:00/QUEUE=SYSS$BATCH
```

5.3.1.8 Specifying the Node Executing the DCL SUBMIT Command

Assign to the NODE_n symbol the node name of the node that will execute the DCL SUBMIT command. This node does not have to be the node that actually executes the backup job.

Specifying this node on an OpenVMSccluster system:

Assign to the NODE_n symbol one of the nodes running the SLS server.

For a specific OpenVMSccluster system node:

To ensure the job actually executes on the node assigned to NODE_n you must:

- Include a /QUEUE qualifier with the TIME_n symbol that indicates a queue on the node in the OpenVMSccluster system, OR
- Do not include the /QUEUE qualifier with the TIME_n symbol and define the queue with the BATN symbol

Specifying more than one node:

To specify more than one node for a NODE_n symbol, the job queued by one of those nodes is picked at random.

You must:

Separate the node names with a comma	OR	Assign the OpenVMSccluster system queue to the BATN symbol in the SYSS\$MANGER:TAP-ESTART.COM file
--------------------------------------	----	--

Note

Avoid more than one node running the job on the same day by specifying an OpenVM-Sccluster system queue with the TIME_n /QUEUE qualifier.

Configuring SLS System Backup Operations

5.3 Preparing for System Backup Operations

Specifying this node on a standalone system:

Assign the NODE_n symbol the name of the processor. If the processor is not part a network, then leave the NODE_n symbol blank.

5.3.1.9 Example: Automatic Scheduling Selection

The following example shows triplets defined for performing backups at one of two different times:

```
$ DAYS_1 ::= MONDAY

$ TIME_1 ::= 23:00

$ NODE_1 ::= MARS

$!

$!

$ DAYS_2 ::= MONTH + 1

$ TIME_2 ::= 10:00

$ NODE_2 ::= MARS
```

In this example:

- When the current day is Monday, then the system backup operation is submitted on MARS at 23:00.
- When the current day is not Monday, but is the first day of the month, then the system backup operation is submitted at 10:00 on MARS.

5.3.1.10 Skipping an Automatically Scheduled System Backup Operation

The following example shows how to skip an automatically scheduled backup operation. Assign an automatic scheduling triplet:

```
$ DAYS_1 ::= MONTH -1

$ TIME_1 ::=

$ NODE_1 ::=

$!

$!

$ DAYS_2 ::= WEDNESDAY

$ DAYS_2 ::= 17:00

$ NODE_2 ::= VOLKS
```

In this example:

- If the current day is the last day of the month, then the system backup operation is not performed as specified in the *_SBK.COM file.
- If the current day is not the last day of the month, but is Wednesday, then the system backup operation is submitted at 17:00 on node VOLKS.

5.3.2 Skipping Automatic System Backup Operations on Holidays

Automatic system backup operations are usually skipped on holidays because operators are not available to service SLS software mount requests. SLS software does not automatically reschedule the system backup operations for another day.

The SLSPARAMS:HOLIDAYS.DAT file contains holiday definitions. Edit this file to include the holidays observed by your site. SLS uses the latest version of HOLIDAYS.DAT file.

5.3.2.1 HOLIDAYS.DAT Record Format

The format for each record in HOLIDAYS.DAT file is:

dd-mmm-yyyy,xxxxxxxxxx

Where:

dd-is the day

mmm-is the first three letters of the month

yyyy-is the year

xxxxxxxx-is the name of the holiday

5.3.2.2 Example: HOLIDAYS.DAT File

The following example shows the contents of a HOLIDAYS.DAT file for the year 1991.

04-JUL-1991,Independence Day

02-SEP-1991,Labor Day

28-NOV-1991,Thanksgiving

25-DEC-1991,Christmas

5.3.3 Preprocessing and Post-Processing Operations

Sometimes it is necessary to shut down an application before saving its data. The application must then be restarted after the save operation is complete. You might also have a need to run your own check on a backup operation after completion.

Such pre- and post-processing operations can be automatically enabled in the context of a system backup operation. The symbols for pre- and post-processing are:

- PRE_PROCESS_FIRST
- PRE_PROCESS_EACH
- POST_PROCESS_EACH
- POST_PROCESS_LAST

Rule:

Each symbol assignment must execute a DCL command file. That is, it must begin with an "@" sign and include a command file name.

5.3.3.1 Execution Sequence for Preprocessing and Post-Processing Symbols

Table 5-2 shows the execution sequence of the preprocessing and post-processing symbols and shows the corresponding symbols.

Configuring SLS System Backup Operations

5.3 Preparing for System Backup Operations

Table 5–2 Execution Sequence for Pre- and Post-Processing Symbols

Command files are executed...	With this symbol...
Once at the start of the entire backup operation	\$ PRE_PROCESS_FIRST
For each FILES_n symbol defined	\$ PRE_PROCESS_EACH
For each FILES_n symbol defined upon backup operation completion	\$POST_PROCESS_EACH
Once after the entire backup operation has completed	\$ POST_PROCESS_LAST

5.3.3.2 Symbols Enabled for Preprocessing and Post-Processing

Because pre- and post-processing operations are performed in the context of the system backup operation, certain symbols are available for the processes.

Table 5–3 lists the symbols that are defined and available for pre- and post-processing system backup operations and a description of the assignments.

Configuring SLS System Backup Operations

5.3 Preparing for System Backup Operations

Table 5–3 Symbols Enabled for Pre- and Post-Processing

Symbol	Description
DISK	Name of the backed up disk
FILES	Names of the backed up files
NODE	Name of the node
FIRST	First volume used
HISTORY	Name of the intermediate SLS system history file
LAST	Name of the last volume used
LISTING	Name of listing file
N_REELS	Number of volumes used Note: This symbol is functional only in a POST_PROCESS_EACH assignment and with a SUMMARY_FILE assignment that is not zero.
P1	Name of the *_SBK.COM file
P2	Index 1 through n of FILES_n being run Note: This symbol is functional only in PRE_PROCESS_EACH and POST_PROCESS_EACH assignments.
P3	The disk being backed up (translation of FILES_n) Note: This symbol is functional only in PRE_PROCESS_EACH and POST_PROCESS_EACH assignments.
SAVESET	Name of the save set written
STARTED	Date and time the backup operation started
STATUS	BACKUP exit status
STOPPED	Date and time the backup operation ended
SUMFN	Name of the summary file
All symbols in this *_SBK.COM file	_____

5.3.3.3 Executing Another SBK Batch Job After the Backup Operation

The NEXT_JOB symbol is useful to perform an identical save operation of the disk or disks saved by the current job, or to execute a second batch job for another drive or set of drives.

Assign to the NEXT_JOB symbol the name of a batch job to be submitted. Qualifiers to the DCL SUBMIT command (such as /QUEUE) are allowed.

Example:

If you want to execute the job named INCREMENTAL immediately after this job, assign the following:

```
$ NEXT_JOB ::= INCREMENTAL_SBK
```

Configuring SLS System Backup Operations

5.4 Defining the SLS System Backup Operation

5.4 Defining the SLS System Backup Operation

The type of SLS system backup operation is determined by the assignments that you make to the symbols in your SLS system backup command file (*_SBK.COM).

5.4.1 The VMS BACKUP Command

BACKUP command:

The system backup command file (*_SBK.COM) includes symbols that correspond to specific segments of a VMS BACKUP command.

```
$ BACKUP files_n /qualifiers /mntflags -
```

```
$_ saveset_gen /protection=protection
```

Where:

files_n	are the files to be saved
/qualifiers	are the VMS BACKUP qualifiers
/mntflags	are the additional qualifiers
saveset_gen	is the name of the BACKUP save set
/protection	is the protection given the save set and volume

5.4.1.1 Assignments to FILES_n

To select the files to be saved, assign the file name or disk name to the FILES_n symbol. To make the correct assignment, follow these rules:

- FILES_n symbols are sequentially numbered beginning with the number one, continuing with the number two, and so on.
- The numbers cannot contain leading zeros.
- The sequence cannot skip a number.
- The trailing colon must be included after the device name in each assignment.
- You may define as many FILES_n symbols as you need.

For an image backup operation:

Specify only the device name. The contents of the entire disk will be saved.

5.4.1.2 Assignments to QUALIFIERS and QUALIFIERS_n

The QUALIFIERS or QUALIFIERS_n symbol assignments are the same assignments used with the DCL BACKUP command and correspond to the FILES_n symbol:

- QUALIFIERS

The default BACKUP qualifiers assigned to FILES_n.

Restriction:

The QUALIFIERS symbol should not be changed in a system backup operation's preprocessing procedures.

Configuring SLS System Backup Operations

5.4 Defining the SLS System Backup Opera-

Example:

```
$ FILES_1 ::= DISK$USERDATA:  
  
$ FILES_2 ::= DISK$TESTDATA:  
  
$ QUALIFIERS ::= /IMAGE/VERIFY
```

- **QUALIFIERS_n**

The BACKUP qualifiers associated with a corresponding FILES_n, where "n" is the same value.

Example:

```
$ FILES_1 ::= DISK$USERDATA:  
  
$ QUALIFIERS_1 ::= /IMAGE/VERIFY/RECORD  
  
$ FILES_2 ::= DISK$TESTDATA:  
  
$ QUALIFIERS_2 ::= /IMAGE/VERIFY
```

Note

**The assignments in QUALIFIERS_n overrides the assignments in QUALIFIERS.
They are not appended together.**

Configuring SLS System Backup Operations

5.4 Defining the SLS System Backup Operation

Deciding When to Use QUALIFIERS or QUALIFIERS_n:

Table 5–4 describes deciding when to use either QUALIFIERS or the QUALIFIERS_n symbols.

Table 5–4 When to use QUALIFIERS or QUALIFIERS_n

IF the...	THEN specify...
System backup operation is a single disk or group of files for which you want to use the same VMS BACKUP qualifiers	<ol style="list-style-type: none"> 1. The disk or group of files to the FILES_1 symbol. 2. The VMS BACKUP qualifiers for all FILES_n to QUALIFIERS. <p><u>Example:</u> In this *_SBK.COM file, both DISK\$USERDATA and DISK\$TESTDATA use the same BACKUP qualifiers.</p> <pre> \$ FILES_1 ::= DISK\$USERDATA: \$ FILES_2 ::= DISK\$TESTDATA: \$ QUALIFIERS ::= /IMAGE/VERIFY </pre>
System backup operation is multiple disks or groups of files	<ol style="list-style-type: none"> 1. Each of the disks (or groups of files) to successive FILES_n symbols. 2. The BACKUP qualifiers that apply to more than one FILES_N to the QUALIFIERS symbol. 3. The BACKUP qualifiers that apply to a specific disk (or group of files) to the QUALIFIERS_n symbol that corresponds with the appropriate FILES_n. <p><u>Example:</u> This *_SBK.COM file specifies saving four disks. The first three disks require the same BACKUP qualifiers and the fourth disk requires different qualifiers. The assignments in the *_SBK.COM file would look like:</p> <pre> \$ FILES_1 ::= DISK\$USER1: \$ FILES_2 ::= DISK\$USER2: \$ FILES_3 ::= DISK\$USER3: \$ FILES_4 ::= DISK\$USER4: \$! \$! Default BACKUP qualifiers for DISK\$USER1, DISK\$USER2, and DISK\$USER3 \$ QUALIFIERS ::= /IMAGE/RECORD/VERIFY \$! \$! BACKUP qualifiers for DISK\$USER4 only \$ QUALIFIERS_4 ::= /IMAGE/RECORD/VERIFY/IGNORE=INTERLOC </pre>

Deciding When to Use OUTPUT_QUAL or OUTPUT_QUAL_n:

Table 6–5 describes deciding when to use either OUTPUT_QUAL or the OUTPUT_QUAL_n symbols.

Configuring SLS System Backup Operations

5.4 Defining the SLS System Backup Opera-

Table 5–5 When to use OUTPUT_QUAL or OUTPUT_QUAL_n

IF the . . .	THEN specify . . .
<p>System backup operation is a single disk or group of files for which you want to use the same VMS BACKUP qualifiers</p>	<ol style="list-style-type: none"> 1. The disk or group of files to the FILES_1 symbol. 2. The VMS BACKUP qualifiers for all FILES_n to OUTPUT_QUAL. <p>Example: In this *_SBK.COM file, both DISK\$USERDATA and DISK\$TESTDATA use the <u>same</u> BACKUP qualifiers.</p> <pre style="margin-left: 2em;">\$ FILES_1 ::= DISK\$USERDATA: \$ FILES_2 ::= DISK\$TESTDATA: \$ OUTPUT_QUAL ::= /GROUP=100</pre>
<p>System backup operation is multiple disks or groups of files</p>	<ol style="list-style-type: none"> 1. Each of the disks (or groups of files) to successive FILES_n symbols. 2. The BACKUP qualifiers that apply to more than one FILES_N to the QUALIFIERS symbol. 3. The BACKUP qualifiers that apply to a specific disk (or group of files) to the QUALIFIERS_n symbol that corresponds with the appropriate FILES_n. <p>Example: This *_SBK.COM file specifies saving four disks. The first three disks require the <u>same</u> BACKUP qualifiers and the fourth disk requires <u>different</u> qualifiers. The assignments in the *_SBK.COM file would look like:</p> <pre style="margin-left: 2em;">\$ FILES_1 ::= DISK\$USER1: \$ FILES_2 ::= DISK\$USER2: \$ FILES_3 ::= DISK\$USER3: \$ FILES_4 ::= DISK\$USER4: \$! \$! Default BACKUP qualifiers for DISK\$USER1, DISK\$USER2, and DISK\$USER3\$ QUALIFIERS ::= /IMAGE/RECORD/VERIFY \$ OUTPUT_QUAL ::= /GROUP=100 \$! BACKUP qualifiers for DISK\$USER4 only \$ QUALIFIERS_4 ::= /IMAGE/RECORD/VER- IFY/IGNORE=INTERLOCK \$ OUTPUT_QUAL_4 ::= /GROUP/BLOCK_SIZE=65535</pre>

Restriction: Qualifiers Not to Use

Do not use the following assignments in the QUALIFIERS or QUALIFIERS_n symbol:

- /REWIND
- /NOREWIND
- /LIST
- /FULL

Recommendation:

Remove the /MEDIA_FORMAT qualifier if media compaction and record blocking were previously enabled or disabled by assigning this qualifier. Enable the desired characteristic by using the DENSITY symbol.

Configuring SLS System Backup Operations

5.4 Defining the SLS System Backup Operation

If a volume is a cartridge loaded on a TA90 or TA90E tape drive, and if the volume's density field is either "COMP" or "NOCOMP," then the SLS software will automatically append the /MEDIA_FORMAT qualifier.

Recommended Assignments for the QUALIFIERS or QUALIFIERS_n Symbol:

Table 5–6 lists recommended assignments to the QUALIFIERS or QUALIFIERS_n symbol. These assignments are identified and briefly described, but are listed in no particular order.

Table 5–6 Recommended QUALIFIERS or QUALIFIERS_n Assignments

Use the QUALIFIER...	To...
/BLOCK_SIZE=n	Set the block size for data records in a BACKUP save set. Acceptable range for n is 2048 through 65,534. <u>Recommended block sizes:</u> <ul style="list-style-type: none"> • 24 KB for reel-to-reel tapes • 32 KB for TA90 • 64 KB for TA90 if you do not want to copy save sets. <u>Default block sizes:</u> If you do not use this qualifier, the default block sizes are: <ul style="list-style-type: none"> • Disk save set-32,356 bytes • Magnetic tape save set-8192 bytes
/IMAGE	Execute an image backup. <u>Caution:</u> Using this assignment causes SLS software to use ONLY the device specification in the FILES_n symbol, implicitly selecting all files. This could possibly increase your system backup operation time.
/FAST	Prescan all files.
/RECORD	Record the backup date in file headers. <u>Note:</u> This qualifier requires WRITE access to the files being backed up.
/IGNORE=INTERLOCKS	Back up files currently open for write by other applications on the system.
/IGNORE=NOBACKUP	Back up files that are marked as no backup.
/VERIFY	Verify the backup.
/DELETE	Delete files after backing them up.
/MOD-IFY/SINCE=BACKUP	Back up files modified since the last backup was done with the /RECORD qualifier.
/EXPIRED /BEFORE=TODAY	Back up files that expired before today. <u>Note:</u> Files without a defined expiration date are considered to have expired on 17-NOV-1858. Refer to 9.1.2 for more information on setting expiration_dates.

Examples of Defining Backup Types:

The following examples show how to specify the backup type.

Image backup:

Configuring SLS System Backup Operations

5.4 Defining the SLS System Backup Opera-

To perform an image backup (everything on the disk), record the backup date on the disk file headers, and to verify that the files were copied as specified, set the QUALIFIERS symbol as follows:

```
$ QUALIFIERS ::= /IMAGE/RECORD/VERIFY
```

Configuring SLS System Backup Operations

5.4 Defining the SLS System Backup Operation

Incremental backup:

To perform an incremental backup (a backup of all files that were modified since the last backup that used the /RECORD qualifier), set the QUALIFIERS symbol as follows:

```
$ QUALIFIERS := /MODIFY/SINCE=BACKUP/RECORD/VERIFY
```

5.4.1.3 Defining the Backup Privilege

The privileges assigned to the PRIVS symbol determine if SLS software can access files that are to be saved, regardless of the file's individual protection. This assignment is equivalent to a VMS privilege assignment that is necessary to run a system backup operation.

Default:

The default assignment is BYPASS. This allows SLS to bypass individual file protection and save or restore any files on the device.

Caution: READALL privilege:

Users with the READALL privilege have access to file headers which enables them to modify files.

5.4.1.4 Assignments to MNTFLAGS

Assignments to the MNTFLAGS symbol specify the MOUNT qualifiers to use for the system backup operation. More than one assignment may be specified as a logical OR operation on the allowable assignments.

Caution:

Do not modify @SLS\$DATAC:MNTDEF (located immediately before the MNTFLAGS symbol in the SYSBAK.TEMPLATE file.

5.4.1.5 Assigning Additional Mount Actions

Table 5–7 lists actions that can be enabled when the volume is mounted for the system backup operation, and the corresponding assignment for the MNTFLAGS symbol.

Note

A DCL .OR. can be used to specify multiple flags.

Table 5–7 Mount Action Symbol Assignments

IF you want to...	THEN assign...
Perform readcheck	\$ MNTFLAGS == MNT\$M_READCHECK
Place a message in the log for each volume mounted	\$ MNTFLAGS == MNT\$M_MESSAGE
Perform writecheck	\$ MNTFLAGS == MNT\$M_WRITECHECK
Enable the tape controller's write cache (if supported by _hardware)	\$ MNTFLAGS == MNT\$M_TAPE_DATA_WRITE

Note

Ensure that you understand the behavior enabled by assignments made to the MNT-FLAGS symbol. Some assignments may cause a longer time than necessary to complete a backup operation.

5.4.1.6 Save Set Name Symbol Descriptions

The string assignments made to the SAVESET_GEN symbol translates into the string used to generate save set names. The SAVESET_GEN symbol allows you to specify the format of the save set names that are written to tape.

The SLS software provides many symbol name string assignments that define the SAVESET_GEN symbol. They are grouped into the following classes:

1. File and device
2. Time and sequence
3. Any symbol assignment in the *_SBK.COM file

Table 5–8 lists and describes the symbol assignments for the SAVESET_GEN symbol, describing both the file and device assignments, as well as time and sequence assignments.

Configuring SLS System Backup Operations

5.4 Defining the SLS System Backup Operation

Table 5–8 Values for SAVESET_GEN

Type	Symbol Assignment	Generates a save set name representing the...
File and device	NODE	Node executing the backup operation
	DO_DISK	Device name (without the colon)
	DO_FILES	Parsed file specification
	HSTDIR	Device and directory where the SLS system history files are stored; this is defined only when the HISTORY_SET symbol has an assignment (is not null).
	TOPDIR	Top level directory name of DO_FILES (up to the first wildcard or subdirectory specified)
	FNAME	File name portion of DO_FILES
	FTYPE	File type portion of DO_FILES, without the leading "."
Time and sequence	P1	*_SBK.COM file name
	P2	Index 1...n of FILES_n being run (or null if a manual backup operation)
	DAY	Day of the week the backup is run, such as TUESDAY
	DAY3	Three-character day of the week, such as TUE
	DOM	Two-digit day of the month, such as 01, 02
	MONTH	Three-character month, such as JAN, FEB, MAR
	MONTHN	Two-digit number of month, such as 01, 02, 03

Restriction:

The VMS Backup utility writes only the first 17 characters of a save set name on a volume and only responds to that length on restore operations. The SLS software truncates any name longer than 17 characters using the following criteria, in the presented order, until the name is short enough:

- Use only the file name and file type specified.
- Remove leading "_" character, if any.
- Remove all characters up to and including the first "\$" character.
- Use the first 17 characters.

5.4.1.7 Generating Save Set Names

Follow the procedure in Table 5–9 to generate save set names from the assignments made to the SAVESET_GEN symbol.

Table 5–9 How to Generate Save Set Names

Step	Action
1.	Decide on a general format for the save set name. <u>Example:</u> <code>volume_name.day_of_month</code> This save set name would contain: <ul style="list-style-type: none"> • Volume name (file name) • Day of the month (extension name)
2.	Write a DCL expression that generates a save set name that uses the assignments provided by the SLS software. Do not use apostrophes. <u>Example:</u> <code>F\$GETDVI(DO_DISK,"VOLNAM")+ ". "+DOM</code>
3.	For every quotation mark (") in the expression, substitute double quotation marks ("). <u>Example:</u> <code>F\$GETDVI(DO_DISK," "VOLNAM" ")+" " . " "+DOM</code>
4.	Place a quotation mark (") at the beginning and end of the statement. <u>Example:</u> <code>"F\$GETDVI(DO_DISK," "VOLNAM" ")+" " . " "+DOM"</code>
5.	Make your SAVESET_GEN assignment. <u>Example:</u> <code>\$ SAVESET_GEN ::= "F\$GETDVI(DO_DISK," "VOLNAM" ")+" " . " "+DOM"</code>

5.4.1.8 Assigning the PROTECTION Symbols

You need to assign volume protection to the volumes where SLS will write the save sets. Assign the PROTECTION symbol the same assignments you would make for the DCL SET FILE /PROTECTION command.

Example:

If the volume needs read and write protection only for system, owner, group, and world, then assign:

```
$ PROTECTION ::= S:RW,O:RW,G:RW,W:RW
```

5.4.2 System Backup Volume Characteristics

Consider the volume characteristics required for your system backup operation. They should include:

- Media type
- Media density
- Reel size, if necessary
- Volume pool from which the media is to taken

Configuring SLS System Backup Operations

5.4 Defining the SLS System Backup Operation

5.4.2.1 Indicating the Type of Media Used for the Backup Operation

Make an assignment to the MEDIA_TYPE symbol that is the type of media to be used for the system backup operation.

Requirement:

You must use one of the media type (MTYPE_n) definitions from the SYSS\$MANAGER:TAPE-START.COM file.

Example:

If you want to write the save set to a 9-track magnetic tape and have an MTYPE_n definition of 9TRACK, you would make the following assignment:

```
$ MEDIA_TYPE ::= 9TRACK
```

5.4.2.2 Assigning the Volume Pool for the Backup Operation

Assign the volume pool name to the TAPE_POOL symbol. This name is the pools of volumes from where the volume for the system backup operation will be selected.

Example:

A volume pool named MONTH_IMAGE is used for monthly image backup operations. Assign the following:

```
$ TAPE_POOL ::= MONTH_IMAGE
```

When to use this symbol:

This symbol is valid only when the PREALLOC or AUTOSEL symbols are also used.

5.4.2.3 Assigning Backup Volume Density

Assign the volume recording density value to the DENSITY symbol.

Example:

The volumes for the backup operation are magnetic tape with a density of 6250 bpi (bits per inch). Assign the following:

```
$ DENSITY ::= 6250
```

Requirement:

Your site must have, at minimum, the amount of tape devices that support the density value assigned to the N_DRIVES symbol.

5.4.2.4 Assigning the Backup Volume Size

Assign the REEL_SIZE symbol a value of the size of the volumes in the specified volume pool.

Example:

If the reels are to be allocated from the specified volume pool are 2400 feet, then assign:

```
$ REEL_SIZE ::= 2400
```

When to use this symbol:

This symbol is valid only when the PREALLOC or AUTOSEL symbols are also used.

5.4.3 System Backup Operator Intervention Policy

The system backup operation can be controlled with a range of operator intervention options. The options range between attended and unattended system backups.

Attended system backup operation:

Requires operator intervention at various stages of the system backup operation, from selecting and loading volumes in real time, to initializing volumes when they are ready for writing.

Unattended system backup operation:

SLS software will acknowledge volumes and write data without operator intervention. The operator can prepare the volumes and devices before the start time of the system backup operation.

5.4.3.1 Example: Attended System Backup Assignments with Restrictions

The following example shows assignments that could be used to control a system backup with a policy of operator intervention, restricting the operator's decisions.

```
$ QUICKLOAD == 0           !Operator acknowledges volume loading
$ PREALLOC == 4            !SLS preallocates four volumes for the job
$ AUTOSEL == 1            !SLS selects additional volumes
$ CONTLOADOPT == 0        !All volumes loaded are specified and initialized
$ UNATTENDED_BACKUPS == 0 !Requires operator intervention
```

5.4.3.2 Example: Attended System Backup Assignments with Without Restrictions

Backup policy might require the operator to make various decisions about the system backup operation. The following example shows assignments that would allow the operator to respond to these decisions:

```
$ QUICKLOAD == 0           !Operator acknowledges volume loading
$ PREALLOC == 0            !Operator allocates volumes
$ AUTOSEL == 0            !Operator selects additional volumes
$ CONTLOADOPT == 2        !Operator has the ability to overwrite or initialize
                           !volumes as they are about to be written
```

5.4.3.3 Example: Unattended System Backup Assignments

The following example shows assignments that could be used to control an unattended system backup operation on a gravity-driven loader device (stacker). For more information about running unattended backup operations, see Section 6.4.

```
$ QUICKLOAD == 1           !SLS software mounts loaded volume
$ QUICKLOAD_RETRIES == 80  !Length of time a volume mount is retried
$ PREALLOC == 0            !No volumes preallocated for the job
$ AUTOSEL == 0            !Additional volumes are not selected by SLS
```

Configuring SLS System Backup Operations

5.4 Defining the SLS System Backup Operation

```
$ CONTLOADOPT == 2           !SLS reinitializes volumes as needed
$ UNATTENDED_BACKUPS == 1    !Does not requires operator intervention
```

Note

During unattended backup operations, SLS retains the volume labels of any initialized volumes that it uses. Volumes that are not initialized are rejected.

5.4.3.4 Acknowledging Loaded Volumes

Use the following options for acknowledging loaded volumes before they are mounted:

- If you want the operator to acknowledge a loaded volume before it is mounted, assign \$ QUICKLOAD == 0.
- If you want SLS software to mount a loaded volume without seeking acknowledgment, assign \$ QUICKLOAD == 1.

5.4.3.5 Allocating Volumes Prior to Running the System Backup Operation

Assign the number of reels to be allocated to the PREALLOC symbol. This allocation occurs before midnight on the day before the system backup operation is to be executed.

Doing this generates a printout of volumes allocated for the next day's backup operations. This allows the operator to prepare for the next day's system backup operations by gathering the allocated volumes.

Example:

If you want to allocate five reels of tape on the midnight before the backup is run, you would use this assignment:

```
$ PREALLOC ::= 5
```

Assign this value (number of reels) to zero if there are no volumes to be allocated ahead of time.

For manual backups:

This symbol is ignored if the system backup operation is manually executed.

5.4.3.6 Enabling SLS Software to Automatically Select Volumes

The AUTOSEL symbol is used by SLS when the system backup operation runs out of preallocated volumes. When appropriately assigned, this symbol enables SLS software to search the SLS volume database for volumes in the free state. Depending upon the assigned value, SLS will either prompt the operator to load these volumes, or automatically load them.

SLS searches for free volumes in the pool name assigned to the TAPE_POOL symbol.

5.4.3.7 Allowable Values for AUTOSEL

There are two allowable values for AUTOSEL. Table 5–10 list these possible values and corresponding descriptions.

Configuring SLS System Backup Operations

5.4 Defining the SLS System Backup Opera-

Table 5–10 Values for AUTOSEL

IF your volumes are stored...	THEN...
<p><u>Near the drives:</u> The operator does not have to:</p> <ul style="list-style-type: none"> • Go far to get the volumes when load requests are displayed on the console. • Determine which volumes may be used. 	<p>Enable automatic volume selection.</p> <pre>\$ AUTOSEL == 1</pre>
<p><u>A significant distance from the drives:</u> The operator has to consider obtaining additional volumes before the backup begins. These additional volumes would then be nearby when the backup begins.</p> <p><u>Recommendation:</u> Set up a procedure that will dictate this situation. Refer to Section 5.4.3.8.</p>	<p>Disable automatic volume selection.</p> <pre>\$ AUTOSEL == 0</pre>

5.4.3.8 Recommended Procedure for Handling Volumes

Table 5–11 describes how to handle additional volumes that might be needed if all preallocated volumes are used before a backup job completes.

Table 5–11 How to Handle System Backup Volumes

Step	Action
1.	<p>Estimate as closely as possible the number of volumes needed for the system backup operation. Assign this value to PREALLOC.</p> <p><u>Result:</u> If too many volumes are allocated, they are returned to the free state. If too few volumes are allocated, the SLS software prompts you for more, as needed.</p>
2.	<p>Review the printed list (prints on SYS\$PRINT) of volumes selected for the day's system backup operations. Obtain these volumes from storage and place them near the devices before the backup begins.</p>
3.	<p>Respond to the SLS prompts that ask for preallocated volumes.</p>
4.	<p>If the system backup operation runs out of preallocated volumes, and AUTOSEL is enabled, enter the STORAGE APPEND command. This instructs SLS software to search the database for similar volumes.</p> <p><u>Result:</u> If the search is successful, SLS software issues a load request for the volumes. If the search is unsuccessful, SLS software prompts for the volume identification. You must then decide which volume to use.</p>
5.	<p>Determine which volume to use.</p>
6.	<p>Load the selected volume on the designated drive and reply to SLS software.</p> <p><u>Example:</u></p> <pre>\$ REPLY/TO=response number</pre>

5.4.3.9 Handling Volume Label Mismatches During the System Backup Operation

The CONTLOADOPT symbol specifies the action to take when a label mismatch occurs while loading a volume. Depending on the value assigned to CONTLOADOPT, the operator is prompted when a label mismatch occurs, to which the operator must reply CONT.

Configuring SLS System Backup Operations

5.4 Defining the SLS System Backup Operation

5.4.3.10 Allowable CONTLOADOPT Values

Appendix Table 5–12 describes the volume label processing criteria, the conditions for accepting or rejecting the volume, and the related CONTLOADOPT assignment.

Table 5–12 Values for CONTLOADOPT

For volume label criteria...	AND...	THEN assign...
Volume labels must match and volumes must be initialized.	If the label does not match or is not initialized, then reject the volume.	\$ CONTLOADOPT == 0
Volume labels must match. A volume not initialized must be confirmed.	<ul style="list-style-type: none"> If the label does not match, then reject the volume. If the label is blank, then prompt the operator for confirmation of the volume. If the label matches, then process the volume. 	\$ CONTLOADOPT == 1
Volume labels must match. A volume not initialized OR mismatched volume label must be confirmed.	<ul style="list-style-type: none"> If the label is blank or does not match, then prompt the operator for confirmation of the volume. If the label matches, then process the volume. 	\$ CONTLOADOPT == 2

5.4.4 System Backup Media Resource Allocation

Media resource allocation for system backup operations concerns the number of save sets that can be placed on a single volume.

5.4.4.1 Considerations for More Than One Save Set on One Volume

If you want to write more than one save set to a single set of volumes, assign a string of at least one character to the CONTINUE symbol.

If you do not want to write more than one save set to a volume, assign a null string to the CONTINUE symbol.

5.4.4.2 Assigning Strings to the CONTINUE Symbol

The string assigned to CONTINUE is used by SLS as a file name without device, directory, file type, or version number. Therefore, this assignment must be compatible with VMS file naming conventions.

If the string assigned to the CONTINUE symbol in a specific _SBK.COM file is unique from all other strings in other _SBK.COM files, save sets generated by this _SBK.COM will be written on volumes or volume sets distinct from those volume or volume sets used by the other _SBK.COM files.

If more than one _SBK.COM file shares the same CONTINUE

symbol string, then the save sets created by those _SBK.COM files are written on the same volume or volume sets.

Example:

Two system backup operations run at different times on the same evening:

- One is an incremental system backup operation of source code files from one disk
- The other is an incremental system backup operation of software documentation a different disk

The source code and documentation both belong to the PET project. To write the save sets from each system backup operation to the same volume, assign the same string to the CONTINUE symbol in each *_SBK.COM file, such as:

```
$ CONTINUE ::= PET
```

5.4.5 System Backup Volume Disposition

Consider the following when determining the completion processing for volumes used for system backup operations:

- SLS system history file processing
- How long the volume is to be retained
- Where the volume will be stored (on site or off site)
- The generation of printed labels
- Any pertinent information to be recorded in the SLS volume database

5.4.5.1 Specifying Symbols for SLS System History Files

The symbols in a *_SBK.COM file that control the creation and maintenance of SLS system history files are HISTORY_SET and SBUPDT_Q.

Disabling SLS system histories:

If you do not want a history file maintained for the backup operations executed with this file, set these symbols to null strings.

5.4.5.2 Naming Your SLS System History Set

Assign the name of the SLS system history set to which the system backup operation belongs to the HISTORY_SET symbol.

Example:

If the system backup operation is a monthly image and you want to maintain the SLS system history file for it, you could use a SLS system history file set named MONTHLY:

```
$ HISTORY_SET ::= MONTHLY
```

Requirement:

The SLS system history set name must be defined in the TAPESTART.COM file with a HISNAM_n assignment. Refer to Section 4.2.1.1 for more information.

5.4.5.3 Naming the SLS System History Processing Queue

Assign the name of the queue where the system history processing jobs will be submitted to the SBUPDT_Q symbol. Include any batch qualifiers, such as /AFTER and /NOPRINT.

Example:

If you want your history database processed on the SYS\$BATCH queue at 11:00 p.m., assign:

```
$ SBUPDT_Q ::= SYS$BATCH/AFTER=23:00
```

Configuring SLS System Backup Operations

5.4 Defining the SLS System Backup Operation

5.4.5.4 Setting the Number of Days for Volume Retention

Assign the number of days to retain volumes to the SCRATCH_DAYS symbol. This determines when volumes are automatically released for reuse or placed in the transition state.

Dependency:

The action taken depends on the assignment of FRESTA in the SYS\$MANAGER:TAPE TART.COM file. Refer to the *Media and Device Management Services for Open VMS Guide to Operations* for more information.

Assigning values:

Supply an integer value greater than zero. If the tapes are to be retained indefinitely, assign a null string.

Example:

To set the volumes used for an image system backup operation of a data disk for one year, assign:

```
$ SCRATCH_DAYS ::= 365
```

Requirement:

This value must be the same for all *_SBK.COM files with the same value for the CONTINUE symbol.

5.4.5.5 Setting Volume Off-Site and On-Site Dates

There are two symbols for controlling the off-site and on-site dates for volumes stored in an off-site vault: OFFSITE_DATE and ONSITE_DATE.

1. The assignment to the OFFSITE_DATE symbol specifies the date to send volumes to an off-site storage location.
2. The assignment to the ONSITE_DATE symbol specifies the date to bring volumes back from an off-site storage location.

Configuring SLS System Backup Operations

5.4 Defining the SLS System Backup Opera-

5.4.5.6 Allowable OFFSITE_DATE and ONSITE_DATE Assignments

Appendix Table 5–13 shows appropriate assignments to the OFFSITE_DATE and ONSITE_DATE symbols.

Table 5–13 Values for OFFSITE DATE and ONSITE DATE

IF you...	THEN assign...
Do not use off-site storage	<pre>\$ OFFSITE_DATE == "" \$ ONSITE_DATE == ""</pre>
Want to specify these values in the *_SBK.COM file, assign a specific time or use VMS delta time to specify a certain number of days from the backup date	<p><u>Time:</u></p> <pre>\$ OFFSITE_DATE ::= 01-DEC-1991 \$ ONSITE_DATE ::= 01-DEC-1992</pre> <p><u>Days from the backup date:</u></p> <pre>\$ OFFSITE_DATE ::= "+30-" \$ ONSITE_DATE ::= "+60-"</pre> <p><u>Note:</u> These examples indicate 30 and 60 days from the current date. The quotation marks ("), plus sign (+), and minus sign (-) are required.</p>
Want to use the values determined in the SLSS\$SEM:SET_VAULT_DATES.COM) file on a day to day basis <u>More information:</u> Refer to <i>Media and Device Management Services for Open VMS Guide to Operations</i> for a description of vault_scheduling.	<pre>\$ OFFSITE_DATE == - F\$TRNLNM("SLS\$OFFSITE_DATE") \$ ONSITE_DATE == - F\$TRNLNM("SLS\$ONSITE_DATE")</pre> <p><u>Note:</u> These examples show continuation lines.</p>

5.4.5.7 Printing Volume Labels

The TAPE_LABELS symbol determines when volume labels are printed. This symbol is meaningful only if the LBL symbol has an assignment in the SYS\$MANAGER:TAPESTART.COM file.

Configuring SLS System Backup Operations

5.4 Defining the SLS System Backup Operation

5.4.5.8 Allowable Assignments to TAPE_LABELS

Appendix Table 5–14 describes the label printing capabilities provided by SLS and the assignments that enable them.

Table 5–14 Values for TAPE_LABELS

IF you want...	THEN assign...
No printed volume labels	\$ TAPE_LABELS == 0
Printed volume labels for the volumes as they are allocated Caution: When using this option, the labels may not have the correct value in the Next Volume field on the label because the subsequent volumes have not been allocated at the time the label is printed.	\$ TAPE_LABELS == 1
Printed volume labels for the volumes as the next one starts (that is, prints the label for the volume when it is full). The label for the last volume used is printed when the job completes.	\$ TAPE_LABELS == 2
Printed volume labels when the job completes	\$ TAPE_LABELS == 3

5.4.5.9 Assigning a Note to a Volume

Assign a string to the NOTES symbol. This string becomes a note on the volume record.

Example:

To include a note describing your monthly image backup, assign:

```
$ NOTES ::= MONTHLY IMAGE
```

5.4.6 System Backup Device Control

Considerations for backup device control include the type and number of tape devices to be used and are described in the following sections.

5.4.6.1 Assigning the Backup Tape Device

Use Appendix Table 5–15 to identify the tape device or tape device types you want to use for the system backup operation.

Table 5–15 Values for DRIVE TYPE

IF you want...	THEN assign...
SLS software to automatically select the tape device.	assign a null string Example: \$ DRIVE_TYPE ::= ""
To specify a tape device.	the tape device(s). Example: \$ DRIVE_TYPE ::= MUA2:,MUA3:

5.4.6.2 Controlling the Number of Drives Used for a System Backup Operation

Assign a value indicating the number of drives to use for the backup job to the N_DRIVES symbol. SLS software prompts the operator to load this number of drives with volumes before any writing occurs.

Configuring SLS System Backup Operations

5.4 Defining the SLS System Backup Opera-

Enabling SLS to prompt for drives:

If you want SLS software to prompt the operator for the number of drives when the backup begins, assign a value of zero.

Value limits:

You must assign a value between one and the number of drives you have that accommodates the density specified by the DENSITY symbol.

Example:

If you have 10 drives of the same density assigned to the DENSITY symbol, but the system backup operation requires only half of them, assign:

```
$ N_DRIVES == 5
```

5.4.6.3 How SLS Software Implements N_DRIVES During a System Backup Operation

Appendix Table 5–16 describes how SLS software implements the N_DRIVES assignment to a system backup.

Table 5–16 SLS Implementation of N_DRIVES Symbol

Stage	Action
1.	SLS software issues a request to load media on the number of drives specified by N_DRIVES.
2.	The operator loads the media on the drives, then replies to SLS software.
3.	The system backup begins writing data to the first drive.
4.	When the volume has been filled, SLS software: <ul style="list-style-type: none">• Begins writing to the next drive• Issues a request to load a volume on the first drive
5.	All subsequent drives are processed as described in Stages 3 and 4 until all designated files have been saved.

5.4.7 System Backup Status and Information Reporting

Status and information reporting tasks include:

- Job notification
- Progress reporting
- Recording the names of files that have been saved

Configuring SLS System Backup Operations

5.4 Defining the SLS System Backup Operation

5.4.7.1 Job Notification

Enabling Operator Replies for System Backup Progress Assign a value to the PROGRESS symbol to enable progress reporting. Refer to Appendix Table 5-17:

Table 5-17 Values for PROGRESS Symbol

IF you want to...	THEN assign...
Disable progress reporting	\$ PROGRESS == 0
Enable progress reporting to occur after a set number of files have been saved	The number of files saved before generating a progress report. <u>Example:</u> \$ PROGRESS == 100

Controlling DCL REPLY Messages

The REPLY_MSG symbol specifies the command to send messages when system backup operations start and complete. Assign the DCL REPLY or REQUEST command and desired qualifiers to the REPLY_MSG symbol.

Example 1:

If you want to send messages and a beep to all user terminals that are logged in, assign:

```
$ REPLY_MSG ::= REPLY/USER/BELL
```

Example 2:

If you want to send messages only to TAPES operators, assign:

```
$ REPLY_MSG ::= REQUEST/TO=(TAPES)
```

5.4.7.2 Progress Reporting by Mail

Assign the account name of the account that will receive the message reporting status of the system backup operation to the STATUS_MAIL symbol.

Example 1:

If you want the mail sent to the system account, then use this assignment:

```
$ STATUS_MAIL ::= SYSTEM
```

Example 2:

If you do not want mail sent to anyone, assign a null string to this symbol.

```
$ STATUS_MAIL ::= ""
```

5.4.7.3 Naming the Backup Log File

Assign the name for the log file produced by the system backup operation to the LOG_FILE symbol. You may include DCL PRINT command qualifiers.

Restriction:

Do not specify a disk name, directory name, or file extension.

Example: If you want to name your log file DAILY_INCREMENTAL.LOG, use this assignment:

```
$ LOG_FILE ::= DAILY_INCREMENTAL
```

Configuring SLS System Backup Operations

5.4 Defining the SLS System Backup Opera-

Default file name:

If do not make an assignment to the LOG_FILE symbol, then the file name defaults to SLS\$\$SYBAK;jobname.LOG.

Disable log file printing:

Assign the /NOPRINT qualifier to the log file name to disable printing the log file.

Example:

```
$ LOG_FILE ::= DAILY_INCREMENTAL/NOPRINT
```

5.4.7.4 Creating a Listing File Name

Assign the format of the listing file name in the same manner you assigned the SAVESET_GEN symbol for save set names to the LISTING_GEN symbol.

All string assignments available for the SAVESET_GEN symbol are also available for the LISTING_GEN symbol. An additional string assignment, SAVESET, includes the save set file name. Refer to Section 5.4.1.7 for examples of the string assignments.

Recommendation:

Include the device and directory names in the LISTING_GEN assignment.

5.4.7.5 Controlling Listing File Format

An assignment to the FULL symbol controls the listing file format. The following values are valid:

- If you want a listing file that contains file name, block size, and creation date, then assign \$ FULL ::= 0.
- If you want a listing file that contains file name, block size, creation date, modification date, file identification, allocation size, owner UIC, and expiration date, then assign \$ FULL ::= 1.

5.4.7.6 Printing a Listing File

You have the option to print your listing file when the system backup operation is complete.

To print:

If you want to print the listing file, assign the name of the print queue you want to the PRINT_Q symbol. You may also include any allowable PRINT command qualifier.

Example:

If you want to print the listing file on the SYS\$PRINT queue and delete the file upon completion of the print job, assign:

```
$ PRINT_Q ::= SYS$PRINT/DELETE
```

Not to print:

If you do not want to print the listing file, assign a null string to this symbol.

Example:

```
$ PRINT_Q ::= ""
```

Configuring SLS System Backup Operations

5.5 Files Created During a System Backup Operation

5.5 Files Created During a System Backup Operation

SLS software allows you to distribute log and summary files produced by SLS maintenance and system backup operations. These files can be distributed into four separate directories.

The advantages of distributing these files are:

- Reducing the number of files in a single directory
- Finding log or summary files easier

5.5.1 Summary Files

A summary file is created when a disk is saved. It is used by SLS to determine which volumes to use to restore a specified disk. Each system backup operation creates a summary file for each disk or set of files defined by the FILES_n symbol in the *_SBK.COM file. The summary file contains:

1. A DCL command file that defines symbols to indicate such things as the:
 - Disk that was saved
 - Volumes that were used
 - Start and stop times
 - Final status
2. All OPCOM and VMS BACKUP messages produced during the job
3. Records of the volumes used for the system backup operation
4. Any error messages produced during the system backup operation

Summary files are used to determine:

- Which volumes to use for a SLS full disk restore
- Whether a system backup operation has already been executed on the same day

Summary files are optional. The symbol SUMMARY_FILE, defined in the SBK file for the system backup operation, determines where these files are created and what they will contain.

Directory location:

SL\$SUMMARY_FILES:

Name format:

<disk device name>.SUM_<date and time>_<system backup name>_<nodename>

Example:

DISK\$USER1:SUM_199109101201_SYS_BACKU_NODE01

Deleting files:

You must manually delete old summary files.

5.5.2 Allowable SUMMARY_FILE Values

Appendix Table 5–18 describes the different summary file generation capabilities and the corresponding assignments.

Table 5–18 Values for SUMMARY FILE

IF you...	THEN assign...
Do not want an automatic full disk restore, or if space is critical	<p>\$ SUMMARY_FILE == 0</p> <p>This assignment also disables the ability to detect if the disk has already been saved on the same day.</p> <p><u>Results:</u> To restore the save set, manually select the volumes.</p>
Want an automatic full disk restore, BUT also want to minimize the amount of disk space used by the summary files	<p>\$ SUMMARY_FILE == 1</p> <p><u>Results:</u> Messages that occurred during the restore operation cannot be displayed. Summary files created will occupy about two or three blocks per volume, therefore, the disk space used is minimal.</p>
Want an automatic full disk restore AND want to display messages that occurred during the restore operation	<p>\$ SUMMARY_FILE == 2</p> <p><u>Results:</u> Enables displaying messages. Summary files created will occupy approximately five blocks per volume.</p>

5.5.3 System Backup Log Files

Each system backup operation is performed in a batch process and produces a log file that indicates the success or failure of the system backup operation.

Directory location:

SL\$SYSBAK_LOGS:

Name format:

*.ERR (for error messages)

SYSBAK_<process_id>_<number>.LOG (for other messages)

<system backup name>.LOG (for full trace of system backup job processing)

Specifying a logical name search list:

You can specify a logical name search list for this location if you wish. When specifying a search list the following conditions apply:

- You must specify the directory location for each system backup file in your *_SBK.COM files. Assign the directory location using the LOG_FILE parameter.

Note

Failing to specify the directory location causes all log files to be placed in the first directory in the search list.

- You must create the directories by entering the DCL command CREATE/DIRECTORY.

5.5.4 Temporary History Files

A system backup operation stores history data in a temporary history file. If system history files are updated, then temporary files are created.

Temporary history files are processed at a later time to update the system history files with records of the files backed up during the system backup operation. This process is done in two phases to allow the scheduling of the history file update (SBUPDT), a time-consuming process.

Temporary history files have the file name extension of .HST. When a system backup operation initiates a batch job to update the system history files, these temporary history files are renamed with the file name extension of .HST_DONE.

Directory location:

SLS\$TEMP_HISTORY:

Name format:

<system backup name><node name><disk device name>.HST

5.5.5 Maintenance Log Files

SLS software performs various maintenance operations, such as updating history files (SBUPDT) and cleanup operations. These maintenance operations are performed in batch, and as a result, produce log files.

Directory location:

SLS\$MAINTENANCE_LOGS:

Name format:

Varies according to the maintenance function.

Configuring SLS System Backup Operations

5.5 Files Created During a System Backup

Configuring SLS System Backup Operations

5.5 Files Created During a System Backup Operation

Performing Save Operations

Saving copies of data through the SLS software helps to protect the integrity of the system software and prevents data from becoming lost or damaged. The most common backup operations include:

- Saving files
- Restoring files and complete disks
- Archiving files

The two main SLS backup operations are saving and restoring files.

This chapter contains information about performing routine save operations with the SLS software. For information about performing restore operations, see Chapter 7.

If your site is set up to handle storage requests through standby archiving, you can perform save operations on preallocated media and without constant operator intervention. For information about standby archiving procedures, see Chapter 9.

SLS also supports saving and restoring Oracle Rdb databases through the Oracle RMU. For details on using SLS with Oracle RMU, see Chapter 8.

6.1 Preparing for Save Operations

This section contains information about the tasks related to performing save operations using the SLS software.

Save operations are important because they safeguard against accidental data deletion and/or data loss due to disk corruption. There may be data on your system that is valuable to you and your department. Having one copy of this data centrally located may not be the best way to preserve it.

6.1.1 How SLS Performs Save Operations

To perform save operations, the SLS software creates a batch job that stores the contents of selected:

- Disk files
- Directories
- Disk volumes

Disk volume sets onto one or more tapes or optical cartridges for retrieval at a later time

By default, the VMS Backup utility is used to store data in save sets. With some SLS backup operations, other utilities such as the VMS Copy utility may be used instead.

Performing Save Operations

6.1 Preparing for Save Operations

6.1.2 Types of Backup Operations

There are two types of backup operations. They are:

- System backups
- User backups

System backups can be manually invoked or automatically scheduled depending upon your storage management policy.

User backups are manually invoked by using either the Operator or User Menu, or the DCL STORAGE commands.

6.1.3 Controlling Data Saving Operations

The storage administrator manages operator and user capability to save data. There are a number of processing defaults you can configure in SYSS\$MANAGER:TAPESTART.COM to control the STORAGE SAVE command and Operator and User Save Screens.

Another consideration for controlling operator and user save operations is the location of SLS user history files.

This section describes the symbols in the SYSS\$MANAGER:TAPESTART.COM file that control the STORAGE SAVE command and the Operator and User Save Screens.

6.1.3.1 Defining the Backup Operation Format

SLS software supports the following backup operation formats:

- BACKUP
- ASCII
- EBCDIC

Default:

BACKUP is the default format for save and restore operations.

The BACKUP Format

To save data using the VMS Backup utility, assign the string "BACKUP" to the BAKFMT symbol in the SYSS\$MANAGER:TAPESTART.COM file.

The ASCII Format

For ASCII formatted tapes, SLS software uses ANSI-labeled volumes and the VMS Files-11 Magnetic Tape ACP to interpret the volume formats.

To execute a DCL COPY command to an ASCII formatted volume, assign the string "ASCII" to the BAKFMT symbol in the SYSS\$MANAGER:TAPESTART.COM file.

The EBCDIC Format

For EBCDIC formatted volumes, SLS software runs an internal program that reads from or writes to EBCDIC tapes only.

Because there is no label on EBCDIC tapes, this program requires specifying the blocking factor and record length before starting the save operation.

To save files in EBCDIC format, assign the string "EBCDIC" to the BAKFMT symbol in the SYSS\$MANAGER:TAPESTART.COM file.

6.1.3.2 Restrictions Imposed by the ASCII and EBCDIC Formats

The following restrictions are imposed on the data saved by an ASCII or EBCDIC formatted backup operation:

- Does not produce a printed volume label
- Ignores save set names created for the backup operation
- Ignores the /EXCLUDE qualifier and the "File To Be Excluded" field of the Save and Restore screens
- Ignores default assignments for other fields of the Save and Restore screens, such as CRC
- Does not update the on-line history file

6.1.3.3 Operator Save Screen Option Defaults

Assign a string of six characters to the BAKOPT symbol to set Operator Save Screen option default assignments.

Allowed characters:

The allowed characters are:

- Y for Yes
- N for No

Default:

The default assignment for the BAKOPT symbol is:

```
$ BAKOPT := "YYYYYY"
```

6.1.3.4 Setting the Operator Save Screen Defaults

Appendix Table 6–1 describes setting the default position in BAKOPT string, from the left to the right.

Table 6–1 Setting Save Screen Defaults using BAKOPT

IF you want the default to enable ...	THEN enter "y" in the...
The save operation of locked files	First character position
Verification that the save operation is correct by comparing the saved files to the original files	Second character position
A one-line entry into the batch log file for each file specified	Third character position
A cyclic redundancy check (CRC) to verify that the volume with the saved data is properly written	Fourth character position

Performing Save Operations

6.1 Preparing for Save Operations

Table 6–1 Setting Save Screen Defaults using BAKOPT

IF you want the default to enable ...	THEN enter "y" in the...
<ul style="list-style-type: none"> The recording of any file saved in both the: On-line history file STORAGE REPORT FILE report	Fifth character position
Initialization of a volume prior to a backup operation <u>Caution:</u> Do not initialize optical media. Initializing optical media causes previous data on the optical media to be inaccessible.	Sixth character position

6.1.3.5 Setting the Default Volume Selection Method for User Save Operations

Assign the default volume selection method for user save operations as shown in Appendix Table 6–2:

Table 6–2 Values for BACKUP_DEFAULT_REEL

IF you want users to ...	THEN again ...
Control their own volumes and you want to allocate a new volume for each save question	The null string Example: <code>\$ BACKUP_DEFAULT_REEL := "</code>
Write their save operations to the standby archiving volume <u>For more information:</u> Refer to Section 9.2.5.3	The string "ARCHIVE" Example: <code>\$ BACKUP_DEFAULT_REEL := "ARCHIVE"</code>

6.1.3.6 Defining the Backup Volume Protection

Define the backup volume protection by assigning a hexadecimal value to the PROTECTION symbol in SYS\$MANAGER:TAPESTART.COM.

Table 6–3 How to define the Hexadecimal Protection Code

Step	Action	Example
1.	Determine the access codes for each user category.	S:RWED ,O:RWED, G:RE,W:
2.	For each user category, determine a hexadecimal value by adding the numbers that correspond to each access code, as follows:	System = F, Owner = F, Group = 5, World = 0
	Access Code	Value
	READ	1
	WRITE	2

Table 6–3 How to define the Hexadecimal Protection Code

Step	Action	Example
	EXECUTE	4
	DELETE	8
3.	Sequence the values in the order of World,Group,Owner, then System, and assign the string of hexadecimal values to the PROTECTION symbol	\$ PROTECTION = %X05FF

More information:

Refer to the *Guide to VMS System Security* for more information about protection codes.

6.1.3.7 Defining the Batch Queue Name for SLS Backup Operations

To define the batch queue name for SLS backup operations, assign batch queue name to the BAKQUE symbol in the SYSS\$MANAGER:TAPESTART.COM file.

Allowable options:

You may append the qualifiers /NOSPOOL or /HOLD to the queue name assigned to the BAKQUE symbol. Any other qualifier appended to this symbol will cause a parse error.

Default:

The default assignment for the BAKQUE symbol is:

```
$ BAKQUE := 'F$ELEMENT(0, " / ", BATN)
```

6.1.3.8 Notification of Completed Backup Operations

To be notified when your backup operation is complete, assign one of the following strings to the BACKUP_FINISH symbol in the SYSS\$MANAGER:TAPESTART.COM file:

- **REPLY** to be notified through a REPLY command
- **MAIL** to be notified through mail

Default string:

The default string is MAIL.

6.1.3.9 Supplying Default Volume Size for the STORAGE SAVE Command

Assign the default volume size to the BACKUPSIZE symbol in the SYSS\$MANAGER:TAPESTART.COM file. This assignment defines the default volume size used for save operations performed with the STORAGE SAVE command.

Default:

The default is 2400.

6.1.3.10 Save Operations with Nonlibrary Volumes

There may be times when you need to save files from volumes that are not located in the volume database of your site library. For example, you might receive a tape from another SLS site with files you want to copy.

User backup operations permit the use of volumes that do not have an existing Volume ID record in the volume database. Identify these nonlibrary volumes by entering the keyword "FOREIGN" in the Volume ID field and by describing the volume in the Notes field.

Use the first six characters of the Notes field to store the volume's label. For example, to use a nonlibrary tape, volume labeled "XXYYZZ" and instructions to the operator to locate the volume when requested, store the label name and descriptive text in the Notes field.

Example:

```
/NOTES="XXYYZZ, located in the red box on the floor of the computer room."
```

6.2 Performing Manual System Backups

Description

The Manual System Backup option on the operator menu displays a screen of interactive dialogue prompts that allows you to perform manual system backups by:

- Executing the DO_A_BACKUP.COM command file
- Prompting for specific backup information
- Creating a command procedure file (*_SBK.COM)
- Providing the opportunity to submit the backup operation immediately or at a later time

This option can also be a method of creating a new *_SBK.COM file for automatic backups.

6.2.1 Accessing the Manual System Backup Menu Option

To access the Manual System Backup option, enter 1 from the Operator Menu and press Return.

Result:

The software displays the Manual System Backup screen shown in Figure 6–1.

Figure 6–1 Manual System Backup

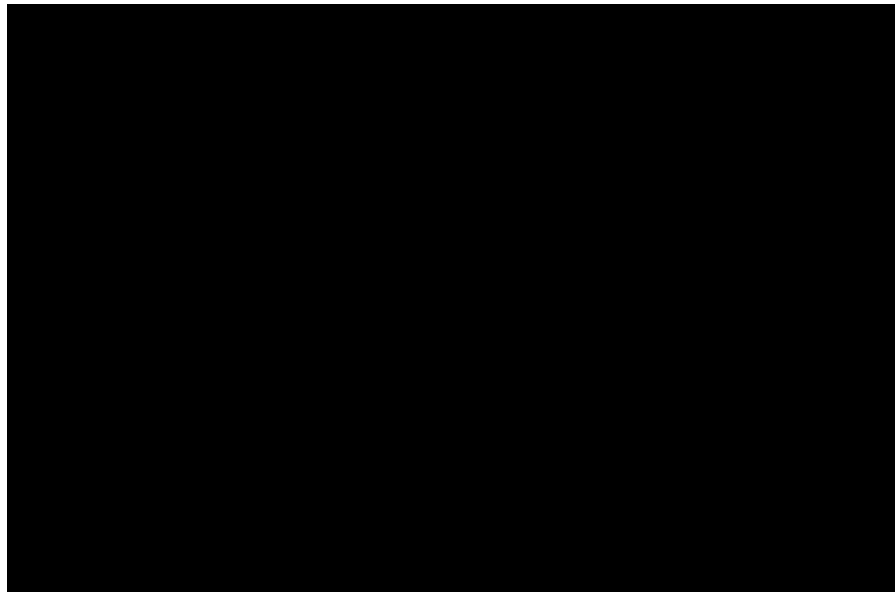

Screen Restriction:

The display may scroll off the terminal screen after 24 lines unless you press the Hold Screen key <F1>. Press the question mark key < ? > to redisplay the screen.

6.2.2 Procedure For Using the Manual System Backup Option

Perform the steps described in Appendix Table 6–4 to use the Manual System Backup menu option.

Performing Save Operations

6.2 Performing Manual System Backups

Table 6–4 Manual System Backup Procedure

Step	System Prompt	Action
1.	Do you want long dialogue [Y]?	<ul style="list-style-type: none"> • IF yes, THEN enter Y and press <Return>. • ELSE press <Return>.
2.	Do you want to run an existing backup [Y]?	<p>IF ...</p> <p>You want to run an existing backup.</p> <p>You want to create a new backup file.</p> <p>THEN ...</p> <p>Enter Y and go to Step 3.</p> <p>Enter N and go to</p>
3.	Existing backup name [List]:	<p>IF you ...</p> <p>Do not know the name of the backup file</p> <p>Know the name of the existing backup</p> <p>THEN ...</p> <p>Press <?> or <Return> Result: The software displays the list of existing system backups and returns you to Step 3.</p> <p>Enter the name of the existing backup file and press <Return>. <u>Result:</u> The software queues the existing backup and returns you to the main menu.</p>
4.	Backup name [SPECIAL]:	<p>Enter the backup name.</p> <p><u>Character limit:</u> The backup name must be 15 characters or less.</p> <p><u>Backup name format:</u> The format for the backup name consists of the user name plus the backup name.</p> <p>IF you want to ...</p> <p>Use the default file (SPECIAL)</p> <p>Create a new backup file</p> <p>THEN ...</p> <p>Press <Return> and go to Step 6.</p> <p>Enter the backup name. <u>Example:</u> SMITH_DUA0_SBK</p>
5.	What files are to be backed up [<CR>=done]	

Performing Save Operations 6.2 Performing Manual System Backups

Table 6–4 Manual System Backup Procedure

Step	System Prompt	Action						
		<ul style="list-style-type: none"> • Enter the file names you want to backup. <u>Required:</u> You must specify the disk, directory and file specification. <u>Example:</u> DUA0: [SMITH]*.*;* <ul style="list-style-type: none"> – <u>IF</u> you want to enter more than one disk, directory or file specification, – <u>THEN</u> press <Return> once. <u>Result:</u> The software prompts you for each file name. • Press <Return> twice when you are finished entering all the files. 						
6.	How often to display progress [No Display]?	<table style="width: 100%; border-collapse: collapse;"> <thead> <tr> <th style="text-align: left; width: 30%;">IF you ...</th> <th style="text-align: left;">THEN ...</th> </tr> </thead> <tbody> <tr> <td>Do not want a display (default)</td> <td>Press <Return></td> </tr> <tr> <td>Want an operator request displayed indicating the progress of the backup</td> <td>Enter the number (in number of files processed) indicating how often to display the message and press <Return>.</td> </tr> </tbody> </table>	IF you ...	THEN ...	Do not want a display (default)	Press <Return>	Want an operator request displayed indicating the progress of the backup	Enter the number (in number of files processed) indicating how often to display the message and press <Return>.
IF you ...	THEN ...							
Do not want a display (default)	Press <Return>							
Want an operator request displayed indicating the progress of the backup	Enter the number (in number of files processed) indicating how often to display the message and press <Return>.							
7.	Qualifiers for VMS Backup command?	<p><u>Required:</u> You must enter a VMS Backup qualifier to continue.</p> <table style="width: 100%; border-collapse: collapse;"> <thead> <tr> <th style="text-align: left; width: 30%;">IF ...</th> <th style="text-align: left;">THEN ...</th> </tr> </thead> <tbody> <tr> <td>You do not know the VMS Backup command qualifier you want to use.</td> <td>Press <?> for suggested qualifiers.</td> </tr> <tr> <td>You know the VMS Backup command qualifier you want to use.</td> <td>Enter the VMS Backup qualifier.</td> </tr> </tbody> </table>	IF ...	THEN ...	You do not know the VMS Backup command qualifier you want to use.	Press <?> for suggested qualifiers.	You know the VMS Backup command qualifier you want to use.	Enter the VMS Backup qualifier.
IF ...	THEN ...							
You do not know the VMS Backup command qualifier you want to use.	Press <?> for suggested qualifiers.							
You know the VMS Backup command qualifier you want to use.	Enter the VMS Backup qualifier.							
8.	Privileges required [BYPASS]	<p>Enter the privileges required to perform the backup.</p> <table style="width: 100%; border-collapse: collapse;"> <thead> <tr> <th style="text-align: left; width: 30%;">IF ...</th> <th style="text-align: left;">THEN ...</th> </tr> </thead> <tbody> <tr> <td>You specify either the /IMAGE, /FAST, or /RECORD qualifier</td> <td>Enter BYPASS and press <Return>. <u>Required:</u> BYPASS is required to use these qualifiers.</td> </tr> <tr> <td>You require more than one privilege</td> <td>Separate them with commas.</td> </tr> </tbody> </table>	IF ...	THEN ...	You specify either the /IMAGE, /FAST, or /RECORD qualifier	Enter BYPASS and press <Return>. <u>Required:</u> BYPASS is required to use these qualifiers.	You require more than one privilege	Separate them with commas.
IF ...	THEN ...							
You specify either the /IMAGE, /FAST, or /RECORD qualifier	Enter BYPASS and press <Return>. <u>Required:</u> BYPASS is required to use these qualifiers.							
You require more than one privilege	Separate them with commas.							

Performing Save Operations

6.2 Performing Manual System Backups

Table 6–4 Manual System Backup Procedure

Step	System Prompt	Action								
9.	Save set name expression [DO-DISK+”.BAK”]	<p>Enter the format used to create save set names.</p> <p><u>Naming conventions:</u> The save set name generally uses the disk name plus the day or date to make it unique.</p> <p><u>Character limit:</u> VMS Backup writes the first 17 characters of a save set name and responds only to that length on RESTORE operations. Use the following symbols to generate a save set name.</p> <ul style="list-style-type: none"> • NODE-Node on which the backup is executed. • DO_DISK-Device name without the colon (MSVAX\$DUA0). • DO_FILES-Parsed file specification (MSVAX\$DUA0:[*...]*.*,*). • DAY-Day of week (MONDAY). • DAY3-Three-character day of week (MON). • DOM-Two-digit day of month (29). • MONTH-Three-character month name (APR). • MONTHN-Two-digit numeric month (04). • YEAR-Four-digit year (1990). • TOPDIR-Top level directory name of DO_FILES. • FNAME-File name portion of DO_FILES. • FTYPE-File type portion of DO_FILES, without the leading “.”. <p><u>Example:</u> DO_DISK + DAY + “.BAK”</p> <p><u>Result:</u> Save set name DUA1TUESDAY.BAK</p>								
10.	What on-line history set is to be updated [None]?	<table border="0"> <thead> <tr> <th>IF you ...</th> <th>THEN ...</th> </tr> </thead> <tbody> <tr> <td>Do not want the history recorded (default)</td> <td>Press <Return> and go to Step 13.</td> </tr> <tr> <td>Want to see a list of currently defined sets</td> <td>Press <?>.</td> </tr> <tr> <td>Want an on-line history of saved files</td> <td>Enter the name of the history set, press <Return> and go to Step 11.</td> </tr> </tbody> </table>	IF you ...	THEN ...	Do not want the history recorded (default)	Press <Return> and go to Step 13.	Want to see a list of currently defined sets	Press <?>.	Want an on-line history of saved files	Enter the name of the history set, press <Return> and go to Step 11.
IF you ...	THEN ...									
Do not want the history recorded (default)	Press <Return> and go to Step 13.									
Want to see a list of currently defined sets	Press <?>.									
Want an on-line history of saved files	Enter the name of the history set, press <Return> and go to Step 11.									

Performing Save Operations 6.2 Performing Manual System Backups

Table 6–4 Manual System Backup Procedure

Step	System Prompt	Action
11.	Name of update batch queue [SYSS\$BATCH]:	<u>IF</u> a history file is created from this backup operation, <u>THEN</u> enter the name of the batch queue on which the job will run.
12.	Time of history update [Immediately after backup completes]:	<p>IF you want ...</p> <p>The history update to be performed immediately after the backup operation completes (default)</p> <p>The history update to be performed immediately after the backup operation completes (default)</p> <p>Specify the time to perform the history update</p> <p>THEN ...</p> <p>Press <Return>.</p> <p>Press <Return>.</p> <p>Enter the time. Use absolute or combination time formats.</p>
13.	Listing expression [None]:	<p>IF you ...</p> <p>Do not want a listing (default)</p> <p>Want to create a listing by defining the format for creating names for files into which a VMS BACKUP listing can be placed</p> <p>THEN ...</p> <p>Press <Return> and go o Step 16.</p> <p>Enter the listing file name expression and go to Step 14. (See the symbol table in Step 9 for a list of valid listing file name expressions.)</p> <p><u>Example:</u> DO_DISK + DAY+ " .LIS"</p> <p><u>Result:</u> This example generates a file name similar to DUA0FRIDAY.LIS.</p>
14.	Create /FULL listing [N]?	

Performing Save Operations

6.2 Performing Manual System Backups

Table 6–4 Manual System Backup Procedure

Step	System Prompt	Action
		<p>IF you want to produce a ... THEN ...</p> <p>BRIEF list which includes file specification, size and creation date of each file (default) Enter N</p> <p>FULL listing which includes a BACKUP date, date of last modification, number of blocks allocated to the file, and record attributes. Enter Y</p>
15.	What queue should listing be printed on [None]?	<p>IF you ... THEN ...</p> <p>Do not want to print out the VMS BACKUP listing (default) Press <Return>.</p> <p>Want to print out the VMS BACKUP listing Enter the name of the printer queue.</p>
16.	Do you want the SLS software to auto select volumes [Y]?	<p>IF you want... THEN ...</p> <p>The SLS software to automatically search the database for free volumes to allocate for the backup (default) Enter Y or press <Return> to enable auto select. <u>Result:</u> The SLS software automatically searches the database for free volumes to allocate for the backup.</p> <p>To select the volumes Enter N. <u>Result:</u> When the backup procedure is submitted, then you will be prompted to select the volumes.</p>
17.	Name of allocated pool [unspecified]:	

Performing Save Operations 6.2 Performing Manual System Backups

Table 6–4 Manual System Backup Procedure

Step	System Prompt	Action	
		IF you want...	THEN ...
		The SLS software to select volumes from any pool (default)	Press <Return>
		To select the volumes from a specified pool of volumes	Enter the volume pool name.
18.	Size of volumes to allocate [default]:	IF you need...	THEN ...
		The default size (default size is site specific)	Press <Return>
		To specify a different size	Enter the correct size.
19.	Note to be recorded in volume notes field [backupname SYSTEM BACKUP]:	IF ...	THEN ...
		You want the default note information	Press <Return>
		You want to change the note information	Enter a note about the contents of the volumes.
20.	Label mismatch action [2]:	If the Volume ID does not match during a load, refer to the following table.	

Performing Save Operations

6.2 Performing Manual System Backups

Table 6–4 Manual System Backup Procedure

Step	System Prompt	Action
		<p>IF you...</p> <p>Require the Volume ID to match the specified volume</p> <p>Require the VOLUME ID to match the specified volume or want a blank volume to be initialized</p> <p>Require the Volume ID to match or want the mismatched volume to be reinitialized (This overrides the current Volume ID).</p> <p style="text-align: center;">-----OPCOM message----- OPCOM displays a confirmation prompt when you enter either option 1 or 2.</p>
		<p>THEN ...</p> <p>Enter 0.</p> <p>Enter 1.</p> <p>Enter 2.</p>
21.	When should labels be printed for tapes [2]:	<p>IF you ...</p> <p>Do not want to print labels</p> <p>Want to print the label when the volume is allocated</p> <p>Want to print the label for the volume when the next volume starts and print the label for that last volume when it completes (default)</p> <p>Want to print the label for all volumes when the backup completes</p>
		<p>THEN ...</p> <p>Enter 0.</p> <p>Enter 1.</p> <p>Enter 2.</p> <p>Enter 3.</p>
22.	Keep tapes for how many scratch days [FOREVER]:	<p>IF you want to ...</p> <p>Keep the volumes for the default time [FOREVER]</p> <p>Specify a time period for keeping volumes before they are released</p>
		<p>THEN ...</p> <p>Press <Return>.</p> <p>Enter the desired time period. Use absolute or combination time.</p>

Performing Save Operations 6.2 Performing Manual System Backups

Table 6–4 Manual System Backup Procedure

Step	System Prompt	Action	
23.	Media type [default]:	<p>IF you want ...</p> <p>The default media type (site specific)</p> <p>To list the available media types</p> <p>To select another media type</p>	<p>THEN ...</p> <p>Press <Return></p> <p>Press <?>.</p> <p>Enter the media type.</p>
24.	Recording density [default]:	<p>IF you ...</p> <p>Want the default recording density (site specific)</p> <p>Change the recording density from the default</p> <p>Have a TA90K or TA90E</p>	<p>THEN ...</p> <p>Press <Return></p> <p>Enter the correct recording density.</p> <p>Enter the compaction option.</p>
25.	Number of tape drives to be used for backup [1]?	<ul style="list-style-type: none"> • <u>I</u>f you want the default number (1), <u>T</u>HEN press <Return>. • <u>E</u>LSE enter the number of drives to be allocated. 	
26.	Mount flags [None]:	<p>IF you ...</p> <p>Do not want any additional qualifiers (default)</p>	<p>THEN ...</p> <p>Press <Return>.</p>

Performing Save Operations

6.2 Performing Manual System Backups

Table 6–4 Manual System Backup Procedure

Step	System Prompt	Action		
		<p>Want additional qualifiers Enter the additional qualifiers to be used when mounting the volume.</p> <p>Select from the following qualifiers:</p> <ul style="list-style-type: none"> • /MESSAGE-Places a message in the log file of each mount. • /READCHECK-Performs read checks. • /TAPE_DATA_WRITE-Enables the tape controllers write data cache. • /WRITECHECK-Performs write checks. 		
<hr/> <p>Note</p> <hr/> <p>Specifying the READCHECK or WRITECHECK qualifier may extend backup time. This is also a duplication if the /VERIFY qualifier is specified with the BACKUP command.</p> <hr/>				
27.	Do you want a VMS MAIL message upon completion [Y]?	<ul style="list-style-type: none"> • IF yes, THEN press <Return> • ELSE enter N and press <Return> 		
28.	Logfile directory [SLS\$\$SYS-BACK:jobname.LOG]?	<table border="0" style="width: 100%;"> <tr> <td style="width: 50%; vertical-align: top;"> <p>IF you ...</p> <p>Do not want to specify the directory and log file generated by the backup job (default)</p> <p>To specify the directory and log file generated by the backup job</p> </td> <td style="width: 50%; vertical-align: top;"> <p>THEN ...</p> <p>Press <Return></p> <p>Enter the name of the directory and log file.</p> </td> </tr> </table>	<p>IF you ...</p> <p>Do not want to specify the directory and log file generated by the backup job (default)</p> <p>To specify the directory and log file generated by the backup job</p>	<p>THEN ...</p> <p>Press <Return></p> <p>Enter the name of the directory and log file.</p>
<p>IF you ...</p> <p>Do not want to specify the directory and log file generated by the backup job (default)</p> <p>To specify the directory and log file generated by the backup job</p>	<p>THEN ...</p> <p>Press <Return></p> <p>Enter the name of the directory and log file.</p>			
29.	Name of parameter to change [NO CHANGES]:			

Performing Save Operations 6.2 Performing Manual System Backups

Table 6–4 Manual System Backup Procedure

Step	System Prompt	Action
		<p>IF you ...</p> <p>Do not want to change a parameter (default)</p> <p>Want to change parameter (the SLS software displays a list of parameters for this backup)</p>
		<p>THEN ...</p> <p>Press <Return></p> <p>1. Enter the parameter and press <Return>. <u>Result:</u> The system prompts for new data. 2. Enter the correction and press <Return>. <u>Result:</u> The system prompts for further changes.</p>
30.	When should this job be run. NEVER-Just make a .COM file, ABORT, or hh:mm [NOW]?	<p>IF you ...</p> <p>Want to start the backup now (default)</p> <p>Want to save the *_SBK.COM file created with this dialogue, but do not want to run the backup yet</p> <p>Do not want to save the *_SBK.COM file you created with this dialogue</p> <p>Want to schedule the backup for later</p>
		<p>THEN ...</p> <p>Press <Return>.</p> <p>Enter NEVER.</p> <p>Enter ABORT.</p> <p>Enter the time you wish to run the backup. Use an absolute or combination time format. Example: [dd-mmm-yyyy[:]] [hh:mm:ss.cc]</p>

Performing Save Operations

6.3 Performing User Save Operations

6.3 Performing User Save Operations

Description

The Save Screen option on the Operator and User Menus displays a screen that allows you to save user files. The SLS software save process executes a batch job that uses the VMS BACKUP utility to save the specified files.

The Operator and User versions of the Save Screen are essentially the same. However, if you access the User version of the Save Screen and do not have the OPER privilege turned on, not all fields display. In Section 6.3.3, the items that do not appear on the non-privileged User Save Screen are identified.

6.3.1 User Interface

Use the keys defined in Appendix Table 6–5 while using the Save Screen menu option.

Table 6–5 Keys Defined for User Save Operations

WHEN you want to ...	THEN ...
Get help	Press <PF2>.
Move to the next field (forward)	Press <Tab>.
Move to the previous field (reverse)	Press the Backspace key.
Scroll file entries	Use the arrow keys.
Submit the save request	Press<Return> when you have finished entering all data.
Exit the screen	Press keypad period <.>.

6.3.2 Save Screen Diagram

Figure 6–2 represents the Save Screen.

Figure 6-2 Save Screen

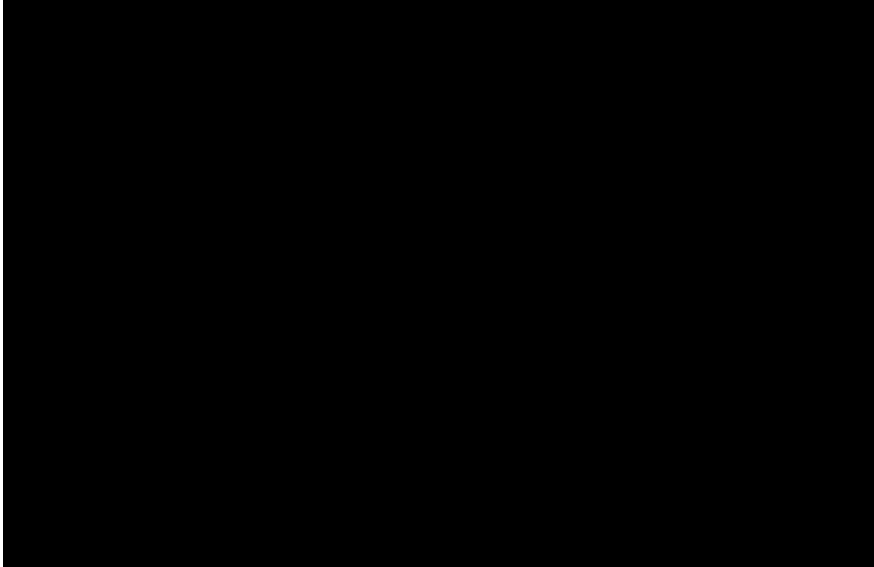

Performing Save Operations

6.3 Performing User Save Operations

6.3.3 Procedure For Using the Save Screen Option

Perform the the steps described in the Appendix Table 6–6 to use the Save Screen menu option.

Table 6–6 Save Screen

Step	System prompt	Action				
1.	-	Enter 2 from the Operator Menu or 1 from the User Menu and press <Return>. <u>Result:</u> The software displays the Save Screen screen (Figure 6–2).				
2.	Files to be included	<ul style="list-style-type: none"> Enter all the file names of the files you want to save. <u>File name limit:</u> Enter up to 16 file names using the following rules: <ul style="list-style-type: none"> Place only one file name on each line. Press the down arrow key < v > to move the next line and enter the next file name. <p><u>Window Display:</u> The window display is limited to three lines. As you add new file names, previous lines will scroll out of the window. Use the up arrow key < ^ > to redisplay the file names that scroll out of the window.</p> <p><u>How to save more than 16 files:</u> To save more than 16 files, re-enter the Save Screen option.</p> <p><u>Wildcard characters:</u> Wildcard characters (* and %) can be used to specify groups of files.</p> <ul style="list-style-type: none"> When you are finished entering all the file names: <table border="0" style="margin-left: 20px;"> <tr> <td>Move to the next field</td> <td>Press <Tab>.</td> </tr> <tr> <td>Begin the save operation</td> <td>Press <Return>.</td> </tr> </table> 	Move to the next field	Press <Tab>.	Begin the save operation	Press <Return>.
Move to the next field	Press <Tab>.					
Begin the save operation	Press <Return>.					
3.	Files to be excluded	<p><u>IF</u> you want to exclude any files that meet other specified criteria (for example: wildcard characters in the file names or date selection criteria), <u>THEN</u> enter any file names to be excluded from the backup operation. <u>File name limit:</u> Enter up to 16 file names.</p>				
4.	Qualifiers	Enter any BACKUP qualifiers not available through the STORAGE SAVE command. For example, /BLOCK and /BUFFER.				
5.	Volume ID [Free Tape]	<p>Select the volume that the backup operation will write the saved files to by using one of the following methods. <u>Character limit:</u> Enter up to eight characters.</p>				

Performing Save Operations

6.3 Performing User Save Operations

Table 6–6 Save Screen

Step	System prompt	Action
		<p>IF you want to ...</p> <p>Allow the system to assign a volume to you (default)</p> <p>Specify a preallocated volume</p> <p>Select the last volume used.</p> <p>Select standby archive for the backup operation</p> <p>Select a foreign volume</p>
		<p>THEN ...</p> <p>Press <Tab> leaving Free Tape in the field.</p> <p>Enter the Volume ID to directly select that volume. <u>Requirement:</u> You must own the volume and have write access to it.</p> <p>Enter LAST. <u>Result:</u> Requests the volume most recently used to save your files.</p> <p>Enter ARCHIVE. This indicates the files are archived to the standby archive volume set. When you get to the Media Notes field, enter the archiving class name. (Check with your storage administrator for the class names).</p> <p>Enter FOREIGN. <u>Result:</u> Indicates the volume is not stored in the SLS site library. When you get to the Media Notes field, enter a note to identify the volume and to indicate its location. <u>IF</u> you entered Y in the /Init? field, <u>THEN</u> the first six characters of the Media Notes field become the label for the foreign volume.</p>
6.	Pool	<p>IF you want to ...</p> <p>Allocate a volume from the user's default pool or from a general default pool</p> <p>Specify a pool name</p>
		<p>THEN ...</p> <p>Press <Tab>.</p> <p>Enter the pool name. <u>Character limit:</u> Enter up to 12 characters.</p>
7.	Saveset	<p>IF you want to ...</p>
		<p>THEN ...</p>

Performing Save Operations

6.3 Performing User Save Operations

Table 6–6 Save Screen

Step	System prompt	Action
		Use the displayed default save set name
		Press <Tab>.
		Change the default save set name
		Enter the new save set name over the displayed default: <u>Save set character limit:</u> The save set name is limited to 17 characters which includes the file name, period and file extension. <u>Example:</u> FILENAME . BAK <u>Restriction:</u> Wildcard characters (* and %) are not allowed.
8.	Scratch	IF you want to ...
		THEN ...
		Use the displayed default scratch date
		Press <Tab>.
		Change the default scratch date
		Enter the new scratch date over the displayed default date. This date determines how long the volume is allocated to the user.
		<u>Note:</u> If you access the Save Screen from the User menu and do not have privileges enabled, this field does not appear.
9.	Time	IF you want to ...
		THEN ...
		The backup operation to start as soon as you exit from the screen (default)
		Press <Tab>.
		To start the backup operation at a later time
		Enter the new time for the backup operation to start. <u>Time formatting rule:</u> Use absolute or combination time.
10.	Media [default]	IF you want to ...
		THEN ...
		To use the displayed default media type (site specific)
		Press <Tab>.
		To change the default media type
		Enter the new media type over the displayed default media type. <u>Character limit:</u> Enter up to 12 characters. <u>Example media types:</u> 9TRACK, TK50, RV02K, TA90K, TA90E

Table 6–6 Save Screen

Step	System prompt	Action														
11.	Format	<p>Enter the type of recording format for the backup operation by using one of the following values.</p> <table style="width: 100%; border: none;"> <tr> <td style="width: 50%; vertical-align: top;">IF the format is ...</td> <td style="width: 50%; vertical-align: top;">THEN ...</td> </tr> <tr> <td style="vertical-align: top;">The standard VMS BACKUP format (default)</td> <td style="vertical-align: top;">Enter BACKUP or press <Tab>.</td> </tr> <tr> <td style="vertical-align: top;">An IBM format</td> <td style="vertical-align: top;">Enter EBCDIC.</td> </tr> <tr> <td></td> <td style="vertical-align: top;">When you get to the blocking factor and record length fields, enter values for both fields.</td> </tr> <tr> <td></td> <td style="vertical-align: top;"><u>Restriction:</u></td> </tr> <tr> <td></td> <td style="vertical-align: top;">On-line user history records are not maintained for EBCDIC formatted volumes.</td> </tr> <tr> <td style="vertical-align: top;">An ASCII code (labeled) format</td> <td style="vertical-align: top;">Enter ASCII.</td> </tr> </table> <p><u>Note:</u> If you access the Save Screen from the User menu and do not have privileges enabled, this field does not appear.</p>	IF the format is ...	THEN ...	The standard VMS BACKUP format (default)	Enter BACKUP or press <Tab>.	An IBM format	Enter EBCDIC.		When you get to the blocking factor and record length fields, enter values for both fields.		<u>Restriction:</u>		On-line user history records are not maintained for EBCDIC formatted volumes.	An ASCII code (labeled) format	Enter ASCII .
IF the format is ...	THEN ...															
The standard VMS BACKUP format (default)	Enter BACKUP or press <Tab>.															
An IBM format	Enter EBCDIC.															
	When you get to the blocking factor and record length fields, enter values for both fields.															
	<u>Restriction:</u>															
	On-line user history records are not maintained for EBCDIC formatted volumes.															
An ASCII code (labeled) format	Enter ASCII .															
12.	Density [default]	<table style="width: 100%; border: none;"> <tr> <td style="width: 50%; vertical-align: top;">IF you want to ...</td> <td style="width: 50%; vertical-align: top;">THEN ...</td> </tr> <tr> <td style="vertical-align: top;">The default density (site specific)</td> <td style="vertical-align: top;">Press <Tab>.</td> </tr> <tr> <td style="vertical-align: top;">To change the default density</td> <td style="vertical-align: top;">Enter the correct density for the media type.</td> </tr> <tr> <td></td> <td style="vertical-align: top;"><u>Example of valid entries:</u></td> </tr> <tr> <td></td> <td style="vertical-align: top;">800, 1600, 2400, 3200, 6250</td> </tr> </table>	IF you want to ...	THEN ...	The default density (site specific)	Press <Tab>.	To change the default density	Enter the correct density for the media type.		<u>Example of valid entries:</u>		800, 1600, 2400, 3200, 6250				
IF you want to ...	THEN ...															
The default density (site specific)	Press <Tab>.															
To change the default density	Enter the correct density for the media type.															
	<u>Example of valid entries:</u>															
	800, 1600, 2400, 3200, 6250															
13.	Length	<table style="width: 100%; border: none;"> <tr> <td style="width: 50%; vertical-align: top;">IF you want to ...</td> <td style="width: 50%; vertical-align: top;">THEN ...</td> </tr> <tr> <td style="vertical-align: top;">Use the displayed default length</td> <td style="vertical-align: top;">Press <Tab>.</td> </tr> <tr> <td style="vertical-align: top;">Change the default length</td> <td style="vertical-align: top;">Enter the correct tape length over the displayed default.</td> </tr> </table>	IF you want to ...	THEN ...	Use the displayed default length	Press <Tab>.	Change the default length	Enter the correct tape length over the displayed default.								
IF you want to ...	THEN ...															
Use the displayed default length	Press <Tab>.															
Change the default length	Enter the correct tape length over the displayed default.															

Performing Save Operations

6.3 Performing User Save Operations

Table 6–6 Save Screen

Step	System prompt	Action																
14.	Blk. Fct	<p>IF you specified an EBCDIC format, THEN enter the number of records for each block of data. The blocking factor is used along with record length.</p> <p><u>Example:</u> 10 80 Where: 10 is the common block factor 80 is the record length in bytes The data written is an 800 byte block.</p> <p><u>Note:</u> If you access the Save Screen from the User menu and do not have privileges enabled, this field does not appear.</p>																
15.	Rec.Len	<p>IF you specified an EBCDIC format, THEN enter the length of the record in bytes.</p> <p><u>Note:</u> If you access the Save Screen from the User menu and do not have privileges enabled, this field does not appear.</p>																
16.	Date Selection	<p>1. Choose one of the following to specify additional criteria by date selection.</p> <table border="0"> <thead> <tr> <th>IF you want to ...</th> <th>THEN ...</th> </tr> </thead> <tbody> <tr> <td><i>Disable</i> the date selection file feature (none is the default)</td> <td>Press <Tab>.</td> </tr> <tr> <td>Select files created, modified, expired or backed up <i>earlier</i> than the time specified</td> <td>Enter 1. <u>Result:</u> Selects the /BEFORE qualifier.</td> </tr> <tr> <td>Select files created, modified, expired or backed up <i>equal to or later</i> than the specified time</td> <td>Enter 2. <u>Result:</u> Selects the /SINCE qualifier</td> </tr> </tbody> </table> <p>2. Press <Tab> to move to the next field. IF you selected either 1 (/BEFORE) or 2 (/SINCE), THEN you <i>must</i> also select qualifiers from the following choices.</p> <table border="0"> <thead> <tr> <th>IF you want to save all files ...</th> <th>THEN ...</th> </tr> </thead> <tbody> <tr> <td>Created before or since the selection date</td> <td>Enter 1 to select Created.</td> </tr> <tr> <td>Modified before or since the selection date</td> <td>Enter 2 to select Modified.</td> </tr> <tr> <td>That have reached their expiration date before or since the selection date</td> <td>Enter 3 to select Expired.</td> </tr> </tbody> </table>	IF you want to ...	THEN ...	<i>Disable</i> the date selection file feature (none is the default)	Press <Tab>.	Select files created, modified, expired or backed up <i>earlier</i> than the time specified	Enter 1 . <u>Result:</u> Selects the /BEFORE qualifier.	Select files created, modified, expired or backed up <i>equal to or later</i> than the specified time	Enter 2 . <u>Result:</u> Selects the /SINCE qualifier	IF you want to save all files ...	THEN ...	Created before or since the selection date	Enter 1 to select Created.	Modified before or since the selection date	Enter 2 to select Modified.	That have reached their expiration date before or since the selection date	Enter 3 to select Expired.
IF you want to ...	THEN ...																	
<i>Disable</i> the date selection file feature (none is the default)	Press <Tab>.																	
Select files created, modified, expired or backed up <i>earlier</i> than the time specified	Enter 1 . <u>Result:</u> Selects the /BEFORE qualifier.																	
Select files created, modified, expired or backed up <i>equal to or later</i> than the specified time	Enter 2 . <u>Result:</u> Selects the /SINCE qualifier																	
IF you want to save all files ...	THEN ...																	
Created before or since the selection date	Enter 1 to select Created.																	
Modified before or since the selection date	Enter 2 to select Modified.																	
That have reached their expiration date before or since the selection date	Enter 3 to select Expired.																	

Performing Save Operations

6.3 Performing User Save Operations

Table 6–6 Save Screen

Step	System prompt	Action
		<p>That have been backed up before or since the selection date Enter 4 to select Backed Up.</p> <hr/> <p style="text-align: center;">Note</p> <hr/> <p style="text-align: center;">If you want to exclude specific files that otherwise meet the required criteria, then enter the file names in the Files to be Excluded field.</p> <hr/>
		<p>3. Press <Tab> to move the cursor to the Date Selection field. <u>IF</u> you want to change the selection date, <u>THEN</u>:</p> <ul style="list-style-type: none"> • Press the arrow keys to move the cursor • Enter the date and time over the displayed date in absolute time format
17.	Ignore-Locks?	<p><u>Requirement:</u> Enabling this field requires either: SYSPRV A systme UIC Ownership of this volume <u>IF</u> you want to save locked files, <u>THEN</u> enter Y to enable this filed. <u>Note:</u> If you access the Save Screen from the User menu and do not have privileges enabled, this filed does not appear.</p>
18.	Verify?	<p><u>Recommended use:</u> Files that contain error sensitive data, such as financial records. <u>IF</u> you want to verify that the backup volume is correct by comparing the backed up files against the original files, <u>THEN</u> enter Y to enable this field. <u>Note:</u> If you access the Save Screen from the User menu and do not have privileges enabled, this filed does not appear.</p>
19.	/LOG?	<p><u>IF</u> you want to place a one-line entry into the batch log file for each target file handled, <u>THEN</u> enter Y to enable this filed. <u>Note:</u> If you access the Save Screen from the User menu and do not have privileges enabled, this filed does not appear.</p>
20.	CRC?	<p><u>IF</u> you want to perform a CRC to ensure that the backup volume is written properly, <u>THEN</u> enter Y to enable this field. <u>Note:</u> If you access the Save Screen from the User menu and do not have privileges enabled, this filed does not appear.</p>
21.	History?	<p><u>IF</u> you want to record any file you save in the on-line history files, <u>THEN</u> enter Y to enable this field. <u>Note:</u> If you access the Save Screen from the User menu and do not have privileges enabled, this filed does not appear.</p>
22.	/Init?	<p><u>Caution:</u> Do not initialize an optical media. For example, an RV02K optical cartridge.</p>

Performing Save Operations

6.3 Performing User Save Operations

Table 6–6 Save Screen

Step	System prompt	Action
		<p>IF ...</p> <p>You want to initialize the backup volume before the backup operation begins.</p> <p>This is the first writing to a magnetic tape volume previously owned by another user.</p> <p><u>Note:</u> If you access the Save Screen from the User menu and do not have privileges enabled, this field does not appear.</p>
		<p>THEN ...</p> <p>Enter Y to enable this field.</p> <p>Enter Y to enable this field. <u>This is required.</u></p>
23.	Media notes:	<p>Enter a short note or description about the volume. <u>Character limit:</u> Enter up to 64 characters.</p> <p>IF you are using ...</p> <p>Standby archiving</p> <p>A foreign volume</p>
		<p>THEN ...</p> <p>The first word in the notes field must define the archive class.</p> <p>The notes field uses the first six characters to define the volume label.</p>
24.	-	<p>Press <Return> to submit the backup operation. <u>Result:</u> The system responds with “Is it okay to send the BACKUP request”?.</p> <p>IF you want to ...</p> <p>Begin the backup operation</p> <p>Abort the backup operation</p>
		<p>THEN ...</p> <p>Enter Y and press <Return>. Result: The software displays the message that the backup operation will begin and which volume the backup operation will use.</p> <p>Enter N, press <Return> and then keypad period <.> to exit the Save Screen Menu option.</p>

6.4 Performing Unattended Backup Operations

With some planning, and the appropriate devices, you can run your system backup operations without an operator to attend to the loading of tape volumes. Under control of SLS software, the device loads media on an as-needed basis. SLS software can run several system backup operations in succession.

To perform unattended backup operations, you can use robotically-controlled jukebox devices (for example, TL820s) or multiple-volume stacker devices (for example, TA90s). For information about working with jukebox devices, see the <REFERENCE>(MDMS_guide). The general information provided here should explain enough additional information for you to run unattended system backup operations with either kind of loader.

Robotically controlled Jukebox Example:

If you have a TF857 (DLT) Digital Linear Tape loader, you can put seven volumes into the loader. SLS will use the volumes, then when all are full, you need to attend the loader to put in new tapes.

TA90 Example:

If you load six volumes into the device and only three are used for the system backup operation, the other three volumes wait until they are needed for the next system backup operation.

Restrictions:

The following restrictions apply when performing unattended backups:

- Volumes selected and loaded in the loading mechanism must be in the free state.
- Volumes must be initialized.
- Volumes must have records in the volume database.

These volume records contain:

- A media type field that matches the MEDIA_TYPE symbol in the *_SBK.COM file
- Either a blank volume pool or a volume pool that matches the TAPE_POOL symbol in the *_SBK.COM file
- Volumes must not be preallocated.
- Volumes must not be hardware write-locked.

For stacker devices, volumes that are write-locked or that do not match the other selection criteria will be unloaded from the drive. SLS attempts to load the next available volume in the loading mechanism before continuing the backup operation.

6.4.1 How an Unattended System Backup Operation Works

Appendix Table 6–7 describes how an unattended system backup operation takes place.

Table 6–7 How Unattended Backup Operations Work

Stage	Action
1.	The operator selects available free volumes and loads them into the appropriate device. The volumes can be loaded in any order.

Performing Save Operations

6.4 Performing Unattended Backup Operations

Table 6–7 How Unattended Backup Operations Work

Stage	Action
2.	To allocate media during a system backup operation, SLS software: <ul style="list-style-type: none">• Loads the media into a drive• Mounts the media• Reads the volume label• Checks the database to ensure the volume is free, is in the correct tape pool, and is the correct media type• Allocates the volume for the system backup
3.	SLS software repeats Step 2 as needed until all data is saved. If the system backup operation ends before all media in the device is used, the device remains ready with the next volume for subsequent save operations.

6.4.2 Modifying System Backup Procedures

With SLS software and appropriate devices, you can perform completely unattended system backups. To do this, you need to set the appropriate symbols in your system backup command files, *_SBK.COM.

Example:

The following example shows how you might set certain system backup symbols to perform unattended system backups with a StorageTek silo.

```
MEDIA_TYPE ::=      ! Volumes to be allocated are of the type DCSC.
DCSC

QUICKLOAD == 1      ! SLS software mounts loaded volume without
                    ! seeking operator acknowledgment.

PREALLOC == 0       ! Volumes are allocated and loaded at the time of the
                    ! system backup operation.

AUTOSEL == 1        ! Volumes are automatically allocated and loaded at
                    ! the time of the system backup operation.

REEL_SIZE ::=       ! TA90 cartridges do not have a size attribute.

TAPE_LABELS == 0    ! Do not print tape labels, as the volumes are already
                    ! labeled in the ACS.
```

1 An *_SBK.COM file that specifies TA90 or TF857 tape devices would set the AUTOSEL symbol to zero, if the devices are being used as stackers. This is because these types of tape devices cannot access preallocated volumes.

6.4.3 Performing Unattended System Backups

To perform an unattended system backup operation, refer to Appendix Table 6–8.

Table 6–8 Performing an Unattended System Backup Operation

Phase	Step	Action
1.	-	Assign required symbols in your system backup command file (*_SBK.COM).
	1	If you are using the Operator Menu System Backup option to create the system backup command file, answer NO when the system asks if you want SLS software to select tapes. If you are manually editing your system backup command file, assign a 0 (zero) to AUTOSEL.
	2	Assign 2 (two) to CONTLOADOPT.
	3	Assign 1 (one) to QUICKLOAD.
2.	-	Select the volumes to use. <u>Restriction:</u> Do not preallocate the volumes you select.
	1	Determine the free volumes from which to select by entering the following command: \$ STORAGE REPORT VOLUME VOLUME,FLAG=FREE,POOL=pool The volume pool name is optional.
3.	-	Choose volumes listed in the report and place them in the device.
	-	Initiate the system backup operation by: Entering the STORAGE START command Entering the STORAGE REQUEUE command Placing an *_SBK.COM file in SLSSYSBAK with automatic scheduling symbols assigned Running a manual system backup operation
4.	-	The SLS Software: 1. Reads the volume label 2. Allocates the volume 3. Checks and updates the SLS database 4. Performs the backup At the end of the volume, the device loads the next volume and the SLS software repeats the process.
	-	<u>OPCOM message:</u> An OPCOM message is generated when the next volume is required, however, it is canceled upon recognition by the SLS software. No reply is necessary.

Performing Save Operations

6.4 Performing Unattended Backup Operations

6.4.4 Performing Unattended System Backups Using Preallocated

Follow the steps described in Appendix Table 6–9 to perform unattended system backups using preallocated volumes.

Table 6–9 Unattended System Backups Using Preallocated VolumeSets

Step	Action		
1.	<p>Search for free volumes by using this command: <code>\$ STORAGE REPORT VOLUME, FLAG=FREE, POOL=<i>pool-name</i></code> <u>Example:</u> <code>\$ STORAGE REPORT VOLUME, FLAG=FREE, POOL=GEN_POOL</code></p>		
2.	<p>Select free volumes from the list.</p> <table border="0" style="width: 100%;"> <tr> <td style="width: 50%; vertical-align: top;"> <p>IF..</p> <p>You want the software to select and allocate multiple volumes.</p> <p>You want to select and allocate multiple volumes.</p> </td> <td style="width: 50%; vertical-align: top;"> <p>THEN ...</p> <p>Use the /QUANTITY qualifier and specify the number of volumes you want to allocate. <u>Example:</u> <code>\$ STORAGE ALLOCATE TK90/QUANTITY=6</code> <u>Result:</u> The SLS software automatically allocates and binds the volumes into a volume set. <u>Command restriction:</u> This command allows no control over which volumes are selected and included in the volume set.</p> <p>1. Allocate the volumes individually. <u>Example:</u> <code>\$ STORAGE ALLOCATE/VOLUME=VOL001</code> <code>\$ STORAGE ALLOCATE/VOLUME=VOL002</code></p> <p>2. Append the volumes into a volume set. <u>Example:</u> <code>\$ STORAGE APPEND VOL001 /VOLUME=VOL002</code> <code>\$ STORAGE APPEND VOL002 /VOLUME=VOL003</code></p> </td> </tr> </table>	<p>IF..</p> <p>You want the software to select and allocate multiple volumes.</p> <p>You want to select and allocate multiple volumes.</p>	<p>THEN ...</p> <p>Use the /QUANTITY qualifier and specify the number of volumes you want to allocate. <u>Example:</u> <code>\$ STORAGE ALLOCATE TK90/QUANTITY=6</code> <u>Result:</u> The SLS software automatically allocates and binds the volumes into a volume set. <u>Command restriction:</u> This command allows no control over which volumes are selected and included in the volume set.</p> <p>1. Allocate the volumes individually. <u>Example:</u> <code>\$ STORAGE ALLOCATE/VOLUME=VOL001</code> <code>\$ STORAGE ALLOCATE/VOLUME=VOL002</code></p> <p>2. Append the volumes into a volume set. <u>Example:</u> <code>\$ STORAGE APPEND VOL001 /VOLUME=VOL002</code> <code>\$ STORAGE APPEND VOL002 /VOLUME=VOL003</code></p>
<p>IF..</p> <p>You want the software to select and allocate multiple volumes.</p> <p>You want to select and allocate multiple volumes.</p>	<p>THEN ...</p> <p>Use the /QUANTITY qualifier and specify the number of volumes you want to allocate. <u>Example:</u> <code>\$ STORAGE ALLOCATE TK90/QUANTITY=6</code> <u>Result:</u> The SLS software automatically allocates and binds the volumes into a volume set. <u>Command restriction:</u> This command allows no control over which volumes are selected and included in the volume set.</p> <p>1. Allocate the volumes individually. <u>Example:</u> <code>\$ STORAGE ALLOCATE/VOLUME=VOL001</code> <code>\$ STORAGE ALLOCATE/VOLUME=VOL002</code></p> <p>2. Append the volumes into a volume set. <u>Example:</u> <code>\$ STORAGE APPEND VOL001 /VOLUME=VOL002</code> <code>\$ STORAGE APPEND VOL002 /VOLUME=VOL003</code></p>		
3.	<p>Load the volumes (in the same order in which the volumes are appended into the set) into the device.</p>		
4.	<p>Submit the backup specifying the Volume ID of the first volume in the volume set.</p>		

Restoring Files and Disks

This chapter contains information about restoring data saved through SLS. You can restore individual files, groups of files, or entire disks.

These tasks are performed by using one of the SLS Menu options and/or the DCL STORAGE commands. All DCL STORAGE commands are described in *Storage Library System for Open-VMS Command Reference Guide*.

7.1 Restoring Data

The considerations for restoring data with SLS software include:

- What computing resources are used
- How notification of completed operations are communicated to operators and users

To control the options for restoring data, make assignments to symbols in the SYSS\$MANAGER:TAPESTART.COM file.

The following sections describe the symbols that control SLS restore operations.

7.1.1 Defining the Restore Operation Queue

Assign the queue for restore operations to the RESQUE symbol.

Allowable qualifiers:

You may append the qualifiers /NOSPOOL or /HOLD to the queue name assigned to the RESQUE symbol. Any other qualifier added to this symbol will cause a parse error.

Default:

The default assignment to the RESQUE symbol is:

```
$ RESQUE ::= 'F$ELEMENT(0,"/",BATN)' /NOSPOOL
```

7.1.2 Setting Operator Restore Screen Option Defaults

Assign a string of five characters to the RESOPT symbol. This sets the Operator Restore Screen menu option default characters.

Acceptable characters:

There are only two acceptable characters:

- Y for Yes
- N for No

Default:

The default string character assignment for the RESOPT symbol is:

```
$ RESOPT := " Y NY"
```

Restoring Files and Disks

7.1 Restoring Data

Missing characters:

These are not used, they must be left blank.

Appendix Table 7–1 describes setting the default string characters in the RESOPT string, from the left to the right.

Table 7–1 Values for RESOPT

IF you want the default to enable...	THEN enter Y in the...
A one-line entry into the batch log file for each file restored	Second character position
A verify pass that the restored copy matches the saved copy	Fourth character position
A cyclic redundancy check (CRC) on the restored file	Fifth character position

7.1.3 Notification when Restore Is Finished

Assign one of the following strings to the RESTORE_FINISH symbol:

- REPLY-notifies through a REPLY command
- MAIL -notifies through a mail message

Default:

The default string is:

```
$ RESTORE_FINISH := MAIL
```

7.1.4 Controlling Data Restore Operations

The storage administrator manages operator and user capability to restore data. There are a number of processing defaults you can configure in SYS\$MANAGER:TAPESTART.COM to control the STORAGE RESTORE command and Operator and User Restore Screens.

Another consideration for controlling operator and user restore operations is the location of SLS user history files.

7.1.5 Restore Operations with Nonlibrary Volumes

There may be times when you need to restore files from volumes that are not located in the SLS database of your site library. For example, you may need to test new software and therefore, need to place the software on-line. Or, you might receive a tape from another SLS site with files you want to copy.

User backup and restore operations permit the use of volumes that do not have an existing Volume ID record in the SLS volume database. Identify these nonlibrary volumes by entering the keyword "FOREIGN" in the Volume ID field and by describing the volume in the Notes field.

Use the first six characters of the Notes field to store the volume's label. For example, to use a nonlibrary tape, volume labeled "XXYYZZ" and instructions to the operator to locate the volume when requested, store the label name and descriptive text in the Notes field.

Example:

```
/NOTES="XXYYZZ, located in the red box on the floor of the computer room."
```

7.2 Restoring a Disk

Description

The Full Disk Restore menu option is used to restore system files to a specified disk.

Full Disk Restore Screen Diagram

Figure 7–1 represents the Full Disk Restore screen.

Figure 7–1 Full Disk Restore Screen

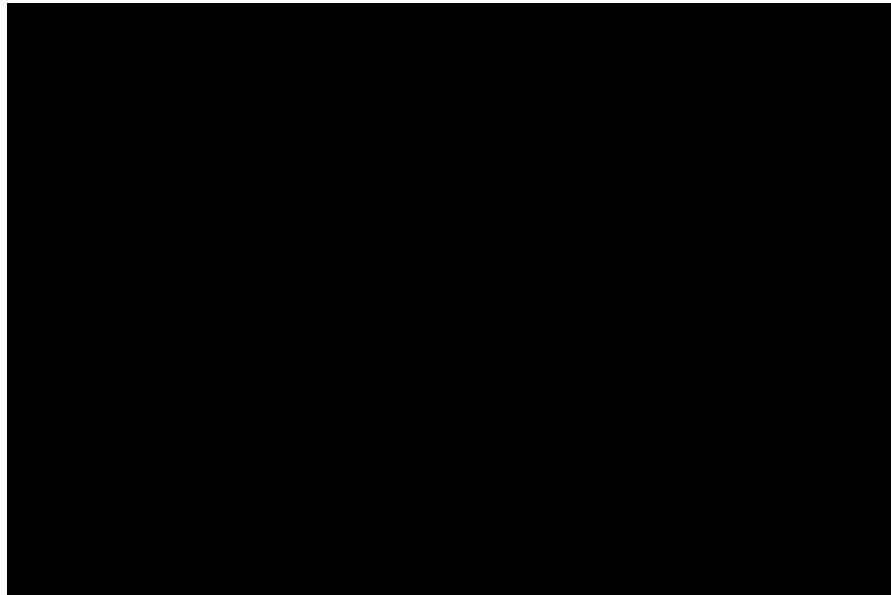

Procedure

Perform the steps described in the Appendix Table 7–2 to use the Full Disk Restore menu option.

Table 7–2 Full Disk Restore

Step	System prompt	Action
1	-	Enter 3 from the Operator Menu and press Return. <u>Result:</u> The software displays the Full Disk Restore screen shown in Figure 7–1.

Restoring Files and Disks

7.2 Restoring a Disk

Table 7–2 Full Disk Restore

Step	System prompt	Action						
2	Disk to be restored (?=List):	<table border="1"> <thead> <tr> <th>IF you...</th> <th>THEN enter...</th> </tr> </thead> <tbody> <tr> <td>Do not know the disk name (default)</td> <td>? <u>Result:</u> The software displays a list of system disks and reprompts for the disk name.</td> </tr> <tr> <td>Know the disk name</td> <td>The disk name and press Return</td> </tr> </tbody> </table> <p><u>Result:</u> The software displays a summary report of system backups for the selected disk and includes:</p> <ul style="list-style-type: none"> • An item line number • Name of the backup • Volumes • Volume status 	IF you...	THEN enter...	Do not know the disk name (default)	? <u>Result:</u> The software displays a list of system disks and reprompts for the disk name.	Know the disk name	The disk name and press Return
IF you...	THEN enter...							
Do not know the disk name (default)	? <u>Result:</u> The software displays a list of system disks and reprompts for the disk name.							
Know the disk name	The disk name and press Return							

Table 7–2 Full Disk Restore

Step	System prompt	Action
3	Selection (lines, DO, SHOW, HELP):	Choose from one of the following.
		IF you want to...
		Select the sequence of backups to be restored
		THEN enter...
		5. A list of one or more item line numbers in the sequence that they are to be used for the full disk restore operation and press Return.
		An entry may consist of a range of line numbers such as "1-3" or "3-1"
		<u>Rule:</u> Separate each entry in the list with commas
		<u>Examples:</u> 1-3,5 = Restores backups 1,2,3,5 6-4 = Restores backups 6,5,4
		<u>Recommended order:</u>
		<ul style="list-style-type: none"> • The first item should be an image backup of the full disk • The next items should be entered in reverse chronological order:
		1,4-2 = Restores backups 1,4,3,2
		6. DO and press <Return>.
		Display the selected items in the order they will be restored
		SHOW ORDER and press Return
		Exit the dialogue
		QUIT and press Return.
		Redisplay the summary backup report for the disk
		SHOW SELECTIONS and press Return.
		Display the errors for a specific backup
		SHOW ERRORS plus the backup item line number. <u>Required privilege:</u> This requires the BYPASS privilege.
		Display the volumes used for the backup
		SHOW VOLUMES plus the backup item line number.
		Display the order of the operation
		SHOW ORDER.
		Display on-line help
		HELP.
4	Name of output disk(s):	Enter the disk name onto which the system files are to be restored to.

7.3 Restoring a File or Group of Files

To restore a single file or a group of files, you must request the specific information to be restored.

7.3.1 Requesting a Restore Operation

A restore operation retrieves copies of previously saved files or save sets from their corresponding storage media or volumes. You must identify the volume on which the files or save sets are located and the location in which to place the restored files or save sets.

Note

If you do not remember the name of the Volume ID on which your files are stored, type the word AUTO in the Volume ID field of the Restore Screen.

Appendix Table 7–3 identifies the different ways you might go about restoring a file or group of files.

Table 7–3 Ways to Restore a File or Group of Files

IF you want to...	THEN select User or Operator Menu option...	OR enter the DCL command STORAGE...
Restore all files or save sets from a particular volume to a specific file	2. Restore Screen	RESTORE <i>file_spec</i> [,...]
Restore specified files from a save set	2. Restore Screen	RESTORE/SAVE_SET= <i>saveset_name</i> <i>file_spec</i>
Verify restored files or save sets	2. Restore Screen	RESTORE/VERIFY <i>volume-id input-spec output-spec</i>
Restore a file or save set over existing files	2. Restore Screen	RESTORE/OVERLAY <i>volume-id input-spec output-spec</i>
Restore a file or save set from a foreign volume	2. Restore Screen	RESTORE/DENSITY= <i>density</i> /FOR-MAT <i>volume-id input-spec output-spec</i>

7.3.2 Using the Restore Screen

This section explains how to request a restore operation from the User or Operator Menu.

Description

The Restore Screen option displays a screen that allows you to restore user files.

User Interface

Use the keys defined in Appendix Table 7–4 while using the Restore Screen option.

Table 7–4 Defined Keys for Restore Screen

IF you want to...	THEN...
Get help	Press PF2.
Move to the next field (forward)	Press Tab.
Move to the previous field (reverse)	Press the Backspace key.
Scroll file entries	Use the arrow keys.
Submit the restore job	Press Return.
Exit the screen	Press keypad period “.” .

Restore Screen Diagram

Figure 7–2 represents the Restore Screen menu.

Figure 7–2 Restore Screen

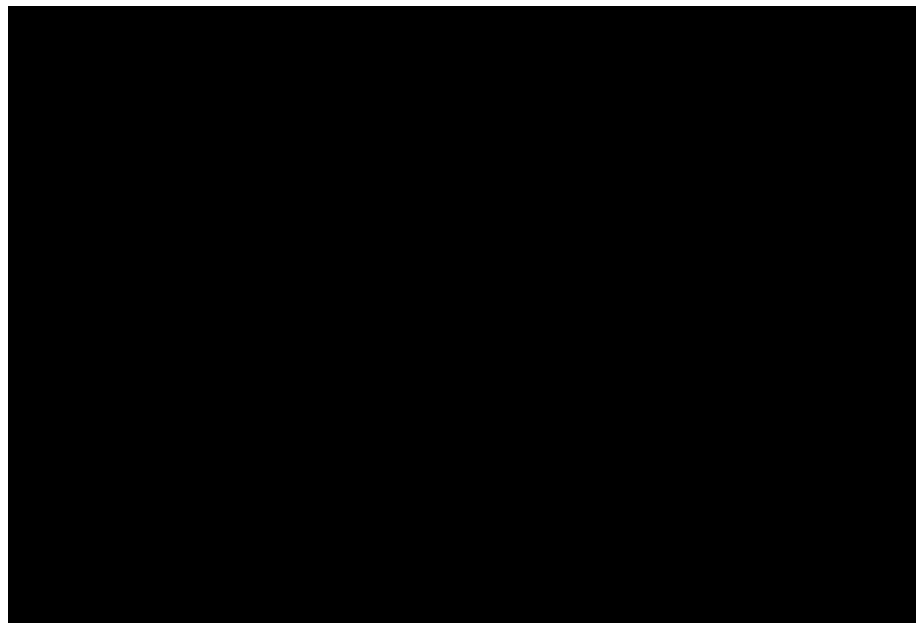

Procedure

Perform the steps in Appendix Table 7–5 to use the Restore Screen option.

Table 7–5 Restore Screen

Step	System prompt	Action
1	-	Enter 4 from the Operator Menu or 2 from the User Menu and press Return. <u>Result:</u> The software displays the Restore Screen as shown in Figure 7–2.

Restoring Files and Disks

7.3 Restoring a File or Group of Files

Table 7–5 Restore Screen

Step	System prompt	Action						
2	Files to be restored	<ul style="list-style-type: none"> Enter all the file names of the files you want to restore. <p><u>File name limit:</u> Enter up to 16 file names using the following rules:</p> <ul style="list-style-type: none"> Place only one file name on each line. Press the down arrow key to move the next line and enter the next file name. <p><u>Window Display:</u> The window display is limited to three lines. As you add new file names, previous lines will scroll out of the window. Use the up arrow key to redisplay the file names that scroll out of the window.</p> <p><u>How to restore more than 16 files:</u> To restore more than 16 files, re-enter the Restore Screen option.</p> <p><u>Wildcard characters:</u> Wildcard characters (* and %) can be used to specify groups of files.</p> <ul style="list-style-type: none"> When you finish entering all the file names: <table border="1"> <thead> <tr> <th>IF you want to...</th> <th>THEN...</th> </tr> </thead> <tbody> <tr> <td>Move the cursor to next field</td> <td>Press Tab.</td> </tr> <tr> <td>Begin the restore operation</td> <td>Press Return.</td> </tr> </tbody> </table>	IF you want to...	THEN...	Move the cursor to next field	Press Tab.	Begin the restore operation	Press Return.
IF you want to...	THEN...							
Move the cursor to next field	Press Tab.							
Begin the restore operation	Press Return.							
3	Output file	<table border="1"> <thead> <tr> <th>IF you...</th> <th>THEN...</th> </tr> </thead> <tbody> <tr> <td>Accept the default file name</td> <td> Press Tab. <u>Result:</u> The software displays the current directory name, places the output file in that directory, and displays the output file name. <u>Note:</u> Files are not restored in the original directory if you have not set default to the original directory. If you want the files restored to the original directory, then specify the directory in the output file line. </td> </tr> <tr> <td>Do not accept the default file name</td> <td>Enter the new directory and filename where the files should be restored.</td> </tr> </tbody> </table>	IF you...	THEN...	Accept the default file name	Press Tab. <u>Result:</u> The software displays the current directory name, places the output file in that directory, and displays the output file name. <u>Note:</u> Files are not restored in the original directory if you have not set default to the original directory. If you want the files restored to the original directory, then specify the directory in the output file line.	Do not accept the default file name	Enter the new directory and filename where the files should be restored.
IF you...	THEN...							
Accept the default file name	Press Tab. <u>Result:</u> The software displays the current directory name, places the output file in that directory, and displays the output file name. <u>Note:</u> Files are not restored in the original directory if you have not set default to the original directory. If you want the files restored to the original directory, then specify the directory in the output file line.							
Do not accept the default file name	Enter the new directory and filename where the files should be restored.							

Restoring Files and Disks 7.3 Restoring a File or Group of Files

Table 7–5 Restore Screen

Step	System prompt	Action										
4	Volume ID	<p>Select the volume that contains the backed up files to be restored. <u>Character limit:</u> Enter up to eight characters.</p> <hr/> <table style="width: 100%; border-collapse: collapse;"> <thead> <tr> <th style="text-align: left; border-bottom: 1px solid black;">IF you...</th> <th style="text-align: left; border-bottom: 1px solid black;">THEN...</th> </tr> </thead> <tbody> <tr> <td style="border-bottom: 1px solid black;">Know the name of the Volume ID of the volume that contains the saved files</td> <td style="border-bottom: 1px solid black;">Enter the Volume ID. <u>Result:</u> Selects the specified volume.</td> </tr> <tr> <td style="border-bottom: 1px solid black;">Do not know the name of the Volume ID and want the software to search for it</td> <td style="border-bottom: 1px solid black;">Enter AUTO. <u>Result:</u> Enables the software to search on-line history files. The system then asks if you want to search the files.</td> </tr> <tr> <td style="border-bottom: 1px solid black;">Entered AUTO and you <i>want</i> the software to search the user history file for the record of a backup operation</td> <td style="border-bottom: 1px solid black;"> <ol style="list-style-type: none"> 1. Enter Yes. <u>Result:</u> The software begins its search of the user history file for a saved copy of a file and replies with a message that it is searching the user backup files. All entries for your files are displayed in a numbered listing on your terminal screen. 2. Enter the number to the left of the entry to use for the restore and press Return. <p><u>Result:</u> The software displays the values for the entry in the Restore Screen.</p> </td> </tr> <tr> <td style="border-bottom: 1px solid black;">Entered AUTO and you <i>do not</i> want the software to search the user history file for the record of a backup operation:</td> <td style="border-bottom: 1px solid black;"> <ol style="list-style-type: none"> 1. Enter No. <u>Result:</u> The software asks if you want to search the system history file for the record of the backup operation. All entries for your files are displayed in a numbered listing on your terminal screen. 2. Enter the number to the left of the entry to use Restoforgthelre-storeDandspress Return. <p><u>Result:</u> The software displays the values of the entry in the Restore Screen. IF you do not select a history set, THEN the software selects the latest entry in the history file and displays these values in the Restore Screen.</p> </td> </tr> </tbody> </table>	IF you...	THEN...	Know the name of the Volume ID of the volume that contains the saved files	Enter the Volume ID. <u>Result:</u> Selects the specified volume.	Do not know the name of the Volume ID and want the software to search for it	Enter AUTO . <u>Result:</u> Enables the software to search on-line history files. The system then asks if you want to search the files.	Entered AUTO and you <i>want</i> the software to search the user history file for the record of a backup operation	<ol style="list-style-type: none"> 1. Enter Yes. <u>Result:</u> The software begins its search of the user history file for a saved copy of a file and replies with a message that it is searching the user backup files. All entries for your files are displayed in a numbered listing on your terminal screen. 2. Enter the number to the left of the entry to use for the restore and press Return. <p><u>Result:</u> The software displays the values for the entry in the Restore Screen.</p>	Entered AUTO and you <i>do not</i> want the software to search the user history file for the record of a backup operation:	<ol style="list-style-type: none"> 1. Enter No. <u>Result:</u> The software asks if you want to search the system history file for the record of the backup operation. All entries for your files are displayed in a numbered listing on your terminal screen. 2. Enter the number to the left of the entry to use Restoforgthelre-storeDandspress Return. <p><u>Result:</u> The software displays the values of the entry in the Restore Screen. IF you do not select a history set, THEN the software selects the latest entry in the history file and displays these values in the Restore Screen.</p>
IF you...	THEN...											
Know the name of the Volume ID of the volume that contains the saved files	Enter the Volume ID. <u>Result:</u> Selects the specified volume.											
Do not know the name of the Volume ID and want the software to search for it	Enter AUTO . <u>Result:</u> Enables the software to search on-line history files. The system then asks if you want to search the files.											
Entered AUTO and you <i>want</i> the software to search the user history file for the record of a backup operation	<ol style="list-style-type: none"> 1. Enter Yes. <u>Result:</u> The software begins its search of the user history file for a saved copy of a file and replies with a message that it is searching the user backup files. All entries for your files are displayed in a numbered listing on your terminal screen. 2. Enter the number to the left of the entry to use for the restore and press Return. <p><u>Result:</u> The software displays the values for the entry in the Restore Screen.</p>											
Entered AUTO and you <i>do not</i> want the software to search the user history file for the record of a backup operation:	<ol style="list-style-type: none"> 1. Enter No. <u>Result:</u> The software asks if you want to search the system history file for the record of the backup operation. All entries for your files are displayed in a numbered listing on your terminal screen. 2. Enter the number to the left of the entry to use Restoforgthelre-storeDandspress Return. <p><u>Result:</u> The software displays the values of the entry in the Restore Screen. IF you do not select a history set, THEN the software selects the latest entry in the history file and displays these values in the Restore Screen.</p>											

Restoring Files and Disks

7.3 Restoring a File or Group of Files

Table 7–5 Restore Screen

Step	System prompt	Action								
		<p>Are using a FOREIGN volume</p> <p>Enter FOREIGN.</p> <p><u>Result:</u> Indicates the volume is not stored in the SLS site library.</p> <ul style="list-style-type: none"> • When you get to the Format field, enter the correct format. • When you get to the Density field, enter the correct density. • When you get to the Media Notes field, enter a note to identify the volume and to indicate its location. 								
5	Saveset	<p><u>Rule:</u></p> <ul style="list-style-type: none"> • IF you entered AUTO in the Volume ID field and the software displayed the correct save set name, THEN press Tab to select the displayed save set name, • ELSE enter the save set name that contains your saved files. *.* is the default. 								
6	Format	<p>Enter the recording format of the volume that contains the files to be restored.</p> <p><u>Requirement:</u> This step is required if the volume is a FOREIGN volume.</p> <table border="1"> <thead> <tr> <th>IF you...</th> <th>THEN...</th> </tr> </thead> <tbody> <tr> <td>Want to use the default format(VMS BACKUP)</td> <td>Press Tab. <u>Result:</u> The cursor moves to the Use/Log field.</td> </tr> <tr> <td>Need the IBM format</td> <td>Enter EBCDIC. <u>Result:</u> The cursor moves to the Blocking Factor field. <u>Restriction:</u> User on-line history files are not maintained for this format.</td> </tr> <tr> <td>Need the ASCII format</td> <td>Enter ASCII.</td> </tr> </tbody> </table> <p><u>Note:</u> If you access the Restore Screen from the User menu and do not have privileges enabled, this field does not appear.</p>	IF you...	THEN...	Want to use the default format(VMS BACKUP)	Press Tab. <u>Result:</u> The cursor moves to the Use/Log field.	Need the IBM format	Enter EBCDIC . <u>Result:</u> The cursor moves to the Blocking Factor field. <u>Restriction:</u> User on-line history files are not maintained for this format.	Need the ASCII format	Enter ASCII .
IF you...	THEN...									
Want to use the default format(VMS BACKUP)	Press Tab. <u>Result:</u> The cursor moves to the Use/Log field.									
Need the IBM format	Enter EBCDIC . <u>Result:</u> The cursor moves to the Blocking Factor field. <u>Restriction:</u> User on-line history files are not maintained for this format.									
Need the ASCII format	Enter ASCII .									

Restoring Files and Disks 7.3 Restoring a File or Group of Files

Table 7–5 Restore Screen

Step	System prompt	Action						
7	Blocking Fct	<p><u>IF</u> you entered EBCDIC in the format field, <u>THEN</u> enter the number of records for each block of data. The blocking factor is used along with record length.</p> <p><u>Example:</u> 10 80</p> <p><u>Where:</u> 10 is the common block factor, and 80 is the record length in bytes. The data written is an 800 byte block.</p> <p><u>Note:</u> If you access the Restore Screen from the User menu and do not have privileges enabled, this field does not appear.</p>						
8	Rec Length	<p><u>IF</u> you entered EBCDIC in the Format field, <u>THEN</u> enter the length of the record in bytes. Record length used in conjunction with the blocking factor to define the format of an EBCDIC tape.</p> <p><u>Note:</u> If you access the Restore Screen from the User menu and do not have privileges enabled, this field does not appear.</p>						
9	Density	<p><u>IF</u> specified a foreign volume in the Volume ID field, <u>THEN</u> enter the recording density for the tape.</p> <p><u>Example of valid entries:</u> 800, 1600, 2400, 3200, and 6250.</p>						
10	Use /LOG?	<p>Enable this field if you want each file restored logged in a batch listing for the job.</p> <p><u>Note:</u> If you access the Restore Screen from the User menu and do not have privileges enabled, this field does not appear.</p>						
11	Verify Restore	<p>Enable this field if you want to verify the restore by comparing it with the original backup volume.</p> <p><u>Note:</u> If you access the Restore Screen from the User menu and do not have privileges enabled, this field does not appear.</p>						
12	Check CRC	<p>Enable this field if you want the CRC to make an additional error check by reading the restored files to ensure they were written properly.</p> <p><u>Note:</u> If you access the Restore Screen from the User menu and do not have privileges enabled, this field does not appear.</p>						
13	Pos	<p>This field cannot be modified. The position is marked by the number of tape marks between the beginning of the volume and the save set file.</p>						
14	Media [default]	<table border="1" style="width: 100%; border-collapse: collapse;"> <thead> <tr> <th style="text-align: left;">IF you want to...</th> <th style="text-align: left;">THEN...</th> </tr> </thead> <tbody> <tr> <td>Use the default media type (site specific)</td> <td>Press Tab.</td> </tr> <tr> <td>Change the default media type</td> <td>Enter the media type over the displayed default media type.</td> </tr> </tbody> </table>	IF you want to...	THEN...	Use the default media type (site specific)	Press Tab.	Change the default media type	Enter the media type over the displayed default media type.
IF you want to...	THEN...							
Use the default media type (site specific)	Press Tab.							
Change the default media type	Enter the media type over the displayed default media type.							

Restoring Files and Disks

7.3 Restoring a File or Group of Files

Table 7–5 Restore Screen

Step	System prompt	Action															
15	Duplicate file action	Choose one of the following options for a file that already exists on the restored disk.															
		<table border="1"> <thead> <tr> <th>IF you want...</th> <th>THEN...</th> <th>Result</th> </tr> </thead> <tbody> <tr> <td>To report error, exit</td> <td>Enter 0.</td> <td>The software places a message in the batch log file indicating the file cannot be restored.</td> </tr> <tr> <td>Make a new version</td> <td>Enter 1.</td> <td>The software creates a new file with the version number one greater than the on-line duplicate file.</td> </tr> <tr> <td>Overlay an existing file</td> <td>Enter 2.</td> <td>The software copies the the restored file onto the existing on-line file and extends it if necessary. The name and version number for the new file are the same as the original on-line file.</td> </tr> <tr> <td>Replace an existing file</td> <td>Enter 3.</td> <td>The software deletes the existing on-line file and creates a new file into which the restored file is copied.</td> </tr> </tbody> </table>	IF you want...	THEN...	Result	To report error, exit	Enter 0 .	The software places a message in the batch log file indicating the file cannot be restored.	Make a new version	Enter 1 .	The software creates a new file with the version number one greater than the on-line duplicate file.	Overlay an existing file	Enter 2 .	The software copies the the restored file onto the existing on-line file and extends it if necessary. The name and version number for the new file are the same as the original on-line file.	Replace an existing file	Enter 3 .	The software deletes the existing on-line file and creates a new file into which the restored file is copied.
		IF you want...	THEN...	Result													
		To report error, exit	Enter 0 .	The software places a message in the batch log file indicating the file cannot be restored.													
		Make a new version	Enter 1 .	The software creates a new file with the version number one greater than the on-line duplicate file.													
Overlay an existing file	Enter 2 .	The software copies the the restored file onto the existing on-line file and extends it if necessary. The name and version number for the new file are the same as the original on-line file.															
Replace an existing file	Enter 3 .	The software deletes the existing on-line file and creates a new file into which the restored file is copied.															
16	Notes	<p>Enter a short note or description about the volume (up to 64 characters). The note description should uniquely identify the volume. For example:</p> <p><u>IF</u> you selected FOREIGN in the Volume ID field, <u>THEN</u> enter a note that identifies the volume to use for the restore.</p> <p><u>Result:</u> The SLS software sends this note to the operator with a load request.</p>															

Restoring Files and Disks 7.3 Restoring a File or Group of Files

Table 7–5 Restore Screen

Step	System prompt	Action						
17	-	<p>Press Return to submit the restore request. <u>Result:</u> The software asks if you want to send the restore request.</p>						
		<hr/> <table style="width: 100%; border-collapse: collapse;"> <thead> <tr> <th style="text-align: left; width: 50%;">IF you...</th> <th style="text-align: left; width: 50%;">THEN...</th> </tr> </thead> <tbody> <tr> <td style="vertical-align: top;">Do not want to start the restore operation</td> <td style="vertical-align: top;"> Enter NO. <u>Result:</u> The software returns you to the beginning of the Restore Screen. </td> </tr> <tr> <td style="vertical-align: top;">Want to start the restore operation</td> <td style="vertical-align: top;"> Enter YES. <u>Result:</u> The software submits the restore operation to batch. SLS software sends the operator a request message to load the appropriate volume. After the volume is loaded, the system begins the restore operation. When the restore operation is complete, SLS software sends the operator a message. The .LOG and .LIS files created during the restore operation are placed into the default directory. </td> </tr> </tbody> </table> <hr/>	IF you...	THEN...	Do not want to start the restore operation	Enter NO . <u>Result:</u> The software returns you to the beginning of the Restore Screen.	Want to start the restore operation	Enter YES . <u>Result:</u> The software submits the restore operation to batch. SLS software sends the operator a request message to load the appropriate volume. After the volume is loaded, the system begins the restore operation. When the restore operation is complete, SLS software sends the operator a message. The .LOG and .LIS files created during the restore operation are placed into the default directory.
IF you...	THEN...							
Do not want to start the restore operation	Enter NO . <u>Result:</u> The software returns you to the beginning of the Restore Screen.							
Want to start the restore operation	Enter YES . <u>Result:</u> The software submits the restore operation to batch. SLS software sends the operator a request message to load the appropriate volume. After the volume is loaded, the system begins the restore operation. When the restore operation is complete, SLS software sends the operator a message. The .LOG and .LIS files created during the restore operation are placed into the default directory.							

Using RMU Backup and Restore with SLS

This chapter describes how to integrate Oracle RMU backup and restore operations into SLS environment.

SLS provides the interface to media management services for the Oracle RMU, as well as the catalog for managed media. The Oracle RMU performs backup and restore operations. SLS passes control to Oracle RMU for backup and restore operations with qualifiers specified in the DBSBK files and STORAGE RESTORE command qualifiers.

The RMU backup and restore operations take place in a context created by SLS, but are still Oracle RMU operations. This chapter describes any minor differences between Oracle RMU operations that can take place inside SLS, and Oracle RMU operations that would be done without SLS. For additional information about Oracle RMU, see the Oracle RMU documentation.

8.1 Overview of RMU Backup and Restore Support

SLS supports the following RMU capabilities:

- Backups using the /ONLINE qualifier. You do not have to take the databases offline to back them up under SLS control.
- Multistreaming backup operations. This means that the backup can write to two or more tape drives simultaneously. With the appropriate hardware configuration, this can significantly speed up the backup operation. SLS does not support the following RMU capabilities:
- Backups of database after-image journals (.AIJ files), using the command RMU/BACKUP/AFTER_JOURNAL.
- Multistreaming restore operations introduced in Rdb Version 5.1. This means that the restore cannot read from two or more tape drives simultaneously. All tape volumes must be accessible to a single tape drive for SLS to control the restore operation.

Of course, you can construct and execute an RMU/RESTORE command outside of SLS, using information on volumes contained in the SLS history files, to use the multistreaming restore capabilities of RMU.

8.2 Using RMU and SLS Together

SLS includes features that support Oracle Rdb Management Utility (RMU) backup (RMU/BACKUP) and restore (RMU/RESTORE) operations on Oracle Rdb databases. SLS integrates media and lifecycle management capabilities with RMU's ability to back up (RDB) relational database information.

Using RMU Backup and Restore with SLS

8.3 Overview of Database System Backup Processing

What this means is that you can use SLS to back up the database information using RMU's data management capabilities. RMU maintains the relations among the data and backs up the data in a relational manner.

8.2.1 Oracle Rdb Minimum Version

To use the integrated database backup and restore support features in SLS, you must use Oracle Rdb, version 4.2 or later. You cannot execute RMU/BACKUP and RMU/RESTORE operations under SLS control for earlier versions of Oracle Rdb.

8.2.2 Types of System Backup Operations

SLS supports the RMU backup feature only for system backup operations that use the new database system backup command files described below. SLS does not support user backups of Rdb databases.

The system backup feature of SLS requires a system backup command file. Adding the RMU backup and restore features into SLS requires a new type of system backup command file. Therefore, we now differentiate between the *OpenVMS system backup* command file and the *database system backup* command file.

OpenVMS System Backup:

This term describes system backup command files and operations that use the OpenVMS Backup Utility software (VMSBUXXX.EXE) embedded in SLS software.

Database System Backup:

This term describes system backup command files and operations that use the RMU software resident on the systems on which SLS and Rdb software is installed and used.

8.3 Overview of Database System Backup Processing

Database system backup processing is similar to SLS processing for an OpenVMS system backup. The following steps occur for a database system backup:

1. The database system backup command file executes in batch, defining symbols and setting the context for the backup to be done.
2. The image SLS\$DBSYSBAK.EXE runs, which uses the defined symbols to formulate an RMU/BACKUP command, load and verify the status of tape devices, and create a subprocess in which to execute the backup.
3. SLS sends the completed RMU/BACKUP command to the subprocess, which executes the command.

SLS keeps log files of the backup in the locations used for OpenVMS system backups. SLS performs history updates to history files that are specifically designed for use as database system backup history files, because their internal format differs from that used by OpenVMS system backups. You can search these history files and restore database files using the STORAGE REPORT SYSTEM and STORAGE RESTORE commands.

8.4 Defining Database System Backup Operations

This section describes the different types of database system backup operations and tells you the assignments to make in the database system backup command file. Because the database system backup command file is similar to the OpenVMS system backup command file, this section only describes symbol assignments that are specific for the database system backup command file.

Using RMU Backup and Restore with SLS 8.4 Defining Database System Backup Oper-

Table 8–1 lists the various things you need to do to define your database system backup operations.

Table 8–1 Process for Defining Database System Backup Operations

Stage	Action
1.	Before you begin database system backup operations is to identify history sets for database backups in TAPESTART.COM. See Section 8.4.1.
2.	Before you can define your database backup operation, you need to locate the command file that controls this behavior. See Section 8.4.2.
3.	Define the BACKUP_TYPE symbol to identify a database system backup operation. See Section 8.4.3.
4.	You may need to modify values for FILES_n and DRIVE_TYPE. See Section 8.4.4.
5.	To use RMU/BACKUP qualifiers, you need to modify the values for QUALIFIERS_n. See Section 8.4.5.
6.	SLS requires that certain symbols be in the command file, although those symbols have no meaning for database system backup operations. You need to define these symbols to be null. See Section 8.4.6.
7.	Before you actually run your database system backup operations, you need to be sure the version of Oracle Rdb software running on your systems is compatible with SLS. See Section 8.4.8.
8.	At this point, you are ready to run your database system backup operations. See Section 8.5.

8.4.1 Identifying Database Backup History Sets in TAPESTART.COM

SLS maintains *history files* in directories that contain information about when specific files were backed up, what volume they are contained on, and so on. Similarly, database system backups write information to *database history files* describing the root file, areas, time of backup, the volume it is on, and other appropriate details.

A series of symbols assignments in the SYS\$MANAGER:TAPESTART.COM file describes the history files. In previous versions of SLS, two values, name and directory, described the system backup history files, for example:

```
$ HISNAM_1 := GENERIC
$ HISDIR_1 := SLS$ROOT:[GENERIC]
```

This definition for a history set is still valid. However, there is now a third value, HISTYP_n, that describes the type of history file that exists in the specified directory. You can use one of two values for the HISTYP_n symbol:

- BACKUP
- RMUBACKUP

For example:

```
$ HISNAM_2 := GENERIC_RMU_HISTORY
$ HISDIR_2 := SLS$ROOT:[HIST.DATABASE_HISTORY]
$ HISTYP_2 := RMUBACKUP
```

Using RMU Backup and Restore with SLS

8.4 Defining Database System Backup Operations

The first history directory specification, without the HISTYP_n parameter, is still valid because SLS defaults the history type to BACKUP if you do not specify it. To specify a history set of type BACKUP, use the following form:

```
$ HISNAM_3 := SYSTEM_HISTORY

$ HISDIR_3 := SLS$ROOT:[HIST.SYSTEM_HISTORY_FILES]

$ HISTYP_3 := BACKUP
```

Database System Backup File History Set Symbol

The database system backup file must include the name of the history set to be updated. For example, for a database system backup to update the history set described immediately above, put the following line in the database system backup file:

```
$ HISTORY_SET ::= GENERIC_RMU_HISTORY
```

Caution

OpenVMS system backup history files and database system backup history files have different internal formats. If the value of the HISTORY_SET symbol in a database system backup file causes the history information to be written to an OpenVMS system backup history, this usually makes the information in that history file unusable. Writing OpenVMS history information to database backup history files has the same consequence.

8.4.2 Locating the Database System Backup Command File

The database system backup command file template supplied with the SLS kit is located at:

```
SLS$SYSBAK:DBSYSBAK.TEMPLATE
```

The database system backup command file uses the following file naming convention:

```
name_DBSBK.COM
```

Where:

name is a meaningful name to the administrator overseeing the backup policy.

8.4.3 Identifying Backup Operation Type

The BACKUP_TYPE symbol specifies the type of backup operation. The symbol assignment identifies either an OpenVMS or a database system backup operation. This symbol appears in both the OpenVMS system backup command file (*_SBK.COM) and the database system backup command file (*_DBSBK.COM).

Assignments:

- OpenVMS system backup operation:

```
$ BACKUP_TYPE ::= VMSBACKUP
```

- Database system backup operation:

```
$ BACKUP_TYPE ::= RMUBACKUP
```

If you do not assign a value to the BACKUP_TYPE symbol, or if no symbol assignment is made (as is the case with existing system backup procedures), the backup operation defaults to an OpenVMS system backup operation.

8.4.4 Modifying Existing Symbols

You may need to change the values for three symbols in the database system backup command file. These symbols have a different meaning than they do for an OpenVMS system backup command file. Appendix Table 8–2 lists the symbols, their purposes, and example assignments in a database system backup file.

Table 8–2 Symbols with New Meanings

Table 8–2 Symbols with New Meanings

Symbol Name	Purpose
FILES_n	<p>Name of the Oracle Rdb database to be saved. You must assign the name of the Oracle Rdb root file to the database name.</p> <p>Example:</p> <pre>\$ FILES_1 ::= DB_DISK:[MFPERS]MF_PERSONNEL_DB.RDB</pre>
DRIVE_TYPE	<p>Name of the tape drives to be used. The value assigned to this symbol accepts the /MASTER qualifier to identify master drives. For more information on using multiple tape devices, refer to the <i>Oracle Rdb Guide to Database Maintenance and Performance</i>. If you do not specify this symbol, the normal defaulting takes place; this means you cannot specify qualifiers such as /MASTER.</p> <p>Examples:</p> <p>This example shows a single tape device used for the database system backup operation:</p> <pre>\$ DRIVE_TYPE ::= \$1\$MUA7</pre> <p>This example shows a master/slave arrangement in which the RMU backup treats the device named \$1\$MUA10 as the master and \$1\$MUA20 as the slave:</p> <pre>\$ DRIVE_TYPE ::= \$1\$MUA10/MASTER, \$1\$MUA20</pre> <p>Note also that if the DRIVE_TYPE symbol specifies more than one drive, then you must set the N_DRIVES symbol in the database system backup file to the number of drives. In the example immediately above, you would make the following assignment:</p> <pre>\$ N_DRIVES == 2</pre>
QUALIFIERS_n	<p>Qualifiers used by the RMU/BACKUP command. For more information on these qualifiers, refer to Section 8.4.5, and to the <i>Oracle Rdb Guide to Database Maintenance and Performance</i>.</p> <p>Do not use:</p> <p>Do not use any of the following qualifiers:</p> <ul style="list-style-type: none"> • /LABEL • /DENSITY • /MASTER • /PROTECTION • /TAPE_EXPIRATION

Using RMU Backup and Restore with SLS

8.4 Defining Database System Backup Operations

8.4.5 Using QUALIFIERS_n

You can use the QUALIFIERS_n symbol, where the digit “n” is replaced by the same digit as that in the FILES_n symbol, to put any valid RMU/BACKUP qualifier (see QUALIFIERS_n in Table 8–2) on the command line. For example, you might want to do this to perform backups by specific area, or to perform incremental backups. For further details on these concepts in a, consult the appropriate Oracle Rdb documentation.

The following example backs up only the three specified areas of the Oracle Rdb database whose root file is specified in the FILES_1 parameter:

```
$ FILES_1 ::= $27$DUA2:[DATABASE.RECORDS]MASTER.RDB
$ QUALIFIERS_1 ::= /INCLUDE=(AREA_21,AREA_22,AREA_23)
```

This example shows how to eliminate four particular areas in a database system backup operation:

```
$ FILES_1 ::= $11$DUA12:[X.Y]EMPLOYEES.RDB
$ QUALIFIERS_1 ::= /EXCLUDE=(AA,BB,CC,DD)
```

Finally, here is an example of an incremental backup:

```
$ FILES_1 ::= $1$DUA33:[TOP]DAILY.RDB
$ QUALIFIERS_1 ::= /INCREMENTAL
```

You may specify any set of RMU/BACKUP qualifiers, except those listed in Table 8–2, as the value of the QUALIFIERS_n symbol.

8.4.6 Nullifying Existing Symbols

Although SLS requires certain symbols for the system backup process to operate successfully, some symbols do not apply to the database system backup operation. For the database system backup operation to be successful, you must assign a null value to symbols that are not meaningful for the database system backup operation.

Requirement:

You must assign null values to the following symbols in the database system backup command file:

- FULL
- LISTING
- PROGRESS
- PRINT_Q
- LISTING_GEN

8.4.7 Compaction issue with RMU Backup on VMS 7.2-1 and 7.3

With VMS 7.2-1 and above the RMU Backups do not happen in compaction mode for SCSI devices. To rectify this issue please set the 'DENSITY' symbol in DBSBK file to 1. For TA90 tape devices the density symbol should be set to COMP.

8.4.8 Specifying Oracle Rdb Software Version

If you are using the Oracle Rdb software multiversion feature, you must ensure the database system backup operation takes place with the right version of Oracle Rdb software.

If the system wide default version is different than the version used to create the database, you must perform some preprocessing to set the proper version for the database system backup operation. Make the following assignment in the database system backup command file:

```
$ PRE_PROCESS_FIRST ::= @SYS$LIBRARY:server_cmd_file n.n /JOB DATE
```

Where:

server_cmd_file is the name of the command file used to specify the appropriate version.

- Prior to version 6.0, use the command procedure SYS\$LIBRARY:RDBVMS\$SETVER
- For Version 6.0 and later, use the command procedure SYS\$LIBRARY:DECRDB\$SETVER *n.n* is the version of Oracle Rdb under which the database was created.

If you do not make this assignment, the database system backup operation will fail.

8.5 Running Database System Backups

You can start a database backup operation automatically or manually.

8.5.1 Running Database Backups Automatically

To run a database system backup operation automatically, assign values to the following automatic scheduling symbols of the database system backup command file:

DAYS_n

TIME_n

NODE_n

For more information on running automatic backup operations, refer to Section 6.4.

8.5.2 Running Database Backups Manually

You can use either of the following methods to run database system backup operations manually:

- DCL command interface
- Operator Menu interface

8.5.2.1 Using the DCL Command Interface

Enter the following command:

```
$ STORAGE STARTUP SYSTEM_BACKUP file_name
```

Where:

file_name is the name of the database system backup command file. For more information, refer to the description of STORAGE STARTUP SYSTEM_BACKUP in *Storage Library System for OpenVMS Command Reference Guide*.

8.5.2.2 Using the Operator Menu Interface

Use Option 1, Manual System Backup, in the Operator Menu interface to create a database system backup file and optionally submit it for processing. Ask for a Long Dialog and specify RMUBACKUP when asked what kind of backup operation to perform.

Using RMU Backup and Restore with SLS

8.6 Using Volume Reports to Identify Database Backups

8.6 Using Volume Reports to Identify Database Backups

You can determine which volumes contain database backups by examining the FORMAT field in a volume report. The FORMAT field indicates the type of backup used to write data to the tape volume. Backup formats cannot be mixed on a single tape volume. Example 8–1 shows a report on a tape volume database that contains volumes of several types, where the volumes DB_BK1 and DB_BK2 were written by RMU/BACKUP.

Example 8–1 Volume Report

```
Run date 17-OCT-1993 13:47 Page 1

Volume Database File Report

Volume Length Status Username Format
-----
GH0001 ***** Free

GH0002 ***** Free

GH0003 ***** Free

GH0004 ***** Free

DB_BK1 Free DB_MEISTER RMUBACKUP

DB_BK2 Alloc DB_MEISTER RMUBACKUP

NICK_2 Alloc ST_NICK BACKUP

NICK_9 Alloc ST_NICK BACKUP

NMJUNK Alloc ST_NICK BACKUP

TST001 ***** Alloc JJONES BACKUP

10 record(s) found

MSTRPT/DIRECT
VOLN/SORT/WIDT=8 , LGTH/WIDT=6 , FLAG/WIDT=6 , USER/WIDT=12 , FRMT/WIDT=16
```

8.7 Restoring a Database

SLS supports restore (RMU/RESTORE) operations on Oracle Rdb databases. SLS integrates media and lifecycle management capabilities with RMU's ability to restore (RDB) relational database information.

SLS allows you to control the operation with the /DB_CMDQUALS and /DB_FILQUALS qualifiers to the STORAGE RESTORE command. These command qualifiers pass information to the Oracle RMU which performs the actual file restoration.

Note

The only way you can restore an Oracle Rdb database is through the use of the STORAGE RESTORE command. You cannot restore an Oracle Rdb from the Restore Screen.

8.7.1 Before Restoring an Oracle Rdb Database

You may specify only one database with the STORAGE RESTORE command. If you specify more than one, SLS restores only the first one.

Before you restore a database (or area of a database), you need to consider the following:

Table 8–3 Process for Restoring a Database

Stage	Action
1.	Choose to use either (or both) the /FORMAT or /HISTORY qualifiers, designating to SLS that the restore operation involves the Oracle RMU. See Section 8.7.1.1.
2.	Specify the version of Oracle Rdb under which the database files were created. See Section 8.7.1.2.
3.	Determine the appropriate Oracle RMU file and command qualifiers. See Section 8.7.1.3.
4.	If necessary, create an options file to specify additional restore operation qualifiers. See Section 8.7.1.4.

8.7.1.1 Designating an Oracle RMU Restore Operation

You must use either (or both) the /FORMAT or /HISTORY qualifier on your STORAGE RESTORE command to restore Oracle Rdb files.

/HISTORY

Use the /HISTORY qualifier with the name of a specific history set. The STORAGE RESTORE will be able to determine from the stored internal format of the history file which backup software to use to restore the requested file. The format of the /HISTORY qualifier is as follows:
/HISTORY=history_name

Where:

history_name is the symbolic name given to the History set. Use the HISNAM_n symbol assignment in TAPESTART.COM.

The /HISTORY qualifier, because it explicitly names the history set to search, is more efficient than using the /FORMAT qualifier alone.

/FORMAT

The /FORMAT qualifier accepts the value of RMUBACKUP. When you use /FORMAT=RMUBACKUP on the STORAGE RESTORE command line, only those history files that contain database system backup records are searched.

8.7.1.2 Specifying Oracle Rdb Software Version

Similar to the requirement described in Section 8.4.8, if you are using the Oracle Rdb software multiversion feature and the systemwide default is different than the version used to create the database, then you must include the following qualifier on a STORAGE RESTORE command:

```
/PRE_PROCESSING ::= @SYS$LIBRARY:server_cmd_file n.n /JOB DATE
```

Using RMU Backup and Restore with SLS

8.7 Restoring a Database

Where:

setver_cmd_file is the name of the command file used to specify the appropriate version.

- Prior to version 6.0, use the command procedure SYS\$LIBRARY:RDBVMS\$SETVER
- For Version 6.0 and later, use the command procedure SYS\$LIBRARY:DECRDB\$SET-
VER

n.n is the version of Oracle Rdb the database was created.

If you do not make this assignment, the restore operation will fail.

8.7.1.3 Specifying RMU/RESTORE Qualifiers

RMU/RESTORE supports an extensive set of qualifiers, which are divided into command qualifiers, and file or area qualifiers. To specify any of these qualifiers to be used, include them as a quoted string value on the /DB_CMDQUALS or /DB_FILQUALS STORAGE RESTORE qualifiers.

For example, to include the /DIRECTORY and the /PAGE_BUFFERS command qualifiers on the RMU/RESTORE command, specify the following:

```
$ STORAGE RESTORE/DB_CMDQUALS="/DIRECTORY=[TOPLEVEL]/PAGE_BUFFERS=5" ...
```

In this example, the RMU/RESTORE command includes the /THRESHOLDS qualifier:

```
$ STORAGE RESTORE/DB_FILQUALS="/THRESHOLDS=(...)" ...
```

For a complete description of the RMU/RESTORE qualifiers, refer to the *Oracle Rdb RMU Reference Manual*.

8.7.1.4 Using an Options File

When you need to declare a lengthy amount of information for an Oracle RMU command qualifier, you can create an options file. The options file consists of information you would include in the command for the operation. More information on the use and syntax of options files can be found in the RMU /RESTORE documentation, as this is an RMU feature.

Refer to Section 8.7.2.2 and Section 8.7.2.3 for an example implementations of an options file.

8.7.2 Example Oracle RMU Restore Scenarios

This section shows example restore scenarios. They are a guideline for performing restore operations; each particular operation will require its own set of considerations.

8.7.2.1 Full Restore of a Single File Database

This example shows a full restore of an Rdb V6.0 single file database. The restore will place the database in a different location.

```
DATABASE NAME: DISK$USER1:[RDB_DATABASES]SLS_SF.RDB HISTORY SET:
GENERIC_RMU_HISTORY

$ STORAGE RESTORE/HISTORY=GENERIC_RMU_HISTORY -

_ $ /PRE_PROCESS="@SYS$LIBRARY:RDBVMS_SETVER 6.0 /JOB DATE" -

_ $ /DB_CMDQUALS="/DIRECTORY=DISK$USER1:[BACKUP_FILES]/NOCCD" -

_ $ DISK$USER1:[RDB_DATABASES]SLS_SF.RDB
```

8.7.2.2 Full Restore of Multiple File Database

This example shows a full restore of an Rdb V6.0 multi-file database. The restore will place the database in a different location. Because of the nature of this restore operation, much information is needed to be specific. An options file is used to specify the areas.

The database has the following distribution:

DATABASE NAME: DISK\$USER1:[RDB_DATABASES]SLS_MF.RDB

HISTORY SET: GENERIC_RMU_HISTORY

The organization of the database is as follows:

```
[RDB_DATABASES]

SLS_MF.RDB

SLS_MF.RDA

SLS_MF.SNP

[.AREA1]

SLS_DEV1_AREA1.RDA

SLS_DEV1_AREA1.SNP

[.AREA2]

SLS_DEV1_AREA2.RDA

SLS_DEV1_AREA2.SNP

[.AREA3]

SLS_DEV1_AREA3.RDA

SLS_DEV1_AREA3.SNP
```

For this database, the area name is the same as the .RDA filename. Because of the naming convention, the SLS_MF database contains areas SLS_DEV1_AREA1, SLS_DEV1_AREA2 and SLS_DEV1_AREA3.

The contents of the options file is as follows:

```
SLS_DEV1_AREA1/FILE=DISK$USER1:[BACKUP_FILES]/SNAP=(FILE=DISK$USER1:[BACKUP_
FILES])

SLS_DEV1_AREA2/FILE=DISK$USER1:[BACKUP_FILES]/SNAP=(FILE=DISK$USER1:[BACKUP_
FILES])

SLS_DEV1_AREA3/FILE=DISK$USER1:[BACKUP_FILES]/SNAP=(FILE=DISK$USER1:[BACKUP_
FILES])
```

The following command executes the restore operation:

```
$ STORAGE RESTORE/HISTORY=GENERIC_RMU_HISTORY -
_ $ /PRE_PROCESS="@SYS$LIBRARY:RDBVMS_SETVER 6.0 /JOB DATE" -
_ $ /DB_CMDQUALS= -
```

Using RMU Backup and Restore with SLS

8.7 Restoring a Database

```
_$ "/DIREC-  
TORY=DISK$USER1:[BACKUP_FILES]/NOCDD/OPTIONS=DISK$USER1:[RDB_DATABASES]MFRES  
T.OPT" -
```

```
_$ DISK$USER1:[RDB_DATABASES]SLS_MF.RDB
```

8.7.2.3 Full Restore of an Area of a Multiple File Database

This example shows a restore of a single area, SLS_DEV1_AREA3, from the multi-file database used in example 2 (see above for further information). An options file must be used for this kind of restore since the syntax of the STORAGE RESTORE command does not allow the addition of a storage area name with the database name.

This example shows that the real control of the restore operations is in the use of the /DB_CMDQUALS and /DB_FILQUALS qualifiers and the the options file to pass parameters through SLS to the Oracle RMU.

The contents of the options file is as follows:

```
SLS_DEV1_AREA3/FILE=DISK$USER1:[BACKUP_FILES]/SNAP=(FILE=DISK$USER1:[BACKUP_  
FILES])
```

The following command executes the restore operation:

```
$ STORAGE RESTORE/HISTORY=GENERIC_RMU_HISTORY -
```

```
_$ /PRE_PROCESS="@SYS$LIBRARY:RDBVMS_SETVER 6.0 /JOB DATE" -
```

```
_$  
/DB_CMDQUALS="/AREA/NOCDD/OPTIONS=DISK$USER1:[RDB_DATABASES]MF_AREA_REST.OPT  
" -
```

```
_$ DISK$USER1:[RDB_DATABASES]SLS_MF.RDB
```

Performing SLS Archiving Operations

This chapter describes the primary archiving features of SLS software. The following types of archiving methods are associated with SLS:

- Automatic archiving—files are moved according to access and time criteria
- Standby archiving—files are moved upon user request

The following sections describe these types of archiving methods.

9.1 Automatic Archiving

The SLS automatic archiving feature enables the storage administrator to move files that have remained inactive for a specified period of time from disk to near-line or off-line storage.

9.1.1 Preparing for Automatic Archiving

Before you can use the automatic archiving feature, you must make preparations that involve setting file retention and expiration times, and setting up the file that controls automatic archiving.

Table 9–1 Preparing for Automatic Archiving

Stage	Action
1.	Prepare your disk volumes by setting retention times for files on the volume with the SET VOLUME/RETENTION command.
2.	Because files might already exist on the disk volume, set the file expiration times for all files on the device with the SET FILE/EXPIRATION command.
3.	Implement your automatic archiving by making required entries and editing default assignments in the command file SLSSYSBAK:ARCHIVE SBK.COM.

9.1.2 Setting File Retention and Expiration Times

Automatic archiving moves files that have not been accessed for a specified period of time from disk to near-line or off-line storage. Before implementing automatic archiving, you must:

- Set volume retention time so that all new files will automatically be assigned an expiration date
- Explicitly set file expiration dates for files existing when volume retention time was first set

Definition: File Retention Time

The file retention time is a span of time assigned to a file that:

- Establishes a file's expiration date
- Provides a window within which access to the file causes a new expiration date to be calculated

Performing SLS Archiving Operations

9.1 Automatic Archiving

Note

Files without an explicitly defined expiration date are considered to have expired on 17-NOV-1858.

9.1.2.1 How the File Retention Time Works

Files created on a volume for which volume retention times have been enabled are automatically assigned expiration dates. The initial expiration date assigned when the file is created is set to the current time plus the value of the MAX parameter (specified with the DCL command SET VOLUME /RETENTION.) If the file is never opened, the expiration time does not change. The file is considered to be expired if the current date is after the expiration date.

Each time the file is opened, the value of the MIN parameter (specified with the DCL command SET VOLUME /RETENTION) is added to the current time. If the sum of this value is greater than the current expiration date, the file is assigned this value as the new expiration date.

9.1.2.2 A Graphic Look at File Retention Times

Figure 9–1 shows the effect of file retention times on a file's expiration date.

Figure 9–1 File Retention Times

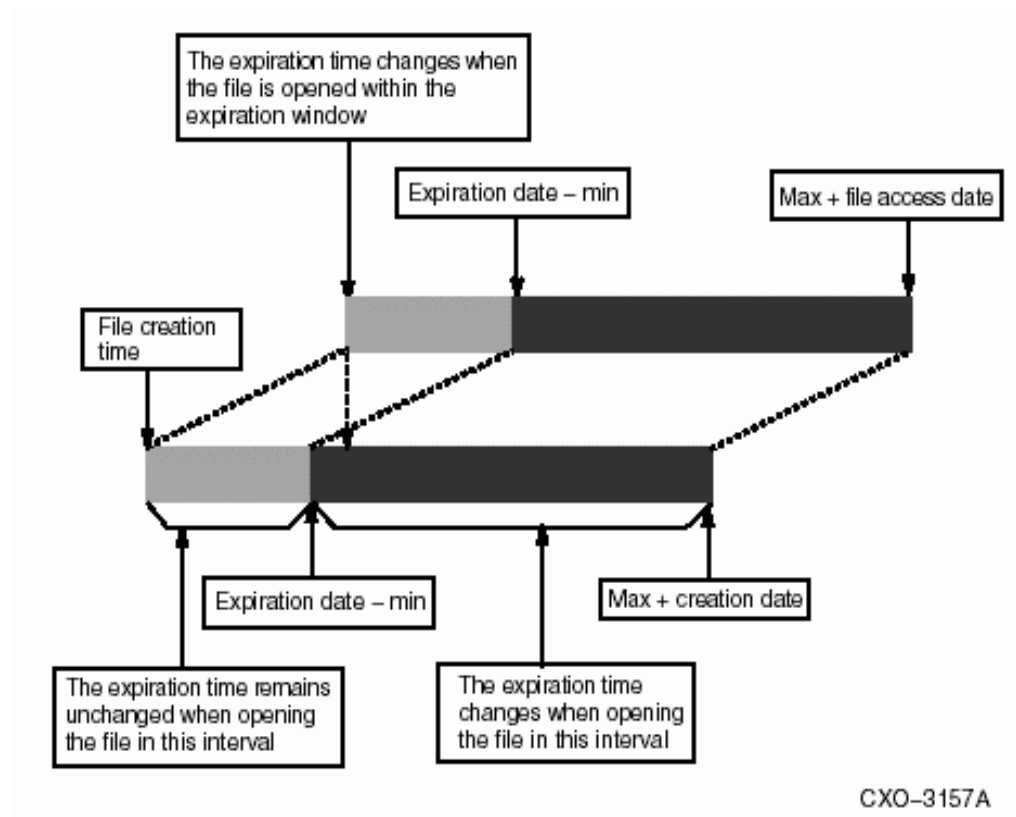

9.1.2.3 Special Cases of File Access

File access may or may not affect the file retention time. Consider the following special cases:

Access affecting file retention:

Performing SLS Archiving Operations

9.1 Automatic Archiving

- Running an executable image (an .EXE file) is the same as reading the file and changes the expiration date.
- Changing a file's header, such as executing a SET FILE /OWNER command, is the same as reading the file and changes the expiration date.

Access not affecting file retention:

Saving or moving files with the VMS Backup utility does not change the expiration date.

9.1.2.4 Rules for Applying the File Retention Time with the SET VOLUME Command

Follow these rules for applying a file retention time with the DCL command SET VOLUME/RETENTION:

- Set the file retention time only once on a disk volume. This can be done any time, even after the disk volume has been initialized.
- The file retention time does not affect files currently on the volume, but only affects newly created files or files accessed after the file retention times have been enabled.

9.1.2.5 How to Set the File Retention Time

The file retention time requires two values representing a number of days. Set the file retention time with the following DCL command.

```
SET VOLUME/RETENTION=(min,max)
```

Min:

Specifies the minimum amount of time to determine the expiration date.

Max:

Specifies the maximum amount of time to determine the expiration date. When setting file retention, the max value is optional; if it is not entered, the maximum time used is the smaller value of either:

- Two times the value of min
- The value of min plus seven days

Example:

To set minimum and maximum values of 60 and 90 days on a volume named DUA1: that contains two files named HICORY.DOC and DICORY.DOC, enter the following command:

```
$ SET VOLUME/RETENTION=(60-,90-) DUA1:
```

Before 30 days pass:

The file HICORY.DOC is opened and read several times, but the expiration date remains unchanged.

After 30 days pass:

The file HICORY.DOC is opened and read, but the expiration date is now changed and a new expiration date is computed based on the current day.

After 90 days pass:

The file DICORY.DOC expires and is eligible for SLS automatic archiving. The file HICORY.DOC remains with a later expiration date.

Performing SLS Archiving Operations

9.1 Automatic Archiving

9.1.2.6 How to Set Expiration Times for Files

On a disk volume where file retention is set for the first time, the existing files have no expiration date.

Recommendation:

After invoking the SET VOLUME/RETENTION command, set the expiration dates on all existing files.

Note

Depending on the number of files and the amount of file activity, this command may take from several seconds to many hours to complete.

Example:

Existing files become candidates for automatic archiving 90 days after the following command is executed:

```
$ SET FILE /EXPIRE="90-" DUA2:[...]*.*;*
```

9.1.2.7 How to Determine a File's Expiration Date

Enter the DCL DIRECTORY command to determine a file's expiration date.

Example 1:

```
$ DIRECTORY/FULL filename.type
```

Example 2:

```
$ DIRECTORY/DATE=EXPIRED
```

Example 3:

```
$ DIRECTORY/EXPIRED/SINCE=date
```

9.1.3 Controlling Automatic Archiving

Automatic archiving is performed by SLS software as a system backup operation with a special system backup command file.

This section describes how to control automatic archiving with the SLSSSYS-BAK:ARCHIVE_SBK.COM system backup command file.

Note

Do not tailor the ARCHIVE_SBK.COM file if you are performing standby archiving only at your site.

Automatic Archiving Symbols

Table 9–2 lists the automatic archiving symbols, their default assignments and the purpose for each symbol.

Table 9–2 Automatic Archiving Symbols in ARCHIVE_SBK.COM

Symbol and default assignment	Purpose
DAYS_1 ::= FRIDAY	Performs the archive operation every Friday.
TIME_1 ::= 08:30	Performs archiving at 8:30 am.

Performing SLS Archiving Operations 9.1 Automatic Archiving

Table 9–2 Automatic Archiving Symbols in ARCHIVE_SBK.COM

Symbol and default assignment	Purpose
NODE_1 ::=	Specifies the node. Required action: You must customize this assignment.
FILES_1 ::= \$DISK1:[USER...]	Specifies the disk to scan for automatic archive candidates.
PROGRESS ::= 0	Suppresses progress reporting.
QUALIFIERS == "VER- IFY/EXPIRE/" - "BEFORE=TODAY/DELETE/EXCLUDE= (* .MAI)'	Verifies the backup operation, selects expired files, and deletes them from the disk (excluding any .MAI files).
PRIVS ::= BYPASS	Executes the archive operation with the ability to bypass all file protection on any files.
SAVESET_GEN ::= "DO_DISK + " ".ARC"	Generates the save set name includes the device name with an extension of .ARC.
HISTORY_SET ::= ARCHIVE	Records the backup operation in the SLS ARCHIVE history file set.
SBUPDT_Q ::=SY\$BATCH	Names the queue that executes archive operation.
LISTING_GEN == -" " "SLS\$SYS- BAK:ARCHIVE" " + DO_DISK"	Names the listing file after the disk device.
FULL ::= 1	Specifies the listing file to contain all information.
PRINT_Q ::=SY\$PRINT	Prints the listing file on the SY\$PRINT queue.
AUTOSEL ::= 1	Enables SLS software to automatically choose volumes.
TAPE_POOL ::= ARCHIVE	Specifies that volumes come from the ARCHIVE pool only.
REEL_SIZE ::= 2400	Specifies 2400 foot tape reels
NOTES ::=ARCHIVE SYSTEM BACKUP	Writes "ARCHIVE SYSTEM BACKUP" in the notes field in each volume record.
SCRATCH_DAYS ::=	Specifies that volumes allocated during automatic archiving operations are retained indefinitely.
CONTINUE ::= ARCS	Causes all automatic archiving operations to share the same volume(s).
ON SITE_DATE ::=	Does not process for off-site storage.
OFFSITE_DATE ::=	
MEDIA_TYPE ::= 9TRACK	Specifies 9-track media for the archive operation.
N_DRIVES ::= 1	Specifies the archive operation to use only one drive.
STATUS_MAIL ::= SYSTEM	Reports status by mail to the system console.
LOG_FILE ::=	Names the log file produced by the archive operation. Required action: You must make an assignment to this symbol.

Table 9–2 Automatic Archiving Symbols in ARCHIVE_SBK.COM

Symbol and default assignment	Purpose
DRIVE_TYPE :=	Specifies the drive type if you want to override the drives normally selected for the indicated density.
CONTLOADOPT == 2	Enables the operator to override a volume label mismatch.
TAPE_LABELS == 2	Prints volume labels when the archive operation complete.
MNTFLAGS == 0	Defaults to the normal system mount operation.
NEXT_JOB :=	Automatic archive operation is complete when ARCHIVE_SBK.COM execution is complete.
PREALLOC := 0	Does not preallocate volumes for the archive operation.

The symbols used in the ARCHIVE_SBK.COM file for automatic archiving are the same found in the SYSDSK.TEMPLATE file. For detailed information about any of these symbols, refer to Appendix A.

9.2 Standby Archiving

The SLS standby archiving feature allows users to archive their own files. Standby archiving runs as a detached process called STANDBY_ARCHIVE. The process enables a user to write files to a private save set designated by the archive class. This save set is written to volumes mounted on drives dedicated to the standby archive process. Private save sets are owned by the users, but the volume is owned by SLS.

A standby archive process runs for a period of time during which the operator enables SLS software to write all user archive requests for a specified archive class to a SLS- owned volume. Standby archive processes are controlled by the storage administrator through the Operator Menu.

While a standby archive process is active it:

- Runs as a detached process named STANDBY_ARCHIVE
- Periodically searches for save requests designated for a specific archive class and then executes those save requests

Requirement

Standby archiving requires a dedicated drive for the duration of the current standby archiving process.

Restrictions

The following restrictions apply to standby archiving:

- Standby archiving is restricted to running one standby archiving process at a time.
- You cannot preallocate volumes or volume sets to use for the standby archive process.
- The standby archive process starts with the last volume in a set, not with the specified volume, or even the first volume in the set. If you need to use a volume in a volume set, then make it the last volume in the set.

Example:

Performing SLS Archiving Operations

9.2 Standby Archiving

Use the following STORAGE SPLIT command to make a volume the last volume in a volume set:

```
$ STORAGE SPLIT VOL03  
  
$ STORAGE APPEND VOL03/VOL04
```

Refer to the STORAGE SPLIT command in the Media and Device Management Services for OpenVMS Guide to Operations for complete instructions about using the STORAGE SPLIT command.

9.2.1 Advantages of Standby Archiving

Standby archiving offers the following advantages:

- Performs save operations on media without constant operator intervention. These save operations can include general user backups for file protection or archiving for long-term storage.
- Provides a consistent method of saving information to one central and predetermined location. Standby archiving is not restricted to archive operations only; any save operation can be performed using this feature.

Disadvantage:

You cannot perform a restore operation as a direct result of a standby archiving save request. That is, you cannot immediately restore a file that is saved on a drive dedicated to a standby archiving process. You can either wait until the volume receiving save requests fills to capacity and returns to the volume database, or contact your storage administrator to restore the specified file immediately.

9.2.2 How Standby Archiving Works

Table 9–3 The Standby Archiving Process

Stage	Action
1.	The storage administrator assigns values to the symbols in the SY\$MANAGER:TAPE-START.COM file that control standby archiving. (See Section 9.2.5).
2.	The storage administrator establishes archive classes and enables user access to these classes by modifying the B1C.TEMPLATE file (Section 9.2.7): Use the Authorize Class Access for a User option of the Standby Archive option of the Operator Menu Use your favorite editor Archive class: An Archive class defines the characteristics of the data that is archived in that archive class.
3.	The storage administrator establishes the standby archiving interval. (See Section 9.2.5.2). Periodically, the SLS standby archive process runs and executes the save requests that users have created since the last standby archive operation was executed.
4.	Users specify files to save into the archive classes that they are allowed to access. (See Section 9.2.8).

Performing SLS Archiving Operations

9.2 Standby Archiving

9.2.3 How Standby Archiving Executes Save Requests

The following steps take place when a user creates a save request and specifies an archive class name designated for standby archiving:

1. A user creates a save request that specifies an archive class name (see your storage administrator for valid archive class names).
2. The request generates a file with the extension of .ARKIVE. This file resides in the SLSS\$DATA directory.
3. The SLS software sends the save request to the standby archiving queue to wait with other save requests.
4. The queued save request executes when the operator starts a standby archiving process for that archive class. (For scheduling, see your storage administrator.)
5. The SLS software sends a mail message to notify the user when the save request for standby archiving has completed.

9.2.4 How Standby Archiving Uses .ARKIVE Files

The standby archive process periodically checks the directory SLSS\$DATAC for any files with the extension of .ARKIVE. When the standby archive process locates a save request designated for the currently active archive class, it executes the save request.

The following process describes how .ARKIVE files are created and how the standby archive process uses them:

1. An .ARKIVE file is created when a save request is created using the Save Screen menu option.
2. The user specifies the Volume ID as "ARCHIVE" and then enters the archive class name in the NOTES field.
3. Newly created .ARKIVE files are placed in the SLSS\$DATAC directory.
4. The .ARKIVE files that are created first are executed first.

9.2.5 Editing TAPESTART.COM for Standby Archiving

This section describes the symbols in the file SYSS\$MANAGER:TAPESTART.COM that control the standby archiving process.

9.2.5.1 Defining Standby Archiving Log File Location

Assign the location for the standby archiving job's log file to the SBARLOG symbol.

Example:

An example assignment is:

```
$ SBARLOG := SLSS$DATA:STANDBY_ARCHIVE.LOG;
```

For no log file:

If you do not want to create log files, do not make an assignment to the symbol.

9.2.5.2 Setting the Standby Archiving Interval

Determine the interval that SLS software checks for standby archiving requests. Assign a time value for the interval to the SBARINT symbol.

Required format:

The format for the assignment must be in hours, minutes, and seconds separated by colons.

Example:

If you want to set the interval for 30 seconds, assign:

```
$ SBARINT := 00:00:30
```

9.2.5.3 Defining the Default Archive Class

Assign the name of the default archive class to the SBACLAS symbol. The name used in this assignment is provided as the default in the User Menu Save Screen option.

System-wide name:

SLS software equates the system-wide logical name SLS\$DEFSBACCLASS to the string assigned to the SBACLAS symbol.

Example:

To define the default archive class named FOREVER, assign the following:

```
$ SBACLAS = "FOREVER"
```

9.2.5.4 Alternate Methods for Defining the Default Archive Class

There are two other methods that can be used to define the default archiving class. These are:

- Define the SLS\$DEFSBACCLASS logical to the default archiving class in the SYS\$LOGIN.COM file
- Make a customized copy of the TAPSYMBOL.COM file to set up a class based on the user name

9.2.6 Standby Archive Operator Menu Option

Description

The Standby Archive Menu provides a path for performing standby archiving tasks, such as starting up, shutting down, and controlling SLS standby archiving operations.

Standby Archive Menu Screen Display

Performing SLS Archiving Operations

9.2 Standby Archiving

Figure 9–2 illustrates the Standby Archive Menu.

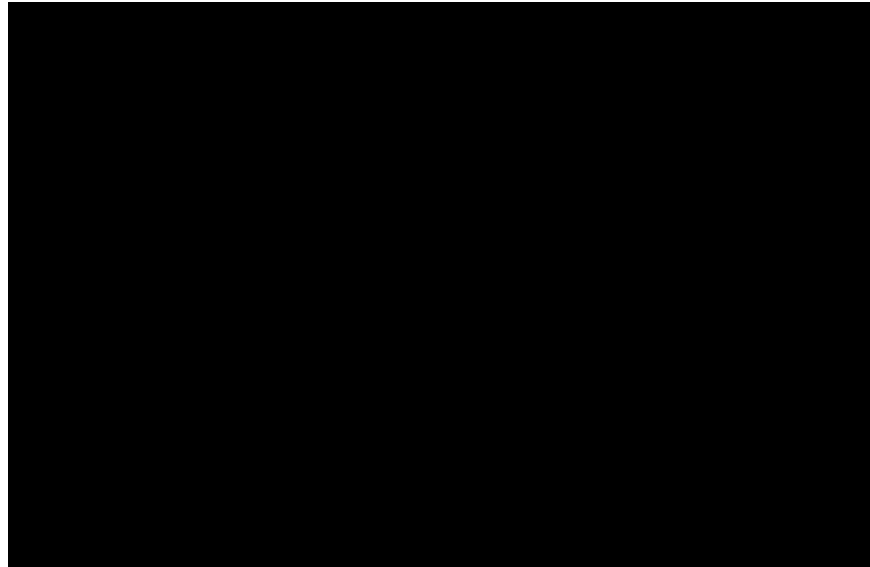

Procedure

Perform the steps in Table 9–4 to access the Standby Archive Menu.

Requirement:

Using the Standby Archive Menu option requires the following privileges:

- WORLD
- SYSPRV
- OPER

Table 9–4 How to Access the Standby Archive Menu

Step	Action
1.	Enter 13 from the Operator Menu and press <Return>. Result: The software displays the Standby Archive Menu.
2.	Enter the number next to the desired option and press <Return>. Result: The software displays the requested screen.
3.	Press keypad period < . > or <Return> to exit the menu.

9.2.6.1 Standby Archive Menu Options

Table 9–5 lists the Standby Archive Menu options.

Table 9–5 Options for Standby Archive Menu

Option	Function
1. Start Up Standby Archiving	Starts up standby archiving. Refer to Section 9.2.6.4 for instructions about using this option
2. Shutdown Standby Archiving	Shuts down standby archiving when the current process has completed. Refer to Section 9.2.6.5 for instructions about using this option.
3. Inquire Pending Jobs	Shows jobs waiting to be started in the standby archiving queue. Refer to Section 9.2.6.6 for instructions about using this option.
4. Abort Standby Archiving	Shuts down the current active process of standby archiving. Refer to Section 9.2.6.7 for instructions about using this option.
5. Authorize Class Access for a User	Displays the B1C.TEMPLATE used to define archive classes and the user names assigned to those classes. Refer to Section 9.2.7.2 for instructions about using this option.

9.2.6.2 Starting Up and Shutting Down the Standby Archiving Process

There are two ways to start and stop the standby archiving process:

1. Using the Standby Archive option of the Operator Menu
2. Using the STORAGE STARTUP command

The Standby Archive Option

The Standby Archive option on the Operator Menu provides a menu from which you can start up (Section 9.2.6.4) or shutdown (Section 9.2.6.5) standby archiving.

The STORAGE STARTUP Command

The STORAGE STARTUP command can be entered at the VMS prompt or written into a DCL command procedure to start and stop standby archiving.

Starting:

Use this command to startup standby archiving:

```
$ STORAGE STARTUP STANDBY_ARCHIVING vol_id init_option class_name
```

Where:

vol_id is the Volume ID of the volume to which the files will be written.

init_option is whether to initialize the volume. Use either:

YES to initialize

NO to not initialize

class_name is the archive class name (which indicates save set to use)

9.2.6.3 Before You Begin

Because the standby archive process is limited to running one process at a time, you must first determine:

Performing SLS Archiving Operations

9.2 Standby Archiving

- Which classes to run
- What order to run the classes

For each archive class, the standby archive process must be started, completed, and stopped or aborted before starting the next class.

9.2.6.4 Starting Up Standby Archive From the Operator Menu

Description

The Start Up Standby Archive option displays a screen that allows you to:

- Enter required data to a series of displayed prompts necessary to start up standby archiving
- Start a standby archive process to handle user save requests that are designated to a specific archive class

Standby Archive Screen Display

Figure 9–3 illustrates the Standby Archine Menu.

Figure 9–3 Standby Archive Menu.

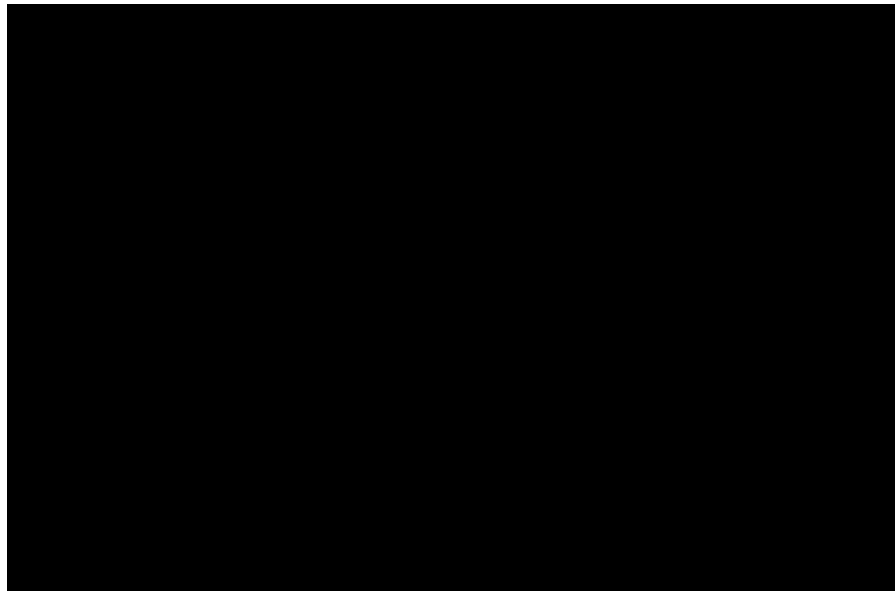

Procedure

Perform the steps described in Table 9–6 to use the Start Up Standby Archive menu option.

Table 9–6 Start Up Standby Archive

Step	System prompt	Action
1.	-	Enter 13 from the Operator Menu and press <Return>. <u>Result:</u> The software displays the Standby Archive Menu (Figure 9–2).

Table 9–6 Start Up Standby Archive

Step	System prompt	Action																
2.	-	Select option 1 from the Standby Archive menu and press <Return>. <p><u>Result:</u> The software displays the Start Up Standby Archive screen (Figure 9–2).</p>																
3.	Archiving class name (Enter ? for list):	Enter the archive class name for which you want to create an active standby archiving session: <p><u>Note:</u> If you need to see a list of available archive classes, press < ? >.</p>																
4.	Volume to use for class archive-class (NEW = new volume, press Return for Volume ID).	Choose one of the following: <table border="0" style="margin-left: 20px;"> <thead> <tr> <th style="text-align: left;">IF you want...</th> <th style="text-align: left;">THEN ...</th> </tr> </thead> <tbody> <tr> <td>To use the last volume used for standby archiving</td> <td>Press <Return>. <p><u>Result:</u> The Volume ID is displayed at the prompt. For example, if the last volume used was APR029, then the prompt displays:</p> <pre style="margin-left: 40px;">Volume to use for class archive class name (NEW = new volume, Press Return for APR029):</pre> </td> </tr> <tr> <td>To specify the Volume</td> <td>Enter the Volume ID to use for this archiving session and go to Step 5. <p><u>Requirements:</u> This volume must already be allocated to you.</p> </td> </tr> <tr> <td>The software to select and allocate a volume for you</td> <td>Enter NEW. <p><u>Result:</u> The software displays the following systme prompts.</p> <table border="0" style="margin-left: 20px;"> <thead> <tr> <th style="text-align: left;">Prompt</th> <th style="text-align: left;">Response</th> </tr> </thead> <tbody> <tr> <td>Media type:</td> <td>Enter the media type of the backup. volume.</td> </tr> <tr> <td>Pool name from which to allo-cated:</td> <td>Enter the pool name from which this volume is to be allocated.</td> </tr> <tr> <td>Scratch date for volume:</td> <td>Enter the scratch date for the volume.</td> </tr> </tbody> </table> </td> </tr> </tbody> </table> <p><u>Result:</u> The system displays a report on the specified volume.</p>	IF you want...	THEN ...	To use the last volume used for standby archiving	Press <Return>. <p><u>Result:</u> The Volume ID is displayed at the prompt. For example, if the last volume used was APR029, then the prompt displays:</p> <pre style="margin-left: 40px;">Volume to use for class archive class name (NEW = new volume, Press Return for APR029):</pre>	To specify the Volume	Enter the Volume ID to use for this archiving session and go to Step 5. <p><u>Requirements:</u> This volume must already be allocated to you.</p>	The software to select and allocate a volume for you	Enter NEW . <p><u>Result:</u> The software displays the following systme prompts.</p> <table border="0" style="margin-left: 20px;"> <thead> <tr> <th style="text-align: left;">Prompt</th> <th style="text-align: left;">Response</th> </tr> </thead> <tbody> <tr> <td>Media type:</td> <td>Enter the media type of the backup. volume.</td> </tr> <tr> <td>Pool name from which to allo-cated:</td> <td>Enter the pool name from which this volume is to be allocated.</td> </tr> <tr> <td>Scratch date for volume:</td> <td>Enter the scratch date for the volume.</td> </tr> </tbody> </table>	Prompt	Response	Media type:	Enter the media type of the backup. volume.	Pool name from which to allo-cated:	Enter the pool name from which this volume is to be allocated.	Scratch date for volume:	Enter the scratch date for the volume.
IF you want...	THEN ...																	
To use the last volume used for standby archiving	Press <Return>. <p><u>Result:</u> The Volume ID is displayed at the prompt. For example, if the last volume used was APR029, then the prompt displays:</p> <pre style="margin-left: 40px;">Volume to use for class archive class name (NEW = new volume, Press Return for APR029):</pre>																	
To specify the Volume	Enter the Volume ID to use for this archiving session and go to Step 5. <p><u>Requirements:</u> This volume must already be allocated to you.</p>																	
The software to select and allocate a volume for you	Enter NEW . <p><u>Result:</u> The software displays the following systme prompts.</p> <table border="0" style="margin-left: 20px;"> <thead> <tr> <th style="text-align: left;">Prompt</th> <th style="text-align: left;">Response</th> </tr> </thead> <tbody> <tr> <td>Media type:</td> <td>Enter the media type of the backup. volume.</td> </tr> <tr> <td>Pool name from which to allo-cated:</td> <td>Enter the pool name from which this volume is to be allocated.</td> </tr> <tr> <td>Scratch date for volume:</td> <td>Enter the scratch date for the volume.</td> </tr> </tbody> </table>	Prompt	Response	Media type:	Enter the media type of the backup. volume.	Pool name from which to allo-cated:	Enter the pool name from which this volume is to be allocated.	Scratch date for volume:	Enter the scratch date for the volume.									
Prompt	Response																	
Media type:	Enter the media type of the backup. volume.																	
Pool name from which to allo-cated:	Enter the pool name from which this volume is to be allocated.																	
Scratch date for volume:	Enter the scratch date for the volume.																	
5.	-	If you entered a Volume ID, then respond to the following prompts.																

Performing SLS Archiving Operations

9.2 Standby Archiving

Table 9–6 Start Up Standby Archive

Step	System prompt	Action																
		<table border="1"> <thead> <tr> <th>Prompt</th> <th>IF ...</th> <th>THEN ...</th> <th>ELSE ...</th> </tr> </thead> <tbody> <tr> <td>Initialize volumes <i>volume-id</i> (YES or NO ?)</td> <td>The volume should be initialized before starting standby archive</td> <td>Enter YES</td> <td>Enter NO.</td> </tr> <tr> <td>Request scan interval [00:00:30]</td> <td>You want to use the default</td> <td>Press <Return></td> <td>Enter the scan interval using the indicated format.</td> </tr> <tr> <td>OK to proceed [Y]?</td> <td>The information entered is correct</td> <td>Enter Y and press <Return> Result: Starts a process to scan for user requests in the specified archive class and returns you to the main Standby Archive Menu.</td> <td>Enter NO. Result: Returns you to the first system prompt.</td> </tr> </tbody> </table>	Prompt	IF ...	THEN ...	ELSE ...	Initialize volumes <i>volume-id</i> (YES or NO ?)	The volume should be initialized before starting standby archive	Enter YES	Enter NO .	Request scan interval [00:00:30]	You want to use the default	Press <Return>	Enter the scan interval using the indicated format.	OK to proceed [Y]?	The information entered is correct	Enter Y and press <Return> Result: Starts a process to scan for user requests in the specified archive class and returns you to the main Standby Archive Menu.	Enter NO . Result: Returns you to the first system prompt.
Prompt	IF ...	THEN ...	ELSE ...															
Initialize volumes <i>volume-id</i> (YES or NO ?)	The volume should be initialized before starting standby archive	Enter YES	Enter NO .															
Request scan interval [00:00:30]	You want to use the default	Press <Return>	Enter the scan interval using the indicated format.															
OK to proceed [Y]?	The information entered is correct	Enter Y and press <Return> Result: Starts a process to scan for user requests in the specified archive class and returns you to the main Standby Archive Menu.	Enter NO . Result: Returns you to the first system prompt.															

9.2.6.5 Shutting Down Standby Archive From the Operator Menu

Description

The Shutdown Standby Archive option displays a screen that allows you to stop the current standby archive process **after** it completes.

Shutdown Standby Archive Screen Display

Figure 9–4 illustrates the screen digram only if standby archive is not running.

Figure 9–4 Shutdown Standby Archive

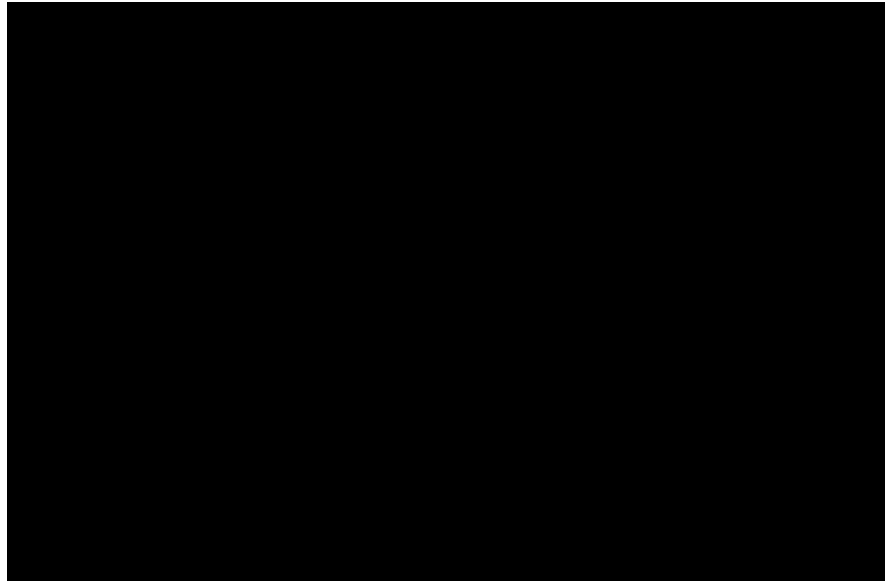

Procedure

Perform the steps described in Table 9–7 to use the Shutdown Standby Archive menu option.

Table 9–7 Shutdown Standby Archive

Step	Action						
1.	Enter 13 from the Operator Menu and press <Return>. <u>Result:</u> The software displays the Standby Archive Menu (Figure 9–2). Enter 2 from the Standby Archive Menu and press <Return>.						
2.	Enter 2 from the Standby Archive Menu and press <Return>.						
	<table border="0"> <tr> <td style="vertical-align: top;">IF ...</td> <td style="vertical-align: top;">THEN ...</td> </tr> <tr> <td style="vertical-align: top;">Standby archive is running.</td> <td style="vertical-align: top;">No reply is necessary. <u>Result:</u> The SLS software initiates a batch process that shuts down the standby archive process in an orderly fashion.</td> </tr> <tr> <td style="vertical-align: top;">Standby archive is not running.</td> <td style="vertical-align: top;">The software displays a screen stating standby archive is not running (Figure 9–4).</td> </tr> </table>	IF ...	THEN ...	Standby archive is running.	No reply is necessary. <u>Result:</u> The SLS software initiates a batch process that shuts down the standby archive process in an orderly fashion.	Standby archive is not running.	The software displays a screen stating standby archive is not running (Figure 9–4).
IF ...	THEN ...						
Standby archive is running.	No reply is necessary. <u>Result:</u> The SLS software initiates a batch process that shuts down the standby archive process in an orderly fashion.						
Standby archive is not running.	The software displays a screen stating standby archive is not running (Figure 9–4).						

9.2.6.6 Inquire Pending Jobs From the Operator Menu

Description

The Inquire Pending Jobs option allows you to display the current save requests waiting to be executed by the standby archiving process.

Performing SLS Archiving Operations

9.2 Standby Archiving

Inquire Pending Jobs Screen Display

Figure 9–5 illustrates the Inquire Pending Jobs screen display.

Figure 9–5 Inquire Pending Jobs

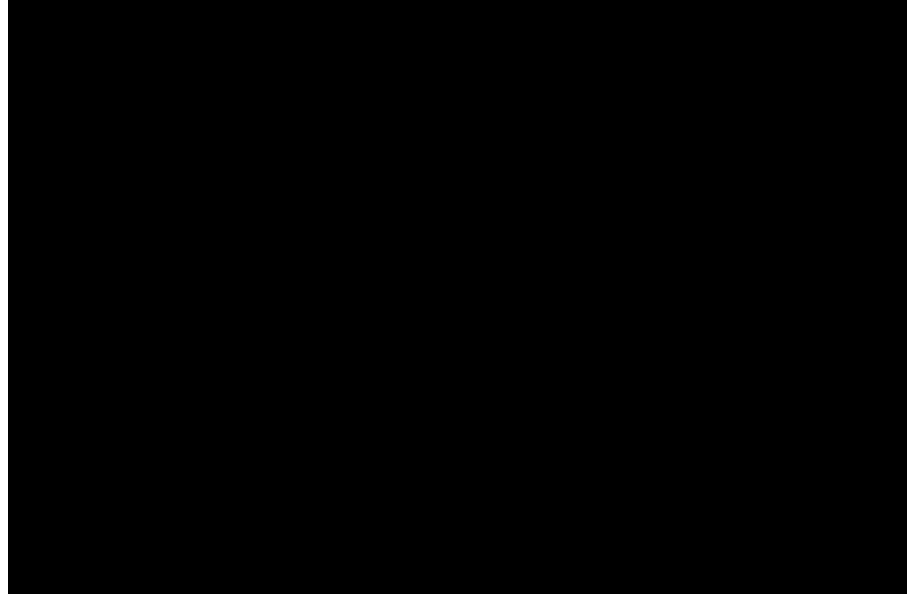

Procedure

Perform the steps described in Table 9–8 to use the Inquire Pending Jobs Standby Archive menu option.

Table 9–8 Inquire Pending Jobs

Step	Action
1.	Enter 13 from the Operator Menu and press <Return>. <u>Result:</u> The software displays the Standby Archive Menu (Figure 9–2).
2.	Enter 3 from the Standby Archive Menu and press <Return>. <u>Result:</u> The software displays a report about the current jobs waiting for standby archiving in the Inquire Pending Jobs screen (Figure 9–5).

9.2.6.7 Aborting Standby Archive

Description

The Abort Standby Archive option displays a screen that allows you to stop the current standby archive process without waiting for it to complete.

Procedure

Perform the steps described in Table 9–9 to use the Abort Standby Archive Menu option.

Table 9–9 Abort Standby Archive

Step	Action
1.	Enter 13 from the Operator Menu and press <Return>. Result: The software displays the Standby Archive Menu (Figure 9–2).
2.	Enter 4 from the Standby Archive Menu and press <Return>. Result:
	IF ...
	Standby archive is running.
	Standby archive is not running.
	THEN ...
	No reply is necessary. <u>Result:</u> The SLS software immediately stops the standby archive process.
	The software displays a screen stating standby archive is not running_(Figure 9–4).

9.2.6.8 How to Interrupt the Standby Archive Process

Interrupting the standby archive process may sometimes be necessary. Use one of the following methods to interrupt the standby archive process:

- If the .ARKIVE file has not started processing, then delete the .ARKIVE files.
- If the .ARKIVE file has started processing, then abort the standby archive process (Section 9.2.6.7).

9.2.7 Establishing Archive Classes and Enabling User Access

SLS uses the SLS\$PARAMS:B1C.TEMPLATE file to establish archive classes and enable user access to them. By understanding how this file is processed, you will be able to enable, assign, and disable archive classes and enable user access to those archive classes.

Because the B1C.TEMPLATE file is executed in sequence from top to bottom, the commands are used to enable, assign, then disable access to archive classes. The storage administrator is responsible for editing and maintaining the B1C.TEMPLATE file.

See Section 9.2.7.2 for instructions to create archive classes and enable user access.

9.2.7.1 Archive Class Naming Conventions

There are two conventions recommended for naming archive classes. Names that indicate:

1. How long data will be retained

For example:

1YEAR

5YEAR

FOREVER

2. Data classification:

For example:

ACCOUNTS

Performing SLS Archiving Operations

9.2 Standby Archiving

MAPPUBS

PRGMDOCS

9.2.7.2 Authorizing Class Access For a User From The Operator Menu

Description

The Authorize Class Access for a User option displays a screen that allows you to:

- Define the classes that can be specified by a user when requesting files to be saved to a standby archive volume
- Edit the file named B1C.TEMPLATE, located in SLSSPARAMS (SLSSPARAMS:B1C.TEMPLATE).

The B1C.TEMPLATE file includes:

- Instructions and examples for entering archive classes and authorizing user names
- The commands necessary to perform the authorizations

Standby Archive Parameters

There are four standby archiving parameters located at the bottom of the B1C.TEMPLATE file. These parameters are used to create, add, remove, and authorize classes and user names. They are:

- **ADD_CLASS** *archive_class_name*-Adds an archive class name.
- **REMOVE_CLASS** *archive_class_name*-Invalidates a class for the next list of user names.
- **WRITE_DEFAULT** *archive_class_name*-Enters the default archive class.
- **WRITE_USER** *user_name*-Authorizes user names for defined archive classes.

Refer to Table 9–10 to implement these parameters.

Authorize Class Access For a User Screen Display

Figure 9–6 illustrates the B1C.TEMPLATE file used to establish archive classes and authorized user access to those archive classes.

Procedure

Perform the steps described in Table 9–10 to use the Authorize Class Access for a User menu option.

Figure 9–6 B1C.TEMPLATE

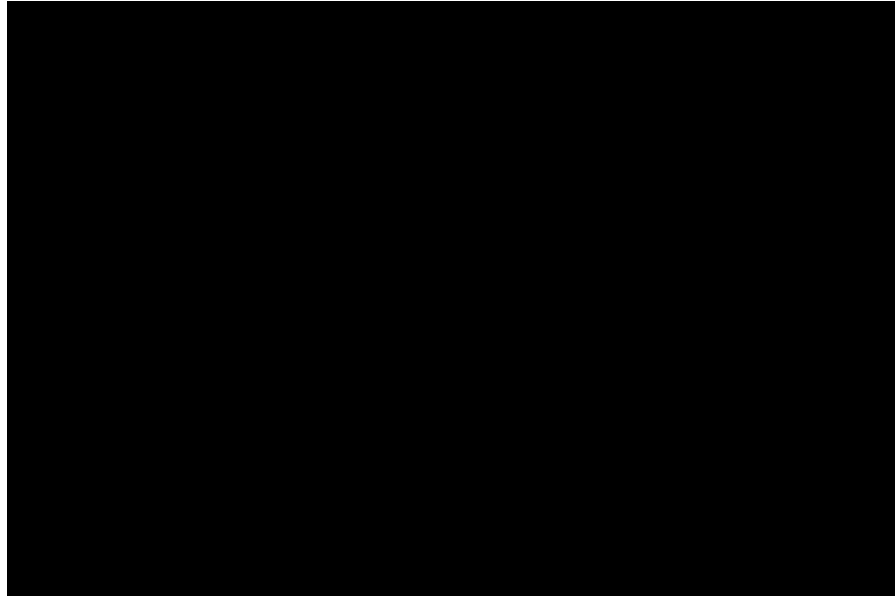

Table 9–10 How to Authorize Class Access for a User

Step	Action						
1.	Enter 13 from the Operator Menu and press <Return>. <u>Result:</u> The software displays the Standby Archive Menu (Figure 9–2).						
2.	Enter 5 from the Standby Archive Menu and press <Return>. <u>Result:</u> The software displays the B1C.TEMPLATE file (Figure 9–6).						
3.	<u>Restriction:</u> Enter only one command per line.						
	<table border="0"> <thead> <tr> <th>IF you want to ...</th> <th>THEN ...</th> </tr> </thead> <tbody> <tr> <td>Add an archive class</td> <td>Enter the command: <code>ADD_CLASS archive_class_name</code> <u>Result:</u> Creates and adds an archive class to the database. This archive class becomes valid for all users identified with <code>WRITE_USER user_name</code> following this entry.</td> </tr> <tr> <td>Remove an archive class.</td> <td>Enter the command: <code>REMOVE_CLASS archive_class_name</code> <u>Result:</u> Invalidates all user names following the <code>REMOVE_CLASS archive_class</code>. This class remains valid for user names that precede it in the list.</td> </tr> </tbody> </table>	IF you want to ...	THEN ...	Add an archive class	Enter the command: <code>ADD_CLASS archive_class_name</code> <u>Result:</u> Creates and adds an archive class to the database. This archive class becomes valid for all users identified with <code>WRITE_USER user_name</code> following this entry.	Remove an archive class.	Enter the command: <code>REMOVE_CLASS archive_class_name</code> <u>Result:</u> Invalidates all user names following the <code>REMOVE_CLASS archive_class</code> . This class remains valid for user names that precede it in the list.
IF you want to ...	THEN ...						
Add an archive class	Enter the command: <code>ADD_CLASS archive_class_name</code> <u>Result:</u> Creates and adds an archive class to the database. This archive class becomes valid for all users identified with <code>WRITE_USER user_name</code> following this entry.						
Remove an archive class.	Enter the command: <code>REMOVE_CLASS archive_class_name</code> <u>Result:</u> Invalidates all user names following the <code>REMOVE_CLASS archive_class</code> . This class remains valid for user names that precede it in the list.						

Table 9–10 How to Authorize Class Access for a User

Step	Action
	<p>Define the default classes.</p> <p>Enter one or more archive classes to be allowed for all users on the system using the ADD_CLASS command, followed by the WRITE_DEFAULT command.</p> <p><u>Special consideration:</u> If you have many people in your organization and most of them require access to an archive class, put that archive class at the top of the file and enable users with WRITE_DEFAULT. Then, assign the special cases with ADD_USER, DELETE_USER, and WRITE_CLASS as needed.</p>
	<p>Authorize classes for user names.</p> <p>Enter the command: WRITE_USERNAME <i>user_name</i></p> <p><u>Result:</u> All archive classes that precede a user name are valid for that user unless the archive class is removed with REMOVE_CLASS.</p>
	<p>Exit the B!C.TEMPLATE file.</p> <ol style="list-style-type: none">1. Press <PF1> and keypad <7>. <u>Result:</u> The system prompts you to enter a command.2. Enter EXIT and press <Enter>. <u>Result:</u> The software displays the message “Update Complete” and prompts you to press Return to continue.

Example: B!C.TEMPLATE File

This example is taken from the supplied B!C.TEMPLATE file.

```
1. ADD_CLASS CL_1
2. WRITE_DEFAULT
3. ADD_CLASS CL_2
   ADD_CLASS CL_3
   ADD_CLASS CL_4
4. WRITE_USER USER_A
   WRITE_USER USER_B
5. REMOVE_CLASS CL_4
6. ADD_CLASS CL_5
7. WRITE_USER USER_C
   WRITE_USER USER_D
```

1.	The archive class CL_1 is enabled.
2.	The archive class CL_1, while enabled, is assigned as the default archive class for users. <u>Restriction:</u> The WRITE_DEFAULT command may be issued only one_time in the B!C.TEMPLATE file.

-
3. The archive classes CL_2, CL_3, and CL_4 are enabled.
 4. Users USER_A and USER_B are enabled access to the classes CL_1, CL_2, CL_3, and CL_4 (which are enabled).
 5. The archive class CL_4 is disabled for further user access.
 6. The archive class CL_5 is enabled.
 7. Users USER_C and USER_D are assigned access to the enabled classes CL_1, CL_2, CL_3, and CL_5.
-

Note:

Users USER_C and USER_D do not have access to archive class CL_4, which was disabled in Step 5.

9.2.8 Performing Save Operations Using Standby Archiving

You can perform a save operation using standby archiving using one of two methods:

1. User Menu Save Screen option (Section 9.2.8.1)
2. STORAGE SAVE command at the DCL prompt (Section 9.2.8.2).

9.2.8.1 Standby Archiving Performed From the User Menu Save Screen

To perform a save operation through standby archiving using the menu and screen option, follow the procedure in Table 9–11.

Table 9–11 Creating a User Save Request For Standby Archiving

Step	Action
1.	Display the User Menu.
2.	Select option 1, Save Screen, from the User Menu.
3.	Enter the files to be saved in ASCII or BACKUP format, not in EBCDIC format.
4.	Type the word ARCHIVE in the Volume ID field.
5.	Enter the archive class in the Media Notes field. The archive class must be the first word in this field. <u>Note:</u> Contact your storage administrator to see what classes are set up for your site before you perform a save operation using standby archiving.
6.	Press <Return> to submit your save request.

9.2.8.2 Standby Archiving Performed Using DCL

To save a file or save set through standby archiving, use the following format at the DCL (\$) prompt:

```
$ SAVE file-spec/VOLUME=ARCHIVE/NOTES="archive-class-name"
```

Generating SLS Reports

This chapter contains information about generating reports.

The tasks in the following sections are performed by using either the Operator Menu or the User Menu. There are other reports available on the various menus; however, they are not detailed here. In addition, you can obtain various reports using the STORAGE REPORT command. For more information, see *Storage Library System for OpenVMS Command Reference Guide*.

10.1 Operator Menu: Inquire Pending Jobs

Description

The Inquire Pending Jobs option displays a screen that allows you to display any archive requests waiting in the queue. This display includes:

- Time of the request
- User name
- Archive class

Procedure

Perform the steps described in Table 10–1 to use the Inquire Pending Jobs menu option.

Table 10–1 Inquire Pending Jobs

Step	Action						
1.	Enter 13 from the Operator Menu and press Return. <u>Result:</u> The software displays the Standby Archive Menu.						
2.	Enter 3 from the Standby Archive Menu and press Return. <u>Result:</u>						
	<table border="1"> <thead> <tr> <th>IF...</th> <th>THEN...</th> </tr> </thead> <tbody> <tr> <td>There are no jobs waiting in the standby archive queue.</td> <td>The software displays the message: "No pending archive jobs."</td> </tr> <tr> <td>There are jobs currently waiting in the standby archive queue.</td> <td>The software displays the list of archive requests.</td> </tr> </tbody> </table>	IF...	THEN...	There are no jobs waiting in the standby archive queue.	The software displays the message: "No pending archive jobs."	There are jobs currently waiting in the standby archive queue.	The software displays the list of archive requests.
IF...	THEN...						
There are no jobs waiting in the standby archive queue.	The software displays the message: "No pending archive jobs."						
There are jobs currently waiting in the standby archive queue.	The software displays the list of archive requests.						

Generating SLS Reports

10.2 User Menu: Report of Files on User Backups

10.2 User Menu: Report of Files on User Backups

Description

The Report of Files on User Backups option displays a report on one or more files, save sets, or volumes for the user making the request.

User Interface

When this screen is first entered, only one prompt line is displayed. Additional prompt lines are displayed after data is entered for the first prompt.

How to move in the screen:

Press the Return key to:

- Move from one prompt line to the next
- Make the final request for the report

Procedure

Perform the following steps in Table 10–2 to use the Report of Files on User Backups option.

Table 10–2 Report of Files on User Backups

Step	System Prompt	Action
1.	-	Enter 10 from the User Menu and press Return. <u>Result:</u> The software displays the Report of Files on User Backups screen.
2.	Enter files (Q=Quit):	Enter the file names and press Return.
3.	Report output file	Enter the destination for the report and press Return. <u>Example for terminal output:</u> SYSS\$OUTPUT
4.	Save sets	Enter the name of the save set for the user backup and press Return.
5.	Volumes	Enter the name of the volumes for the user backup and press Return, or use the default value by pressing Return.
6.	Since date	Enter the date since the time the files were saved and press Return, or use the default value by pressing Return.
7.	Before date	Enter the date before the time the files were saved and press Return, or use the default value by pressing Return.
8.	-	Type Q and press Return to exit the menu.

10.3 User Menu: Report of Files on System Backups

Description

The Report of Files on System Backups option displays a report on one or more files saved during system backups for the user making the request.

User Interface

When this screen is first entered, only one prompt line is displayed. Additional prompt lines are displayed after data is entered for the first prompt.

Generating SLS Reports 10.3 User Menu: Report of Files on System

How to move in the screen:

Press Return to:

- Move from one prompt line to the next
- Make the final request for the report

Procedure

Perform the following steps in Table 10–3 to use the Report of Files on System Backups option.

Table 10–3 Report of Files on System Backups

Step	System Prompt	Action
1.	-	Enter 11 from the User Menu and press Return. <u>Result:</u> The software displays the Report of Files on System Backups screen.
2.	Enter files (Q=Quit):	Enter the file names and press Return. <u>Note:</u> Wildcard file specifications are allowed.
3.	Report output file	Enter the destination for the report and press Return. <u>Example for terminal output:</u> SYS\$OUTPUT
4.	History sets	Enter the name of the history set for the system backup and press Return.
5.	-	Type Q and press Return to exit the menu

System Backup Command File Quick-Reference

A.1 Symbols for System Backup Control

Table A–1 lists the symbols in the SYSBAK.TEMPLATE and DBSYSBAK.TEMPLATE files for system backup control, descriptions of their allowable assignments, and document references.

Table A–1 Symbols for System Backup Control

Symbol	Purpose	See . . .
DAYS_n	Name of day. <u>Example:</u> MONDAY Day offset from month. <u>Example:</u> MONTH + 1	Section 5.3.1.5
BACKUP_TYPE	Type of system backup. Valid values are: <ul style="list-style-type: none"> • VMSBACKUP • RMUBACKUP 	Section 8.4.3
TIME_n	Time in HH:MM format. <u>Example:</u> 17:00	Section 5.3.1.6
NODE_n	Node name of the system on which the system backup operation is to be queued.	Section 5.3.1.8
PRE_PROCESS_FIRST	The name of a batch job you want to execute once at the start of the system backup operation.	Section 5.3.3.1
PRE_PROCESS_EACH	The name of a batch job you want to execute once for each FILES_n symbol defined.	Section 5.3.3.1
POST_PROCESS_LAST	The name of a batch job you want to execute at the completion of the system backup operation for each FILES_n symbol defined.	Section 5.3.3.1
POST_PROCESS_EACH	The name of a batch job you want to execute after all FILES_n backup operations have completed.	Section 5.3.3.1
NEXT_JOB	The name of a batch job you want to execute immediately following this operation.	Section 5.3.3.3

System Backup Command File QuickReference

A.2 Symbols for System Backup Type

Table A–1 Symbols for System Backup Control

Symbol	Purpose	See . . .
SUMMARY_FILE	Specify summary file option: <ul style="list-style-type: none"> • No summary file \$ SUMMARY_FILE == 0 • Limited summary file \$ SUMMARY_FILE == 1 • Full summary file \$ SUMMARY_FILE == 2 	Section 5.5.2

A.2 Symbols for System Backup Type

Table A–2 lists the symbols in the SYSBAK.TEMPLATE file for system backup type, descriptions of their allowable assignments, and document references.

Table A–2 Symbols for System Backup Type

Symbol	Allowable assignments	See . . .
PRIVS	The privilege under which you want the system backup operation to run. <u>Caution:</u> Be aware of the implications of the READALL privilege.	Section 5.4.1.4
FILES_n	Directory and/or file names to be saved.	Section 5.4.1.1
QUALIFIERS	Default BACKUP qualifiers. <u>Restriction:</u> The QUALIFIERS symbol should not be changed in a system backup operation's preprocessing procedures. <u>Caution:</u> Do not use /REWIND, /NOREWIND, /LIST, or /FULL.	Section 5.4
QUALIFIERS_n	BACKUP qualifiers associated with a corresponding FILES_n symbol. <u>Note:</u> The assignments in QUALIFIERS_n overrides the assignments in QUALIFIERS. They are not appended together.	Section 5.4
MNTFLAGS	Mounting actions, assign: <ul style="list-style-type: none"> • Enable read-checks assign symbol \$ MNT-FLAGS == MNT\$M_READCHECK • Place a message in the log, assign symbol \$ MNTFLAGS == MNT\$M_MESSAGE • Enable write-checks assign symbol \$ MNT-FLAGS == MNT\$M_WRITECHECK • Enable write cache assign symbol \$ MNT-FLAGS == MNT\$M_TAPE_DATE_WRITE 	Section 5.4.1.5

System Backup Command File QuickReference

A.3 Symbols for System Backup Volume Characteristics

Table A–2 Symbols for System Backup Type

Symbol	Allowable assignments	See . . .
SAVESET_GEN	Symbols for constructing the name of your save set. File and device symbols including: <ul style="list-style-type: none"> • NODE • DO_DISK • DO_FILES • HSTDIR • TOPDIR • FNAME • FTYPE Time and sequence symbols including: <ul style="list-style-type: none"> • P1 • P2 • DAY • DAY3 • DOM • MONTH • MONTHN 	Section 5.4.1.7
PROTECTION	A protection string in the same syntax as the DCL SET FILE/PROTECTION command.	Section 5.4.1.9

A.3 Symbols for System Backup Volume Characteristics

Table A–3 lists the symbols in the SYSBAK.TEMPLATE file for system backup volume characteristics, descriptions of their allowable assignments, and document references.

Table A–3 Symbols for System Backup Volume Characteristics

Symbol	Allowable Assignments	See...
MEDIA_TYPE	The media type supported by the drive or drive type assigned to the DRIVE_TYPE symbol.	Section 5.4.2.1
DENSITY	The density supported by the drives identified by drive type.	Section 5.4.2.3
REEL_SIZE	The length, in feet, of the volume reel size.	Section 5.4.2.4
TAPE_POOL	The volume pool from which to take volumes.	Section 5.4.2.2

System Backup Command File QuickReference

A.4 Symbols for System Backup Operator Intervention

A.4 Symbols for System Backup Operator Intervention

Table A–4 lists the symbols in the SYSBAK.TEMPLATE file for system backup operator intervention, descriptions of their allowable assignments, and document references.

Table A–4 Symbols for System Backup Operator Intervention

Symbol	Allowable assignments	See . . .
QUICKLOAD	Acknowledges loaded volumes for mounting: <ul style="list-style-type: none">• Operator acknowledges loaded volumes, assign 0.• SLS loads volumes without operator acknowledgment, assign 1.	Section 5.4.3.4
PREALLOC	The number of volumes that are allocated the mid-night before running the system backup operation.	Section 5.4.3.5
AUTOSEL	Specifies to enable or disable automatic selection of volumes by SLS software: <ul style="list-style-type: none">• Enable assign 1.• Disable assign 0.	Section 5.4.3.6
CONTLOADOPT	Handles volume label inconsistencies: <ul style="list-style-type: none">• Matching requested and loaded volume labels required, assign 0.• Matching requested and loaded volume labels required, or• Uninitialized loaded volume can be confirmed, assign 1.• Mismatching requested and loaded volume labels can be confirmed, and• Uninitialized loaded volume can be confirmed, assign 2.	Section 5.4.3.9
IGNBLAN	Handles uninitialized volumes.	
UNATTENDED_BACKUPS	Identifies OPCOM response behavior for unattended backups. Valid values are: <ul style="list-style-type: none">• 0—Require the operator to respond to messages.• 1—Do not require the operator to respond to messages (continue automatically).	Section 5.4.3

A.5 Symbols for System Backup Resource Allocation

Table A–5 lists the symbols in the SYSBAK.TEMPLATE file for system backup resource allocation, descriptions of their allowable assignments, and document references.

Table A–5 Symbols for System Backup Resource Allocation

Symbols	Allowable assignments	See . . .
CONTINUE	A file name shared by certain other system backup command files that enable them to save data contiguously on the volume.	Section 5.4.4.1

A.6 Symbols for System Backup Volume Disposition

Table A–6 lists the symbols in the SYSBAK.TEMPLATE file for system backup volume disposition, descriptions of their allowable assignments, and document references.

Table A–6 Symbols for System Backup Volume Disposition

Symbol	Allowable assignments	See . . .
HISTORY_SET	The name of the SLS system history set for this system backup operation. VMS backup history files are not compatible with Oracle RMU backup history files. For Oracle RMU backups, make sure the history set specified is used only for database system backups.	Section 5.4.5.1
SBUPDT_Q	The name of the queue that processes the SLS system history file.	Section 5.4.5.3
SCRATCH_DAYS	The number of days you want to retain the volume after data is backed up.	Section 5.4.5.4
OFFSITE_DATE ONSITE_DATE	The date you want to send volumes off site. Specify: <ul style="list-style-type: none"> • No date, assign null string: \$ OFFSITE_DATE ::= \$ ONSITE_DATE ::= . • Specific date, assign date string: \$ OFFSITE_DATE ::= 01-DEC-1991 \$ ONSITE_DATE ::= 01-DEC-1992 • Offset days from backup operation date, assign days: \$ OFFSITE_DATE ::= "+30-" \$ ONSITE_DATE ::= "+60-" • System determined date, assign: \$ OFFSITE_DATE ::= \$TRLNM("SLS\$OFFSITE_DATE") \$ ONSITE_DATE ::= F\$TRLNM("SLS\$ONSITE_DATE") 	Section 5.4.5.5

System Backup Command File QuickReference

A.7 Symbols for System Backup Device Control

Table A–6 Symbols for System Backup Volume Disposition

Symbol	Allowable assignments	See . . .
TAPE_LABELS	Disable or enable printing of volume labels: <ul style="list-style-type: none">• Disable printing, assign 0.• Enable printing of volume labels as volumes are allocated, assign 1.• Enable printing of volume labels as the volumes are completely filled, assign 2.• Enable printing of volume labels when the system backup operation completes, assign 3.	Section 5.4.5.7
NOTES	Any string of additional information you want to record with the volume record.	Section 5.4.5.9

A.7 Symbols for System Backup Device Control

Table A–7 lists the symbols in the SYSBAK.TEMPLATE file for system backup device control, descriptions of their allowable assignments, and document references.

Table A–7 Symbols for System Backup Device Control

Symbol	Allowable assignments	See . . .
DRIVE_TYPE	The list of drives you want to devote to the system backup operation: <ul style="list-style-type: none">• Specific local drives, assign device names: \$ DRIVE_TYPE ::= MUA3:,MUA4:• Specific remote drives, assign remote device specifications: \$ DRIVE_TYPE ::= DENVER::TF857• Specific drives, assign device class: \$ DRIVE_TYPE ::= MU• No specific drive, assign a null string: \$ DRIVE_TYPE ::=	Section 5.4.6.1
N_DRIVES	The number of drives you want to devote to the system backup operation.	Section 5.4.6.2

A.8 Symbols for System Backup Status and Information

Table A–8 lists the symbols in the SYSBAK.TEMPLATE file for system backup status and information, descriptions of their allowable assignments, and document references.

Table A–8 Symbols for System Backup Status and Information

Symbol	Allowable assignments	See . . .
PROGRESS	The number of files to be processed before an operator reply is issued by SLS software. If you DO NOT want progress reporting, assign 0. Although this symbol must be defined, its value is not used for Oracle RMU backups.	Enabling Operator Replies for System Backup Progress
REPLY_MSG	The command you want to use to send messages when the system backup operation commences and completes.	Controlling DCL REPLY Messages
STATUS_MAIL	The recipient name of the user to whom you want to mail system backup status.	Section 5.4.7.2
LOG_FILE	The name for the log file created by the system backup operation.	Section 5.4.7.3
LISTING_GEN	Symbols for constructing the name of your listing file. Refer to the symbols of SAVESET_GEN. Although this symbol must be defined, its value is not used for Oracle RMU backups.	Section 5.4.7.4
FULL	Controls the listing file format: <ul style="list-style-type: none"> • Short file format, assign 0. • Long file format, assign 1. Although this symbol must be defined, its value is not used for Oracle RMU backups.	Section 5.4.7.5
PRINT_Q	Any print queue for printing the listing file. Although this symbol must be defined, its value is not used for Oracle RMU backups.	Section 5.4.7.6

B

Remote Backup Worksheet

Use this worksheet to determine the configuration for your system. This worksheet associates a backup operation (or_SBK.COM file) with the corresponding nodes, media types and tape devices. Use the columns as follows:

- Column 1-Backup operation name or *_SBK.COM file
- Columns 2 and 3-Source node names and disk device names
- Columns 4, 5, and 6-Destination node names, media type, and the RDF characteristic name

Table B-1 Planning Remote Backups-Worksheet

Backup/ Name	Source Node		Destination Node		
	Node Name	Disk Device Name	Node Name	Media Type	Type Device Name/RDF Characteristic Name
1 _____	_____	_____	_____	_____	_____
		_____			_____
		_____			_____
		_____			_____
		_____			_____
2 _____	_____	_____	_____	_____	_____
		_____			_____
		_____			_____
		_____			_____
		_____			_____
3 _____	_____	_____	_____	_____	_____
		_____			_____
		_____			_____
		_____			_____

Remote Backup Worksheet

Table B-1 Planning Remote Backups-Worksheet

Backup/ Name	Source Node		Destination Node		Type Device Name/RDF Characteristic Name
	Node Name	Disk Device Name	Node Name	Media Type	
4 _____	_____	_____	_____	_____	_____
		_____			_____
		_____			_____
		_____			_____
		_____			_____
5 _____	_____	_____	_____	_____	_____
		_____			_____
		_____			_____
		_____			_____
		_____			_____
6 _____	_____	_____	_____	_____	_____
		_____			_____
		_____			_____
		_____			_____
		_____			_____

Part II

MDMS Services Guide

This part contains information about MDMS operations.

- How to customize the MDMS software
- How to work with jukebox devices
- How to work with remote devices
- How to manage media and devices through MDMS

Introduction to Media and Device Management Services

This chapter introduces Media and Device Management Services for OpenVMS (MDMS) and suggests ways to make managing your media and devices as efficient as possible. Throughout this document, Media and Device Management Services is referred to as MDMS.

MDMS serves as an information repository for media and device configurations. MDMS reflects the physical and logical design of your storage devices (tape and optical drives) and the volumes on which you store data.

It is important to note that MDMS provides media and device management services. Storage management tasks, such as backup and restore activities, are managed by the layered applications you use with this product.

11.1 What MDMS Provides

MDMS provides the following services:

- Media management-MDMS allows you to:
 - Add and remove volumes
 - Print volume labels
 - Generate volume reports
 - Create volume sets
 - Control access to volumes
 - Add and remove magazines
 - Bind media into a magazine
 - Show the contents of a magazine
- Device management-MDMS allows you to:
 - Logically configure the devices in your system
 - Add and remove devices
 - Select devices for use
 - Load and unload volumes on devices

For a complete list of MDMS-supported devices, see the *SLS Software Product Description*.

- Authorization management-MDMS allows you to determine and control who can access media.
- Automated device management-MDMS allows you to:

Introduction to Media and Device Management Services

11.2 Where MDMS Stores Information

- Control jukeboxes, such as the TL8xx family of tape jukeboxes, Digital Linear Tape (DLT[™]) loaders, and the StorageTek[R] ACS 4400 and StorageTek WolfCreek silos
- Import media, export media, and perform inventories for the jukeboxes
- Remote device management-MDMS enables you to configure the software so you can make remote devices available for MDMS operations. MDMS uses the Remote Device Facility (RDF)[™] software to enable this functionality.

11.2 Where MDMS Stores Information

Because MDMS serves as an information repository for media and device information, you can benefit by understanding how this information is stored. MDMS stores site-specific information in the databases described in Table 11–1.

Table 11–1 MDMS Databases and Their Contents

Database	Contents
Volume	Descriptive information about each volume.
Magazine	Names of magazines; which volumes are logically bound into a magazine; where the magazine is imported.
Slot	Vault slots available to store a volume.
Pool Authorization	Users that are allowed access to specified volume pools.
Vault	A text file containing dates that identify when volumes should be moved onsite or offsite.

11.3 MDMS User Interfaces

You can issue commands to MDMS through the Digital Command Language (DCL[™]) interface or through forms-driven menus. The *Storage Library System for OpenVMS Command Reference Guide* describes STORAGE commands.

11.4 Who Interacts with MDMS

The storage administrator's responsibilities may include:

- Installing MDMS software based on issues such as:
 - Where the devices are located that read and write the stored data
 - Where the MDMS databases are located
- Configuring the MDMS software to make the best use of available computing, storage, and personnel resources based on such issues as:
 - The appropriate level of media and device management services you need to provide
 - The safety of the MDMS databases
 - The control of devices and resources
- Defining, implementing, and administering your media and device management policy

ment Services

The operator's responsibilities may include:

- Providing physical media for use
- Placing media into devices
- Removing media from devices

Configuring for Media Management

This chapter explains how to customize the file `SYSS$MANAGER:TAPESTART.COM` so that MDMS works with the media and devices on your system. This chapter contains information about:

- The values of `TAPESTART.COM` symbols and definitions
- Running the MDMS autoconfiguration utility to define default media triplets in `TAPESTART.COM`

12.1 Understanding `TAPESTART.COM` Symbols and Definitions

MDMS requires various symbols to be defined in a file called `SYSS$MANAGER:TAPESTART.COM`. This section describes the symbols that you need to modify for your environment. After modifying `TAPESTART.COM`, you must restart MDMS to invoke the changes. See *Media and Device Management Services for OpenVMS Installation Guide* for instructions about starting the MDMS software.

The `TAPESTART.COM` symbols explained in this section are separated into the following categories:

- Basic MDMS symbols
- Media triplets
- Volume control
- Operator terminal control
- Drive control
- Tape jukebox definitions
- Remote device support

12.1.1 Basic MDMS Symbols

The file `TAPESTART.COM` contains a series of symbols that define the basic configuration of your MDMS software. These include:

- `PRI`—Identifies the primary node or OpenVMS Cluster alias name for the MDMS server. The MDMS installation procedure defines this value on the MDMS client node when you install MDMS client software.
- `DB_NODES`—Identifies the nodes on which the MDMS server software is installed. Any of these nodes can start the MDMS database process. However, this is only true if `PRI` is configured in the following manner:

Configuring for Media Management

12.1 Understanding TAPESTART.COM Symbols and Definitions

IF PRI . . .	THEN . . .
Consists of a single node name	Any nodes assigned to the symbol DB_NODES are ignored.
Consists of a OpenVMS Cluster alias name	Any of the nodes assigned to the symbol DB_NODES are allowed to be the server node.

- PRIMAST—Identifies the device and directory where the volume database is located.
- MGRPRI—Defines the base priority for MDMS processes; if this value is too low on a heavily loaded system, process connections could time out.
- NET_REQUEST_TIMEOUT—Identifies the amount of time (in seconds) that the MDMS server waits for a response from an MDMS client.
- VERBOSE—Enables operator messages when the processes connect or disconnect.
- BATN—Defines the MDMS queues.

Example 12–1 shows some sample definitions for these symbols.

Example 12–1 Basic TAPESTART.COM Symbols

```

$ PRI := WAGON

$ DB_NODES := WHEEL1, WHEEL2

$! -----

$!

$! MDMS Base Configuration Symbols

$!

$! -----

$! Device and directory for SLS databases

$!

$ PRIMAST := SLS$ROOT:[PRIMAST]

$!

$! -----

$! Timeout interval (in seconds) for client-server connection response

$!

$ NET_REQUEST_TIMEOUT = 120

$!

$! -----

$! Batch queue for SLS processing

```

Configuring for Media Management

12.1 Understanding TAPESTART.COM Symbols and Definitions

```
$!  
  
$ IF NODE .NES. " " .AND. F$GETSYI("CLUSTER_MEMBER","'NODE'") .EQ. "TRUE"  
  
$ THEN BATN := SLS$'NODE' -  
  
/ON='NODE': -  
  
/JOB_LIM=1 -  
  
/BASE=4 -  
  
/PROT=(S:RWED,O:RWED,G,W)  
  
$ ELSE BATN := SLS$ -  
  
/JOB_LIM=1 -  
  
/BASE=4 -  
  
/PROT=(S:RWED,O:RWED,G,W)  
  
$ ENDIF  
  
$!  
  
$! -----  
  
$! Execution priority for SLS server and client processes  
  
$!  
  
$ MGRPRI := 8  
  
$!  
  
$! -----  
  
$! Enable or Disable broadcast of network state changes to operators  
  
$!  
  
$ VERBOSE = 0  
  
$!  
  
$! -----
```

12.1.2 Media Triplets

MDMS uses a concept called a **media triplet** to identify a media type and its associated drives. A media triplet defines the media and drives that the MDMS software is allowed to use. You can define up to 32 media triplets for your MDMS environment. Each media triplet identifies:

- **MTYPE_n**—A unique media type name, often related to the physical media type, such as TK50, TA90, or TK87K.
- **DENS_n**—The density for the media type; if the drives in this media triplet support tape data compaction, set DENS_n to COMP; if the drives handle 9-track tapes, you can set the value to 6250, 1600, or 800; otherwise, you may leave it blank.
- **DRIVES_n**—The drives that can support the media type.

Configuring for Media Management

12.1 Understanding TAPESTART.COM Symbols and Definitions

In addition, you can define a fourth item, `CAPACITY_n`, that identifies the amount of storage space available in megabytes on one piece of this type of media. The `CAPACITY_n` symbol is not required for basic MDMS functionality, but it may be needed for a particular MDMS client, such as POLYCENTER Sequential Media Filesystem for OpenVMS (SMF).

12.1.2.1 Guidelines for Media Triplet Assignments

The following restrictions apply to magnetic tape and optical disk media types assigned to a media triplet:

- Three attributes (`MTYPE_n`, `DENS_n`, `DRIVES_n`) must be used together to create a media triplet.
- The sequence indicated by *n* must start at 1 and be sequential and contiguous. You cannot leave an `MTYPE_n` assignment blank, except for the last media triplet defined in the file `TAPESTART.COM`.
- A maximum of 32 sets of media triplets (values of *n*) is allowed.
- The assignments to these symbols must be meaningful to define your site's media and devices.
- Density values for TK50 and RV02K media types must be left blank. You can assign the `DENS_n` symbol either a blank or a single value accepted by the following:
 - `/DENSITY` qualifier of the `INITIALIZE DEVICE` command
 - `/DENSITY` qualifier of the `MOUNT` command
 - `/DENSITY` qualifier of the `BACKUP` command
 - `/MEDIA_FORMAT` qualifier of the `BACKUP` command for systems running OpenVMS-Version 6.2 or higher
- The `DRIVES_n` symbol must be assigned specific device names. You can use a comma-separated list to assign `DRIVES_n` the name of one or more devices known to your system.

12.1.2.2 Default Media Triplet

The file `TAPESTART.COM` provides one default media triplet. The first media type, density, and drive assignment is a default assignment supplied by MDMS during the installation procedure. The following example shows the default media triplet created for a 9TRACK media type and supporting drive:

Default media triplet:

```
$ MTYPE_1 := 9TRACK

$ DENS_1 := 6250

$ DRIVES_1 := NODE01$MF,NODE01$MU
```

Note

The IVP requires that at least one media triplet be defined. Do not try to run the IVP without a media triplet define in the file `TAPESTART.COM`.

Configuring for Media Management

12.1 Understanding TAPESTART.COM Symbols and Definitions

Examples of Media Triplets in TAPESTART.COM

9TRACK Example 1:

In the file TAPESTART.COM on this node, the default media type is 9TRACK. The default density for 9-track tape is 6250 bits per inch (bpi). The 9-track drives on this system that handle 6250 bpi tape are MFA2: and MUA3:.

```
$ MTYPE_1 := 9TRACK
$ DENS_1 := 6250
$ DRIVES_1 := NODE01$MFA2:,NODE01$MUA3:
```

9TRACK Example 2:

This media triplet assignment is for 9-track drives that support an 800 bpi density. There are three drives: MSA1:, MSA2:, and MTA1:.

```
$ MTYPE_2 := 9TRACK_800
$ DENS_2 := 800
$ DRIVES_2 := NODE01$MSA1:,NODE01$MSA2:,NODE01$MTA1:
```

TK50 Example:

This media triplet assignment is for a TK50 named MUA1:. Because there is no density associated with the TK50 media, the density symbol is left blank.

```
$ MTYPE_3 := TK50
$ DENS_3 :=
$ DRIVES_3 := NODE01$MUA1:
```

RV02K Example:

This media triplet assignment is for an RV02 named MUA2:. Because there is no density associated with the RV02K media, the density symbol is left blank.

```
$ MTYPE_4 := RV02K
$ DENS_4 :=
$ DRIVES_4 := NODE01$MUA2:
```

TA90K Example:

This media triplet assignment is for a TA90E controller named MUA3:, with data compaction enabled.

```
$ MTYPE_5 := TA90E
$ DENS_5 := COMP
$ DRIVES_5 := NODE01$MUA3:
```

12.1.2.3 Creating Default Media Triplets

MDMS provides an autoconfiguration utility that creates default media triplets. For each tape device on the system from which you run the autoconfiguration utility, the utility creates a media triplet. Note that these are defaults, and you can choose to change the suggested triplets.

Configuring for Media Management

12.1 Understanding TAPESTART.COM Symbols and Definitions

Refer to Table 12–1 for instructions about creating default media triplets.

Table 12–1 Creating Default Media Triplets

IF . . .	THEN . . .
You are installing MDMS for the first time and you do not have a pre-existing TAPESTART.COM file	<p>The installation procedure automatically creates the file SYSS\$MANAGER:TAPESTART.COM and runs the autoconfiguration utility and creates your default media triplets.</p> <p>Insert the media triplets into TAPESTART.COM as shown in Table 12–2.</p>
You are upgrading MDMS and you have an existing TAPESTART.COM file	<p>Use the autoconfiguration utility to create media triplets for any new devices on your system.</p> <p>To create new media triplets, enter the following command at the DCL system prompt:</p> <pre>\$ RUN SLSS\$SYS- TEM:SLSS\$AUTOCONFIGURE_MEDIA_TRIPLE TS</pre> <p><u>Result:</u> MDMS creates a file located in SLSS\$DATAAC and named SLSS\$AUTOCONFIGURE_MEDIA_TRIPLETS.TXT ¹.</p> <p>Insert the media triplets into TAPESTART.COM as shown in Table 12–2.</p>

¹ If MDMS is not running, the logical name SLSS\$DATAAC is not defined. This causes an error if you try to run the autoconfiguration utility. Define SLSS\$DATAAC to be any location and run the autoconfiguration utility again.

12.1.2.4 Inserting Media Triplets Into TAPESTART.COM

To insert default media triplets into the file TAPESTART.COM, use the procedure in Table 12–2.

Table 12–2 Inserting Media Triplets into TAPESTART.COM

Step	Action
1.	Edit the file TAPESTART.COM and find the default media triplet provided by MDMS. Comment out this media triplet and include the file SLSS\$DATAAC:SLSS\$AUTOCONFIGURE_MEDIA_TRIPLETS.TXT. The media triplets created by the autoconfiguration utility are located in this file.
2.	Once the media triplets are included in TAPESTART.COM, you may need to delete existing media triplets from TAPESTART.COM and renumber the new media triplets so they are in sequential numerical order.
3.	You may also need to modify the media triplets created by the autoconfiguration utility, or add CAPACITY_n symbols as needed.

Note

OpenVMS does not correctly recognize all devices. For some devices, the autoconfiguration utility sees the device but may not create an accurate triplet definition. If the device is not recognized, the autoconfiguration utility gives the device the name MTYP_xxxx, where xxxx is the device type.

12.1.2.5 Media Triplets for Tape Jukebox Devices

The autoconfiguration utility does not create media triplets for tape jukebox devices. For information on creating media triplets for tape jukebox devices, see Chapter 13

12.1.3 Volume Management Symbols

There are several symbols MDMS requires to control volume behavior:

- LOC—The default physical location of the media library.
- ALLOCSIZE—The default reel size used for the STORAGE ALLOCATE command.
- LBL—The default file name or device name to which volume labels are written.
- FRESTA—The state into which deallocated volumes are put.
- TRANS_AGE—The length of time a volume stays in the transition state.
- ALLOCSCRATCH—The default scratch date set for the STORAGE ALLOCATE command.
- MAXSCRATCH—The maximum scratch time for an unprivileged user.
- TAPEPURGE_WORK—The symbol definition that determines whether to send mail when volumes reach the scratch date.
- TAPEPURGE_MAIL—The symbols definition that allows identifying additional users, besides MDMS, to whom to send mail messages when volumes reach the scratch date.
- VLT—The symbol used to assign a name for the default offsite vault, if you intend to move media to an offsite location.
- TOPERS—The symbol used to identify the OPCOM class to use to send load requests.

Example 12–2 shows default definitions for the volume management symbols.

Example 12–2 Example Volume Management Symbols

```
$! -----  
  
$!  
  
$! SLS Volume Control Symbols  
  
$!  
  
$! -----  
  
$! Name of media library location  
  
$!  
  
$ LOC := HEADQUARTERS  
  
$!
```

Configuring for Media Management

12.1 Understanding TAPESTART.COM Symbols and Definitions

```
$! -----  
  
$! Default protection of volumes  
  
$!  
  
$ PROTECTION = %X0133  
  
$!  
  
$! -----  
  
$! Default reel size for STORAGE ALLOCATE command  
  
$!  
  
$ ALLOCSIZE = 2400  
  
$!  
  
$! -----  
  
$! Name of file or device to which volume labels are written  
  
$!  
  
$ LBL := _NL:  
  
$!  
  
$! -----  
  
$! State to put deallocated volumes into  
  
$!  
  
$ FRESTA := TRAN  
  
$!  
  
$! -----  
  
$! Time that a volume stays in transition state  
  
$!  
  
$ TRANS_AGE := 14 0:0:0  
  
$!  
  
$! -----  
  
$! Default time that the scratch date is set with a STORAGE ALLOCATE  
  
$!  
  
$ ALLOCSCRATCH := 365 0:0:0  
  
$!  
  
$! -----
```

Configuring for Media Management

12.1 Understanding TAPESTART.COM Symbols and Definitions

```
$! Maximum scratch time (for a non-OPER privileged user)

$!

$ MAXSCRATCH :=

$!

$! -----

$! Notify by mail when volumes have reached the scratch date

$!

$ TAPEPURGE_WORK := MAIL

$!

$! -----

$! If notifying by mail, assign additional recipients of message

$!

$ TAPEPURGE_MAIL := SYSTEM

$!

$! -----

$! Default name for the offsite vault

$!

$ VLT := DPS

$!

$! -----

$! Operator(s) to receive volume load requests.

$!

$ TOPERS := TAPES

$!
```

12.1.3.1 Volume Management Privileges Symbols

MDMS volume management privileges enable users to perform volume management functions using MDMS. These privileges are defined to correspond to OpenVMS privileges. Volume management privileges include the following:

- PRIV_SEEANY—The user (typically the operator) can inquire about any volume.
- PRIV_MODANY—The user can modify any volume's attributes.
- PRIV_MAXSCR—The user can override the MAXSCRATCH symbol.
- PRIV_LABEL—The user can create new label files through the STORAGE CREATE LABEL command.

Configuring for Media Management

12.1 Understanding TAPESTART.COM Symbols and Definitions

- PRIV_CLEAN—The user can use the STORAGE RELEASE command.
- PRIV_MODDOWN—The user can modify volumes the user owns through the STORAGE SET VOLUME command.

Example 12–3 shows how these privileges are typically defined.

Example 12–3 Volume Management Privileges Symbols

```
$! -----  
  
$! SLS software execution privileges  
  
$!  
  
$ PRIV_SEEANY := OPER  
  
$ PRIV_MODANY := OPER  
  
$ PRIV_MAXSCR := OPER  
  
$ PRIV_LABEL := OPER  
  
$ PRIV_CLEAN := OPER  
  
$ PRIV_MODDOWN := TMPMBX  
  
$!
```

12.1.3.2 Volume Loading Symbol

The QUICKLOAD symbol controls how MDMS performs volume loading. If you set the QUICKLOAD symbol to 1, this indicates the operator does not need to respond to OPCOM messages after a volume is loaded.

Example 12–4 shows how the QUICKLOAD symbol is typically defined.

Example 12–4 Volume Loading Symbol

```
$! -----  
  
$! STORAGE LOAD automatic load flag  
  
$!  
  
$ QUICKLOAD = 0
```

12.1.4 Operator Terminal Control Symbols

You can define operator terminal control sequences to use for OPCOM messages in MDMS. The default definitions are set to work for VT100-, VT200-, and VT300-series terminals.

Example 12–5 shows the default definitions typically used for operator terminal control symbols.

Example 12–5 Operator Terminal Control Symbols

```
$! -----  
  
$!  
  
$! Operator Terminal Control
```

Configuring for Media Management 12.1 Understanding TAPESTART.COM Symbols and Definitions

```
$!  
  
$! -----  
  
$! Basic control assignments  
  
$!  
  
$ CRLF[0,8] = 13  
  
$ CRLF[8,8] = 10  
  
$ ESC[0,8] = 27  
  
$!  
  
$! -----  
  
$! Load requests  
  
$!  
  
$ ESC_LOAD_BOLD = ESC + "[1m" + ESC + "[7w"  
  
$ ESC_LOAD_BLNK = ESC + "[5m" + ESC + "[7w"  
  
$ ESC_LOAD_NORM = ESC + "[m" + ESC + "[w"  
  
$!  
  
$! -----  
  
$! Drive allocation  
  
$!  
  
$ ESC_ALLOC_BOLD = ESC + "[1m"  
  
$ ESC_ALLOC_NORM = ESC + "[m"  
  
$!  
  
$! -----  
  
$! Volume mount label and ring verification  
  
$!  
  
$ ESC_MOUNT_OPER = CRLF + ESC + "[1m" + ESC + "#6 OPERATOR:"  
  
$ ESC_MOUNT_BOLD = ESC + "[1m"  
  
$ ESC_MOUNT_NORM = ESC + "[m"  
  
$!  
  
$! -----
```

Configuring for Media Management

12.1 Understanding TAPESTART.COM Symbols and Definitions

12.1.5 Drive Control Symbols

The following symbols control how MDMS deals with specific drives:

- ALLDEV—Identifies the drives to be dedicated solely to MDMS. If the ALLDEV symbol is not empty, MDMS *only* uses the drives listed in ALLDEV. The drives listed in the ALLDEV symbols are allocated by MDMS when SLS\$STARTUP.COM is executed.
- SELDEV—Identifies the drives that can be automatically selected by MDMS without operator intervention.

Requirement:

Any drive specified in the SELDEV symbol also must be specified in the ALLDEV symbol.

- ALLTIM—Specifies the default interval to wait when checking to see whether a drive is available for MDMS use.

Example 12–6 shows the typical assignments for the drive control symbols.

Example 12–6 Drive Control Symbols

```
$! -----  
  
$! Drives to be controlled by MDMS  
  
$!  
  
$ ALLDEV := MUA0:, $3$MUA1:  
  
$ SELDEV := $3$MUA1:  
  
$!  
  
$! -----  
  
$! Time interval to check for freed drives  
  
$!  
  
$ ALLTIM := 0 0:0:30  
  
$!
```

12.1.6 Miscellaneous Symbol Assignments

There are several other symbol assignments in the file TAPESTART.COM that the MDMS software requires to run.

Note

If you are not an SLS user, do not delete or redefine these symbols or you could experience unpredictable results. If you are an SLS user, see the SLS documentation for information about modifying these symbols.

Configuring for Media Management 12.1 Understanding TAPESTART.COM Symbols and Definitions

Example 12–7 shows the default assignments for these symbols.

Example 12–7 Miscellaneous Default Symbol Assignments

```
$! Default time that the scratch date is set with a STORAGE SAVE command
$!
$ BACKUPSCRATCH := 365 0:0:0
$!
$! -----
$! Cleanup queue and run time
$!
$ CLEANUP_Q := 'F$EXTRACT(0,F$LOCATE("/ ",BATN),BATN)'/AFTER=03:00
$!
$! -----
$!
$! Controlling Standby archiving
$!
$! -----
$! Log file for standby archiving
$!
$ SBARLOG := SLS$DATA:STANDBY_ARCHIVE.LOG;
$!
$! -----
$! Request scan interval time
$!
$ SBARINT := 00:00:30
$!
$! -----
$! Default archive class for backup screen
$!
$ SBACLAS = "FOREVER <- insert archive class here"
$!
$! -----
```

Configuring for Media Management

12.1 Understanding TAPESTART.COM Symbols and Definitions

```
$! UNATTENDED BACKUPS flag
```

```
$!
```

```
$ UNATTENDED_BACKUPS = 0
```

```
$!
```

Managing Jukebox Devices Using MDMS

MDMS provides support for the following devices as robotically controlled jukeboxes:

- Magnetic tape jukeboxes - Digital Automatic Tape (DAT) magazine loaders, Digital Linear Tape (DLT) magazine loaders, and the TL820 and TL810 devices. For a complete list of supported tape jukeboxes, see the SLS SPD.
- Digital Cartridge Server Component (DCSC)-controlled robotic silos StorageTek Automated Cartridge System (ACS) 4400 silo and StorageTek WolfCreek silo.

Note

DCSC is not supported on systems running OpenVMS Version 7.1.

MDMS enables you to perform the following tasks for these devices:

- Physically adding media (STORAGE IMPORT)
- Physically removing media (STORAGE EXPORT)
- Physically loading media (STORAGE LOAD)
- Physically unloading media (STORAGE UNLOAD)
- Identifying what media is in the jukebox (INVENTORY)
- Finding out what jukeboxes exist and what they contain (SHOW)

For each type of jukebox, MDMS provides unique, specific commands to perform these functions.

13.1 Working with Magnetic Tape Jukeboxes

MDMS provides support for the following varieties of magnetic tape jukeboxes:

- DLT magazine loaders that only accept tape volumes from a physical container that holds multiple tape volumes, called a **magazine**. These include Tx8n7 and TZ8n5 loaders.
- TLZ6L, TLZ7L, and 4mm DAT magazine loaders.
- Digital TL810 and TL820 devices that accept tape volumes from a magazine or individually through an **in port**.

For these groups of magnetic tape jukeboxes, MDMS provides the following commands:

- IMPORT MAGAZINE—Requires an operator to physically place a magazine in the jukebox and updates the magazine and volume databases to indicate the jukebox location of the volumes (except for the TL810).

Managing Jukebox Devices Using MDMS

13.1 Working with Magnetic Tape Jukeboxes

- EXPORT MAGAZINE—Requires an operator to physically remove a magazine from the jukebox and updates the magazine and volume databases to indicate the jukebox location of the volumes (except for the TL810).
- INVENTORY JUKEBOX—Determines what cartridges are contained in the jukebox and optionally adds their associated volumes to the magazine and volume databases.

In addition, for the TL810 and TL820 devices, MDMS provides the following additional commands:

- IMPORT CARTRIDGE—Physically moves a volume into the jukebox through the **in port**.
- EXPORT CARTRIDGE—Physically moves a volume out of the jukebox through the **out port**.

All magnetic tape jukeboxes use the same approach to configuration and interact with the MDMS magazine or volume databases.

13.1.1 Customizing TAPESTART.COM for Robotically Controlled Magnetic Tape Jukebox Devices

To use magnetic tape jukebox devices as robotically controlled devices, you must perform the following steps:

1. Determine the hardware configuration for your magnetic tape jukebox as described in Section 13.1.2.
2. Assign all of the tape jukeboxes to the TAPE_JUKEBOXES symbol in the file SYSS\$MANAGER:TAPESTART.COM. The name that you create for each tape jukebox should be meaningful to you. When cartridges are imported into a tape jukebox, the tape jukebox name in which the cartridge resides is displayed in the Jukebox field in the volume's database record.

To define the symbol TAPE_JUKEBOXES in the file TAPESTART.COM, review Section 13.1.1.1 and Section 13.1.1.2 and then see Table 13–1 to identify the type of hardware device that you want MDMS to recognize. Table 13–1 references the correct section determined by the hardware configuration.

13.1.1.1 Required Naming Conventions

When defining tape jukebox names, the following requirements are imposed by MDMS:

- A *tape jukebox name* can contain any alphanumeric string.
- A *tape jukebox name* cannot exceed 31 characters.
- The *tape jukebox name* (or a comma-separated list of tape jukebox names) assigned to the TAPE_JUKEBOXES symbol must be enclosed within quotation marks.
- The *tape drive name* must include the allocation class (NODE\$ prefix string).
- The *tape drive name* must include the NODE:: node name prefix even if the drive is local
- All *tape drive names* must have a trailing colon, for example:

```
NODE01$MUA1:
```

- You must include all tape drive names, even if you do not intend for MDMS to use them. MDMS selects only the tape drives defined in a media triplet.
- Define the symbols exactly the same way on MDMS client nodes as on the MDMS server nodes.

Managing Jukebox Devices Using MDMS

13.1 Working with Magnetic Tape Jukeboxes

13.1.1.2 Required Media Triplets

For each drive you want MDMS to use, the drive must also be assigned to the DRIVES_n symbols in a media triplet to associate it with a media type. These drive names must contain an allocation class or NODE\$ prefix string. MDMS selects only those drives defined in a media triplet. 12.1.2 describes how to define media triplets.

Requirement:

If the tape device is remote, you must also include the NODE:: node name prefix in the tape device name.

Example:

```
MTYPE_1 := TA90E  
  
DENS_1 :=  
  
DRIVES_1 := NODE01::NODE01$MUA0:
```

13.1.2 Determining Your Hardware Configuration

Figure 13–1 illustrates the possible types of hardware configurations for magnetic tape jukeboxes.

Figure 13–1 Determining a Magnetic Tape Jukebox Hardware Configuration

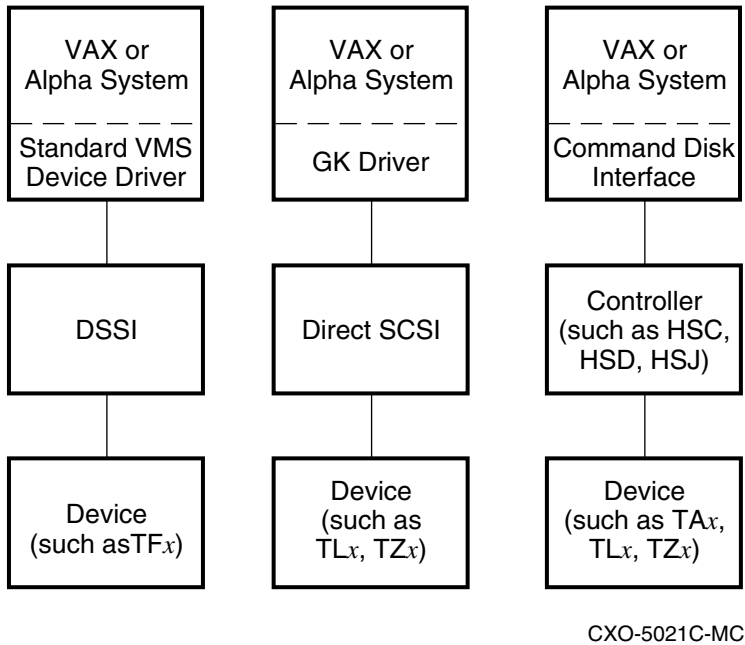

Managing Jukebox Devices Using MDMS

13.1 Working with Magnetic Tape Jukeboxes

The important information to know when using Figure 13–1 is determining whether your hardware configuration is:

- A direct-connect DSSI device and uses a standard OpenVMS installed device driver.
- A directly-connect SCSI device and uses the GK Driver software (standard with OpenVMS)
- A device connected through a controller (such as an HSC, HSD, or HSJ) and uses the command disk interface

Typically, a hardware configuration contains a combination of device types. To determine how to define the symbol TAPE_JUKEBOXES and its associated symbols in the file TAPE-START.COM, refer to Table 13–1. This table identifies the type of device, the type of connection, and provides a reference to the appropriate section.

Table 13–1 Determining Your Hardware Configuration

Type of Tape Jukebox	Type of Connection	See
TF nnn	Direct connect DSSI	Section 13.1.3
TL nnn , TZ nnn	Direct connect SCSI	Section 13.1.4
TA nnn , TL nnn , TZ nnn	Controller	Section 13.1.5

13.1.3 Direct Connect DSSI Devices

A direct-connect DSSI device is a device that is connected directly to the VAX or Alpha system, such as a TF867. It uses a standard OpenVMS installed device driver and does not require you to install a separate device driver for this type of hardware configuration.

Note

For DSSI devices, the robot commands are sent directly to the device; therefore, the robot device name and the tape drive name are exactly the same.

13.1.3.1 Customizing TAPESTART.COM for Direct DSSI Devices

To define the TAPESTART.COM symbols for a direct-connect DSSI device, assume that JUKEBOX1 is a TF867 whose physical device name is MIA5:, and is connected to node NODE01::.

Example 13–1 shows the TAPESTART.COM symbol definitions for JUKEBOX1.

Example 13–1 Tape Jukebox Symbols for a Direct Connect DSSI Device

```
$ TAPE_JUKEBOXES := "JUKEBOX1"1

$ JUKEBOX1 := "NODE01:::$1$MIA5:"2 ,NODE01:::$1$MIA5:"3 "
```

Where:

- ¹ JUKEBOX1 is the name of the tape jukebox.
- ² NODE01:::\$1\$MIA5: is the NODE::: node name and name of the robot device (including the allocation class).
- ³ NODE01:::\$1\$MIA5: is the NODE::: node name and name of the tape drive controlled by the robot device. The tape drive name must be prefixed by an allocation class or a NODE\$ prefix string.

13.1.4 Direct Connect SCSI Devices

A direct-connect SCSI device is a SCSI device that is connected directly to the VAX or Alpha system and uses the GK Driver software. GK Driver is a standard OpenVMS device driver and does not require a separate installation.

However, you must first create a tape robot unit to use the robotic features on tape jukeboxes directly connected through a SCSI bus.

Note

For direct-connect SCSI devices (with the exception of a TL810 or TL820), the robot device name is the name of the tape drive incremented by one (1). For a TL810 or TL820 device, the robot device name is the assigned SCSI ID.

13.1.4.1 Creating a Tape Robot Unit

MDMS directs the robotic control commands to a tape robot unit which then passes the commands to the actual hardware robot device.

To create a tape robot unit, follow the procedure in Table 13–2.

Table 13–2 Creating A Tape Robot Unit

Step	Action
1.	<p>1 For SCSI magazine loaders connected directly to a SCSI bus, enter the SYSGEN or SYSMAN command in the following format:</p> <p><u>VAX system:</u></p> <pre style="margin-left: 40px;">\$ MCR SYSGEN CONNECT GKxxx:/NOADAPTER/DRIVER=GKDRIVER</pre> <p><u>Alpha system:</u></p> <pre style="margin-left: 40px;">\$ MCR SYSMAN IO CONNECT GKxxx:/NOADAPTER/DRIVER=SYS\$GKDRIVER</pre> <p><u>Where:</u> GKxxx: is the robot device name. The robot device name is always the same as the tape drive name incremented by one, and without any prefixes (allocation class or NODE\$ prefix) to the GK string. For example, a tape drive name of \$1\$MKA200: could use a robot device name of GKA201:.</p> <p><u>Note:</u> A tape drive is configured automatically.</p>
2.	<p>HP recommends that you include the SYSGEN commands in your system startup command procedure. The following example shows how to display a tape jukebox from the VMS system prompt:</p> <pre style="margin-left: 40px;">\$ SHOW DEVICE/FULL \$3\$MKA400:</pre> <p>The following example shows how to make the tape jukebox known to MDMS:</p> <pre style="margin-left: 40px;">\$ MCR SYSGEN SYSGEN> CONNECT GKA401/DRIVER=GKDRIVER/NOADAPTER SYSGEN> EXIT \$ SHOW DEVICE/FULL GKA401</pre> <p style="margin-left: 40px;">Device GKA401: is online, shareable.</p>

Managing Jukebox Devices Using MDMS

13.1 Working with Magnetic Tape Jukeboxes

Table 13–2 Creating A Tape Robot Unit

Step	Action			
	Error count	0	Operations completed	4071
	Owner process	" "	Owner UIC	[0,0]
	Owner process ID	00000000	Dev Prot	S:RWLP,O:RWLP,G:RWL P,W:RWLP
	Reference count	0	Default buffer size	0

Result:

This example enables robotic control for a TZ867 tape drive with device name \$3\$MKA400 and a robot tape unit with the device name GKA401. Note that there is no tape allocation class prefix on the device name of the robot tape unit.

13.1.4.2 Customizing TAPESTART.COM Symbols for a Direct Connect SCSI Device

In the case of tape jukeboxes connected to a local SCSI bus (connected directly to the VAX or Alpha system instead of through a controller, such as an HSC, HSD, or HSJ), a separately addressable device is used as the robot device. Assume that JUKEBOX2 is a TZ877 device, whose tape drive name is \$3\$MKA300:. The name of the robot that controls this device would be GKA301:. The robot device name is incremented by one from the drive name.

Example 13–2 shows how the definition for JUKEBOX2 on node NODE02:: would then be required.

Example 13–2 Tape Jukebox Symbols for a Direct Connect SCSI Device

```
$ TAPE_JUKEBOXES := "JUKEBOX2"1

$ JUKEBOX2 := "NODE02::GKA301:"2 ,NODE02::$3$MKA300:"3 "
```

Where:

- 1** JUKEBOX2 is the name of the tape jukebox.
- 2** NODE02::GKA301: is the NODE:: node name and name of the robot device.
- 3** NODE02::\$3\$MKA300: is the NODE:: node name and drive name controlled by the robot device (NODE02::GKA301:). The tape drive must be prefixed by a NODE\$ node name or an allocation class.

13.1.5 Controller-Connected SCSI Devices

If your device is connected to a VAX or Alpha system through an HSC controller, you must have a K.SCSI channel card.

The following sections describe how to configure tape jukeboxes connected through an HSC, HSD, or HSJ controller.

Managing Jukebox Devices Using MDMS

13.1 Working with Magnetic Tape Jukeboxes

13.1.5.1 Using SCSI Tape Jukeboxes Connected to an HSC Controller

For devices connected in a OpenVMS Cluster environment through an HSC controller, use a K.SCSI channel card.

Table 13–3 Using a SCSI Loader on an HSC Controller

Step	Action
1.	Determine the REQUESTER ID for the K.SCSI that the media robot is connected to.
2.	Determine the SCSI ID for the media robot.
3.	From the HSC console, enter the following command; RUN KSUTIL
4.	Respond to the REQUESTER ID query with the information obtained in Step 1.
5.	Select the Media Loader and Command Disk Configuration screen on main menu.
6.	Enable the command disk engine (option E)
7.	Configure the command disk (option C)
8.	MSCP UNIT: <i>number</i> . The MSCP unit number is an arbitrary number identifying the command disk. The configuration utility will prefix a 6 to the digits entered creating a number such as a DUA6xxx device (visible from VMS).
9.	Set the HSC-A Switch to ON by entering a T
10.	Enter the SCSI ID for the tape jukebox.
11.	Enter the LUN (1) for the media robot (not used for TL820 and TL810).
12.	Enter X exit to main screen
13.	To exit the KSUTIL utility, press Ctrl G
14.	Enter Ctrl C to show the command disk interface (CDI)

13.1.5.2 Using A SCSI Tape Jukeboxes Connected to an HSD or HSJ Controller

The procedure in Table 13–4 shows how to use a SCSI device on an HSD or HSJ controller. The procedure in Table 13–5 shows how to use a TL820 SCSI device on an HSD or HSJ controller.

Table 13–4 Using a SCSI Loader on an HSD or HSJ Controller

Step	Action
1.	From the HSx console prompt, add the device using the ADD LOADER command: ADD LOADER LDR421 4 2 1 <u>Note:</u> Typically, the loader name represents the HSC or HSJ port to which it is connected. For example, in the previous example, Port 4, ID 2, LUN 1 = LDR421. For TL820 or TL810 devices, the tape loader is a separate device and has no LUN. For example, Port 3, ID 5, LUN 0 = LDR350

Managing Jukebox Devices Using MDMS

13.1 Working with Magnetic Tape Jukeboxes

Table 13–4 Using a SCSI Loader on an HSD or HSJ Controller

Step	Action
2.	Add a passthrough and reference it to the loader: <pre>ADD PASS PASS1 LDR421</pre> <p><u>Note:</u> The passthrough name is arbitrary.</p>
3.	From the HSx console prompt, add the tape data path using the ADD TAPE command: <pre>ADD TAPE420 4 2 0</pre>
4.	From the HSx console prompt: Enable the device to appear on hosts: <pre>ADD UNIT T420 TAPE420</pre>
5.	Add a command disk unit and reference the passthrough to the command disk unit: <pre>ADD UNIT D623 PASS1</pre> <p><u>Note:</u> The unit name is arbitrary; however it is reflected in the VMS device name displayed from a SHOW DEVICE command.</p>

Table 13–5 Using a TL810/820 SCSI Device Connected to an HSD or HSJ

Step	Action
1.	From the HSx console prompt, set up the drives. The following example assumes the drives and load SCSI paths are all connected to Port 5 on the HSD or HSJ, and the drives are located at SCSI ID numbers 1, 2, and 3. <pre>ADD TAPE TL820_1 5 1 0</pre> <pre>ADD TAPE TL820_2 5 2 0</pre> <pre>ADD TAPE TL820_3 5 3 0</pre>
2.	From the HSx console prompt, configure the drives to show up as MUA501, MUA502, MUA503: <pre>ADD UNIT T501 TL820_1</pre> <pre>ADD UNIT T502 TL820_2</pre> <pre>ADD UNIT T503 TL820_3</pre>
3.	From the HSx console prompt, set up the loader using the ADD LOADER command: <pre>ADD LOADER TL820 5 6 0</pre> <pre>ADD PASS PTL820 TL820</pre> <pre>ADD UNIT D500 PTL820</pre>

The same procedure is used for TL810 devices, except there may be four drives instead of three.

Managing Jukebox Devices Using MDMS

13.1 Working with Magnetic Tape Jukeboxes

13.1.5.3 Customizing TAPESTART.COM Symbols for a Controller-Connected SCSI Device

In the case of tape jukeboxes connected through a controller (such as an HSC, HSD, or HSJ) to a SCSI device, the robot device name is the physical device name. Assume that JUKEBOX3 is a TZ877 device, is available to node NODE03::, and \$1\$DUA877 is the name of the robot device.

Example 13–3 shows how the definition for JUKEBOX3 would then be required.

Example 13–3 Tape Jukebox Symbols for a Controller Connected SCSI Device

```
$ TAPE_JUKEBOXES := "JUKEBOX3"1

$ JUKEBOX3 := "NODE03::$1$DUA877:2 ,NODE03::$1$MUA25:3 "
```

Where:

1 JUKEBOX3 is the name of the tape jukebox.

2 NODE03::\$1\$DUA877 is the NODE:: node name and robot device name.

3 NODE03::\$1\$MUA25 is the NODE:: node name and tape drive name. The tape drive name must be prefixed with an allocation class or a NODE\$ prefix.

For nodes in a OpenVMS Cluster system, set up the TAPESTART.COM on each node as shown in Example 13–4.

Example 13–4 Controller Connected SCSI Device in a OpenVMS Cluster

```
TAPSTART.COM on node NODE03:: is defined as follows:

$ TAPE_JUKEBOXES := "JUKEBOX3"1

$ JUKEBOX3 := "NODE03::$1$DUA877:2 ,NODE03::$1$MUA25:3 "

TAPSTART.COM on node DAY:: is defined as follows:

$ TAPE_JUKBOXES := "JUKEBOX3"

$ JUKEBOX3 := "DAY::$1$DUA877, DAY::$1$MUA25:"
```

RDF Restriction:

If a RDF client node needs access to a robotic device in a OpenVMS Cluster system, do not assign the cluster alias name. Instead, assign the node name of the server node serving the robotic device.

13.1.5.4 TL810- and TL820-Type Devices with Multiple Drives

The TL810- and TL820-type devices contain more than one drive. You can allow MDMS to use one or more of them. The physical device numbers used for a TL820 device are sequential, with the lowest number being the drive physically located in the lowest position in the robot device.

Note

For the TL810 device, the order is reversed; the sequence begins from the highest position (top to bottom).

The tape drive names must be presented in the order in which they are connected in the tape jukebox. If any of the drive slots are empty, you must assign a dummy drive name as a place-

Managing Jukebox Devices Using MDMS

13.1 Working with Magnetic Tape Jukeboxes

holder. Do not assign the dummy drive name in the DRIVE_n symbol in media triplet. This prevents MDMS from selecting the dummy drive.

When MDMS selects drives for use, MDMS uses the index values within the list, not the actual drive names, to communicate with the drives. For any drives that you want MDMS to use, you must also identify those drives in a DRIVES_n symbol of a media triplet, where the order is not important.

For a TL820 jukebox with a symbol name of JUKEBOX4 on node NODE01:: and connected through a DSA controller such as an HSC, the symbol definitions in the file TAPESTART.COM might resemble the example shown in Example 13–5.

Example 13–5 Tape Jukebox Symbols for a TL820 Device

```
$ TAPE_JUKEBOXES := "JUKEBOX4"1

$ JUKEBOX4 := "NODE01::$2$DUA820:2 ,NODE01::$2$MUA25:3 ,NODE01::$2$MUA26:3
,NODE01::$2$MUA27:3 "
```

Where:

1 JUKEBOX4 is the name of the tape jukebox.

2 NODE01::\$2\$DUA820: is the NODE:: node name and robot device name.

3 NODE01::\$2\$MUA25:, NODE01::\$2\$MUA26:, and NODE01::\$2\$MUA27: are the three tape drives controlled by the robot device (NODE01::\$2\$DUA820:), with \$2\$MUA25: physically located on the bottom, \$2\$MUA26: next, and \$2\$MUA27: on top.

The following example shows how to define a media triplet so that MDMS selects the drives in the tape jukebox named JUKEBOX4:

```
$ MTYPE_2 := TK87_820

$ DENS_2 :=

$ DRIVES_2 := NODE01::$2$MUA25: ,NODE01::$2$MUA26: ,NODE01::$2$MUA27:
```

Note

For a media triplet, you only need to prefix the tape drive name with a NODE:: node name *if* the tape drive is remote.

13.1.6 Defining Multiple Tape Jukebox Symbols and Associated Media Triplets

Example 13–6 shows the tape jukebox symbols and media triplet assignments for the examples described in the previous sections. The assignments are made in the file TAPESTART.COM on node NODE01::.

Example 13–6 Multiple Tape Jukebox Symbols and Media Triplets

```
$ TAPE_JUKEBOXES := "JUKEBOX1, JUKEBOX2, JUKEBOX3, JUKEBOX4, GONK01, CLUST01"

$ JUKEBOX1 := "NODE01::$1$MIA5: ,NODE01::$1$MIA5:"

$ JUKEBOX2 := "NODE02::MKA301: ,NODE02::$3$MKA300:"

$ JUKEBOX3 := "NODE03::$1$DUA877: ,NODE03::$1$MUA25:"

$ JUKEBOX4 :=
"NODE01::$2$DUA820: ,NODE01::$2$MUA25: ,NODE01::$2$MUA26: ,NODE01::$2$MUA27:"
```

Managing Jukebox Devices Using MDMS

13.1 Working with Magnetic Tape Jukeboxes

```
$ GONK01 := "NODE04::MKA200,NODE04::NODE04$MKA300:,NODE04::NODE04$MKA400:"

$ CLUST01 := "NODE02::GKB101,NODE01::NODE02$MKB100:"

$ MTYPE_1 := TK856K

$ DENS_1 := COMP ! Separate media triplets needed if both COMP and NOCOMP
used

$ DRIVES_1 := $1$MIA5: ! local tape drive

$ MTYPE_2 := TK87K_820

$ DENS_2 := COMP ! Separate media triplets needed if both COMP and NOCOMP
used

$ DRIVES_2 := NODE01::$2$MUA25:,NODE01::$2$MUA26:,NODE01::$2$MUA27: ! RDF
served from NODE01::

$ MTYPE_3 := TK87K

$ DENS_3 := COMP ! Separate media triplets needed if both COMP and NOCOMP
used

$ DRIVES_3 := NODE02::$3$MKA300: ! RDF served from node NODE02::

$ MTYPE_4 := TK87_877

$ DENS_4 := COMP ! Separate media triplets needed if both COMP and NOCOMP
used

$ DRIVES_4 := NODE03::$1$MUA25: ! RDF served from node NODE02::

$ MTYPE_5 := TK87_810

$ DENS_5 := COMP ! Separate media triplets needed if both COMP and NOCOMP
used

$ DRIVES_5 := NODE04::NODE04$MKA300:,NODE04::NODE04$MKA400: !RDF served from
node NODE04::

$ MTYPE_6 := M_CLUST

$ DENS_6 := COMP ! Separate media triplets needed if both COMP and NOCOMP
used

$ DRIVES_6 := NODE04::NODE02$MKB100:
```

13.1.7 Using a Cleaning Cartridge in a Managed Jukebox

If you inventory a jukebox which includes cleaning cartridges, SLS MDMS will create records in the volume database that represent them. If your site operations include using the cleaning tapes, you must make them unavailable for allocation to a storage management application.

To avoid having SLS MDMS allocate a cleaning cartridge, use the `STORAGE ALLOCATE` command to allocate the cartridge to the `SYSTEM` or other suitable process for a distant time.

Use the following command:

```
$ STORAGE ALLOCATE /VOLUME=vol_id /USER_NAME=user /SCRATCH_DATE=date
```

Where:

Managing Jukebox Devices Using MDMS

13.2 Using TMSCP-Served Tape Devices

vol_id is the volume name of the cleaning cartridge. For example, CLN001.

date is the future date you determine.

user is the user name of the process that owns the cleaning cartridge. For example, SYSTEM.

13.2 Using TMSCP-Served Tape Devices

Due to restrictions in the underlying device support and device drivers, DSA-type robotic devices cannot be TMSCP-served to the OpenVMS Cluster. If you want to access magnetic tape jukeboxes from nodes other than the node that is connected either directly to the device or through a controller, you must access the device using a NODE:: assignment. The NODE:: specified must be the node name where the device is directly connected.

This is not true for the TL810- or TL820-type robotic devices. Those devices may be TMSCP-served to the OpenVMS Cluster system.

13.3 Using Magazines with Tape Jukeboxes in MDMS

Just as the MDMS volume database contains information about volumes, the MDMS magazine database contains information about magazines, the cartridges in those magazines, the number of slots in the magazine, and the state of the magazines (whether they are imported into a jukebox and, if so, where).

A **magazine** is a container with *n* slots (numbered 0 through *n*-1) that hold cartridges. You have to determine the number of slots in the magazine when you add it to the magazine database. The maximum number of slots allowed is 40.

Note

The TL810 does not include magazine functionality. However, the TL820 can function in either magazine mode or by handling individual cartridges.

The magazine database contains the following information:

- Magazine name
- Volume IDs
- Slot numbers
- Jukebox name (if the magazine is imported)

The magazine database file is located at:

```
SLS$MASTER:SLS$MAGAZINE_MASTER_FILE.DAT
```

If the magazine database file does not already exist, the SLS\$TAPMGRDB process automatically creates it when a magazine is added.

To use magazines, an operator places individual cartridge volumes into the magazine slots. The operator then places the magazine into the tape jukebox or, for seven-slot devices, into the receiver of the tape jukebox and closes the receiver. Once the magazine is in place and information is in the MDMS magazine database, MDMS can load and unload individual volumes from the magazine as needed using the robotics.

Table 13-6 describes the process for using magazines in an MDMS environment.

Table 13–6 Process for Using Magazines with Tape Jukeboxes

Stage	Activity		
1.	Verify the hardware and software will work together. See the SLS Software Product Description (SPD) for a list of supported devices and software requirements.		
2.	Add magazines to the magazine database. See Section 13.3.1.		
3.	Associate volumes with a magazine:		
	<table style="width: 100%; border: none;"> <tr> <td style="width: 50%; vertical-align: top;"> <p>Manually</p> <ol style="list-style-type: none"> 1. If the volume record is not already in the MDMS volume database, add the volume record <i>before</i> binding it to the magazine. For details about adding a volume to the MDMS volume database, see Section 15.5. 2. Bind volumes to a magazine and import the magazine into a jukebox. See Section 13.3.2 for instructions to manually bind volumes to a magazine. 3. After performing a manual bind operation, you must perform a STORAGE IMPORT MAGAZINE command on the magazine. <u>Restriction:</u> You cannot perform manual a bind operation on an imported magazine. </td> <td style="width: 50%; vertical-align: top;"> <p>Automatically</p> <ol style="list-style-type: none"> 1. Use the STORAGE IMPORT command to move the magazine into a jukebox. 2. Perform a STORAGE INVENTORY command on the magazine. See Section 13.3.3 for instructions. </td> </tr> </table>	<p>Manually</p> <ol style="list-style-type: none"> 1. If the volume record is not already in the MDMS volume database, add the volume record <i>before</i> binding it to the magazine. For details about adding a volume to the MDMS volume database, see Section 15.5. 2. Bind volumes to a magazine and import the magazine into a jukebox. See Section 13.3.2 for instructions to manually bind volumes to a magazine. 3. After performing a manual bind operation, you must perform a STORAGE IMPORT MAGAZINE command on the magazine. <u>Restriction:</u> You cannot perform manual a bind operation on an imported magazine. 	<p>Automatically</p> <ol style="list-style-type: none"> 1. Use the STORAGE IMPORT command to move the magazine into a jukebox. 2. Perform a STORAGE INVENTORY command on the magazine. See Section 13.3.3 for instructions.
<p>Manually</p> <ol style="list-style-type: none"> 1. If the volume record is not already in the MDMS volume database, add the volume record <i>before</i> binding it to the magazine. For details about adding a volume to the MDMS volume database, see Section 15.5. 2. Bind volumes to a magazine and import the magazine into a jukebox. See Section 13.3.2 for instructions to manually bind volumes to a magazine. 3. After performing a manual bind operation, you must perform a STORAGE IMPORT MAGAZINE command on the magazine. <u>Restriction:</u> You cannot perform manual a bind operation on an imported magazine. 	<p>Automatically</p> <ol style="list-style-type: none"> 1. Use the STORAGE IMPORT command to move the magazine into a jukebox. 2. Perform a STORAGE INVENTORY command on the magazine. See Section 13.3.3 for instructions. 		
4.	At this point, your system is prepared to work with MDMS for robotic loader functions. MDMS loads and unloads volumes from the magazine as needed.		
5.	To place a different magazine into the jukebox, or to physically remove the magazine, use the STORAGE EXPORT command to export the magazine. See Section 13.3.6.		
6.	If a magazine is no longer needed by MDMS, delete the magazine from the MDMS database. To do this, first export the magazine, unbind the volumes from the magazine, and then remove the magazine record from the MDMS volume database. See Section 13.3.7.		

13.3.1 Adding a Magazine

Before MDMS can load and unload volumes contained in a magazine, MDMS must know the magazine exists. To add a magazine to the magazine database, enter the STORAGE ADD MAGAZINE command in the following format:

```
$ STORAGE ADD MAGAZINE magazine_name /SLOTS=n
```

Result:

Managing Jukebox Devices Using MDMS

13.3 Using Magazines with Tape Jukeboxes in MDMS

This command adds a magazine name with the specified number of slots to the magazine database. MDMS now has a placeholder for storing information about that magazine.

13.3.2 Manually Binding Volumes to a Magazine

For MDMS to recognize and use volumes associated with a magazine, you first must add the volumes to the volume database (if they do not already exist) and then **bind** them to the magazine. Binding is the process by which you identify that a particular labeled volume resides in a particular slot of a particular magazine.

The bind operation updates the record in the magazine database with the volume IDs that are bound to the magazine.

Note

If you intend to use the manual BIND operation, the magazine to which the volumes are to be bound must not be imported into a jukebox.

Table 13–7 explains how to bind volumes to a magazine.

Table 13–7 How to Manually Bind Volumes to a Magazine

Step	Action
1.	Add the volumes using the STORAGE ADD VOLUME command. For example: <pre>\$ STORAGE ADD VOLUME AB0000 \$ STORAGE ADD VOLUME AB0001 \$ STORAGE ADD VOLUME AB0002 \$ STORAGE ADD VOLUME AB0003 \$ STORAGE ADD VOLUME AB0004 \$ STORAGE ADD VOLUME AB0005 \$ STORAGE ADD VOLUME AB0006</pre>
	This series of commands adds volumes AB0000 through AB0006 to the volume database. This assumes that these seven volumes did <i>not</i> already exist in the volume database.
	If you want to bind volumes already in the volume database to a new or different magazine, do not re-add the volumes to the database.

Managing Jukebox Devices Using MDMS 13.3 Using Magazines with Tape Jukeboxes

Table 13–7 How to Manually Bind Volumes to a Magazine

Step	Action
2.	<p>Use the STORAGE BIND command to bind the volumes to the magazine and assign slot numbers. For example:</p> <pre style="margin-left: 40px;">\$ STORAGE BIND AB0000 MAGFIN01/SLOT=0 \$ STORAGE BIND AB0001 MAGFIN01/SLOT=1 \$ STORAGE BIND AB0002 MAGFIN01/SLOT=2 \$ STORAGE BIND AB0003 MAGFIN01/SLOT=3 \$ STORAGE BIND AB0004 MAGFIN01/SLOT=4 \$ STORAGE BIND AB0005 MAGFIN01/SLOT=5 \$ STORAGE BIND AB0006 MAGFIN01/SLOT=6</pre> <p><u>Result:</u> Assumes that MAGFIN01 has been added previously using the STORAGE ADD MAGAZINE command and binds volumes AB0000 through AB0006 to magazine MAGFIN01. The volumes are assigned to the specified slots in the magazine.</p>

Once you have bound the volumes to the magazine, you use the STORAGE IMPORT MAGAZINE command to place the magazine into the jukebox. The default behavior for a STORAGE IMPORT MAGAZINE command is for MDMS to send an OPCOM request to physically place the magazine in the jukebox. MDMS waits for 2 minutes for a reply to this message, during which time the SLS\$TAPMGRRQ process is unable to process any new requests. The following example shows the import request and responses you see:

```
$ STORAGE IMPORT MAGA JMSMAG1 JUKEBOX1

%%%%%%%%%%%% OPCOM 22-DEC-1994 09:48:13.83 %%%%%%%%%%%%%

Request 130, from user SLS on REST

Place Magazine JMSMAG1 into Tape Jukebox JUKEBOX1; REPLY when DONE

09:48:22.53, request 130 was completed by operator _REST$RTA1:

%SLS-S-MAGVOLIMP, magazine volume JMS3 imported into tape jukebox

%SLS-S-MAGVOLIMP, magazine volume JMS1 imported into tape jukebox

$
```

If you add the /NOASSIST qualifier to the STORAGE IMPORT MAGAZINE command, MDMS assumes the magazine is already in the jukebox and does not wait for it to be placed. MDMS displays messages indicating which volumes are in the magazine so you know the magazine has been imported, as illustrated in the following example:

```
$ STORAGE IMPORT MAGA JMSMAG1 JUKEBOX1 /NOASSIST

%SLS-S-MAGVOLIMP, magazine volume JMS3 imported into tape jukebox

%SLS-S-MAGVOLIMP, magazine volume JMS1 imported into tape jukebox

$
```

Managing Jukebox Devices Using MDMS

13.3 Using Magazines with Tape Jukeboxes in MDMS

Note

The STORAGE IMPORT MAGAZINE command does not work with magazines attached to remote devices. You can only use the STORAGE IMPORT and STORAGE EXPORT MAGAZINE commands for local devices.

13.3.3 Automatically Binding Volumes to a Magazine

MDMS can automate the bind process by obtaining the volume label of each cartridge in a tape jukebox and by mounting each individual cartridge in a magazine. The volume label is obtained by either mounting each cartridge or, if the tape jukebox has a VISION system, obtaining label information from each cartridge's bar-code. MDMS updates the magazine and volume databases as appropriate. This process is called an **inventory**.

To use the STORAGE INVENTORY JUKEBOX command, the magazine must exist in the magazine database and be physically accessible to MDMS through the STORAGE IMPORT MAGAZINE command.

Restriction:

This is not true for TL810 devices. With the TL810 device, you can only use the STORAGE IMPORT CARTRIDGE and STORAGE EXPORT CARTRIDGE commands instead of a STORAGE IMPORT MAGAZINE command.

Assuming the magazine is created and has labeled cartridges loaded in it, enter the STORAGE IMPORT MAGAZINE and STORAGE INVENTORY JUKEBOX commands in the following format:

```
$ STORAGE IMPORT MAGAZINE magazine_name jukebox_name
```

```
$ STORAGE INVENTORY JUKEBOX jukebox_name
```

Result:

The STORAGE IMPORT MAGAZINE command imports the magazine *magazine_name* into jukebox *jukebox_name*.

The STORAGE INVENTORY JUKEBOX command does the following:

- Binds the volumes located in the magazine to the magazine
- Assigns the magazine slot numbers to the volumes bound to the magazine
- Updates the magazine and volume databases

Note

Each STORAGE INVENTORY JUKEBOX operation takes from seconds to portions of an hour to complete, depending on the hardware. During this time, the SLS\$TAP-MGRRQ process on the node where the tape device is connected is unable to process any new requests, because it is waiting for the inventory to complete.

To avoid problems, perform inventory commands when you expect MDMS activity to be at a minimum or use the STORAGE BIND command.

Restrictions:

- The STORAGE INVENTORY MAGAZINE command does not work with magazines attached to remote devices. You can only IMPORT and EXPORT magazines attached to local devices.

Managing Jukebox Devices Using MDMS

13.3 Using Magazines with Tape Jukeboxes

- If you perform a STORAGE INVENTORY JUKEBOX command on a tape device equipped with a VISION system, such as a TL810 or TL820, the behavior is somewhat different. On a VISION system, MDMS relies on the robot's inventory in RAM to determine what is in the tape jukebox. MDMS does not load and mount the volumes to read the labels. On VISION systems, you must have external bar-code labels on all volumes and the last 6 characters on the bar-code labels must match the internal volume label.

More information:

Refer to the for additional information and restrictions for the STORAGE INVENTORY JUKEBOX command.

13.3.4 Using Multiple Magazines in Single and Multitower Jukeboxes.

If you use a TL82*n* automated tape library or if you use a multitower TL82*n* configuration, and use the bin packs as magazines, you must follow specific bin and slot numbering conventions.

The bin numbering convention is necessary for importing magazines. The slot numbering convention is used by MDMS when you inventory the jukebox, or if you have a need to address a particular cartridge by its slot number.

13.3.4.1 Bin Numbering Convention

The bin numbering convention requires three pieces of information:

- Face number, from 0 through one less than the total number of faces in the jukebox configuration
- Bin location, starting with A at the top, and working through B and possibly C at the bottom of the face
- Face Size, which is the total number of cartridges that one face can hold. Multiply the number of slots in a bin by the number of bins a face can hold.

The syntax for the expression is as follows:

`N,X_N`

For example, the location of the bottom bin on the third face of a TL820 automated tape library would be described as:

`2,C_33`

13.3.4.2 How to Calculate the Slot Numbers When Using Multiple Magazines

Follow the steps in Table 13–8 to determine slot numbers for cartridges in multiple magazine implementations.

Table 13–8 Calculating Slot Numbers

Step	Action
1.	Multiply the number of slots in a bin by the number of bins that can be held by one face of the jukebox.
2.	Multiply the result of Step 1 by the face number. Faces are numbered from 0 through 7.
3.	Subtract 1 from the bin number. Bins are numbered from 1, from the top of the face.

Managing Jukebox Devices Using MDMS

13.3 Using Magazines with Tape Jukeboxes in MDMS

Table 13–8 Calculating Slot Numbers

Step	Action
4.	Multiply the result of Step 3 by the number of slots in the bin.
5.	Add the result of Step 4 to the slot number in the bin. Slots are numbered from 1 from the top of the bin.
6.	Add the result of Step 2 to the result of Step 5.
7.	Subtract 1 from the result of Step 6.

13.3.5 Loading and Unloading Volumes in a Jukebox

Once you have added volumes, added magazines, and bound the volumes and magazines together, MDMS recognizes the volumes are contained in the appropriate jukebox. MDMS loads and unloads volumes as needed. Whether a

given volume is in a magazine becomes invisible to the MDMS user application. The only time human interaction is required is when MDMS needs a volume to be physically removed from or placed into the tape jukebox.

13.3.6 Physically Removing a Magazine from a Jukebox

It may become necessary for you to remove a magazine from a jukebox. To request that MDMS allow you to remove a magazine from a jukebox, enter the STORAGE EXPORT MAGAZINE command in the following format:

```
$ STORAGE EXPORT MAGAZINE magazine_name
```

MDMS sends an OPCOM request to physically remove the magazine from the jukebox. No reply is needed.

The following example shows an export message:

```
$ STORAGE EXPORT MAGA JMSMAG1

%%%%%%%%%%%% OPCOM 22-DEC-1994 09:50:00.38 %%%%%%%%%%%%%

Message from user SLS on REST

Remove Magazine JMSMAG1 from Tape Jukebox JUKEBOX1

%SLS-S-MAGVOLEXP, magazine volume JMS3 exported from tape jukebox

%SLS-S-MAGVOLEXP, magazine volume JMS1 exported from tape jukebox

$
```

13.3.7 Removing Magazines from Use

For any number of reasons, you may need to stop MDMS from using a particular magazine. To do this, perform the following steps:

1. Export the magazine if needed.
2. Unbind any volumes currently bound to the magazine.
3. Remove the magazine from the MDMS magazine database.

Managing Jukebox Devices Using MDMS

13.3 Using Magazines with Tape Jukeboxes

Unbinding volumes from a magazine

To unbind volumes from the magazine database, enter the STORAGE UNBIND command in the following format:

```
$ STORAGE UNBIND volume_name magazine_name
```

Result:

This command unbinds volume *volume_name* from magazine *magazine_name* in the magazine database. The volume IDs remain in the volume database. After the magazine is physically removed from the jukebox, the operator physically removes the volumes from the magazine. You should physically remove the cartridges from the magazine slots to keep the physical contents of the magazine consistent with that described by the magazine database.

Restriction:

You cannot unbind a volume from an imported magazine.

13.3.8 Removing a Magazine from the MDMS Magazine Database

To remove the magazine name from the MDMS magazine database, enter the STORAGE REMOVE MAGAZINE command in the following format:

```
$ STORAGE REMOVE MAGAZINE magazine_name
```

Restrictions:

- You cannot remove a magazine from the magazine database if it still has volumes bound to it.
- You cannot remove a magazine that is imported into a jukebox. You must enter a STORAGE EXPORT MAGAZINE command before entering the STORAGE REMOVE MAGAZINE command.

13.3.9 Showing Magazine Information

To find out what magazines are in the MDMS magazine database, enter the following command:

```
$ STORAGE SHOW MAGAZINE
```

Result:

MDMS displays all magazines in the MDMS magazine database and identifies those magazines currently located in a tape jukebox:

Managing Jukebox Devices Using MDMS

13.3 Using Magazines with Tape Jukeboxes in MDMS

Magazine Name	Tape Jukebox Name	Tape Jukebox Start Slot	Magazine Size
BARBMAG	Not imported		11 slots
EMPTYMAG	Not imported		7 slots
JMSMAG1	JUKEBOX1	0	7 slots
KYLERMAG	Not imported		7 slots
LMSMAG1	Not imported		7 slots
MAG5	Not imported		5 slots
MBSMAG1	Not imported		7 slots
MBSMAG2	Not imported		7 slots

13.3.10 Showing Volumes in a Magazine

To show volumes bound to a magazine, use the `STORAGE SHOW MAGAZINE` command. In the following example, the magazine name is `JMSMAG1`.

```
$ STORAGE SHOW MAGAZINE JMSMAG1
```

Result:

MDMS shows all volumes associated with the specified magazine:

Magazine Slot	Jukebox Slot	Volume ID	Volume Type	Volume State	Volume Location
0	0	JMS3	SLS Volume	Allocated	In Drive
1	1	JMS1	SLS Volume	Free	In Slot
2	2		Slot empty		
3	3		Slot empty		
4	4		Slot empty		
5	5		Slot empty		
6	6		non-SLS Volume		

Note that empty slots are listed as well as any non-MDMS volumes contained in the magazine.

13.3.11 Using Magnetic Tape Jukeboxes with Individual Cartridges

As mentioned previously, for the TL810 and TL820 jukeboxes, you can work with individual cartridges also. The following sections explain how to physically move individual cartridges in and out of these jukeboxes.

13.3.11.0.1 Importing Cartridges Into a TL820 Jukebox –

To import individual cartridges into a TL820 jukebox, use the `STORAGE IMPORT CARTRIDGE` command in the following format:

```
$ STORAGE IMPORT CARTRIDGE volume_name jukebox_name
```

Managing Jukebox Devices Using MDMS

13.3 Using Magazines with Tape Jukeboxes

Result:

Once you have issued this command, MDMS displays an OPCOM message and illuminates the tape jukebox's import slot door button.

Perform the following steps:

1. Push the button; the import door opens.
2. Insert the cartridge in the import area.
3. Close the door.

Note

You do not need to respond to the OPCOM messages. MDMS handles the tape import operations from this point forward.

Restrictions:

The following restrictions apply when importing cartridges into the tape jukebox:

- A slot in the tape jukebox must be free.
- The volume name first must be in the volume database, unless you use the /ADD qualifier.
- The tape jukebox name must be known to MDMS through the symbol definitions in the file TAPESTART.COM.
- The cartridges must contain a bar-code label.

13.3.11.1 Importing a Cartridge Into a TL810 Jukebox

Use the following procedure to import a cartridge into the TL810:

1. Press the OPEN button. This causes the port door to open.
2. Place the cartridge in the top slot. Wait for the jukebox to finish initializing before going to Step 3.
3. Press the OPEN button and wait for the display to indicate that the door can be closed. When the "Please Operate" message is displayed, close the door.
4. When the device has completed the initializing, execute the STORAGE IMPORT CARTRIDGE command. Ignore the OPCOM message that says you have 1 minute to place the cartridge in the in port. This message requires no replies. When the system prompt is returned, the import operation is complete.
5. The cartridges must contain a bar-code label.

13.3.11.1.1 Exporting cartridges from a TL820 jukebox To export individual –

To export individual cartridges from a TL820 jukebox, enter the STORAGE EXPORT CARTRIDGE command in the following format:

```
§ STORAGE EXPORT CARTRIDGE volume_name jukebox_name
```

Result:

Once you have issued this command, the jukebox exports the cartridge to an export area. Remove the cartridge from the export area.

13.3.11.1.2 Exporting A Cartridge from a TL810 To export a cartridge from a – TTL810, use the following procedure:

1. Enter the STORAGE EXPORT CARTRIDGE command.

Managing Jukebox Devices Using MDMS

13.4 Operating Tape Jukeboxes as Stack Loaders

2. When the system prompt is returned, press the OPEN button on the TL810 to open the port door; remove the cartridge.

13.4 Operating Tape Jukeboxes as Stack Loaders

Although the information in this chapter focuses on operating your tape jukeboxes as robotic devices, MDMS allows you to operate these devices as stack loaders as well. Whether your tape jukebox functions as a robotic device or a stack loader depends entirely on how you configure the device in the file TAPESTART.COM:

- If you assign the device to the TAPE_JUKEBOXES symbol, the device operates as a robotic device.
- If you assign drives in the device only in media triplets, then it operates as a stack loader.

Restriction:

A TL810 class or T1820 class device cannot be operated as a stack loader.

13.5 Resolving Jukebox Problems

The following sections describe two areas in which working with jukeboxes requires some special attention.

13.5.1 Separating Software and Hardware Tape Movement Requests

You can move cartridges in a loader from the loader into the drive using other mechanisms besides MDMS. This is not a problem if the tape jukebox is being used as a stack loader. In this case, MDMS does not issue any robotic load commands to the drive.

However, if a loader has been configured for MDMS to use as a robotic device, then you must be careful to avoid moving cartridges in and out of the magazines outside of MDMS.

Moving cartridges should be restricted to MDMS commands such as STORAGE LOAD and STORAGE UNLOAD. This restriction exists because, on some drives, the tape firmware will stop accepting MDMS robotic cartridge movement commands after hardware-oriented cartridge movement commands have been executed.

Hardware-oriented cartridge movement commands occur when:

- On DLT loaders (TZ8x7, TA8x7, TF8x7 devices):
- A magazine is physically loaded into the drive's receiver and the door is closed while the 4-position key switch is in either the LOCKED position or the SYSTEM position.
- On TZ8x5 devices:

A magazine is physically loaded into the drive's receiver and the door is closed. The position of the keyswitch has no effect on the operation on the loader from the MDMS interface.

LOCKED: identified by a symbol of a padlock

SYSTEM: identified by a symbol of a rectangle with arrows on the perimeter.

MANUAL: identified by a symbol of a hand.

REPAIR: identified by a symbol of a wrench (spanner).

Always leave the key in the MANUAL position when closing the door. After the loader's elevator module has examined all the cartridges in the drive, and the drive is quiet, you can move the key to the LOCKED position and remove the key.

Managing Jukebox Devices Using MDMS

13.6 Using a TL800 Class Jukebox

- The front panel Slot Select and Load/Unload buttons are used to manually select a numbered slot and load or unload a cartridge.
- A cartridge in the drive is dismounted using the DCL DISMOUNT/UNLOAD command. Note that /UNLOAD is the default on a DISMOUNT command. To dismount cartridges in DLT loaders controlled by MDMS, use the /NOUNLOAD qualifier. You can move cartridges out of the drive by issuing a STORAGE UNLOAD DRIVE or STORAGE UNLOAD VOLUME command. For more information, see the

13.5.2 Identifying Unrecoverable Robotic Control Errors

The robotic control software reports several errors that are caused by device conditions from which MDMS cannot recover. The most common cause of these conditions is the execution of hardware cartridge movement commands when a tape jukebox was intended to be used under robotic control. MDMS commands such as STORAGE LOAD, STORAGE UNLOAD, or system backup operations can return one of the following errors when this occurs:

```
%SLS-F-MRD_XXX_FAIL, media robot driver xxx failure
```

```
%SYSTEM-F-ILLIOFUNC, illegal I/O function code
```

```
%SYSTEM-F-CTRLERR, fatal controller error
```

```
%SYSTEM-F-DRVERR, fatal drive error
```

To correct these conditions, turn off the power to the tape jukebox, wait approximately 5 seconds, and then reapply power to the drive. If the problem persists, report the problem through your usual support channels.

Recommendation:

For a TL810 or TL820 device, do not power the device off or on until you have first determined the cause of the problem.

13.6 Using a TL800 Class Jukebox

The TL800 class jukeboxes incorporate features of a library and features of a loader. Because of this, HP recommends that you follow prescribed procedures for using a TL800 class jukebox for operations using MDMS.

13.6.1 TL800 Jukebox Features and What They Mean

Front Panel Controls —

Using the TL800 class jukeboxes requires that you first make sure front panel settings are consistent with MDMS requirements. Refer to the hardware documentation for information describing how to manipulate the front panel controls.

Cartridge Magazine —

You must use a magazine to import and store the cartridges while they are available to the drive in the jukebox. You will be required to register the magazine in the MDMS database before you can use the jukebox for MDMS assisted operations. You will also be required.

Vision System —

The TL800 class jukebox incorporates a vision system capable of reading bar code labels on the cartridges. This capability allows you to inventory its contents more rapidly than a jukebox that doesn't have a vision system.

13.6.2 Recommended Hardware Settings

The media handling procedures in this document were qualified on a TL891

Managing Jukebox Devices Using MDMS

13.6 Using a TL800 Class Jukebox

jukebox with the following hardware settings. Other hardware settings relating to SCSI addressing are not considered.

Library Settings:

- Library Mode—Random
- Library Config—Standalone
- Unload Mode—Implicit

DLT Setting:

- Operate Handle—Yes

Refer to the hardware documentation for details on defining or validating these settings.

13.6.3 Using Uncataloged Media with a TL800 Class Jukebox

The process described here gives the steps involved with using uncataloged media into a TL800 class jukebox, such as the TL891.

If you acquire or purchase media and prepare it ahead of time, this process could apply to you. This process outlines the general steps for moving media into the jukebox for use. Because MDMS can automatically enter records in the database for each cartridge during the inventory operation, preparations for this process are minimal, and can be performed on large numbers of cartridges at one time.

This process description assumes you are beginning with cartridges that have labels attached and that have been initialized, but are not yet cataloged in the MDMS database.

Refer to Table 13–9 for the process describing how to add uncataloged media while importing it for use in a TL800 class jukebox.

Table 13–9 Using Uncataloged Media with a TL800 Class Jukebox

Stage	Action
1.	Fill the magazine with cartridges. Make sure that the cartridges have bar-coded labels.
2.	Make sure the magazine has an entry in the MDMS database, or create one. Check the magazine in the database. <pre>\$STORAGE SHOW MAGAZINE <i>magazine_name</i></pre> Create a magazine record if none exists in the database. <pre>\$STORAGE ADD MAGAZINE <i>magazine_name</i> /SLOTS=10</pre> <u>Where:</u> <i>magazine_name</i> is the name of the magazine with which you are working.
3.	Issue the following command to load the magazine into the jukebox. If you require an operator to load the magazine and reply, then do not use the /NOASSIST qualifier. <pre>\$ STORAGE IMPORT MAGAZINE <i>magazine_name</i> <i>tape_jukebox_name</i> /NOASSIST</pre> <u>Where:</u> <ul style="list-style-type: none">• <i>magazine_name</i> is the name of the magazine with which you are working.• <i>tape_jukebox_name</i> is the name of the jukebox with which you are working.
4.	Physically place the magazine into the loader.

Table 13–9 Using Uncataloged Media with a TL800 Class Jukebox

Stage	Action
5.	Inventory the jukebox with the following command. <pre style="margin-left: 40px;">\$ STORAGE INVENTORY JUKEBOX <i>tape_jukebox_name</i> /ADD/MEDIA_TYPE=<i>media_type_name</i></pre> <p><u>Where:</u></p> <ul style="list-style-type: none"> • <i>tape_jukebox_name</i> is the name of the jukebox with which you are working. • <i>media_type_name</i> is the name of the defined media type for the cartridges. <p>This action automatically adds volume records for the cartridges and binds them to the magazine.</p>
6.	Use the media. Your storage management application loads and unloads the media until it makes sense to remove it and add more.
7.	To remove the magazine and its media from the jukebox, issue the following command. <pre style="margin-left: 40px;">\$ STORAGE EXPORT MAGAZINE <i>magazine_name</i></pre> <p><u>Where:</u> <i>magazine_name</i> is the name of the magazine with which you are working.</p>
8.	Physically remove the magazine from the loader.

At this point, you can unbind the cartridges from the magazine or leave them bound to the magazine; depending on your operational requirements.

13.6.4 Using Cataloged Media with a TL800 Class Jukebox

The process described here gives the steps involved with using cataloged media with a TL800 class jukebox, such as the TL891.

When you use cartridges that are already cataloged in the MDMS database, you must do some things differently to use them with the jukebox. The INVENTORY operation will not automatically bind the cartridges to the magazine, so you will have to do that manually.

Refer to Table 13–10 for the process describing how to incorporate cataloged media

Table 13–10 Using Cataloged Media with a TL800 Class Jukebox

Stage	Action
1.	Fill the magazine with cartridges.
2.	Make sure the magazine has an entry in the MDMS database, or create one. Check the magazine in the database. <pre style="margin-left: 40px;">\$STORAGE SHOW MAGAZINE <i>magazine_name</i></pre> <p>Create a magazine record if none exists in the database. <pre style="margin-left: 40px;">\$STORAGE ADD MAGAZINE <i>magazine_name</i> /SLOTS=10</pre> <p><u>Where:</u> <i>magazine_name</i> is the name of the magazine with which you are working.</p> </p>

Managing Jukebox Devices Using MDMS

13.7 Working with DCSC-Controlled Robotic Silos

Table 13–10 Using Cataloged Media with a TL800 Class Jukebox

Stage	Action
3.	<p>Bind the cartridges to the magazine. Issue this command for each cartridge contained in the magazine, specifying the slot number:</p> <pre>\$ STORAGE BIND <i>volume_id</i> <i>magazine_name</i> /SLOT=<i>n</i></pre> <p><u>Where:</u></p> <ul style="list-style-type: none">• <i>volume_id</i> is the name on the label attached to the cartridge.• <i>magazine_name</i> is the name of the magazine with which you are working.• <i>n</i> is the number of the slot occupied by the cartridge.
4.	<p>Issue the following command to load the magazine into the jukebox.</p> <pre>\$ STORAGE IMPORT MAGAZINE <i>magazine_name</i> <i>tape_jukebox_name</i> /NOASSIST</pre> <p><u>Where:</u></p> <ul style="list-style-type: none">• <i>magazine_name</i> is the name of the magazine with which you are working.• <i>tape_jukebox_name</i> is the name of the jukebox with which you are working.
5.	<p>Physically place the magazine into the loader.</p>
6.	<p>Use the media. Your storage management application loads and unloads the media until it makes sense to remove it and add more.</p>
7.	<p>To remove the magazine and its media from the jukebox, issue the following command.</p> <pre>\$ STORAGE EXPORT MAGAZINE <i>magazine_name</i></pre> <p><u>Where:</u> <i>magazine_name</i> is the name of the magazine with which you are working.</p>
8.	<p>Physically remove the magazine from the loader.</p>

13.7 Working with DCSC-Controlled Robotic Silos

MDMS, combined with the Digital Cartridge Server Component (DCSC) software, provides automated storage management. By setting up user authorization to volume pools within the MDMS software, you can have an automated storage management system using MDMS, the DCSC software, and the StorageTek Automated Cartridge System (ACS) 4400 or StorageTek WolfCreek silo.

Note

DCSC is not supported on systems running OpenVMS Version 7.1.

The StorageTek ACS 4400 is a combined hardware and software entity that provides storage and access for up to 6,000 cartridges. Command-oriented access to the ACS is provided by DCSC software. MDMS uses the DCSC software to provide automated storage management.

More information:

For more information about DCSC, see the following documentation:

- *Digital Cartridge Server Component for OpenVMS Installation Guide*
- *Digital Cartridge Server Component for OpenVMS User's Guide*
- *Digital Cartridge Server Component for OpenVMS System Manager's Guide*

- *Digital Cartridge Server Component for OpenVMS Programmer's Reference Guide*

13.7.1 Customizing TAPESTART.COM for DCSC-Controlled Silos

To enable MDMS to operate with DCSC software, you must modify the following symbols in the file TAPESTART.COM:

- **DCSC_DRIVES**—Identifies the tape devices MDMS will use with DCSC in the silo.
- **MTYPE_n**—Identifies the media type to use for the silo.
- **DENS_n**—Identifies the density for the media type.
- **DRIVES_n**—A list of specific drives in the silo for MDMS to use.
- **DCSC_n_NODE**—If the silo is located on a remote system, you must assign the node name to this symbol. The *x* indicates the library number.

13.7.1.1 DCSC_DRIVES Symbol

You must assign all tape devices managed by the DCSC software to the DCSC_DRIVES symbol.

For example, if the tape devices \$1\$MUA0, \$1\$MUA1, \$1\$MUA2, and \$1\$MUA3 are managed by the DCSC software, then assign:

```
$ DCSC_DRIVES := $1$MUA0, $1$MUA1, $1$MUA2, $1$MUA3
```

This symbol assignment allows MDMS to determine which tape devices to automatically load. If the drives are remote, you must include the node name.

(DCSC tape devices appear to the OpenVMS operating system as TA90 or TA90E tape devices.)

13.7.1.2 Media Triplet for DCSC Tape Devices

MDMS has to determine which tape devices can service a given media type.

Define a media triplet for tape devices managed by the DCSC software. The following media triplet format is recommended:

```
$ MTYPE_n1 := DCSC_n2  
  
$ DENS_n1 :=  
  
$ DRIVES_n1 := list_of_drives3
```

Where:

1. *n* is a unique number for the media triplet to use for DCSC volumes.
2. *n* is a unique number (1 to 4) indentifying the ACS library of the volumes. This supports multiple libraries (up to four).
3. *list_of_drives* is a list of tape devices within the silo, separated by commas.

For example, tape devices managed by the DCSC software are defined in the symbol DCSC_DRIVES. The media triplet number 6 is unused. Define a DCSC media triplet as follows:

```
$ MTYPE_6 := DCSC_1  
  
$ DENS_6 :=  
  
$ DRIVES_6 := $1$MUA0, $1$MUA1, $1$MUA2, $1$MUA3
```

Assigning more than one DCSC-controlled silo:

Managing Jukebox Devices Using MDMS

13.7 Working with DCSC-Controlled Robotic Silos

If your system accesses more than one DCSC-controlled silo, then assign separate media triplets for each silo.

13.7.1.3 DCSC_n_NODE Symbol

If the silo is on a remote node, you must enable MDMS to locate the node where the DCSC-controlled silo resides. You must assign the node name to the `DCSC_n_NODE` symbol. The *n*th value is the same as the *n*th value assigned to the `DCSC_n` symbol in the media triplet.

The following example assigns the media type `DCSC_1` to the node `MERKUR`.

```
$ DCSC_1_NODE := MERKUR
```

13.7.2 MDMS Functions Associated with DCSC-Controlled Silos

MDMS uses DCSC to perform functions in DCSC-controlled silos. You can use `STORAGE` commands or the ACS Management Menu to access MDMS functions for the silos.

13.7.2.1 STORAGE Commands for Silos

The following `STORAGE` commands provide special functionality for DCSC-controlled silos:

1. `INVENTORY ACS`—MDMS can verify that a specific range of volumes exists in the silo, and optionally adds records to the volume database for each volume found within a specified range.
2. `IMPORT ACS`—Adds cartridges into the silo, and optionally adds records to the MDMS volume database for each volume found.
3. `EXPORT ACS`—Physically ejects a cartridge from the silo, either for off-site storage or to discard. MDMS provides this function to move the cartridge to the cartridge **access port** where it can then be removed.
4. `LOAD`—MDMS initiates a `LOAD` sequence in the silo when:
 - A user initiates a `STORAGE LOAD` command
 - A client application of MDMS (such as Archive/Backup System for OpenVMS) needs to access a file stored on a volume resident in the silo
5. `UNLOAD`—An `UNLOAD` sequence is initiated in the silo when MDMS is finished with a volume.

13.7.3 Identifying the Volumes in a DCSC-Controlled Silo

To verify that a volume or range of volumes is in a silo, use the `STORAGE INVENTORY ACS` command. The `INVENTORY ACS` command adds volumes found in the silo to the MDMS volume database.

13.7.4 Adding Volumes to a DCSC-Controlled Silo

To physically bring volumes from the silo's cartridge access port to a slot inside the silo, use the `STORAGE IMPORT ACS` command. This causes the MDMS volume database to be updated. If you specify the `/ADD` qualifier, any new volumes not already in the MDMS database are added.

13.7.5 Removing Volumes from a DCSC-Controlled Silo

To physically remove volumes from the silo through the cartridge access port, use the `STORAGE EXPORT ACS` command.

13.7.6 ACS Management Menu

The ACS Management Menu provides options that let you control the behaviors of DCSC-controlled robotic silos from MDMS. Figure 13–2 shows the options available on the ACS Management Menu.

Figure 13–2 ACS Management Menu

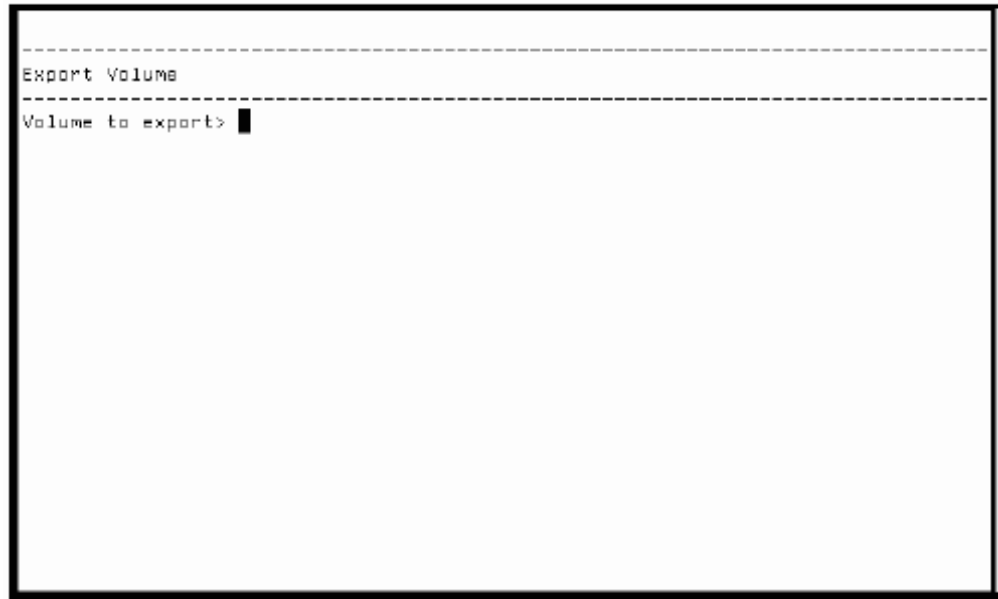

CXC-3344A

The following functions are available on the ACS Management Menu:

1. Inventory Volume Series—Inventories a series of volumes into the silo.
2. Import Volume(s)—Imports one or more volumes into the silo.
3. Initialize Volume Series—Initialize a series of existing volumes in the silo.
4. Load Volume Onto Drive—Automatically loads a volume onto a drive in a silo.
5. Unload Drive—Unloads a volume from a specific drive.
6. Unload Volume—Unloads a specific volume from a drive.
7. Export Volume—Exports a volume from the silo.

13.7.6.1 ACS Management Menu: Inventory Volume Series

If volumes were previously imported into the ACS with the /NOADD qualifier, MDMS will not be able to use them. To enable MDMS software to use these volumes, you must inventory them. To inventory volumes that already exist in the ACS, use either the STORAGE INVENTORY command or the Inventory Volume Series option.

13.7.6.2 Inventory Volume Series Screen Diagram

The Inventory Volume Series option displays a screen that enables you to inventory a series of volumes in the ACS.

Figure 13–3 illustrates the Inventory Volume Series screen.

Managing Jukebox Devices Using MDMS

13.7 Working with DCSC-Controlled Robotic Silos

Figure 13–3 Inventory Volume Series

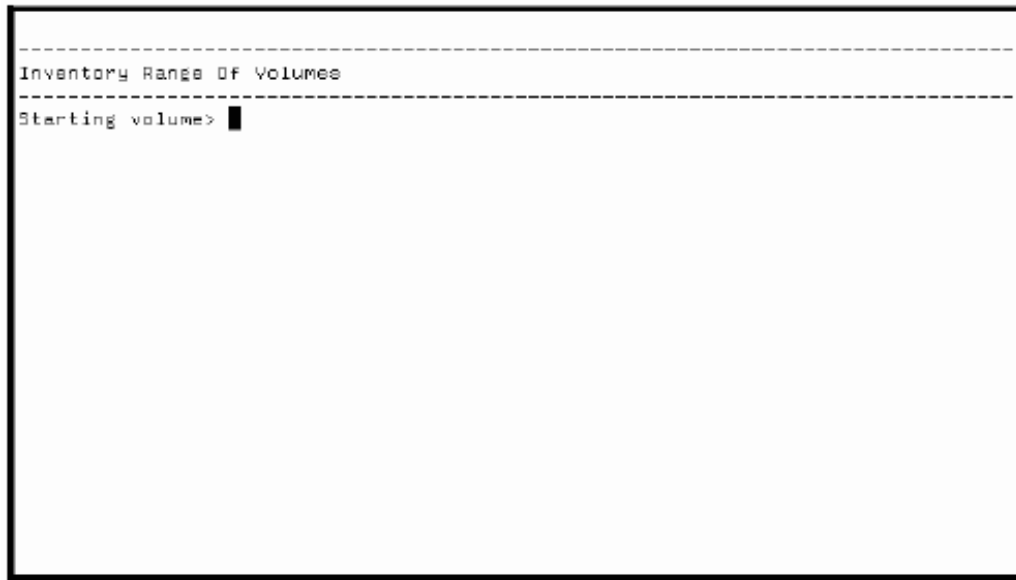

CXO-3347A

13.7.6.3 How To Use The Inventory Volumes Series Option

Perform the steps described in Table 13–11 to use the Inventory Volume Series option.

Table 13–11 Inventorying Volume Series

Step	System Prompt	Action
1.	–	Enter option 14 from the Operator Menu and press Return . <u>Result:</u> The software displays the DCSC Management Menu.
2.	–	Enter option 1 from the ACS Management Menu and press Return . <u>Result:</u> The software displays the Inventory Volume Series screen (Figure 13–3).
3.	Starting volume>	Enter the name of the starting volume in the series.
4.	Ending volume>	Enter the name of the ending volume in the series. The starting and ending volume names must have the same number of characters and the ending volume must be later in the sequence (greater than or equal to) the starting volume.
5.	Automatically add volumes to MDMS database if not found? [YES]>	Enter YES or NO and press Return . Default is YES. <u>Result:</u> Volumes found will be updated. If YES is entered, then if a volume is not found in the MDMS volume database, it will be automatically entered; else, a warning is issued.
6.	Which ACS library? [0]>	Enter 0 to accept the default library or enter the correct library id and press Return .

Table 13–11 Inventorying Volume Series

Step	System Prompt	Action
7.	Action for missing volumes (QUIT, EXPORT, REMOVE)? [QUIT]	Enter QUIT to select the default. Enter EXPORT to change the location of the missing volumes, or enter REMOVE to remove the missing volumes' record from the ACS library.

Example

Inventory Range Of Volumes

```
Starting volume> sq0800 Return 1
Ending volume> sq0801 Return 2
Automatically add volumes to MDMS database if not found? [YES] Return 3
Calling MDMS to inventory SQ0800 through SQ0801... 4
%SLS-S-VOLINVENTORIED, volume SQ0800 inventoried 5
%SLS-S-VOLADDED, volume SQ0800 added to MDMS database 6
%SLS-S-VOLINVENTORIED, volume SQ0801 inventoried 7
%SLS-S-VOLADDED, volume SQ0801 added to MDMS database 8
```

1 The operator specifies the starting volume name of SQ0800.
2 The operator specifies the ending volume name of SQ0801.
3 The operator wants volumes that are unknown to MDMS to be automatically added to the MDMS volume database.
4 MDMS software is called to perform the inventory.
5 Volume SQ0800 was found in the ACS.
6 SQ0800 was added to the MDMS volume database.
7 Volume SQ0801 was found in the ACS.
8 SQ0801 was added to the MDMS volume database.

13.7.6.4 ACS Management Menu: Import Volume(s)

The Import Volume(s) option displays a screen that enables you to physically import one or more volumes into the ACS. ACS reports the labels to the MDMS software, and optionally allows you to add the volume record to the MDMS volume database.

13.7.6.5 Import Volume(s) Screen Diagram

Figure 13–4 illustrates the Import Volume(s) screen.

Managing Jukebox Devices Using MDMS

13.7 Working with DCSC-Controlled Robotic Silos

Figure 13–4 Import Volume(s) Screen

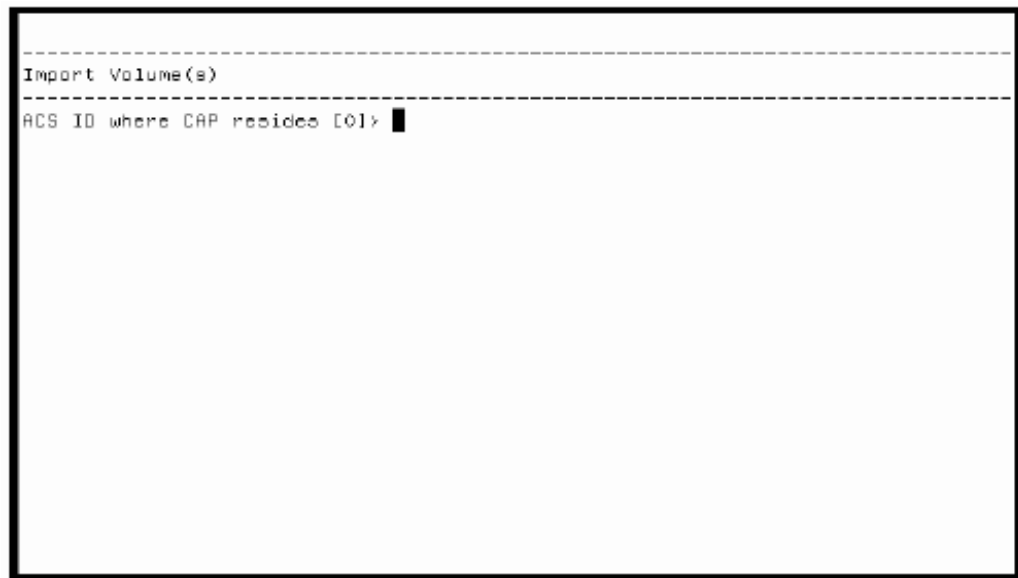

CXC-3345A

13.7.6.6 How To Use The Import Volume Option

Perform the steps described in Table 13–12 to use the Import Volume(s) option.

Table 13–12 Importing Volumes

Step	System Prompt	Action
1.	–	Enter option 14 from the Operator Menu and press Return . <u>Result:</u> The software displays the DCSC Management Menu.
2.	–	Enter option 2 from the ACS Management Menu and press Return . <u>Result:</u> The software displays the Import Volume(s) screen. (Figure 13–4).
3.	ACS library for import [0]>	Enter the correct library ID or press Return to select the default library ID of 0.
4.	ACS ID where CAP resides [0]>	Enter the ID of the ACS or press Return to select the default ID of 0.
5.	LSM ID where CAP resides [0]>	Enter the ID of the LSM and press Return . Default is 0.
6.	Automatically add volumes to the MDMS database if not found? [YES]>	Enter YES or NO and press Return . Default is YES. <u>Result:</u> Volumes found will be updated. If YES is entered, then if a volume is not found in the MDMS volume database, it will be automatically entered; else a warning is issued.

Managing Jukebox Devices Using MDMS 13.7 Working with DCSC-Controlled Robotic

Table 13–12 Importing Volumes

Step	System Prompt	Action
7.	–	Open the CAP door when instructed to do so by the CAP access lights. Refer to the DCSC documentation for more information about CAP.
8.	–	Enter from 1 to 21 cartridges in the CAP.
9.	–	Close the CAP door. <u>Result:</u> The cartridges will be entered into the VAX DCSC system. The volumes will be updated (or added to, depending on the response to step 5) in the MDMS volume database.

Example

```
-----
Import Volume(s)
-----
```

```
LIBRARY-ID of library [default]> Return 1
ACS ID where CAP resides [0]> Return 2
LSM ID where CAP resides [0]> Return 3
Automatically add volumes to MDMS database if not found? [YES]> Return 4
Calling MDMS to import the volumes... 5
%SLS-S-VOLENTACS, volume SQ0801 entered into ACS 6
%SLS-S-VOLUPDATED, volume SQ0801 updated in MDMS database 7
%SLS-S-VOLENTACS, volume SQ0802 entered into ACS 8
%SLS-S-VOLADDED, volume SQ0802 added to MDMS database 9
```

1 The operator specifies the default library (assigned to the JUKEBOX symbol in the file TAPE-START.COM)

2 The operator specifies the default ACS ID of 0.

3 The operator specifies the default LSM ID of 0.

4 The operator specifies that MDMS should automatically add volumes with defaults to its database if volumes entered in the CAP are not found in the database.

5 The MDMS software is called to import the volumes. The CAP “Enter” light illuminates and the CAP door unlocks. The operator places the cartridges in the CAP and closes the door.

6 Volume SQ0801 is found in the CAP and entered into the ACS.

7 SQ0801 is found and updated in the MDMS volume database.

8 Volume SQ0802 is found in the CAP and entered into the ACS.

9 SQ0802 is *not* found in the MDMS volume database. It is subsequently added with default values to the MDMS volume database.

Managing Jukebox Devices Using MDMS

13.7 Working with DCSC-Controlled Robotic Silos

13.7.6.7 ACS Management Menu: Initialize Volume Series

After a set of new volumes have been imported into the ACS, it may be necessary to initialize them. To do this, use the Initialize Volume Series option on the ACS Management Menu.

The Initialize Volume Series option displays a screen that enables you to automatically initialize existing volumes in the ACS.

13.7.6.8 13.7.6.8 Initialize Volume Series Screen Diagram

Figure 13–5 illustrates the Initialize Volume Series screen diagram.

Figure 13–5 Initialize Volume Series Screen

```
-----
Initialize Volume Series
-----
Note: Volumes must exist in VAX SLS database and must have been imported
      (or inventoried) into the ACS.

Starting volume> █
```

CXO-3346A

13.7.6.9 How To Use The Initialize Volume Series Option

Perform the steps described in Table 13–13 to use the Initialize Volume Series option.

Table 13–13 Initializing Volume Series

Step	System Prompt	Action
1.	–	Enter option 14 of the Operator Menu and press Return . <u>Result:</u> The software displays the DCSC Management Menu.
2.	–	Enter option 3 of the ACS Management Menu and press Return . <u>Result:</u> The software displays the Initialize Volume Series screen (Figure 13–5).

Managing Jukebox Devices Using MDMS 13.7 Working with DCSC-Controlled Robotic

Table 13–13 Initializing Volume Series

Step	System Prompt	Action
3.	Starting volume>	Enter the name of the starting volume in the series.
4.	Ending volume>	Enter the name of the ending volume in the series. The starting and ending volume names must have the same number of characters and the ending volume must be later in the sequence (greater than or equal to) the starting volume.
5.	Confirm if volume has already been initialized? [YES]	Enter either YES or NO . Default is YES. <u>Result:</u> The procedure will check if the volume has already been initialized and query the user before reinitializing the volume.
6.	Volume preinitialized with name of <i>name</i> . Reinitialize it? [NO]	Enter either YES or NO . Default is NO. <u>Result:</u> The user has specified YES to step 5 and a volume was found to already be initialized. Answer YES to reinitialize, NO to continue on to next volume.

Example

Note

Volumes must exist in the MDMS volume database and must have been imported or inventoried into the ACS.

Initialize Volume Series

Starting volume> sq0800 Return 1

Ending volume> SQ0802 Return 2

Confirm if volume has already been initialized? [YES] Return 3

Getting volume SQ0800 attributes... 4

Calling MDMS to load volume SQ0800... 5

%DCSC-I-MOUNTED, SQ0800 mounted on _\$2\$MUA7:, ACS Library 1

Mounting volume to see if previously initialized... 6

%MOUNT-I-MOUNTED, SQ0800 mounted on _\$2\$MUA7: (HSC003)

Volume preinitialized with name of SQ0800. Reinitialize it? [NO] Return 7

Dismounting volume...

Volume *not* initialized.

Calling MDMS to unload volume SQ0800 from drive _\$2\$MUA7:... 8

Managing Jukebox Devices Using MDMS

13.7 Working with DCSC-Controlled Robotic Silos

```
Getting volume SQ0801 attributes...

Calling MDMS to load volume SQ0801...

%DCSC-I-MOUNTED, SQ0801 mounted on _$2$MUA3:, ACS Library 1

Mounting volume to see if previously initialized...

%MOUNT-I-MOUNTED, SQ0801 mounted on _$2$MUA3: (HSC003)

Volume preinitialized with name of SQ0801. Reinitialize it? [NO] Y Return 9

Dismounting volume...

Initializing volume...

Calling MDMS to unload volume SQ0801 from drive _$2$MUA3:...

Getting volume SQ0802 attributes...

Calling MDMS to load volume SQ0802...

%DCSC-I-MOUNTED, SQ0802 mounted on _$2$MUA7:, ACS Library 1

Mounting volume to see if previously initialized...

%MOUNT-I-MOUNTED, mounted on _$2$MUA7: (HSC003) 10

Dismounting volume...

Initializing volume...

Calling MDMS to unload volume SQ0802 from drive _$2$MUA7:...
```

- 1** The operator specifies the starting volume to be SQ0800.
- 2** The operator specifies the ending volume to be SQ0802.
- 3** The operator asks to be queried to reinitialize a volume that has already been initialized.
- 4** The MDMS software is called to find if the volume exists and is in an ACS.
- 5** MDMS is called to load the volume in a drive.
- 6** The volume is mounted to determine if it has been already initialized.
- 7** The volume is found to have already been initialized. The operator is queried whether the volume should be reinitialized. The operator specifies NO, so the volume is dismounted without being reinitialized.
- 8** MDMS is called to unload the volume from the drive.
- 9** The second volume, SQ0801, has also been preinitialized. However, the operator specifies that it should be reinitialized.
- 10** The final volume, SQ0802, has not been preinitialized, so it is automatically initialized.

13.7.6.10 ACS Management Menu: Load Volume Onto Drive

Note

After a volume has been imported into the ACS, it may be loaded onto a drive. The system backup procedure will automatically load and unload volumes if a DCSC_x media type is specified in the system backup command file.

Refer to the for information on how to use the STORAGE LOAD command.

The Load Volume Onto Drive option displays a screen that enables you to automatically load an ACS volume onto an ACS drive.

13.7.6.11 Load Volume Onto Drive Screen Diagram

Figure 13–6 illustrates the Load Volume Onto Drive screen.

Figure 13–6 Load Volume Onto Drive Screen

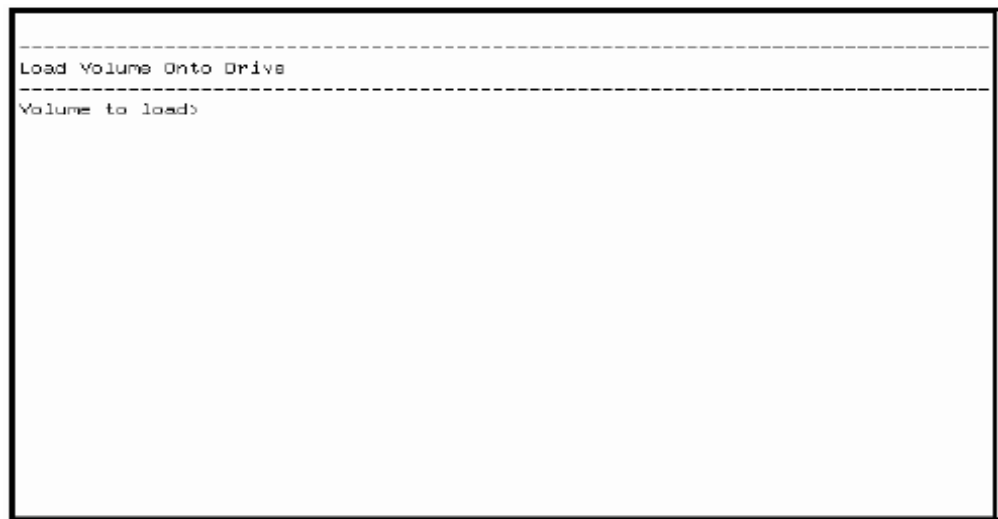

CXO-3348A

13.7.6.12 How To Use The Load Volume Onto Drive Option

Perform the steps described in Table 13–14 to use the Load Volume Onto Drive option.

Table 13–14 Loading Volumes Onto a Drive

Step	System Prompt	Action
1.	–	Enter option 14 from the Operator Menu and press Return . <u>Result:</u> The software displays the DCSC Management Menu.
2.	–	Enter option 4 from the ACS Management Menu and press Return . <u>Result:</u> The software displays the Load Volume Onto Drive screen (Figure 13–6).
3.	Volume to load>	Specify volume to load.

Managing Jukebox Devices Using MDMS

13.7 Working with DCSC-Controlled Robotic Silos

Table 13–14 Loading Volumes Onto a Drive

Step	System Prompt	Action
4.	Drive on which to load volume>	Specify which drive (physical name or a logical name) to load the volume onto.
5.	Is write access to the volume required? [NO]>	Specify if write access to the volume is required. Default is NO. <u>Result:</u> Answering NO will cause the volume to be loaded with write protection. Answering YES results in the volume loaded without write protection.

Example

```

-----
Load a Volume onto a Drive
-----

Volume to load> SQ0800 Return 1

Drive on which to load volume> $2$MUA0 Return 2

Is write access to the volume required? [NO]> YES Return 3

Calling MDMS to load SQ0800 onto $2$MUA0... 4

1 The operator specifies to load volume SQ0800.
2 Specifies the drive $2$MUA0.
3 Write access is required (no write protect).
4 The MDMS software is called to load the volume.

```

13.7.6.13 ACS Management Menu: Unload Drive

After a volume has been loaded on a drive and used, it must be unloaded. The Unload Drive option displays a screen that enables you to unload a volume from a specific drive.

13.7.6.14 Unload Drive Screen Diagram

Figure 13–7 illustrates the Unload Drive screen.

Figure 13–7 Unload Drive Screen

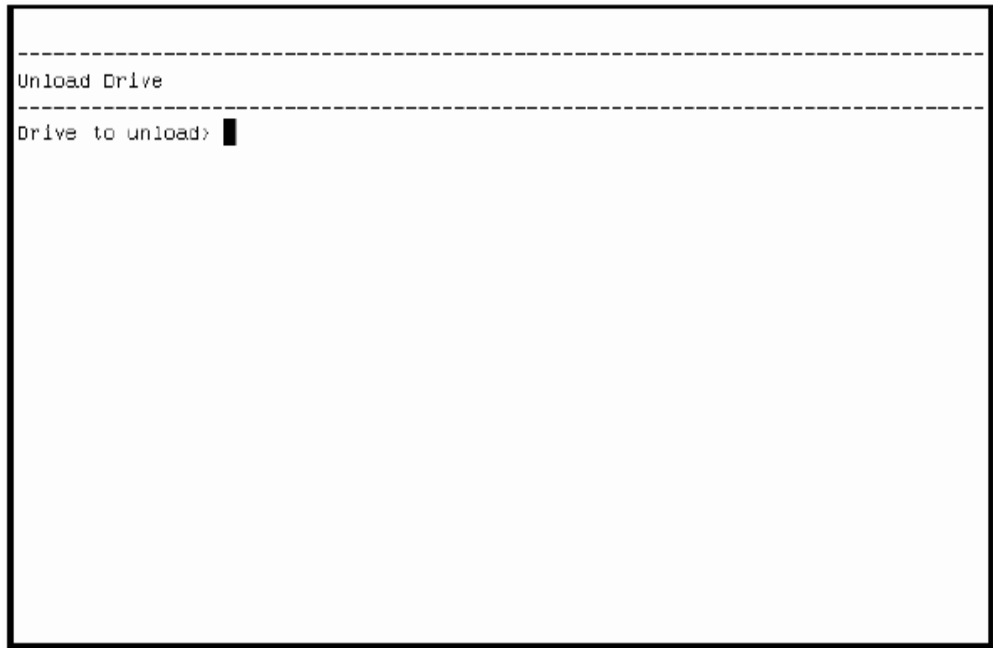

CXO-3350A

13.7.6.15 How To Use The Unload Drive Option

Perform the steps described in Table 13–15 to use the Unload Drive option.

Table 13–15 Unloading Drives

Step	System Prompt	Action
1.	–	Enter option 14 of the Operator Menu and press Return . <u>Result:</u> The software displays the DCSC Management Menu.
2.	–	Enter option 5 of the ACS Management Menu and press Return . <u>Result:</u> The software displays the Unload Drive screen (Figure 13–7).
3.	Drive to unload>	Enter the physical or logical name of the drive to unload.

Example

```
-----
Unload Drive
-----
```

```
Drive to unload> $2$MUA1 Return 1
```

```
Calling MDMS to unload $2$MUA1... 2
```

1 The operator specifies that the volume in \$2\$MUA1 should be unloaded.

Managing Jukebox Devices Using MDMS

13.7 Working with DCSC-Controlled Robotic Silos

2 MDMS software is called to do the work.

13.7.6.16 ACS Management Menu: Unload Volume

The Unload Volume option displays a screen that enables unloading a specific volume from a drive.

13.7.6.17 Unload Volume Screen Diagram

Figure 13–8 illustrates the Unload Volume(s) screen diagram.

Figure 13–8 Unload Volume(s) Screen

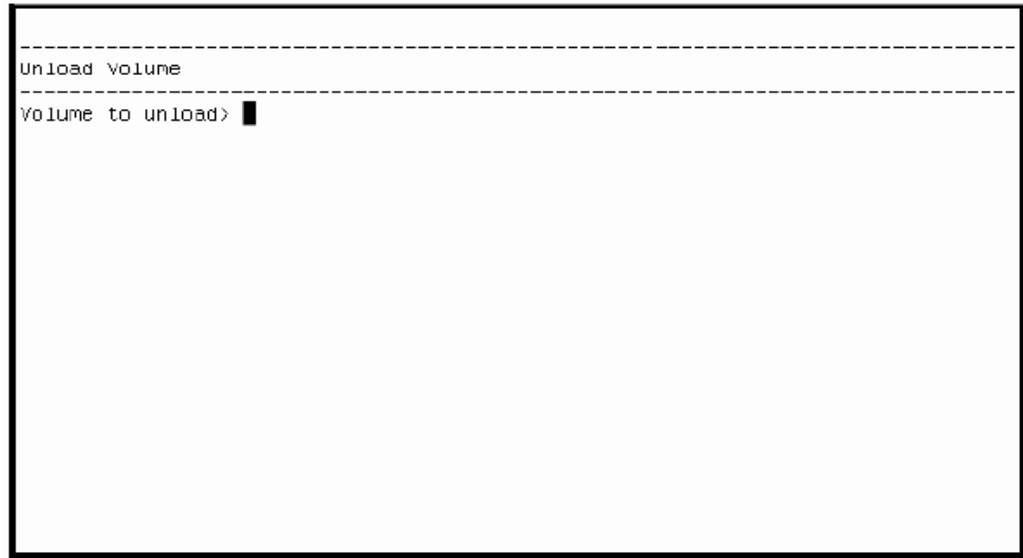

CXO-3351A

13.7.6.18 How To Use The Unload Volume Option

Perform the steps described in Table 13–16 to use the Unload Volume option.

Table 13–16 Unloading Volumes

Step	System Prompt	Action
1.	–	Enter option 14 of the Operator Menu and press Return . <u>Result:</u> The software displays the DCSC Management Menu.
2.	–	Enter option 6 from the ACS Management Menu and press Return . <u>Result:</u> The software displays the Unload Volume screen (Figure 13–8).
3.	Volume to unload>	Enter the name of the volume to unload.

Example

Unload Volume

```
-----  
Volume to unload> SQ0800 Return 1  
Calling MDMS to unload SQ0800... 2
```

- 1 The operator specifies that SQ0800 is to be unloaded.
- 2 MDMS software is called to do the work.

13.7.6.19 ACS Management Menu: Export Volume(s)

The Export Volume(s) option displays a screen that enables you to export a volume from the ACS.

13.7.6.20 Export Volume(s) Screen Diagram

Figure 13–9 illustrates the Export Volume screen.

Figure 13–9 Export Volume Screen

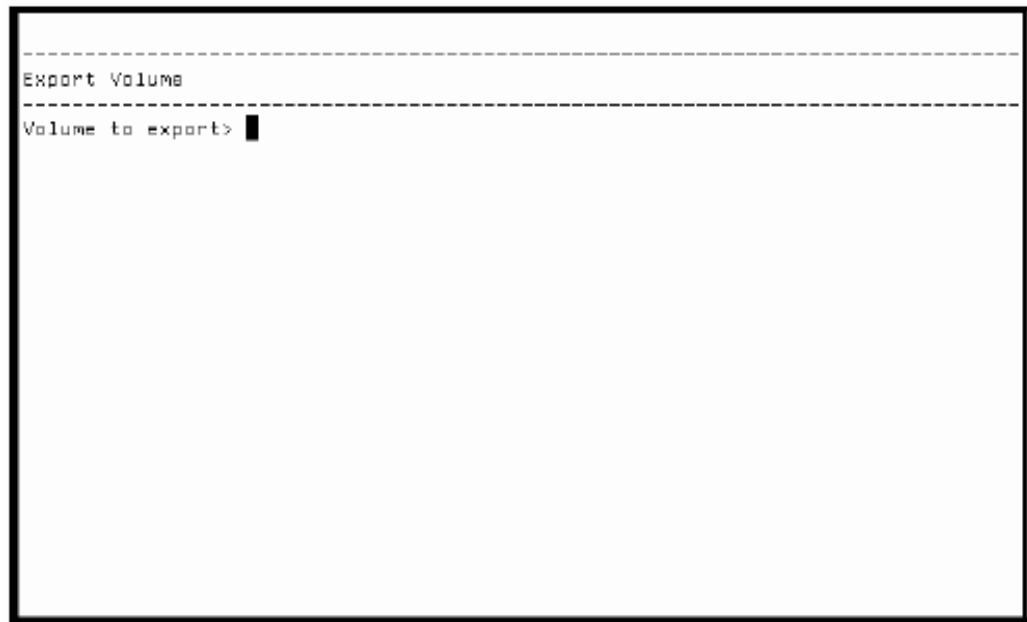

CXO-3344A

13.7.6.21 How To Use The Export Volume(s) Option

Perform the steps described in Table 13–17 to use the Export Volume(s) option.

Table 13–17 Exporting Volumes

Step	System prompt	Action
1.	–	Enter option 14 from the Operator Menu and press Return . <u>Result:</u> The software displays the ACS Management Menu.

Managing Jukebox Devices Using MDMS

13.7 Working with DCSC-Controlled Robotic Silos

Table 13–17 Exporting Volumes

Step	System prompt	Action
2.	–	Enter option 7 from the ACS Management Menu and press Return . <u>Result:</u> The software displays the Export Volume screen (Figure 13–9).
3.	Volume to export>	Specify volume to export.
4.	ACS ID where CAP resides [0]>	Enter the ID of the ACS or press Return to select the default ID of 0.
5.	LSM ID where CAP resides [0]>	Enter the ID of the LSM and press Return . Default is 0.
6.	–	Open the CAP door when instructed to do so by the CAP access lights. Refer to the DCSC documentation for more information about CAP.
7.	–	Remove the volume.
8.	–	Close the CAP door. <u>Result:</u> Exports the volume from the ACS and modifies fields in the MDMS volume record to indicate the volume is outside the ACS.

Example

Export a Volume

Volume to export> sq0800 Return **1**

ACS ID where CAP resides [0]> Return **2**

LSM ID where CAP resides [0]> Return **3**

Calling MDMS to export SQ0800... **4**

1 The operator specifies volume SQ0800 to export.

2 The operator specifies the default ACS ID of 0.

3 The operator specifies the default LSM ID of 0.

4 MDMS software is called to export the volume from the ACS.

Connecting and Managing Remote Devices

This chapter explains how to configure and manage remote devices with RDF.

14.1 The RDF Installation

When you installed the RDF software with MDMS , you placed the RDF client software on the nodes with disks you want to backup.

You placed the RDF server software on the systems to which the tape backup devices are connected.

This means that when using RDF, you serve the tape backup device to the systems with the client disks.

14.2 Configuring RDF

The two files used to configure access to remote tape or optical devices are:

1. SYSS\$MANAGER:TAPESTART.COM

This file:

- Is located on the RDF server (destination) and RDF client (source) node
- Is a text file
- Includes a media triplet of DCL symbols that define:
 - Media type (Media type names are limited to 16 characters.)
 - Density of media type, if any
 - Associated storage devices that are specified by one of the following:
 - NODE::
 - Local physical name
 - NODE:: plus RDF characteristic name
 - Local RDF characteristic name
 - Local logical name

Example:

```
$ MTYPE_1 := TF857

$ DENS_1 :=

$ DRIVES_1 := OMAHA::MIA0
```

Connecting and Managing Remote Devices

14.2 Configuring RDF

Requirement:

When specifying more than one device, separate the device names with commas.

2. TTI_RDEV:CONFIG_*nodename*.DAT

This file:

- Is located on the RDF server node with the tape or optical devices
- Is created initially during installation
- Is a text file
- Includes the definition of each device accessible by the RDF software. This definition consists of a physical device name and an RDF characteristic name.

Example:

```
Device $1$MIA0 TF857
```

Verify:

Check this file to make sure that all RDF characteristic names are unique to this node. Multiple devices can be assigned to a single RDF characteristic name. However, it is strongly recommended to set the characteristic names equal to the physical device names in order to simplify device name identification in TAPESTART.COM files on client/server nodes.

For example:

```
$ Device $1$MIA0 TF857
```

```
$ Device $1$MIA1 TF857
```

Rule:

Any time you modify the TTI_RDEV:CONFIG_*nodename*.DAT file, restart MDMS so the changes take effect.

Table 14–1 shows how to configure the file SYSS\$MANAGER\$TAPESTART.COM on both the RDF server and RDF client nodes, the file TTI_RDEV_CONFIG_*nodename*.DAT on the RDF client node, and the relationship among these files.

Figure 14–1 How RDF and MDMS Software Communicate

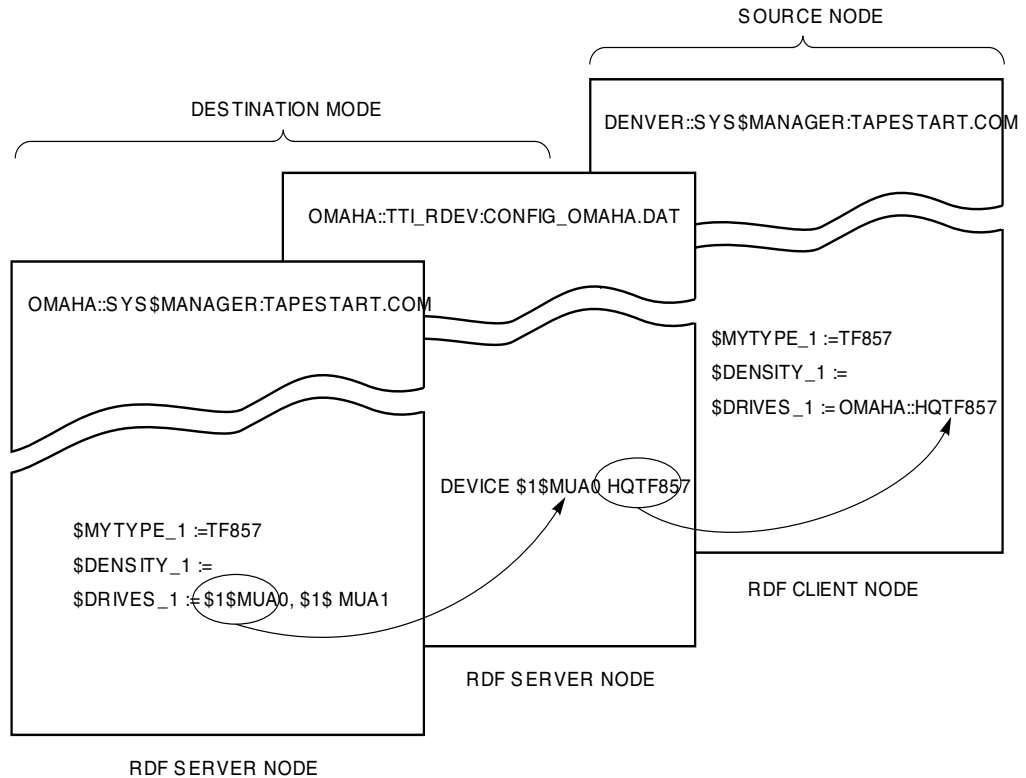

CXO-4470B-MC

In Figure 14–1, the following definitions are assigned:

RDF server node (destination node):

1. OMAHA::SYS\$MANAGER:TAPSTART.COM

In Figure 14–1, the media triplet defines:

- Media type (TF857)
- Density (none applies to this media type)
- Local drives available for the media type (\$1\$MUA0, \$1\$MUA1)

Note

In Figure 14–1, because the second device listed in the OMAHA::SYS\$MANAGER:TAP START.COM file (\$1\$MUA1) is *not listed* in the OMAHA::TTI_RDEV:CONFIG_OMAHA.DAT file, it is not available to the source node.

Restriction:

Do not assign a node name to a *local* device.

2. OMAHA::TTI_RDEV:CONFIG_ *nodename*.DAT

The device available for remote operations is defined with both:

- The physical device name (\$1\$MUA0)

Connecting and Managing Remote Devices

14.2 Configuring RDF

- The optional RDF characteristic name (HQTF857)

Verify:

Check this file to make sure that all RDF characteristic names are unique to this node. Multiple devices can be assigned to a single RDF characteristic name. However, it is highly recommended to set the characteristic name equal to the physical device name in order to simplify device naming across nodes.

RDF client (source) node:

1. DENVER::SYSS\$MANAGER:TAPESTART.COM

Define the *same* device in a media triplet:

- Media type (TF857)
- Density of the volume (none applies to this media type)
- Storage device available for the media type (OMAHA::HQTF857)

This definition contains the node name (where the device is attached) plus the RDF characteristic name.

Restriction:

Do not assign a node name to a *local* device.

Note

It is not mandatory that you specify an RDF characteristic name; you can specify explicit drive names as well.

14.2.1 Configuration Scenarios

The following system configuration scenarios are provided to show the relationship between the RDF and MDMS software configuration files. Examples showing how to modify files to implement each scenario are included. The scenarios progress in complexity.

In each of the scenarios, Omaha is the business headquarters. Node names are presented in all uppercase letters, while the physical location name is presented with an initial capital letter. This is done for clarity.

Listed respectively below each device is:

- The physical name
- The media type name associated with the device
- The RDF characteristic name

14.2.1.1 Scenario 1-Single Remote Device

Figure 14–2 describes how a backup operation invoked on node DENVER, using the media type TF857, is written to volumes loaded on remote devices on node OMAHA. Denver does not have a local device.

The backup operation is:

- Invoked in Denver
- Written to volumes loaded onto devices located in Omaha

Figure 14–2 Single Remote Device

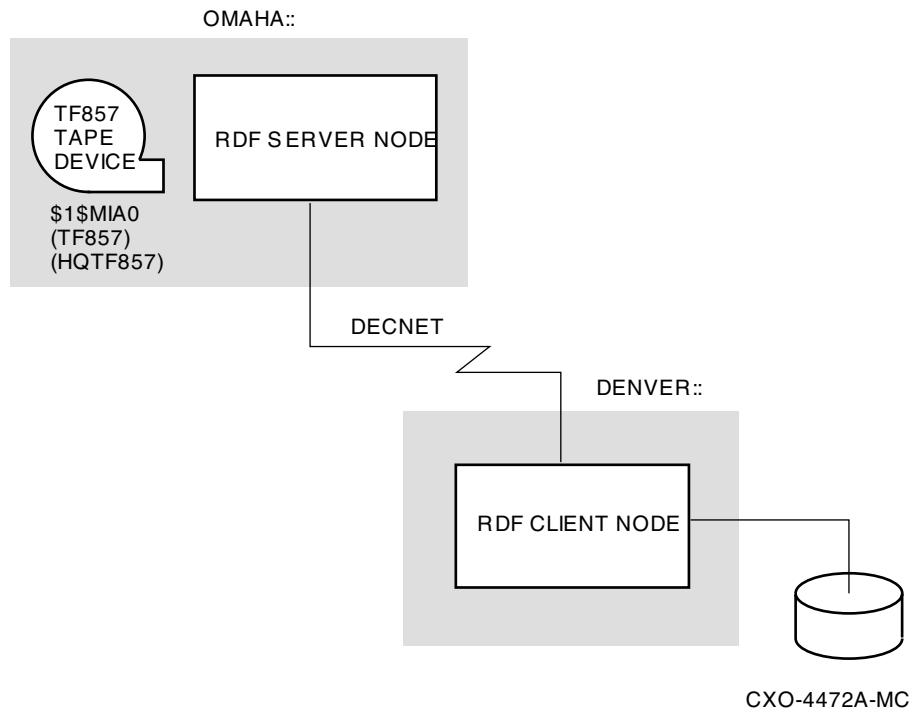

Node OMAHA::	Node DENVER::
<ul style="list-style-type: none"> • Is connected by DECnet software • Hosts the RDF server software • Has a TF857 device for local and remote backup operations (\$1\$MIA0) • Does not access any remote devices 	<ul style="list-style-type: none"> • Is connected by DECnet software • Hosts the RDF client software • Has no local tapes or devices • Accesses the TF857 device on node OMAHA::

Modifying the appropriate files:

In this scenario, modify the following files as shown:

On node OMAHA::

1. OMAHA::SYS\$MANAGER:TAPESTART.COM

```
$ MTYPE_1 := TF857

$ DENS_1 :=

$ DRIVES_1 := $1$MIA0
```

This information defines which devices are available to the MDMS software and defines the media type associated with each of those devices.

Connecting and Managing Remote Devices

14.2 Configuring RDF

Note

To enter more than one device for the media type, separate the device names with commas. For example: \$ DRIVES_1 := \$1\$MIA0,\$1\$MIA1

2. OMAHA::TTI_RDEV:CONFIG_OMAHA.DAT
DEVICE \$1\$MIA0 HQTF857

This associates the physical device name with an RDF characteristic name. In this case, a TF857 device is located in Omaha at the business headquarters.

On node DENVER:::

1. DENVER::SYSS\$MANAGER:TAPESTART.COM
\$ MYTYPE_1 := TF857

\$ DENS_1 :=

\$ DRIVES_1 := OMAHA::HQTF857

This associates the *host node name* plus the RDF characteristic name and directs backup operations using the media type TF857 to the correct device.

Note

You could use a physical device name instead of an RDF characteristic name.

2. DENVER::TTI_RDEV:CONFIG_DENVER.DAT is not needed, as DENVER:: is only an RDF client node, not an RDF server node.

14.2.1.2 Scenario 2-Local Area Network

Figure 14–3 shows that both nodes are located in a local area network in Omaha. These nodes can share the same devices. The media is kept in a common area accessible to the operations staff. There is no distinction between local and remote drive selection in this example.

Figure 14–3 Local Area Network

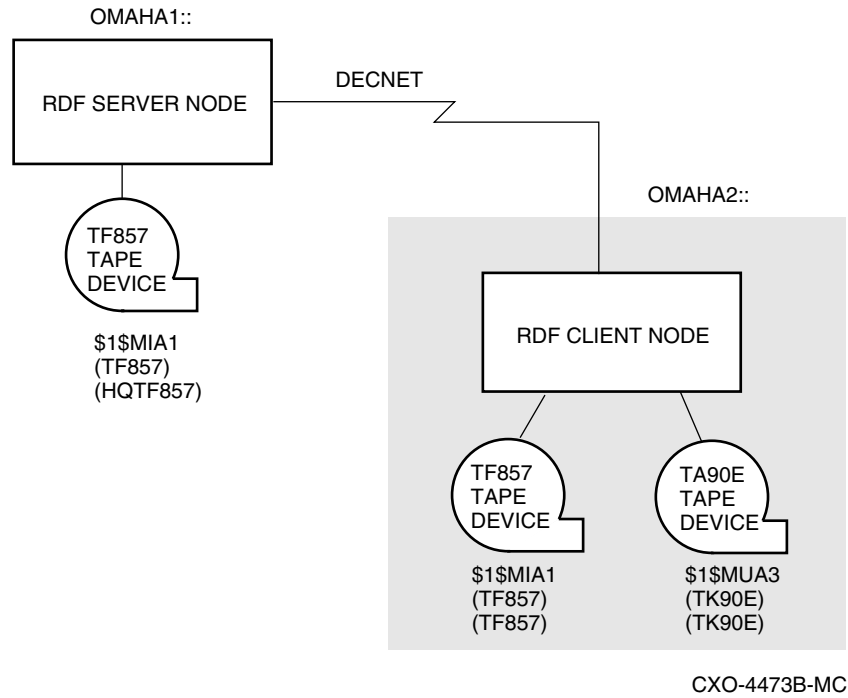

Node OMAHA1::	Node OMAHA2::
<ul style="list-style-type: none"> Is connected by DECnet software Hosts the RDF client and server software Has a TF857 device for local and remote use (\$1\$MIA1) Accesses both the TK50 and TF857 devices on node OMAHA2:: 	<ul style="list-style-type: none"> Is connected by DECnet software Hosts the RDF client and server software Has a TF857 device for local and remote use (\$1\$MIA1) Has a TK50 device for local and remote use (\$1\$MUA3) Accesses the TF857 device on node OMAHA1::

Modifying the appropriate files

In this scenario, modify the following files as shown:

On node OMAHA1::

1. OMAHA1::SYS\$MANAGER:TAPESTART.COM

```

$ MYTYPE_1 := TF857

$ DENS_1 :=

$ DRIVES_1 := $1$MIA1, OMAHA2::TF857

$

```

Connecting and Managing Remote Devices

14.2 Configuring RDF

```
$ MYTYPE_3 := TK50

$ DENS_3 :=

$ DRIVES_3 := OMAHA2::TK50
```

This information defines which devices are available to the MDMS software and defines the media type associated with each of those devices. In this case, the drives in the first media triplet (the TF857 devices on both OMAHA1:: and OMAHA2::) are interchangeable.

Note

For operations where there are multiple devices for the same media type, devices are selected using round-robin scheduling. Priority is not given to the source node.

2. OMAHA1::TTI_RDEV:CONFIG_OMAHA1.DAT

```
DEVICE $1$MIA1 HQTf857
```

This file associates the physical device names with RDF characteristic names. Remote nodes (OMAHA2::) refer to the destination node using the destination node name (OMAHA1::) followed by either the physical name (\$1\$MUA1) or the RDF characteristic name (HQTf857).

On node OMAHA2::

1. OMAHA2::SYSS\$MANAGER:TAPESTART.COM

```
$ MYTYPE_1 := TF857

$ DENS_1 :=

$ DRIVES_1 := $1$MIA1, OMAHA1::HQTf857

$

$ MYTYPE_3 := TK50

$ DENS_3 :=

$ DRIVES_3 := $1$MUA3
```

This information defines which devices are available to the MDMS software and defines the media type associated with those devices. In this case, the drives in the first media triplet (the TF857 devices on both OMAHA1:: and OMAHA2::) are interchangeable.

2. OMAHA2::TTI_RDEV:CONFIG_OMAHA2.DAT

```
DEVICE $1$MIA1 TF857

DEVICE $1$MUA3 TK50
```

This associates physical device names of the two local devices (\$1\$MIA1 and \$1\$MUA3) with RDF characteristic names (TF857 and TK50).

14.2.1.3 Scenario 3-Two-Way Remote Backup Operations

In this scenario, the *physical media* is not shared between locations. Therefore, the location of the media is reflected in a site-specific media type. MDMS software interprets the site-specific media type and directs the backup operation to the correct device.

Connecting and Managing Remote Devices 14.2 Configuring RDF

Figure 14–4 shows how local backup operations can be directed to Omaha, which has a TA90 device, and how both local and remote backup operations are available from either Miami or Omaha using the TF857 devices.

Media-type names and RDF characteristic names do not have to be different, but have been in these scenarios to illustrate that they serve two different purposes.

Figure 14–4 Two-Way Remote Backup Operation

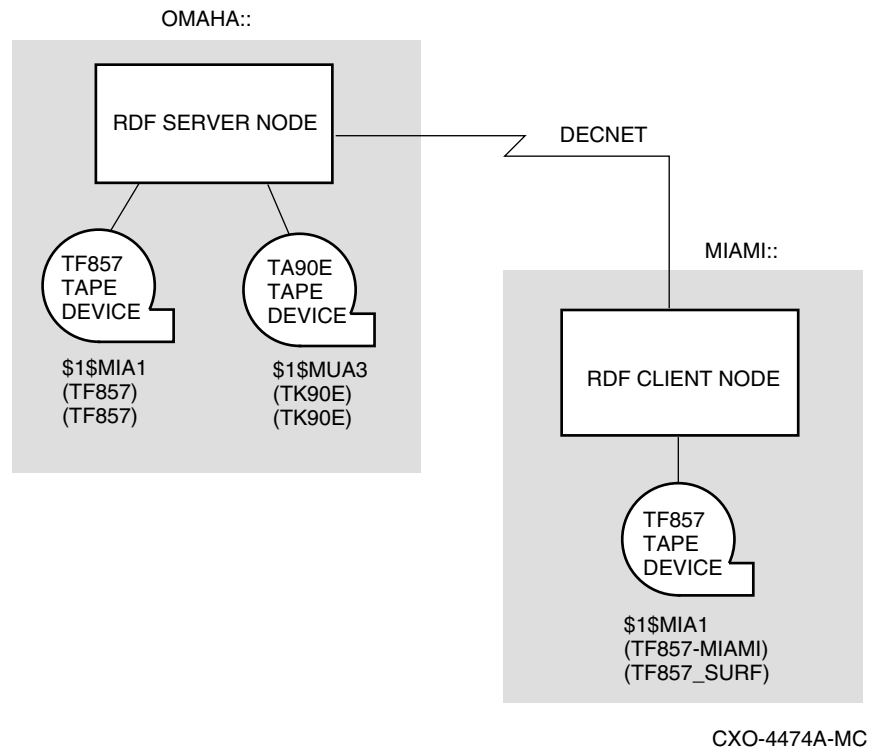

Node OMAHA::	Node MIAMI::
<ul style="list-style-type: none"> Is connected by DECnet software Hosts both the RDF server and RDF client software Has a TF857 device for local and remote backup operations (\$1\$MIA1) Has a TA90 device for local use only (\$1\$MUA3) Accesses the TF857 device on node MIAMI:: 	<ul style="list-style-type: none"> Is connected by DECnet software Hosts both the RDF server and RDF client software Has a TF857 device for local and remote backup operations (\$1\$MIA1) Accesses the TF857 device on node OMAHA::

Modifying the appropriate files

In this scenario, modify the following files as shown:

Connecting and Managing Remote Devices

14.2 Configuring RDF

On node OMAHA::

1. OMAHA::SYS\$MANAGER:TAPESTART.COM

```
$ MYTYPE_1 := TF857

$ DENS_1 :=

$ DRIVES_1 := $1$MIA1

$

$ MYTYPE_2 := TA90E

$ DENS_2 :=

$ DRIVES_2 := $1$MUA3

$

$ MYTYPE_3 := TF857_MIAAMI

$ DENS_3 :=

$ DRIVES_3 := MIAMI::$1$MIA1
```

This information defines which devices are available to the MDMS software and defines the media type associated with each of those devices. Note the media type names differ for media types located at different nodes. This is done to ensure MDMS software associates commonly located media and drives.

2. OMAHA::TTI_RDEV:CONFIG_OMAHA.DAT

```
DEVICE $1$MIA1 HQTF857

DEVICE $1$MUA3 TA90
```

This data associates the physical device names with RDF characteristic names. In this case, both the local TF857 device and a TA90 device located at the business headquarters in Omaha can be used from Miami.

On node MIAMI::

1. MIAMI::SYS\$MANAGER:TAPESTART.COM

```
$ MYTYPE_1 := TF857_MIAAMI

$ DENS_1 :=

$ DRIVES_1 := $1$MIA1

$

$ MYTYPE_2 := HQTF857

$ DENS_2 :=

$ DRIVES_2 := OMAHA::HQTF857

$

$ MYTYPE_3 := TA90E
```

```
$ DENS_3 :=  
  
$ DRIVES_3 := OMAHA::$1$MUA3
```

This information defines which devices are available to the MDMS software and defines the media type associated with those devices.

2. MIAMI::TTI_RDEV:CONFIG_MIAMI.DAT

```
DEVICE $1$MIA1 TF857_SURF
```

This associates the *host node name* of a remote device plus the RDF characteristic name and directs the backup operation to the correct location of the device. Note the RDF characteristic name differs from the media-type name for the TF857 physical device \$1\$MIA1.

14.2.1.4 Scenario 4-Multiple Remote Nodes

Figure 14–5 shows three nodes in different locations connected by DECnet software. In this scenario, some devices, but not *all*, are available for RDF use.

The three nodes are geographically separated; therefore they do not share a common set of media, but they *do* share the MDMS volume database (on OMAHA). Because there is a single MDMS volume database, *site-specific* media types *must* be used to ensure MDMS software associates commonly located media and drives.

The following example shows the use of site-specific media types for destination as well as local drives. To illustrate this, the system manager *in this scenario* has implemented the following rules:

- All media-type names consist of:
 - A standard media type (such as TK50) followed by an underscore
 - A short abbreviation of the location (such as DEN for Denver)
 - No more than 16 characters
- All RDF character names duplicate media types already associated with devices available for RDF.

Connecting and Managing Remote Devices

14.2 Configuring RDF

Figure 14-5 Backup Operation Among Multiple Remote Nodes

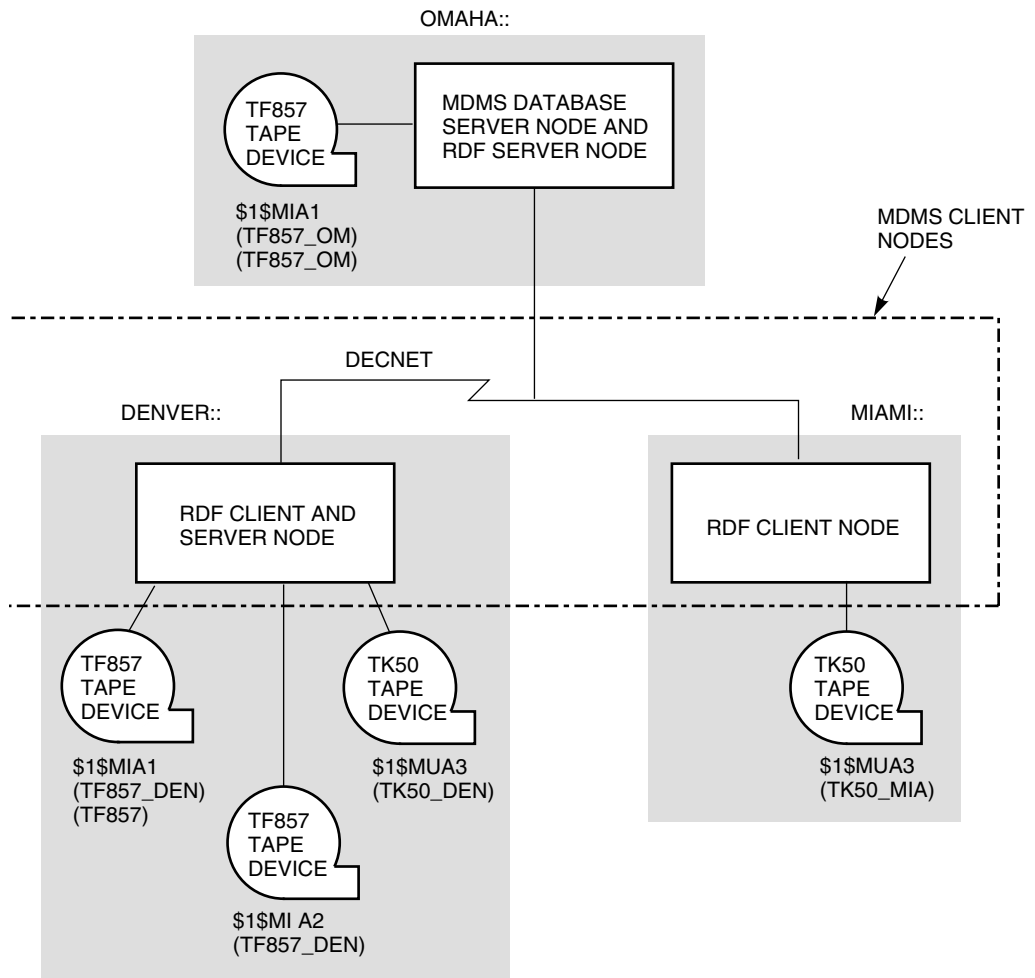

CXO-4500A-MC

Connecting and Managing Remote Devices 14.2 Configuring RDF

Node OMAHA::	Node DENVER::	Node MIAMI::
<ul style="list-style-type: none">• Is connected by DECnet software• Hosts the RDF server software• Has a TF857 device for remote use (\$1\$MUA3)• Does not access any remote devices	<ul style="list-style-type: none">• Is connected by DECnet software• Hosts both the RDF server and RDF client software• Has a TF857 device for local use only (\$1\$MIA2)• Has a TF857 device for local and remote backup operations (\$1\$MIA1)• Has a TK50 device for local use only (\$1\$MUA3)• Accesses the TF857 device on node OMAHA::	<ul style="list-style-type: none">• Is connected by DECnet software• Hosts the RDF RDF client software• Has a TK50 device for local use only (\$1\$MUA1)• Accesses TF857 devices on both node OMAHA:: and node DENVER::

Modifying the appropriate files

In this scenario, modify the following files as shown:

On node OMAHA::

1. OMAHA::SYS\$MANAGER:TAPESTART.COM

```
$ MYTYPE_1 := TF857_OM  
  
$ DENS_1 :=  
  
$ DRIVES_1 := $1$MIA1
```

This information defines which device is available to the MDMS software and defines the media type associated with the device.

2. OMAHA::TTI_RDEV:CONFIG_OMAHA.DAT

```
DEVICE $1$MIA1 TF857_OM
```

This associates the physical device name with an RDF characteristic name, enabling remote access to the device on OMAHA::.

On node DENVER::

1. DENVER::SYS\$MANAGER:TAPESTART.COM

```
$ MYTYPE_1 := TF857_DEN  
  
$ DENS_1 :=  
  
$ DRIVES_1 := $1$MIA1, $1$MIA2  
  
$  
  
$ MYTYPE_2 := TF857_OM  
  
$ DENS_2 :=
```

Connecting and Managing Remote Devices

14.3 Using RDF with MDMS

```
$ DRIVES_2 := OMAHA::TF857_OM
$
$ MYTYPE_3 := TK50_DEN
$ DENS_3 :=
$ DRIVES_3 := $1$MUA3
```

This information defines which devices are available to the MDMS software and defines the media associated with those devices.

2. DENVER::TTI_RDEV:CONFIG_DENVER.DAT

```
$ DEVICE $1$MIA1 TF857_DEN
```

This associates the *host node name* plus the RDF characteristic name and directs the backup operation to the correct device, enabling remote access to \$1\$MIA1 on the node DENVER::. Note the absence of the TK50 and the second TF857, which are not available to the RDF software.

On node MIAMI:

1. MIAMI::SYS\$MANAGER:TAPESTART.COM

```
$ MYTYPE_1 := TK50_MIA
$ DENS_1 :=
$ DRIVES_1 := $1$MUA3
$
$ MYTYPE_2 := TF857_OM
$ DENS_2 :=
$ DRIVES_2 := OMAHA::$1$MIA1
$
$ MYTYPE_3 := TF857_DEN
$ DENS_3 :=
$ DRIVES_3 := DENVER::$1$MIA1
```

This information defines which devices are available to the MDMS software and defines the media associated with those devices.

2. MIAMI::TTI_RDEV:CONFIG_MIAMI.DAT is not needed, as MIAMI:: is only an RDF client node, not an RDF server node.

14.3 Using RDF with MDMS

14.3.1 Restrictions: Using RDF with MDMS Software

Using RDF imposes the following restrictions:

- ALLOCATE-Do not use this DCL command to allocate remote devices. Use the STORAGE SELECT command to allocate remote devices.

Example:

```
$ STORAGE SELECT MYDRIVE VOL001
```

- Use the DEALLOCATE command to deallocate a remote device.

Example:

```
$ DEALLOCATE drive-name
```

Note

Before using the DEALLOCATE command, you must first execute the SLS\$TAPSYMBOL.COM file to ensure remote devices are handled correctly: \$@SYSS\$MANAGER:SLS\$TAPSYMBOL

- Labels-You can print labels only on the MDMS server database node.
- Local devices-Do not assign node names to local devices.
- RDF Client Node-Up to 16 remote devices can be allocated at one time.
- RDF Server Node-Up to 32 I/O requests initiated by RDF clients can be handled at one time.
- In a media triplet, you cannot use an RDF characteristic name for a drive that is a tape juke-box.

14.3.2 Assignments to ALLDEV and SELDEV Symbols for Remote Operations

ALLDEV and SELDEV symbol assignments control MDMS use of a listed device.

- ALLDEV assigns control of the device to MDMS software.
- SELDEV allows this device to be allocated without operator intervention.

These assignments are made in the SYSS\$MANAGER:TAPESTART.COM file on the node to which the device is physically connected.

Guidelines:

If you are performing remote MDMS operations, then the following guidelines apply:

- All devices are allocated by the node to which they are physically connected.
- Any device assigned to SELDEV must also be assigned to ALLDEV.
- RDF characteristic names can be used in ALLDEV or SELDEV.
- If you choose to use ALLDEV to control a device used for remote operations, you must include the drive names in ALLDEV in the TAPESTART.COM file on the node to which the device is physically connected.
- If a source node has any *local* devices listed in ALLDEV, *remote devices* must also be listed.

If the source node does not want any local drives in ALLDEV, the remote devices do not need to be included in ALLDEV because allocation of these devices is controlled by the node to which they are physically connected.

14.3.3 Starting Up and Shutting Down RDF Software

Starting up RDF software:

RDF software is automatically started up along with MDMS software when you enter the following command:

Connecting and Managing Remote Devices

14.3 Using RDF with MDMS

```
$ @SYS$STARTUP:SLS$STARTUP
```

Shutting down RDF software:

To shut down the RDF software, enter the following command:

```
$ @SLS$SYSTEM:SLS$SHUTDOWN RDF
```

14.3.4 The RDSHOW Procedure

Required privileges:

The following privileges are required to execute the RDSHOW procedure: NETMBX, TMP-MBX.

In addition, the following privileges are required to show information on remote devices allocated by other processes: SYSPRV, WORLD.

14.3.5 Command Overview

You can run the RDSHOW procedure any time after the MDMS software has been started. RDF software is automatically started at this time.

Use the following procedures:

- \$ @TTI_RDEV:RDSHOW CLIENT
- \$ @TTI_RDEV:RDSHOW SERVER *node_name*
- \$ @TTI_RDEV:RDSHOW DEVICES

node_name is the node name of any node on which the RDF server software is running.

14.3.6 Showing Your Allocated Remote Devices

To show remote devices that you have allocated, enter the following command from the RDF client node:

```
$ @TTI_RDEV:RDSHOW CLIENT
```

Result:

RDALLOCATED devices for pid 20200294, user DJ, on node OMAHA::

Local logical	Rmt node	Remote device
TAPE01	MIAMI::	MIAMI\$MUC0

DJ is the user name and OMAHA is the current RDF client node.

14.3.7 Showing Available Remote Devices on the Server Node

The RDSHOW SERVER procedure shows the available devices on a specific SERVER node. To execute this procedure, enter the following command from any RDF client or RDF server node:

```
$ @TTI_RDEV:RDSHOW SERVER MIAMI
```

MIAMI is the name of the server node whose devices you want shown.

Result:

Available devices on node MIAMI::

Connecting and Managing Remote Devices

14.4 Monitoring and Tuning Network Performance

Name	Status	Characteristics/Comments
MIAMI\$MSA0	in use	msa0 ...by pid 20200246, user CATHY (local)
MIAMI\$MUA0	in use	mua0 ...by pid 202001B6, user CATHY, on node OMAHA::
MIAMI\$MUB0	-free-	mub0
MIAMI\$MUC0	in use	muc0 ...by pid 2020014C, user DJ, on node OMAHA::

This RDSHOW SERVER command shows any available devices on the server node MIAMI, including any device characteristics. In addition, each allocated device shows the process PID, username, and RDF client node name.

The text (*local*) is shown if the device is locally allocated.

14.3.8 Showing All Remote Devices Allocated on the RDF Client Node

To show all allocated remote devices on an RDF client node, enter the following command from the RDF client node:

```
$ @TTI_RDEV:RDSHOW DEVICES
```

Result:

Devices RDALLOCATED on node OMAHA::

RDdevice	Rmt node	Remote device	User name	PID
RDEVA0:	MIAMI::	MIAMI\$MUC0	DJ	2020014C
RDEVB0:	MIAMI::	MIAMI\$MUA0	CATHY	202001B6

This command shows all allocated devices on the RDF client node OMAHA. Use this command to determine which devices are allocated on which nodes.

14.4 Monitoring and Tuning Network Performance

This section describes network issues that are especially important when working with remote devices.

14.4.1 DECnet Phase IV

The Network Control Program (NCP) is used to change various network parameters. RDF (and the rest of your network as a whole) benefits from changing two NCP parameters on all nodes in your network. These parameters are:

- PIPELINE QUOTA
- LINE RECEIVE BUFFERS

Pipeline quota

Connecting and Managing Remote Devices

14.4 Monitoring and Tuning Network Performance

The pipeline quota is used to send data packets at an even rate. It can be tuned for specific network configurations. For example, in an Ethernet network, the number of packet buffers represented by the pipeline quota can be calculated as approximately:

$$\text{buffers} = \text{pipeline_quota} / 1498$$

Default:

The default pipeline quota is 10000. At this value, only six packets can be sent before acknowledgment of a packet from the receiving node is required. The sending node stops after the sixth packet is sent if an acknowledgment is not received.

Recommendation:

The PIPELINE QUOTA can be increased to 45,000 allowing 30 packets to be sent before a packet is acknowledged (in an Ethernet network). However, performance improvements have not been verified for values higher than 23,000. It is important to know that increasing the value of PIPELINE QUOTA improves the performance of RDF, but may negatively impact performance of other applications running concurrently with RDF.

Line receive buffers

Similar to the pipeline quota, line receive buffers are used to receive data at a constant rate.

Default:

The default setting for the number of line receive buffers is 6.

Recommendation:

The number of line receive buffers can be increased to 30 allowing 30 packets to be received at a time. However, performance improvements have not been verified for values greater than 15 and as stated above, tuning changes may improve RDF performance while negatively impacting other applications running on the system.

14.4.2 DECnet-Plus

As stated in DECnet-Plus (DECnet/OSI V6.1) Release Notes, a pipeline quota isn't used directly. Users may influence packet transmission rates by adjusting the values for Transport's characteristics MAXIMUM TRANSPORT CONNECTIONS, MAXIMUM RECEIVE BUFFERS, and MAXIMUM WINDOW. The value for the transmit quota is determined by MAXIMUM RECEIVE BUFFERS divided by Actual TRANSPORT CONNECTIONS. This will be used for the transmit window, unless MAXIMUM WINDOW is less than this quota. In that case, MAXIMUM WINDOW will be used for the transmitter window.

The DECnet-Plus defaults (MAXIMUM TRANSPORT CONNECTIONS = 200 and MAXIMUM RECEIVE BUFFERS = 4000) produce a MAXIMUM WINDOW of 20. Decreasing MAXIMUM TRANSPORT CONNECTIONS with a corresponding increase of MAXIMUM WINDOW may improve RDF performance, but also may negatively impact other applications running on the system.

14.4.3 Changing Network Parameters

This section describes how to change the network parameters for DECnet Phase IV and DECnet-PLUS.

14.4.3.1 Changing Network Parameters for DECnet Phase IV

The pipeline quota is an NCP executor parameter. The line receive buffers setting is an NCP line parameter.

The following procedure shows how to display and change these parameters in the permanent DECnet database. These changes should be made on each node of the network.

Table 14–1 How to Change Network Parameters

Step	Action
1	Enter: <pre>\$ run sys\$system:NCP</pre> NCP>show executor characteristics <u>Result:</u> Node Permanent Characteristics as of 24-MAY-1991 10:10:58 Executor node = 20.1 (DENVER) Management version = V4.0.0 . . Pipeline quota = 10000
2	Enter: NCP>define executor pipeline quota 45000 NCP>show known lines <u>Result:</u> Known line Volatile Summary as of 24-MAY-1991 10:11:13 Line State SVA-0 on
3	Enter: NCP>show line sva-0 characteristics <u>Result:</u> Line Permanent Characteristics as of 24-MAY-1991 10:11:31 Line = SVA-0 Receive buffers = 6 <--value to change Controller = normal Protocol = Ethernet Service timer = 4000 Hardware address = 08-00-2B-0D-D0-5F Device buffer size = 1498
4	Enter: NCP>define line sva-0 receive buffers 30 NCP>exit

Requirement:

For the changed parameters to take effect, the node must be rebooted or DECnet must be shut down.

14.4.3.2 Changing Network Parameters for DECnet-Plus

The Network Control Language (NCL) is used to change DECnet-Plus network parameters. The transport parameters MAXIMUM RECEIVE BUFFERS, MAXIMUM TRANSPORT CONNECTIONS, and MAXIMUM WINDOW can be adjusted by using NCL's SET OSI TRANSPORT command. For example:

```
NCL> SET OSI TRANSPORT MAXIMUM RECEIVE BUFFERS = 4000           !default value
NCL> SET OSI TRANSPORT MAXIMUM TRANSPORT CONNECTIONS = 200    !defaultvalue
NCL> SET OSI TRANSPORT MAXIMUM WINDOWS = 20                   !default value
```

Connecting and Managing Remote Devices

14.4 Monitoring and Tuning Network Performance

To make the parameter change permanent, add the NCL command(s) to the SYSSMAN-AGER:NET\$OSI_TRANSPORT_STARTUP.NCL file. Refer to the DENET-Plus (DECnet/OSI) Network Management manual for detailed information.

14.4.4 Resource Considerations

Changing the default values of line receive buffers and the pipeline quota to the values of 30 and 45000 consumes less than 140 pages of nonpaged dynamic memory.

In addition, you may need to increase the number of large request packets (LRPs) and raise the default value of NETACP BYTLM.

Large request packets

LRPs are used by DECnet to send and receive messages. The number of LRPs is governed by the SYSGEN parameters LRPCOUNT and LRPCOUNTV.

Recommendation:

A minimum of 30 free LRPs is recommended during peak times. Show these parameters and the number of free LRPs by entering the following DCL command:

```
$ SHOW MEMORY/POOL/FULL
```

Result:

System Memory Resources on 24-JUN-1991 08:13:57.66

Large Packet (LRP) Lookaside List	Packets	Bytes
Current Total Size	36	59328
Initial Size (LRPCOUNT)	25	41200
Maximum Size (LRPCOUNTV)	200	329600
Free Space	20	32960

In the LRP lookaside list, this system has:

- Current Total Size of 36

The SYSGEN parameter LRPCOUNT (LRP Count) has been set to 25. The Current Size is not the same as the the Initial Size. This means that OpenVMS software has to allocate more LRPs. This causes system performance degradation while OpenVMS is expanding the LRP lookaside list.

The LRPCOUNT should have been raised to at least 36 so OpenVMS does not have to allocate more LRPs.

Recommendation:

Raise the LRPCOUNT parameter to a minimum of 50. Because the LRPCOUNT parameter is set to only 25, the LRPCOUNT parameter is raised on this system even if the current size was also 25.

- Free Space is 20

This is below the recommended free space amount of 30. This also indicates that LRPCOUNT should be raised. Raising LRPCOUNT to 50 (when there are currently 36 LRPs) has the effect of adding 14 LRPs. Fourteen plus the 20 free space equals over 30. This means that the recommended value of 30 free space LRPs is met after LRPCOUNT is set to 50.

Connecting and Managing Remote Devices 14.4 Monitoring and Tuning Network Perform-

- The SYSGEN parameter LRPCOUNTV (LRP count virtual) has been set to 200.

The LRPCOUNTV parameter should be at least four times LRPCOUNT. Raising LRPCOUNT may mean that LRPCOUNTV has to be raised. In this case, LRPCOUNTV does not have to be raised because 200 is exactly four times 50 (the new LRPCOUNT value).

Make changes to LRPCOUNT or LRPCOUNTV in both:

- SYSGEN (using CURRENT)
- SYS\$SYSTEM:MODPARAMS.DAT file (for when AUTOGEN is run with REBOOT)

Example: Changing LRPCOUNT to 50 in SYSGEN

```
Username:  SYSTEM

Password:  (the system password)

$ SET DEFAULT SYS$SYSTEM

$ RUN SYSGEN

SYSGEN>  USE CURRENT

SYSGEN>  SH LRPCOUNT

Parameter Name          Current   Default   Minimum   Maximum
LRPCOUNT                25       4         0        4096

SYSGEN>  SET LRPCOUNT 50

SYSGEN>  WRITE CURRENT

SYSGEN>  SH LRPCOUNT

Parameter Name          Current   Default   Minimum   Maximum
LRPCOUNT                50       4         0        4096
```

Requirement:

After making changes to SYSGEN, reboot your system so the changes take effect.

Example: Changing the LRPCOUNT for AUTOGEN

Add the following line to MODPARAMS.DAT:

```
$ MIN_LRPCOUNT = 50      ! ADDED {the date} {your initials}
```

Result:

This ensures that when AUTOGEN runs, LRPCOUNT is not set below 50.

NETACP BYTLM

The default value of NETACP is a BYTLM setting of 65,535. Including overhead, this is enough for only 25 to 30 line receive buffers. This default BYTLM may not be enough.

Recommendation:

Increase the value of NETACP BYTLM to 110,000.

How to increase NETACP BYTLM:

Before starting DECnet, define the logical NETACP\$BUFFER_LIMIT by entering:

Connecting and Managing Remote Devices

14.4 Monitoring and Tuning Network Performance

```
$ DEFINE/SYSTEM/NOLOG NETACP$BUFFER_LIMIT 110000

$ @SYS$MANAGER:STARTNET.COM
```

14.4.5 Controlling RDF's Effect on the Network

By default, RDF tries to perform I/O requests as fast as possible. In some cases, this can cause the network to slow down. Reducing the network bandwidth used by RDF allows more of the network to become available to other processes.

The RDF logical names that control this are:

```
RDEV_WRITE_GROUP_SIZE

RDEV_WRITE_GROUP_DELAY
```

Default:

The default values for these logical names is zero.

The following example shows how to define these logical names on the RDF client node:

```
$ DEFINE/SYSTEM RDEV_WRITE_GROUP_SIZE 30

$ DEFINE/SYSTEM RDEV_WRITE_GROUP_DELAY 1
```

Further reduction:

To further reduce bandwidth, the RDEV_WRITE_GROUP_DELAY logical can be increased to two (2) or three (3).

Note

Reducing the bandwidth used by RDF causes slower transfers of RDF's data across the network.

14.4.6 Surviving Network Failures

Remote Device Facility can survive network failures of up to 15 minutes long. If the network comes back within the 15 minutes allotted time, the RDCLIENT continues processing WITHOUT ANY INTERRUPTION OR DATA LOSS. When a network link drops while RDF is active, after 10 seconds, RDF creates a new network link, synchronizes I/Os between the RDCLIENT and RDSERVER, and continues processing.

The following example shows how you can test the Remote Device Facility's ability to survive a network failure. (This example assumes that you have both the RDSERVER and RDCLIENT processes running.)

```
$ @tti_rdev:rdallocate tti::mua0:
```

RDF - Remote Device Facility (Version 4.1) - RDALLOCATE Procedure

Copyright (c) 1990, 1996 Touch Technologies, Inc.

Device TTI::TTI\$MUA0 ALLOCATED, use TAPE01 to reference it

```
$ backup/rewind/log/ignore=label sys$library:*. * tape01:test
```

from a second session:

```
$ run sys$system:NCP
```

NCP> **show known links**

Connecting and Managing Remote Devices

14.5 Controlling Access to RDF Resources

Known Link Volatile Summary as of 13-MAR-1996 14:07:38

Link	Node	PID	Process	Remote link	Remote user
24593	20.4 (JR)	2040111C	MARI_11C_5	8244	CTERM
16790	20.3 (FAST)	20400C3A	-rdclient-	16791	tti_rdevSRV
24579	20.6 (CHEERS)	20400113	REMACP	8223	SAMMY
24585	20.6 (CHEERS)	20400113	REMACP	8224	ANDERSON

NCP> **disconnect link 16790**

.
. .
. . .

Backup pauses momentarily before resuming. Sensing the network disconnect, RDF creates a new -rdclient- link. Verify this by entering the following command:

NCP> **show known links**

Known Link Volatile Summary as of 13-MAR-1996 16:07:00

Link	Node	PID	Process	Remote link	Remote user
24593	20.4 (JR)	2040111C	MARI_11C_5	8244	CTERM
24579	20.6 (CHEERS)	20400113	REMACP	8223	SAMMY
24585	20.6 (CHEERS)	20400113	REMACP	8224	ANDERSON
24600	20.3 (FAST)	20400C3A	-rdclient-	24601	tti_rdevSRV

NCP> **exit**

14.5 Controlling Access to RDF Resources

The RDF Security Access feature allows storage administrators to control which remote devices are allowed to be accessed by RDF client nodes.

14.5.1 Allow Specific RDF Clients Access to All Remote Devices

You can allow *specific* RDF client nodes access to *all* remote devices.

Example:

For example, if the server node is MIAMI and access to *all* remote devices is granted only to RDF client nodes OMAHA and DENVER, then do the following:

1. Edit TTI_RDEV:CONFIG_MIAMI.DAT
2. Before the first device designation line, insert the /ALLOW qualifier

```
Edit TTI_RDEV:CONFIG_MIAMI.DAT
```

```
CLIENT/ALLOW=( OMAHA , DENVER )
```

Connecting and Managing Remote Devices

14.5 Controlling Access to RDF Resources

```
DEVICE $1$MUA0: MUA0, TK50

DEVICE MSA0: TU80, 1600bpi
```

OMAHA and DENVER (the specific RDF CLIENT nodes) are allowed access to all remote devices (MUA0, TU80) on the server node MIAMI.

Requirements:

If there is more than one RDF client node being allowed access, separate the node names by commas.

14.5.2 Allow Specific RDF Clients Access to a Specific Remote Device

You can allow *specific* RDF client nodes access to a *specific* remote device.

Example:

If the server node is MIAMI and access to MUA0 is allowed by RDF client nodes OMAHA and DENVER, then do the following:

1. Edit TTI_RDEV:CONFIG_MIAMI.DAT
2. Find the device designation line (for example, DEVICE \$1\$MUA0:)
3. At the end of the device designation line, add the /ALLOW qualifier:

```
$ Edit TTI_RDEV:CONFIG_MIAMI.DAT

DEVICE $1$MUA0: MUA0, TK50/ALLOW=(OMAHA,DENVER)

DEVICE MSA0: TU80, 1600bpi
```

OMAHA and DENVER (the specific RDF client nodes) are allowed access *only* to device MUA0. In this situation, OMAHA is not allowed to access device TU80.

14.5.3 Deny Specific RDF Clients Access to All Remote Devices

You can deny access from *specific* RDF client nodes to *all* remote devices.

For example, if the server node is MIAMI and you want to deny access to all remote devices from RDF client nodes OMAHA and DENVER, do the following:

1. Edit TTI_RDEV:CONFIG_MIAMI.DAT
2. Before the first device designation line, insert the /DENY qualifier:

```
$ Edit TTI_RDEV:CONFIG_MIAMI.DAT

CLIENT/DENY=(OMAHA,DENVER)

DEVICE $1$MUA0: MUA0, TK50

DEVICE MSA0: TU80, 16700bpi
```

OMAHA and DENVER are the specific RDF client nodes denied access to all the remote devices (MUA0, TU80) on the server node MIAMI.

14.5.4 Deny Specific RDF Clients Access to a Specific Remote Device

You can deny *specific* client nodes access to a *specific* remote device.

Example:

Connecting and Managing Remote Devices 14.6 RDserver Inactivity Timer

If the server node is MIAMI and you want deny access to MUA0 from RDF client nodes OMAHA and DENVER, do the following:

1. Edit TTI_RDEV:CONFIG_MIAMI.DAT
2. Find the device designation line (for example, DEVICE \$1\$MUA0:)
3. At the end of the device designation line, add the /DENY qualifier:

```
$ Edit TTI_RDEV:CONFIG_MIAMI.DAT

DEVICE $1$MUA0:  MUA0,  TK50/DENY=(OMAHA,DENVER)

DEVICE MSA0:    TU80,  16700bpi
```

OMAHA and DENVER RDF client nodes are denied access to device MUA0 on the server node MIAMI.

14.6 RDserver Inactivity Timer

One of the features of RDF is the **RDserver Inactivity Timer**. This feature gives system managers more control over rdallocated devices.

The purpose of the RDserver Inactivity Timer is to rddeallocate any rdallocated device if *NO* I/O activity to the rdallocated device has occurred within a predetermined length of time. When the RDserver Inactivity Timer expires, the server process drops the link to the client node and deallocates the physical device on the server node. On the client side, the client process deallocates the RDEVn0 device.

The default value for the RDserver Inactivity Timer is 3 hours.

The RDserver Inactivity Timer default value can be manually set by defining a system wide logical on the RDserver node prior to rdallocating on the rdclient node. The logical name is **RDEV_SERVER_INACTIVITY_TIMEOUT**.

To manually set the timeout value:

```
$ DEFINE/SYSTEM RDEV_SERVER_INACTIVITY_TIMEOUT seconds
```

For example, to set the RDserver Inactivity Timer to 10 hours, you would execute the following command on the RDserver node:

```
$ DEFINE/SYSTEM RDEV_SERVER_INACTIVITY_TIMEOUT 36000
```

14.7 RDF Error Messages

CLIDENY	Access from this CLIENT to the SERVER is not allowed. Check for "CLIENT/ALLOW" in the RDserver's configuration file.
CLIENTSBUSY	All 16 pseudo-devices are already in use.
DEVDENY	Client is not allowed to the Device or to the Node. This error message is dependent on the "CLIENT/ALLOW", "/ALLOW" or "CLIENT/DENY", "/DENY" qualifiers in the configuration file. Verify that the configuration file qualifier is used appropriately.
EMPTYCFG	The RDserver's configuration file has no valid devices or they are all commented out.

Connecting and Managing Remote Devices

14.7 RDF Error Messages

LINKABORT	The connection to the device was aborted. For some reason the connection was interrupted and the remote device could not be found. Check the configuration file as well as the remote device.
NOCLIENT	The RDdriver was not loaded. Most commonly the RDCLIENT_STARTUP.COM file was not executed for this node.
NOREMOTE	This is a RDF status message. The remote device could not be found. Verify the configuration file as well as the status of the remote device.
SERVERTMO	The RDserver did not respond to the request. Most commonly the RDSERVER_STARTUP.COM file was not executed on the server node. Or, the server has too many connections already to reply in time to your request.

Managing Volumes With MDMS

This chapter provides the following information:

- General volume management information, including a definition of volume terms
- How to implement the MDMS software to manage volumes

MDMS manages the physical media (volumes) on which information is stored. The MDMS software enables you to add new volumes to the MDMS volume database, control access to volumes throughout their lifecycle, remove volumes from the MDMS volume database, and report on various aspects of the MDMS volume database.

15.1 Definition of Terms

The following definitions should help you become familiar with terms associated with volume management and the related tasks.

Volume

A **volume** is a physical piece of media that contains information, such as:

- Files
- Sets of files
- Directories
- Systems

The physical media can be any of the following:

- A tape reel
- A tape cartridge
- An optical cartridge

Volume ID

The **volume ID** is a unique name assigned to a volume to distinguish it from other volumes in the database.

Naming restrictions:

- Use only six alphanumeric characters in a volume ID name to maintain ANSI control of labels.
- Name the volume ID *identical* to the volume label.

Each time the MDMS software loads a volume onto a drive, it checks the volume label to ensure that the correct volume has been loaded. If the volume label is different than the volume ID, MDMS cannot manage media effectively because it cannot validate loaded volumes.

Volume Lifecycle

Managing Volumes With MDMS

15.1 Definition of Terms

When a volume is introduced into the MDMS database, it is placed into the FREE state (described in Section 15.4). As the volume cycles through the volume database, the state of the volume is changed according to the function the volume is providing. The volume lifecycle is the amount of time that a volume is entered into the MDMS database, is cycled through its various states, and is removed from the MDMS volume database.

Volume Pool

A **volume pool** is a group of volumes that can be accessed by authorized users.

The MDMS software allows any number of volume pools.

The storage administrator determines:

- How many volume pools are created and the volume pool name
- Which user names have access to the volume pools

By doing so, a storage administrator can restrict the usage of specific volumes to specific groups of users.

Example of using volume pools:

If a department purchases 75 volumes, the storage administrator could assign three pools and place 25 volumes into each pool by project: PROJECT1, PROJECT2, and PROJECT3.

The storage administrator would then authorize individual team members (users) from each project to be able to access the appropriate volume pool.

Result:

The users would be able to allocate volumes only from their assigned pools.

Volume Set

A **volume set** is a group of two or more related volumes. Each volume in the volume set (except the last) has a “next volume,” and each volume (except the first) has a “previous volume.”

Volume Retention Period

The **volume retention period** is the number of days that a volume is allowed to remain in the TRAN state before it is released to the FREE state by the TAPEPURGE process.

The volume retention period is:

- Determined by the storage administrator
- Defined by the TRANS_AGE symbol in the file TAPESTART.COM

Slot

A **slot** is the physical storage location for a volume that is not stored in an off-site vault.

Example:

In a library room used to store volumes, there could be shelves that consist of numbered slots. Some slots could be empty, while other slots could be occupied by volumes. If a volume is stored in a particular slot, the exact volume location could be HEADQUARTERS, SLOT 23.

Jukebox

The **jukebox** is the name of the tape jukebox in which a volume currently resides.

Jukebox Slot

The **jukebox slot** is the slot in the tape jukebox where the volume is currently located.

15.2 Single-Sided and Double-Sided Media

Volumes can be either single-sided or double-sided media.

A volume that is single-sided media can be:

- A tape reel
- A tape cartridge
- An optical cartridge

A volume that is double-sided media is an optical cartridge that has two physical sides (Side A and Side B) on which information can be written. Each side of the volume:

- Is treated as a single volume
- Is assigned a separate volume ID
- Shares identical assignments for location, cleaning and purchase dates, and media type

Note

Removing the record from the database for one side of a double-sided volume automatically removes the record for the other side of the volume.

15.3 The RV02K Optical Cartridge

The RV02K cartridge is a double-sided, 12-inch optical disk placed inside a protective plastic case. The case loads directly into an RV60 optical drive.

RV02K optical cartridges are write-once, read-many (WORM) media. Once data is written to the disk area, it cannot be altered or rewritten. The data, however, can be read an unlimited number of times.

Initialization rules:

Initialize the RV02K only once before writing to it. If you initialize the RV02K any other time, all prior data is lost.

Caution

Do Not Erase
Never initialize write-once optical media with the /ERASE qualifier. Doing so will render the media useless.

Allocation recommendation:

The same user should allocate both sides of an RV02K optical cartridge. If two users own the opposite sides of the same cartridge, the user who is currently using the cartridge prevents the other from accessing the volume on the opposite side.

15.4 Volume States

To understand the concept of volume management, you must first understand the state of a volume during the volume's lifecycle in the MDMS volume database.

MDMS software manages volumes by assigning volumes to users and associating each volume with a state. The state of the volume identifies the volume's current state of use and its availability.

A volume can be in any one of the following states:

- FREE (also known as scratch)

Managing Volumes With MDMS
15.4 Volume States

- ALLOCATED
- TRAN
- DOWN

Table 15–1 shows the relationships between the volume states. The arrows represent the path that a volume can travel during its lifecycle in the MDMS volume database.

Figure 15–1 Volume State Cycling

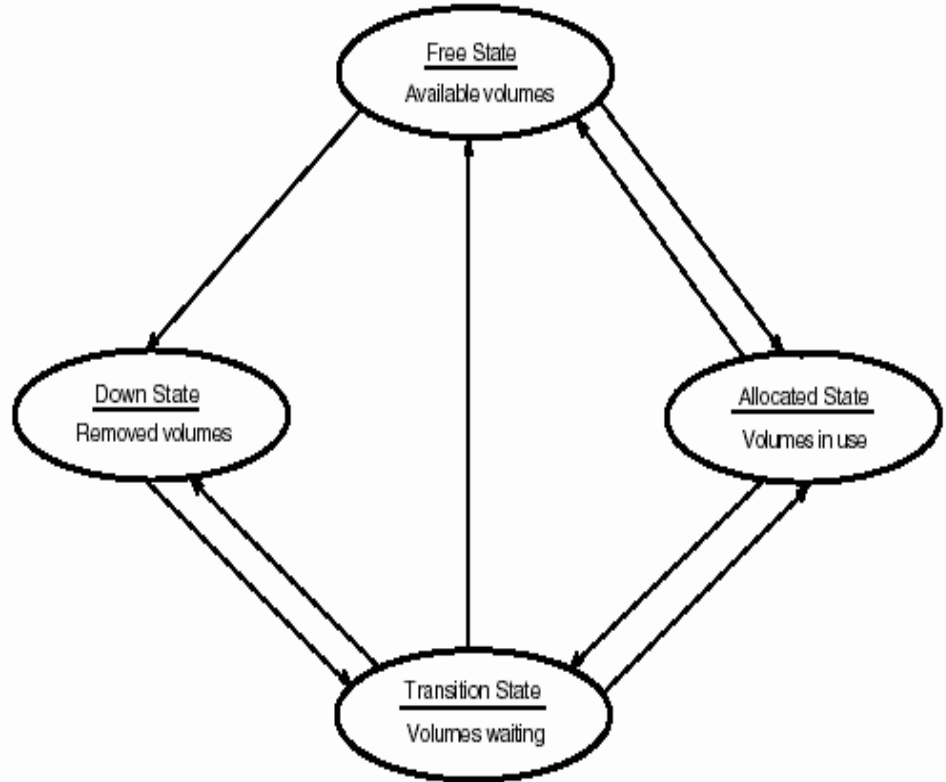

CXO-3165A

Table 15–1 shows the volume state assignments and provides a brief description of each.

Table 15–1 Volume States

A volume state of ...	Is ...	And can be assigned...	For ...
FREE	available for use	ALLOCATED	use.
		DOWN	removal from service.
ALLOCATED	in use	FREE	availability.
		TRAN	retention.
TRAN	retention from use	FREE	availability.

Table 15–1 Volume States

A volume state of . . .	Is . . .	And can be assigned...	For . . .
		ALLOCATED	use.
		DOWN	removal from service.
DOWN	taken from inventory	TRAN	retention.

Scratch Date Importance

Each time a volume is allocated, a scratch date is assigned automatically to it. A scratch date is the date that the volume is scheduled to be deallocated after being assigned to a user.

Usually, the scratch date is set one year from the date the volume is allocated, but it can be set to any period of time based on an absolute time value. Section 15.7.2.1 provides information about setting scratch dates.

15.4.1 Determining the State of a Volume

A volume state is determined by the assignment in the STATUS FLAG field. When a volume is added to the database, the STATUS FLAG field is set to the FREE state.

At each step of the lifecycle, the MDMS software automatically changes the state of a volume. As the volume passes through its lifecycle, the STATUS FLAG field assignment in the volume database record is changed from FREE to ALLOCATED to TRAN and back to FREE again.

15.4.1.1 Determining the State of Deallocated Volumes

The FRESTA symbol in the file SYSS\$MANAGER:TAPESTART.COM determines if volumes are placed in the FREE or TRAN state when they have reached their scratch date, or when an explicit STORAGE DEALLOCATE command is issued against the volume.

Table 15–2 shows the allowable assignments to the FRESTA symbol.

Table 15–2 Allowable Assignments for the FRESTA Symbol

IF you want volumes . . .	THEN assign . . .
to return immediately to the FREE state for allocation by others when it is deallocated or the volume reaches its scratch date	\$ FRESTA := FREE
to be held in the TRAN state before they become available for allocation or until the retention period is reached. ¹	\$ FRESTA := TRAN

¹ The default retention period is 14 days. However, the storage administrator determines the amount of time for the retention period.

Note

You can release a volume to the FREE state using the DCL STORAGE RELEASE command.

Managing Volumes With MDMS

15.4 Volume States

15.4.1.2 Defining the Transition Time of Volumes

The value assigned to the TRANS_AGE symbol represents the interval that the volume is allowed to stay in the TRAN state. The TRANS_AGE symbol allows volumes to stay in the TRAN state indefinitely if this symbol does not have an assigned value.

Note

MDMS uses the TRANS_AGE symbol only when the FRESTA symbol is set to TRAN.

Example:

The assignment must include days, hours, minutes, and seconds:

```
$ TRANS_AGE := 14 0:0:0
```

Where:

14 = Days

0:0:0 = Hours : Minutes : Seconds

Default:

The default value for TRANS_AGE is 14 days.

15.4.2 Changing a Volume State

Table 15–3 describes how to change the state of a volume state.

Table 15–3 How to Change the Volume State

IF you want to change the volume state to . . .	THEN enter the . . .
ALLOCATED	STORAGE ALLOCATE command. <u>Restriction:</u> Only volumes in the FREE state can be changed to the ALLOCATED state. <u>Result:</u> Assigns a volume to a user. A volume remains allocated until it is deallocated or reaches its scratch date.
FREE (and the FRESTA symbol is set to FREE)	STORAGE DEALLOCATE command. <u>Result:</u> Deassigns an allocated volume.
FREE (and the FRESTA symbol is set to TRAN)	STORAGE DEALLOCATE command, followed by the STORAGE RELEASE command. <u>Result:</u> Deassigns an allocated volume.
FREE from TRAN state	STORAGE RELEASE command. <u>Result:</u> Makes the volume available for use.

Table 15–3 How to Change the Volume State

IF you want to change the volume state to . . .	THEN enter the . . .
DOWN	STORAGE SET VOLUME/UNAVAILABLE command. <u>Restriction:</u> Only volumes in the TRAN or FREE state can be placed in the DOWN state. <u>Result:</u> Volume is no longer in service.
transition from the DOWN state	STORAGE SET VOLUME/AVAILABLE command. <u>Result:</u> Changes volume state from DOWN to TRAN or FREE, depending on the value of FRESTA in SYS\$MANAGER:TAPESTART.COM.

15.5 Adding Volumes to the MDMS Volume Database

Before MDMS can load or unload volumes, MDMS first must recognize the volumes. Information about volumes is stored in the MDMS volume database. You can add volumes to the MDMS volume database by using one of the following methods:

- The DCL STORAGE ADD VOLUME command
- The ADD VOLUME or the ADD VOLUME SERIES option from the MDMS Operator Menu/Maintenance Menu option

15.5.1 Adding Volumes from DCL

To add a volume record to the MDMS volume database, use the STORAGE ADD VOLUME command. This command allows you to add single-sided media, individual sides of double-sided media, or both sides of double-sided media.

For more information about adding double-sided media, see Section 15.5.3. For details of the syntax and qualifiers available for the STORAGE ADD VOLUME command, see the

The following example adds a single-sided volume named MYVOL1 to the MDMS volume database:

```
$ STORAGE ADD VOLUME MYVOL1
```

15.5.2 Adding Volumes from Menus

You can use the ADD VOLUME or the ADD VOLUME SERIES option from the MDMS Operator Menu/Maintenance Menu option to add individual volumes or a series of volumes to the MDMS database.

1. To access the Operator Menu, type SLSOPER at the DCL command line.
2. When the Operator Menu appears, select option 6 to access the Maintenance Menu.
3. On the Maintenance Menu, option 1 allows you to add an individual volume, while option 2 allows you to add a series of volumes.
4. Select the appropriate option and fill in the fields. To access help for the menu, press the Help key.

Recommendation:

Managing Volumes With MDMS

15.6 Initializing Volumes

Note that the menu options allow you to enter up to eight alphanumeric characters for the volume ID. We recommend, however, that you limit volume IDs to six characters that match the volume label to maintain ANSI compliance.

15.5.3 Adding Double-Sided Volumes

You can add volumes on double-sided media to the database individually or at the same time. If you choose to add the volumes separately, you must add Side A first and Side B later.

The following example adds both sides (volumes) of a double-sided medium to the MDMS volume database:

```
$ STORAGE ADD VOL/SIDE=DOUBLE MYVOLA MYVOLB
```

Note that the /SIDE=DOUBLE qualifier is required and must be placed before the volume names.

15.6 Initializing Volumes

You must initialize volumes once you have added them to the MDMS volume database. You can do this by selecting the Initialize Volumes option (3) on the Operator Menu.

15.7 Managing Volumes With MDMS

Using MDMS, you can control the availability and use of volumes in your organization. Many of the symbols that control volume states are determined to be part of the MDMS environment.

The following sections describe how to set up default values for volume management using the MDMS software. The symbols described in these sections are contained in the file SYSS\$MAN-AGER:TAPESTART.COM.

When you save data, it is important to know the following:

- The location of the volume that contains the saved data
- The physical media containing the volume and its default values
- The volume's protection

15.7.1 Assigning the Volume Default Location

Assign the default site location of the volume to the LOC symbol. This assignment appears in the LOCATION field for each volume record that uses the default assignment.

The assignment to the LOC symbol is used by the STORAGE ALLOCATE command.

Restrictions:

- The location name cannot exceed 16 characters.
- The location name cannot contain spaces, but it can contain an underscore character (_).

The default assignment for LOC is:

```
$ LOC := HEADQUARTERS
```

Note

If the value of LOC changes, any volumes allocated with the old value of LOC are not deallocated automatically when the scratch date passes.

Example: LOC Symbol Assignments

Consider the following examples when assigning the default location to the LOC symbol.

Example: Local node:

This assignment uses the local node name for the default location. (The local node name is determined by the file and is assigned to the symbol NODE.)

```
$ LOC := 'NODE'
```

Example: Node name:

This assignment shows that the default location assigned to the LOC symbol varies from node to node.

```
$ LOC := UNKNOWN

$ IF NODE .EQS. "BLD1" THEN LOC := MAIN_OFFICE

$ IF NODE .EQS. "BLD2" THEN LOC := MAIN_FACILITY

$ IF NODE .EQS. "BLD3" THEN LOC := RESEARCH_LAB
```

15.7.2 Making Volumes Available

You manage the availability of volumes by controlling the time that volumes are allowed to be allocated. The following symbols are defined in the file SYS\$MANAGER:TAPESTART.COM and are used to manage the availability of volumes:

- ALLOSCRATCH
- MAXSCRATCH

15.7.2.1 Defining the Default Volume Scratch Time for Allocation

The ALLOCSCRATCH symbol defines the default interval for determining the scratch date applied to an allocated volume.

Example:

The assignment must include days, hours, minutes, and seconds as shown:

```
$ ALLOCSCRATCH := 365 0:0:0
```

Where:

```
365 = Days
```

```
0:0:0 = Hours : Minutes : Seconds
```

Default:

The default value for ALLOCSCRATCH is 365 days.

15.7.2.2 Defining the Maximum User-Set Scratch Date

This symbol assignment specifies the maximum scratch date a user without operator privileges is allowed to apply to a volume.

Format:

The assignment must include days, hours, minutes, and seconds as shown:

```
$ MAXSCRATCH := 365 0:0:0
```

Where:

```
365 = Days
```

Managing Volumes With MDMS

15.7 Managing Volumes With MDMS

```
0:0:0 = Hours : Minutes : Seconds
```

Users can change the scratch date of volumes allocated to them if they have the following privileges enabled:

- PRIV_MODDOWN privilege
- PRIV_MAXSCR limits set to exceed the value assigned to the MAXSCRATCH symbol in the file SYSS\$MANAGER:TAPESTART.COM

Default:

The default assignment for MAXSCRATCH is a null string. Therefore, users who do not have the previously described privileges enabled cannot set scratch dates.

15.7.2.3 Notifying Users of Scratch Date

The TAPEPURGE_WORK and TAPEPURGE_MAIL symbols work together to notify MDMS users when volumes reach their scratch dates.

When volumes have reached their scratch dates, they are moved into the state defined by the FRESTA symbol. If TAPEPURGE_WORK is set to mail, a volume's owner is notified. If this notification is enabled, additional users also can receive notification by specifying them with the TAPEPURGE_MAIL symbol.

15.7.2.4 Enabling User Notification of Volume Scratch Date

The TAPEPURGE_WORK symbol controls whether the owner of a volume is notified when one of his volumes has reached its scratch date.

Assignment:

There are only two assignments that you can make to the TAPEPURGE_WORK symbol:

- MAIL (the owner is notified when his volume reaches its scratch date)
- IDLE (no mail is sent to the owner of the volume)

Default:

The default assignment for TAPEPURGE_WORK is:

```
$ TAPEPURGE_WORK := MAIL
```

15.7.2.5 Notifying Other Users When a Volume Reaches Its Scratch Date

The TAPEPURGE_MAIL symbol allows you to notify other users when a volume reaches its scratch date, and not just the owner of the volume.

Leaving this symbol blank ensures no one else is copied when mail is sent.

Default:

The default assignment notifies the SYSTEM when a volume reaches its scratch date:

```
$ TAPEPURGE_MAIL := SYSTEM
```

15.7.3 Reporting on Volume Usage

MDMS software regularly reports on all volumes allocated at any time. This feature is useful if you are in any of the following situations:

- Operate at a site that is in a commercial time-sharing environment
- Want to record the volumes in use
- Must charge back volume usage to groups in your organization

15.7.3.1 The Volume Usage Report

MDMS software automatically generates a report showing volume usage. The report is found in SLS\$ROOT:[DATA.node_name]TAPEUSE.RPT.

The system accounts for volume usage through units known as **volume-days**. A volume-day unit is one volume allocated for one day.

Example:

A user who has five volumes allocated over the course of one week (seven days) accumulates 35 volume-days.

15.7.3.2 Volume Accounting Period

TAPEUSE.RPT is a report of all volumes allocated over a user-specified span of time. This report provides the following information:

- Volumes already allocated when the time span began but freed during the time span
- Volumes already allocated when the time span and also allocated for the duration
- Volumes not allocated when the time span started but which were then allocated during the time span

Default time span:

The default time span used to create TAPEUSE.RPT is from the first day of the previous month to the first day of the current month.

15.7.3.3 Customizing Your Volume Usage Report

Refer to Table 15–4 for the volume usage reporting attributes you can customize in the SLS\$SYSTEM:TAPEUSERUN.COM file.

Note

If you need to customize the TAPEUSERUN.COM file, be sure to place your version of the file in SLS\$ROOT:[CUSTOM].

Table 15–4 Customizing Your Volume Usage Report

IF you want to customize the . . .	THEN you must change the assignment to . . .	CONSIDERING . . .
day on which TAPEUSE.RPT is created	DAYS	the possible ways you have of defining the day. <u>Default:</u> The default assignment is the first day of each month.
time and queue to process TAPEUSE.RPT	TIME	the time you want the report processed. <u>Default:</u> The default time assignment is 05:00 A.M. and the default queue is defined by the BATN symbol in the SYSS\$MANAGER:TAPESTART.COM file. This assignment also accepts any valid qualifier to the DCL SUBMIT command.

Managing Volumes With MDMS

15.7 Managing Volumes With MDMS

Table 15–4 Customizing Your Volume Usage Report

IF you want to customize the . . .	THEN you must change the assignment to . . .	CONSIDERING . . .
start of the time span	STIME	any valid DCL absolute, delta, or combination time value specifying the beginning of the time span over which you want to gather volume usage information. <u>Default:</u> The default assignment translates to the first day of the previous month.
end of the time span	ETIME	any valid DCL absolute, delta, or combination time value specifying the end of the time span over which you want to gather volume usage information. <u>Default:</u> The default assignment translates to the current day. This assumes that the current day is one month away from the beginning of the time span.
selection criteria for gathering information	BY	IF you want...
		THEN assign...
		VMS user
		BY := = USER
		group
		BY := = ACCOUNT
amount of information produced in the report	FORM	IF you want...
		THEN assign...
		detailed information by volume and user
		FORM := = FULL
		only volumedays for each user
		FORM := = BRIEF

15.7.3.4 Producing a Volume Usage Report on Demand

Sometimes it is necessary to produce a report of volume usage on demand. You can manually submit the TAPEUSE.COM file. You might want to change some of the report attributes described in Table 15–4 to suit your needs.

Requirement:

You must be logged in to an account in which you can be granted the CMKRNL privilege and read and write access to the user authorization file.

Enter the following DCL command:

```
$ SUBMIT/USER=SLS/NOPRINT/KEEP/PARAM=EXECUTE SLS$SYSTEM:TAPEUSERUN.COM
```

Recommendation:

You can create a command file for the purpose of doing demand accounting. Copy the TAPEUSERUN.COM file to SLS\$ROOT:[CUSTOM] and rename the file so it does not automatically execute.

Result:

The TAPEUSE.RPT report contains information that spans the interval starting with STIME and ending at ETIME.

15.8 Printing Labels

Many sites require paper labels to be attached to the volumes. MDMS provides the ability to print these labels.

The symbol LBL specifies the name of the printer on which to print the volume labels, or specifies a file name in which to write the printed volume labels.

Note

Labels can be printed only on the MDMS server node.

IF you want to . . .	THEN assign . . .
save the volume labels and print them at a later time	LBL := <i>file_name</i> Where <i>file_name</i> is the full file specification in which to store the label information.
print your volume labels directly to a printer	\$ LBL := <i>printer_name</i> ; Where <i>printer_name</i> is the name of the printer where you want to print the labels.

15.8.1 Label Template Files

You can modify the information that appears on the *internal* volume label by editing the file named SLSS\$SYSTEM:PRINTED_LABEL_V21.TEMPLATE. The following example shows the contents of this file:

```
VOLUME,USER  
ALLOCATION_DATE,NEXT_VOLUME  
SCRATCH_DATE,PREVIOUS_VOLUME  
NODE  
-  
Vol: !AS User: !AS  
All: !11%D Nxt: !AS  
Scr: !11%D Prv: !AS  
Node: !AS
```

You can modify this template and change the order of the fields on the volume label, or remove fields from the volume label. The top portion of the template file (above the hyphen (-)) describes the field placement in the bottom portion of the file (below the hyphen (-)). You can change the order of the fields in the bottom portion of the file, or remove a field altogether. You should also modify the top portion of the file to match the lower portion.

15.9 When to Remove Volumes from the Database

Remove volumes from the MDMS volume database when:

- You want to permanently remove them from the MDMS volume database
- They are lost
- They are damaged

Managing Volumes With MDMS

15.9 When to Remove Volumes from the Database

Volumes must be in the DOWN, FREE, or TRAN state before they can be removed from the MDMS volume database.

Authorizing Access to MDMS Media

This chapter describes how to manage and control user access to MDMS media and databases. The following tasks are related to authorizing access to the MDMS software:

- Managing the privileges that control volume maintenance
- Enabling access to the MDMS volume database
- Authorizing user access to volume pools

16.1 Managing Volume Privileges

Because the MDMS volume database contains information about the volumes where data is stored, it is necessary to restrict the casual user from seeing or modifying that information.

The volume management privileges enable users to perform certain volume management functions and are categorized in the following manner:

- MDMS privileges
- OpenVMS privileges

16.1.1 Default MDMS Privilege Assignments

The default MDMS privileges and OpenVMS privileges are defined in the file SYSS\$MAN-AGER:TAPESTART.COM:

```
$ PRIV_SEEANY := OPER
$ PRIV_MODANY := OPER
$ PRIV_MAXSCR := OPER
$ PRIV_LABEL := OPER
$ PRIV_CLEAN := OPER
$ PRIV_MODOWN := TMPMBX
```

Certain MDMS privileges are granted automatically to users who have the OpenVMS OPER privilege enabled. For PRIV_MODOWN, any user who has the OpenVMS TMPMBX privilege enabled is granted this MDMS privilege.

Example:

The following example shows how to enable PRIV_SEEANY to any user authorized with the VOLPRO OpenVMS privilege. The assignment is made in the file TAPESTART.COM.

```
$ PRIV_SEEANY := VOLPRO
```

Table 16–1 lists the MDMS privileges that enable volume management privileges, and the functions enabled by each of those privileges.

Authorizing Access to MDMS Media

16.1 Managing Volume Privileges

Table 16–1 Volume Management Privileges

MDMS Privilege	Enables
PRIV_SEEANY	<p>The user with this privilege can inquire about any volume. This privilege has an effect on the:</p> <ul style="list-style-type: none"> • MDMS Maintenance Menu Show Volume option (also requires OPER privilege) • MDMS Maintenance Menu Modify Volumes option (also requires PRIV_MODANY and OPER) • STORAGE SHOW VOLUME command • STORAGE LABEL command
PRIV_MODANY	<p>The user with this privilege can add or modify volumes and perform slot management tasks. This privilege has an effect on the:</p> <ul style="list-style-type: none"> • MDMS Maintenance Menu Modify, Add, and Remove Volume options • STORAGE SET VOLUME command (also requires PRIV_MODDOWN if not assigned OPER) • STORAGE SET VOLUME command with certain qualifiers (can also require PRIV_MODDOWN if not assigned OPER, depending upon the qualifier) • STORAGE ADD VOLUME and STORAGE REMOVE VOLUME commands • STORAGE APPEND and STORAGE SPLIT commands • STORAGE ALLOCATE/USER and STORAGE DEALLOCATE/USER commands • MDMS Maintenance Menu Slot Add and Slot Remove options (also requires OPER privilege) • MDMS Vault Management Menu Change Location option (also requires OPER privilege and PRIV_MODDOWN if not assigned OPER) • MDMS Vault Management Menu Change Date option (also requires OPER privilege) <p><u>Additional information:</u> See Section 16.1.2 for the volume database fields that a user can modify when this privilege is enabled.</p>
PRIV_MAXSCR	<p>The user with this privilege can override the MAXSCRATCH symbol defined in the file SYSS\$MANAGER:TAPESTART.COM. This privilege has an effect on the STORAGE ALLOCATE/SCRATCH_DATE command.</p>
PRIV_LABEL	<p>The user with this privilege can execute the STORAGE CREATE LABEL command.</p>

Authorizing Access to MDMS Media 16.2 Enabling Access to the MDMS Volume Database

Table 16–1 Volume Management Privileges

MDMS Privilege	Enables
PRIV_CLEAN	<p>The user with this privilege can modify certain volume attributes and free volumes in transition. This privilege has an effect on the:</p> <ul style="list-style-type: none"> • STORAGE SET VOLUME/ZERO command • MDMS Operator Menu Update Clean Data option • STORAGE RELEASE command
PRIV_MODOWN	<p>Users with this privilege can modify their own volumes using the STORAGE SET VOLUME command. This function is required with other volume management privileges for various other functions as previously described.</p> <p>Normally, all users have this MDMS privilege.</p> <p>The following rules apply to the PRIV_MODOWN privilege:</p> <ul style="list-style-type: none"> • If users have PRIV_MODOWN, they can modify any field in a volume that is allocated to their user name (except for those fields that require PRIV_MODANY). • If users do not have PRIV_MODOWN, they cannot modify any field in a volume record (even though they have allocated the volume). • PRIV_MODOWN has an effect on the STORAGE SET VOLUME command and related options in the MDMS User Menu.

16.1.2 Privileges Required to Modify Volume Database Fields

A user must have the PRIV_MODANY privilege to modify any of the following volume database record fields:

ACCOUNT	ALLOCATION DATE	ACCESS DATE
BRAND	CLEAN DATE	DRIVE STRING
FREE TIME	HOME SLOT	LENGTH
I/O ERROR COUNT	JUKEBOX STRING	LOCATION
MOUNT_COUNT	OTHERSIDE	OWNER
POOL NAME	SIDE	SLOT

16.2 Enabling Access to the MDMS Volume Database

Because the MDMS volume database is the repository for all information about MDMS volumes, you must make the database available to those MDMS client nodes need access to the volume information.

The following sections describe the tasks needed to control access to the MDMS database:

- Authorize MDMS client node access to the MDMS volume database.
- Search for a node name.
- Modify a node name entry.
- Delete a node name.

Authorizing Access to MDMS Media

16.2 Enabling Access to the MDMS Volume Database

Note

If MDMS is installed on a OpenVMS Cluster system, it is not necessary to explicitly authorize access to the database for each node in the OpenVMS Cluster system.

16.2.1 MDMS Volume Database Access Authorization Screen

The Database Access Authorization option of the MDMS Storage Administrator Menu enables MDMS client nodes access to the MDMS volume database.

The following diagram illustrates the Database Access Authorization screen.

Figure 16–1 Database Access Authorization

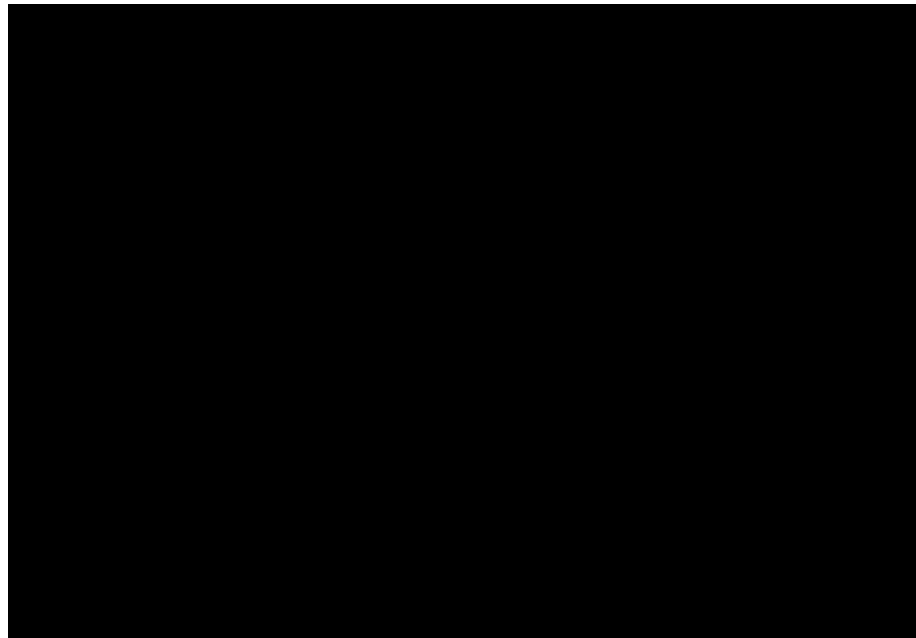

16.2.2 Database Access Authorization Screen Fields

There are two fields for data on the Database Access Authorization screen:

Field	Description
Node	Contains the MDMS client node name
Delete?	Indicates whether the entry has been selected for deletion

16.2.3 How to Authorize MDMS Client Node Access to the MDMS Volume Database

Follow the steps in Table 16–2 to allow MDMS client node access to the database.

Authorizing Access to MDMS Media 16.2 Enabling Access to the MDMS Volume Database

Table 16–2 How to Authorize Client Node Access to the MDMS Volume Database

Step	Action
1.	Access the MDMS Administrator Menu by entering the DCL command: <pre>\$ SLSMGR</pre>
2.	Select the Database Access Authorization function from the numeric keypad as follows: Enter 3 and press Return . <u>Result:</u> The software displays the Database Access Authorization screen (Section 16.2.1).
3.	Place the cursor on the line that the new node name precedes. Invoke the record insertion feature from the numeric keypad as follows: Enter 8 . <u>Result:</u> The cursor is positioned in the Node field.
4.	Enter the client node name(s) and press Tab between each entry. When you have no more node names to enter, press Return . <u>Result:</u> MDMS software prompts: <pre>Save the changed version of the file (Y/N)?</pre> If you want to save the changes, enter Y . If you do not want to save the changes, press Return .

16.2.4 How to Find a Node Name in the Database Access Authorization screen

Follow the steps in Table 16–3 to find a node name in the Database Access Authorization screen.

Table 16–3 How to Find a Node Name in the Database Access Authorization Screen

Step	Action
1.	Access the MDMS Administrator Menu by entering the following DCL command: <pre>\$ SLSMGR</pre>
2.	Select the Database Access Authorization function from the numeric keypad as follows: Enter 3 and press Return . <u>Result:</u> The software displays the Database Access Authorization screen (Section 16.2.1).
3.	Enter the search mode by pressing the Find or keypad PF9 . <u>Result:</u> A blank buffer appears on the screen.
4.	Move the cursor to the node field with the arrow keys, then type your search string.
5.	Press the Find key to find the first occurrence of the matching record.
6.	Press the Do key to find successive occurrences of matching records.
7.	

Authorizing Access to MDMS Media

16.2 Enabling Access to the MDMS Volume Database

Table 16–3 How to Find a Node Name in the Database Access Authorization Screen

IF you want to...	THEN press the...
edit the record	Select key or the keypad 7 key.
delete the record	Remove key or the keypad PF4 key.
insert a new record	Insert Here key or the keypad 8 key.

16.2.5 How to Edit a Node Name in the Database Access Authorization Screen

Follow the steps in Table 16–4 to edit a node name in the Database Access Authorization screen.

Table 16–4 How to Edit a Node Entry in the Database Access Authorization Screen

Step	Action
1.	Access the MDMS Administrator Menu by entering the DCL command: \$ SLSMGR
2.	Select the Database Access Authorization function from the numeric keypad as follows: Press keypad 3 , then press Return . <u>Result:</u> The software displays the Database Access Authorization screen (Section 16.2.1).
3.	Locate the record you want to edit by: <ul style="list-style-type: none"> Pressing the up or down arrow keys Using the search facility
4.	Press the Select key or the keypad 7 key to begin editing. <u>Result:</u> The cursor moves to the first position of the current record.
5.	<u>Replacing text:</u> To replace text in a field, type over the existing text. If the new text is shorter than the previous, use the space bar to remove the extra spaces. <u>Deleting text:</u> To delete the character to the left of the cursor, press the F10 or F12 key. To delete the word to the left of the cursor, press Ctrl J.
6.	If you want to edit another node name, repeat from Step 4; otherwise, press Return .
7.	Before you exit the screen, MDMS software prompts: Save the changed version of the file (Y/N)? If you want to save the changes, enter Y . If you do not want to save the changes, press Return .

16.2.6 How to Delete a Node Name in the Database Access Authorization Screen

Follow the steps in Table 16–5 to delete a node name entry in the Database Access Authorization screen.

Table 16–5 How to Delete a Node Name Entry in the Database Access Authorization Screen

Step	Action
1.	Access the MDMS Administrator Menu by entering the DCL command: <pre>\$ SLSMGR</pre>
2.	Select the Database Access Authorization function from the numeric keypad as follows: Enter 3 and press Return . <u>Result:</u> The software displays the Database Access Authorization screen (Section 16.2.1).
3.	Locate the record you want to edit by: <ul style="list-style-type: none">• Pressing the up or down arrow keys• Using the search facility
4.	Press the Remove key or the keypad PF4 key to select the record for deletion. <u>Result:</u> The N changes to Y in the Delete field, or the Y changes to N.
5.	If you want to delete another record, repeat from Step 3; otherwise, press Return .
6.	Before you exit the screen, MDMS software prompts the following: <pre>Save the changed version of the file (Y/N)?</pre> If you want to save the changes, enter Y . If you do not want to save the changes, press Return .

16.3 Authorizing Access to Volume Pools

Volume pools allow particular groups of MDMS users to access particular media. You can enable user access to volume pools by using the MDMS Administrator Menu/Volume Pool Authorization option.

16.3.1 MDMS Volume Pool Authorization Screen

The Volume Pool Authorization option of the MDMS Administrator Menu enables you to authorize access to volume pools by MDMS users. Figure 16–2 illustrates the Volume Pool Authorization screen.

Authorizing Access to MDMS Media

16.3 Authorizing Access to Volume Pools

Figure 16–2 Volume Pool Authorization

VOLUME POOL AUTHORIZATION				
DISPLAY	Node	User name	Pool	Delete?
	MERKUR	DWEEDLE	USER_DATA	N
	MERKUR	ZIMSA	USER_DATA	N
	VOLKS1	LESTER	PROB_CARTS	N
	VOLKS2	LESTER	DATA_CARTS	N
	[End]			

To scroll through the pool records, press UPARROW or DOWNARROW.
 To change between fields, press TAB or BACKSPACE.
 To return to the menu, press RETURN.

Display function

CXC-3163A

16.3.2 16.3.2 Volume Pool Authorization Screen Fields

There are four fields for data on the Volume Pool Authorization screen as follows:

Field	Description
Node	Contains the node name of the user
User name	Contains the OpenVMS system user name of the individual
Pool	Contains the MDMS volume pool name
Delete?	Indicates whether the entry has been selected for deletion

16.3.3 How to Authorize Access to Volume Pools

Follow the steps in Table 16–6 to allow users access to volume pools.

Table 16–6 How to Enable User Access to Volume Pools

Step	Action
1.	Access the MDMS Administrator Menu by entering the DCL command: \$ SLSMGR
2.	Select the Volume Pool Authorization function from the numeric keypad as follows: Enter 2 then press Return .
3.	Invoke the record insertion feature from the numeric keypad as follows: Enter 8 then press Return .

Authorizing Access to MDMS Media 16.3 Authorizing Access to Volume Pools

Table 16–6 How to Enable User Access to Volume Pools

4.	Enter the user’s node name in the Node field, then press Tab .								
5.	Enter the user’s name in the User name field, then press Tab .								
6.	Choose one of the following options:								
	<table border="1" style="width: 100%;"> <thead> <tr> <th style="text-align: left;">IF you want . . .</th> <th style="text-align: left;">THEN . . .</th> </tr> </thead> <tbody> <tr> <td>the user to have access only to the MDMS default volume pool</td> <td>enter nothing.</td> </tr> <tr> <td>the user to have access to a specific volume pool</td> <td>enter the volume pool name.</td> </tr> <tr> <td>the user to have access to a specific pool that also is the user’s default pool</td> <td>enter the volume pool name, and in the next to last position of the field, enter an asterisk (*).</td> </tr> </tbody> </table>	IF you want . . .	THEN . . .	the user to have access only to the MDMS default volume pool	enter nothing.	the user to have access to a specific volume pool	enter the volume pool name.	the user to have access to a specific pool that also is the user’s default pool	enter the volume pool name, and in the next to last position of the field, enter an asterisk (*).
IF you want . . .	THEN . . .								
the user to have access only to the MDMS default volume pool	enter nothing.								
the user to have access to a specific volume pool	enter the volume pool name.								
the user to have access to a specific pool that also is the user’s default pool	enter the volume pool name, and in the next to last position of the field, enter an asterisk (*).								
7.	If you want to enter another record, position the cursor on the line you want the next record to follow and repeat from Step 3. If you have no more users to enter, press Return .								

16.3.4 How to Find a User Entry in the Volume Pool Authorization Screen

Follow the steps in Table 16–7 to find a user entry in the Volume Pool Authorization screen.

Table 16–7 How to Find a User Entry in the Volume Pool Authorization Screen

Step	Action				
1.	Access the MDMS Administrator Menu by entering the DCL command: \$ SLSMGR				
2.	Select the Volume Pool Authorization function from the numeric keypad: Enter 2 , and press Return .				
3.	Enter the search mode by pressing the Find key or keypad PF8 . <u>Result:</u> A blank buffer appears on the screen.				
4.	Use the arrow keys to move the cursor to the field you want to search enter your search string. <u>Multiple field searching:</u> Enter data in more than one field to search for specific records.				
5.	Press the Find key to find the first matching record.				
6.	Press the Do key to find successive matching records.				
7.					
	<table border="1" style="width: 100%;"> <thead> <tr> <th style="text-align: left;">IF you want to . . .</th> <th style="text-align: left;">THEN . . .</th> </tr> </thead> <tbody> <tr> <td>edit the record</td> <td>press the Select key.</td> </tr> </tbody> </table>	IF you want to . . .	THEN . . .	edit the record	press the Select key.
IF you want to . . .	THEN . . .				
edit the record	press the Select key.				

Authorizing Access to MDMS Media

16.3 Authorizing Access to Volume Pools

Table 16–7 How to Find a User Entry in the Volume Pool Authorization Screen

delete the record	press the Remove key or the keypad PF4 key.
insert a new record	press the Insert Here key or the keypad 8 key.

16.3.5 How to Edit a User Entry in the Volume Pool Authorization Screen

Follow the steps in Table 16–8 to edit a user entry in the Volume Pool Authorization screen.

Table 16–8 How to Edit a User Entry in the Volume Pool Authorization Screen

Step	Action
1.	Access the MDMS Administrator Menu with the following DCL command: \$ SLSMGR
2.	Select the Volume Pool Authorization function from the numeric keypad as follows: Enter 2 and press Return .
3.	Locate the record you want by: <ul style="list-style-type: none">• Pressing the up or down arrow keys• Using the search facility The procedure in Table 16–7 describes the search steps.
4.	Press the Select key or the keypad 7 key to begin editing. <u>Result:</u> The cursor moves to the first position of the current record.
5.	Press the Tab key to move the cursor to the field you want to edit.
6.	<u>Replacing text:</u> To replace text in a field, type over the existing text. If the new text is shorter than the previous, use the space bar to remove the extra characters. <u>Deleting text:</u> To delete the character to the left of the cursor, press the Backspace or F12 key. To delete the word to the left of the cursor, enter Ctrl J.
7.	If you want to edit another field, repeat from Step 4; otherwise, press Return .
8.	Before you exit the screen, MDMS software prompts: Save the changed version of the file (Y/N)? [N] If you want to save the changes, enter Y . If you do not want to save the changes, press Return .

16.3.6 How to Delete a User Entry in the Volume Pool Authorization Screen

Follow the steps in Table 16–9 to delete a user entry in the Volume Pool Authorization screen.

Authorizing Access to MDMS Media 16.3 Authorizing Access to Volume Pools

Table 16–9 How to Delete a User Entry in the Volume Pool Authorization Screen

Step	Action
1.	Access the MDMS Administrator Menu by entering the DCL command: \$ SLSMGR
2.	Select the Volume Pool Authorization function from the numeric keypad as follows: Enter 2 and press Return .
3.	Locate the record you want by: <ul style="list-style-type: none">• Pressing the up or down arrow keys• Using the search facility The procedure in Table 16–7 describes the search steps.
4.	Press the Remove key or the keypad PF4 key to select the record for deletion. <u>Result:</u> In the Delete? field, the N changes to Y, or the Y changes to N.
5.	If you want to delete another record, repeat from Step 3; otherwise, press Return .
6.	Before you exit the screen, MDMS software prompts: Save the changed version of the file (Y/N)? [N] If you want to save the changes, enter Y . If you do not want to save the changes, press Return .

Managing Vault Storage Using MDMS

This chapter describes how to manage moving volumes to and from off-site vault storage locations and includes the following information:

- An introduction to vault management concepts
- Scheduling the dates for volumes to be transferred between on-site and off-site storage locations
- Updating the volume database with the locations of volumes as they are transferred between on-site and off-site storage locations
- Generating reports of volumes due to be transferred to the off-site storage location

17.1 Vault Management Concepts

MDMS software provides a feature for tracking volumes when they are transferred to an off-site location. If you move volumes to an off-site location and you need to restore data located on those volumes, the volume record indicates the volume is off site. If this is true, then the volume must be returned to its on-site location before you can restore the data.

It is common practice for large data centers to transfer archival volumes to off-site storage locations. This practice prevents the total loss of data in the event of a major disaster.

MDMS software provides the ability to track volumes as they move to and from an off-site storage location, known as a vault.

Volumes are considered to be on site when the location field in their Volume ID record contains the name of the default site location. This name is defined by the storage administrator with the LOC symbol in the

```
SYS$MANAGER:TAPESTART.COM file.
```

Volume ID records that contain any other value in the location field are considered to be off site. The storage administrator defines a default name for the off-site storage location with the VLT symbol in the TAPESTART.COM file.

Off-Site Vault Specification

Assign the name of your off-site storage vault to the VLT symbol.

Example:

The following example shows the off-site vault name as CASTLE:

```
$ VLT := CASTLE
```

17.2 Scheduling Vault Transfers with MDMS Software

When you save data, you have the option of specifying when the volume is scheduled to be transferred to its off-site location, and scheduling when it is to be returned to the default on-site location. These dates are recorded in the volume record.

The MDMS software makes on-site and off-site dates available through two logicals:

- SL\$ONSITE_DATE
- SL\$OFFSITE_DATE

These logicals are read daily by the file SL\$SYSTEM:SET_VAULT_DATES.COM. You can use these logicals to define the on-site and off-site date for your system backup operations.

17.2.1 Scheduling Vault Dates

You may choose one of the following methods to assign the values to SL\$ONSITE_DATE and SL\$OFFSITE_DATE:

- Explicit schedule-You can specify the dates explicitly. This is recommended when you know the volumes are going off site and returning periodically, but not on a regular weekly or daily basis.
- Daily or weekly schedule-You can specify the day of the week volumes are to be sent off site and are to be returned on site.

17.2.1.1 Explicit Schedule

The explicit schedule method requires you to edit the file SL\$SYSTEM:VAULT_DATES.DAT to specify the following dates:

- Cutoff date-The cutoff date is the last date a volume can be allocated and still have the necessary time to prepare it for transfer to the off-site location on the scheduled off-site date. The following rules apply to cutoff dates:
 - When the cutoff date is before the current date, MDMS skips the record and continues reading VAULT_DATES.DAT.
 - When the cutoff date is the same as or after the current date, <REFERENCE>(M_PROD) recognizes the specified on-site and off-site dates.
- Off-site date-The off-site date is the date the volume is schedule to transfer to the off-site storage location.
- On-site date-The on-site date is the date the volume is schedule to return to the on-site storage location.

Example_1:

An organization has contracted for the transportation of volumes between an off-site storage vault and the on-site storage location on the 15th and 30th of each month.

Volumes taken off site on the 15th of the month are scheduled to return on the 30th, and volumes taken off site on the 30th of each month are scheduled to return on the 15th of the following month. The cutoff dates are set for the 14th and 29th to make sure the volumes are ready for transfer when the transportation service arrives.

The VAULT_DATES.DAT file reads as follows:

Managing Vault Storage Using MDMS 17.2 Scheduling Vault Transfers with MDMS

CUT-OFF	OFF-SITE	ON-SITE
14-JUL-1996	15-JUL-1996	30-JUL-1996
29-JUL-1996	30-JUL-1996	15-AUG-1996
14-AUG-1996	15-AUG-1996	30-AUG-1996
29-AUG-1996	30-AUG-1996	15-SEP-1996
14-SEP-1996	15-SEP-1996	30-SEP-1996
29-SEP-1996	30-SEP-1996	15-OCT-1996

Example_2:

Another organization contracts a service to arrive daily. They know that for each backup operation, they want the volume to remain on site for one week, transfer off site for four weeks, and return on site after the four weeks are up.

The VAULT_DATES.DAT file reads as follows:

CUT-OFF	OFF-SITE	ON-SITE
31-DEC-1999	+7-	+35-

17.2.1.2 Daily or Weekly Schedule

Table 17–1 explains how to implement a daily or weekly schedule for on-site and off-site vault scheduling.

Table 17–1 How to Establish a Daily or Weekly Vault Schedule

Step	Action
1	Copy SLSS\$ROOT:[SYSTEM]SET_VAULT_DATES.COM to SLSS\$ROOT:[CUSTOM].
2	Enable processing of the second method by replacing this assignment: \$ X := 1 ! SELECT A METHOD FOR ASSIGNING OFF- SITE/ON-SITE DATES with this assignment: \$ X := 2 ! SELECT A METHOD FOR ASSIGNING OFF- SITE/ON-SITE DATES
3	For each day of the week, specify the number of days after which the volumes are scheduled to go off site and the number of days after which the volumes are scheduled to be returned. Example: The following example shows the default assignments for the file SET_VAULT_DATES.COM. The assignments show that volumes are scheduled to go off site every Friday and return on site the following Friday.

Managing Vault Storage Using MDMS

17.2 Scheduling Vault Transfers with MDMS Software

Table 17–1 How to Establish a Daily or Weekly Vault Schedule

Step	Action
	!
\$	IF DAY_OF_WEEK .NES "Monday" THEN GOTO TUESDAY
\$	ASSIGN/SYS-TEM "+4-" SL\$OFFSITE_DATE
\$	ASSIGN/SYS-TEM "+11-" SL\$ONSITE_DATE
\$	GOTO EXIT1
	\$TUESDAY
\$	IF DAY_OF_WEEK .NES "Tuesday" THEN GOTO WEDNESDAY
\$	ASSIGN/SYS-TEM "+3-" SL\$OFFSITE_DATE
\$	ASSIGN/SYS-TEM "+10-" SL\$ONSITE_DATE
\$	GOTO EXIT1
	\$WEDNESDAY
\$	IF DAY_OF_WEEK .NES "Wednesday" THEN GOTO THURSDAY
\$	ASSIGN/SYS-TEM "+2-" SL\$OFFSITE_DATE
	ASSIGN/SYS-TEM "+9-" SL\$ONSITE_DATE
\$	GOTO EXIT1
	\$THURSDAY
\$	IF DAY_OF_WEEK .NES "Thursday" THEN GOTO FRIDAY
	ASSIGN/SYS-TEM "+1-" SL\$OFFSITE_DATE
	ASSIGN/SYS-TEM "+8-" SL\$ONSITE_DATE
	\$FRIDAY
\$	IF DAY_OF_WEEK .NES "Friday" THEN GOTO NO_OFFSITE_TODAY
\$	ASSIGN/SYS-TEM "+7-" SL\$OFFSITE_DATE
\$	ASSIGN/SYS-TEM "+14-" SL\$ONSITE_DATE

17.3 Updating A Volume's On-Site or Off-Site Location

The following sections describe the operational tasks related to moving volumes to and from off-site storage locations and updating the volume's ID record. These tasks are performed by using either the Operator Menu or DCL STORAGE commands.

Note

The location of a volume is not changed automatically for the OFFSITE_DATE or ONSITE_DATE field. Because a physical movement of volumes is required and can be interrupted for a number of reasons, MDMS requires that you explicitly update the location when the move has been completed.

As volumes are transferred between on-site and off-site storage locations, the volume database needs to be updated by changing the location field in the Volume ID record. To do this, use one of the following methods:

- Enter the DCL commands RACK and VAULT. These commands are defined in the OPERSYMBOL.COM file.

The RACK command defines the volume as being on-site.

The VAULT command defines the volume as being in an off- site storage vault. See Section 17.3.1 for instructions.

- Invoke the Vault Management Menu options from the Operator Menu. These options are described in Section 17.3.2.
- Enter the DCL command STORAGE SET VOLUME/LOCATION=value. See the for information about using this command.

Recommendation:

Use the VAULT and RACK commands or the Vault Management Menu options to ensure the use of the correct location names to distinguish between on-site and off-site volumes. It is recommended that you use one of these methods instead of using the STORAGE SET/VOLUME command.

17.3.1 Changing Volume Locations Using RACK and VAULT

The DCL commands VAULT and RACK change the location field of a single Volume ID record.

IF you want	THEN Enter
Change the volume's location to on site.	\$ RACK volume-id Result: Changes the location field of the Volume ID record to the default on-site location.
Change the volume's location to off site.	\$ VAULT volume-id Result: Changes the location field of the Volume ID record to the name of the default off-site_storage_location.

17.3.2 Changing Volume Locations Using the Vault Management Menu

The Vault Management Menu option on the Operator Menu enables you to schedule volumes to be transferred between on-site and off-site storage locations, and to report on volumes that are due to transfer either on site or off site. The volume database is updated when these transfers occur.

To access the Vault Management Menu, use the following procedure:

1. Select option 12 from the Operator Menu

(Figure 2-2).

Result:

MDMS displays the Vault Management Menu

(Figure 17-1).

2. Select the appropriate option as described in Section 17.3.4.1 through Section 17.3.4.6.

Use the Vault Management Menu options when modifying:

- More than one Volume ID record at a time
- The location field to contain a name other than the default locations

17.3.3 Vault Management Menu Screen

Figure 17-1 shows an example of the Vault Management Menu screen.

Figure 17-1 Vault Management Menu

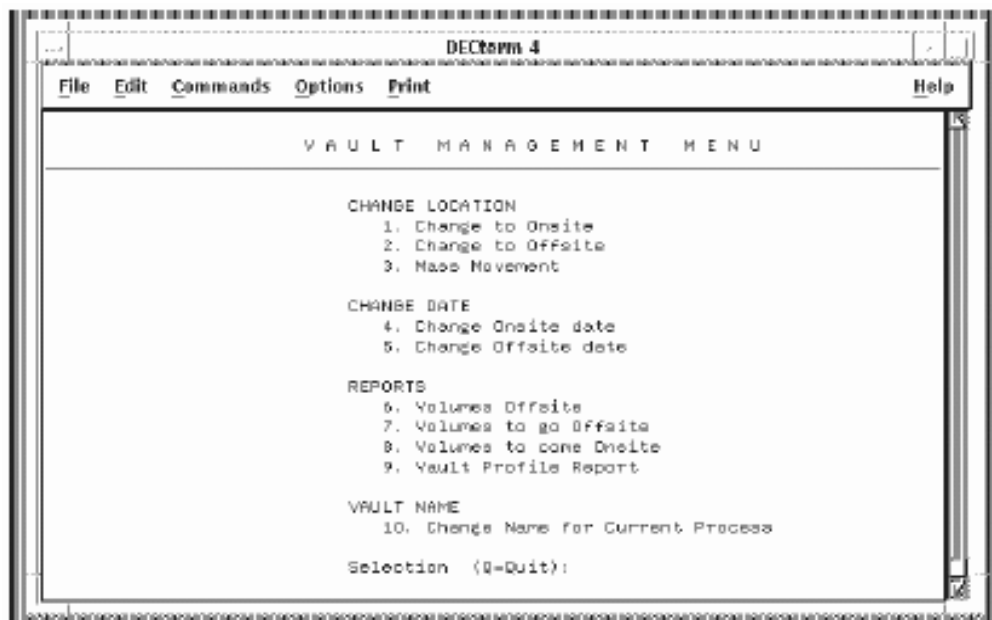

17.3.4 Vault Management Menu Options

Table 17-2 describes the options available on the Vault Management Menu.

Table 17–2 Vault Management Menu Options

Option	Description
1. Change to Onsite	Changes the location field of a Volume ID record from off-site to on-site.
2. Change to Offsite	Changes the location field of a Volume ID record from on-site to off-site.
3. Mass Movement	Changes the location of groups of volumes based upon their on-site or off-site scheduling dates.
4. Change Onsite Date	Changes the onsite date for a volume.
5. Change Offsite Date	Changes the off-site date for a volume.
6. Volumes Offsite	Generates a report of volumes currently Offsite located off-site.
7. Volumes to go Offsite	Generates a report about volumes slated to go off-site on a scheduled date.
8. Volumes to come Onsite	Generates a report about volumes due to return to the on-site location on scheduled date.
9. Vault Profile Report	Generates a report of all volumes scheduled to go off site or return on site within 10 days of a specified date.
10. Change Name for current process	Changes the current vault name for a for Current session.

To exit or abort any of the Vault Management Menu screens, do one of the following:

- Enter <Ctrl> <Z>.

Enter Q and press <Return>.

- Press <Return> (with no data).

17.3.4.1 Vault Management Menu: Change to On-site

The Change to On-site option displays a screen that allows you to change the location field of a Volume ID record from off site to on site.

To use the Change to On-site option:

1. Access the Change to On-site option (1) from the Vault Management Menu.
2. Enter the Volume ID for the volume to bring on-site from the vault and press <Return>.

17.3.4.2 Vault Management Menu: Change to Off-site

The Change to Off-site option displays a screen that allows you to change the location field of a Volume ID record from on site to off site.

To use the Change to Off-site option:

1. Access the Change to Off-site option (2) from the Vault Management Menu.
2. Enter the Volume ID for the volume to go off site and press <Return>.

Managing Vault Storage Using MDMS

17.3 Updating A Volume's On-Site or Off-Site Location

Note

To change the vault name, use the Change Name for Current Process menu option.

17.3.4.3 Vault Management Menu: Mass Movement

The Mass Movement option displays a screen that allows you to change the location field of the Volume ID records going off site or returning on site, including identifying exceptions.

- The Mass Movement screen prompts for volumes that are exceptions.
- The remaining volume(s) for the given date are modified to have their location fields reflect the new location.

To use the Mass Movement menu option:

1. Access the Mass Movement option (3) from the Vault Management Menu.
2. Identify whether the volumes are moving on-site (coming) or off-site (going).
3. Identify the location for the volumes:
 - IF you want to accept the default location [DPS], THEN press <Return>.
 - ELSE enter the new location name and press <Return>.
4. Enter the date to begin the move:
 - IF you want to accept the default date [TODAY], THEN press <Return>.
 - ELSE enter the new date and press <Return>.

Example_format:

dd-mmm-yyyy

5. Enter the date to complete the move:
 - IF you want to accept the default date [TODAY], THEN press <Return>.
 - ELSE enter the new date and press <Return>.

Example_format: dd-mmm-yyyy

6. Identify any specific volumes you do not want included in the mass movement:
 - IF you want to exclude a volume from the database change, THEN enter the Volume ID number and press <Return>.

Result:

The system prompts for the next exception.

- IF there are no (or no more) exceptions, THEN enter Ctrl/Z.
7. Press <Return> to exit the data-entry session.

Result:

All specified volumes have the location field modified.

17.3.4.4 Vault Management Menu: Change On-site Date

The Change Onsite Date option displays a screen that allows you to modify the on-site date field of the Volume ID record, one volume at a time.

To use the Change On-site Date menu option:

1. Access the Change On-site Date option (4) from the Vault Management Menu.
2. Enter the Volume ID of the volume for which you want the date changed and press <Return>.
3. Enter the date for the volume to come on site. Use an absolute or combination time format.

17.3.4.5 Vault Management Menu: Change Off-site Date

The Change Offsite Date option displays a screen that allows you to modify the off-site date field of a Volume ID record, one volume at a time.

To use the Change Offsite Date menu option:

1. Access the Change Off-site Date option (5) from the Vault Management Menu.
2. Enter the Volume ID for the volume whose off-site date needs to change and press <Return>.
3. Enter the date the volume goes off site. Use an absolute or combination time format.

17.3.4.6 Vault Management Menu: Change Name for Current Process

The Change Name for Current Process option displays a screen that allows you to change the default off-site storage location name used for the current process.

To use the Change Name for Current Process menu option:

1. Access the Change Name for Current Process option (10) from the Vault Management Menu.
2. Enter the vault name to be recorded in the database for volumes moved during this session and press <Return>.

17.4 Generating Reports

There are several reports you can generate to track volumes that are transferring to or from off-site storage locations.

You can generate the following reports from the Vault Management Menu:

- Volumes Off-site-Lists volumes currently off site.
- Volumes to go Off-site-Lists volumes due to go off site on a specified date.
- Volumes to come On-site-Lists volumes due to return on a specified date.
- Vault Profile Report-Lists volumes going to and returning from a vault within 10 days of a specified date, where the 10 days include 1 day before and 9 days after the specified date.

These reports are self-explanatory so are not explained here in detail. For information about generating reports using the STORAGE REPORT command, see the Appendix .

TAPESTART.COM Quick Reference

This appendix contains a series of tables that list the SYSS\$MANAGER:TAPESTART.COM file symbols for each major task. For additional information about symbols that relate to media and device management, see *Configuring TAPESTART.COM* in *Media and Device Management Services for OpenVMS Guide to Operations*.

C.1 TAPESTART.COM Symbols for Configuration

Appendix Table C–1 lists the symbols in the SYSS\$MANAGER:TAPESTART.COM file for configuration and descriptions of their allowable assignments.

Table C–1 TAPESTART.COM Symbols for Configuration

Symbol	Description
PRI	The name of the database node or OpenVMScluster system alias.
DB_NODES	The names of all OpenVMScluster system members running the SLS server software.
NET_REQUEST_TIMEOUT	The timeout value, in seconds, for client-server connections.
PRIMAST	The device and directory containing the SLS volume database. For more information, see Section 4.1.
HISNAM_n	The name of the <i>n</i> th SLS system history file. For more information, see Section 4.2.1.1
HISDIR_n	The directory for the <i>n</i> th SLS system history file. For more information, see Section 4.2.1.2
NODE	The node on which the SLS volume database server software runs.
BATN	The name of the batch queue on the OpenVMScluster system nodes used by SLS software.
MGRPRI	The execution priority for SLS processes.
CRLF[0,8]	ASCII carriage return value.
CRLF[8,8]	ASCII line feed value.
ESC[0,8]	ASCII escape value.
ESC_LOAD_BOLD	Escape sequence that displays OPCOM LOAD request messages in bold format.

TAPESTART.COM Quick Reference

C.1 TAPESTART.COM Symbols for Configuration

Table C–1 TAPESTART.COM Symbols for Configuration

Symbol	Description
ESC_LOAD_BLNK	Escape sequence that displays OPCOM LOAD requests in a blinking format.
ESC_LOAD_NORM	Escape sequence that displays OPCOM LOAD requests in a normal format.
ESC_ALLOC_BOLD	Escape sequence that displays OPCOM ALLOCATE requests in a bold format.
ESC_ALLOC_NORM	Escape sequence that displays OPCOM ALLOCATE requests in a normal format.
ESC_MOUNT_OPER	String to be used for OPCOM MOUNT request messages.
ESC_MOUNT_BOLD	Escape sequence that displays OPCOM MOUNT requests in a bold format.
ESC_MOUNT_NORM	Escape sequence that displays OPCOM MOUNT requests in a normal format.
TOPERS	The list of operator classes to receive load requests.
QUICKLOAD	<p>Enables SLS to automatically send a reply when a STORAGE LOAD command is issued.</p> <ul style="list-style-type: none"> • Enable SLS to send a reply <code>\$ QUICKLOAD == 1</code> • Disable SLS to send a reply <code>\$ QUICKLOAD == 0</code>
VERBOSE	<p>Enables or disables broadcast. Notifies operators of system backup operation start and completion.</p> <ul style="list-style-type: none"> • Enable <code>\$ VERBOSE == 1</code> • Disable <code>\$ VERBOSE == 0</code>
ALLDEV	All devices under control of SLS software.
SELDEV	All devices that can be selected by SLS software without operator intervention.
ALLTIM	The interval of time between scans for available drives.
JUKEBOX	The name of the default optical jukebox.
JUKEBOX_n_NAME	The name of the <i>n</i> th jukebox.
JUKEBOX_n_LOWER	The lowest numbered slot in the <i>n</i> th jukebox that is for use by SLS software.
JUKEBOX_n_UPPER	The highest numbered slot in the <i>n</i> th jukebox that is for use by SLS software.
CLEANUP_Q	The batch queue and time of day for the cleanup process to run.

TAPESTART.COM Quick Reference

C.2 TAPESTART.COM Symbols for Standby Archiving

Table C–1 TAPESTART.COM Symbols for Configuration

Symbol	Description
SYSCLN_RUN	The days on which the SLS system history file cleanup process will run and the duration of each run. For more information, see Section 4.3.
BAKFMT	<p>The default save format.</p> <ul style="list-style-type: none"> • BACKUP <code>\$ BAKFMT := BACKUP</code> • ASCII for a file copy <code>\$ BAKFMT := ASCII</code> • EBCDIC for EBCDIC formatted files <code>\$ BAKFMT := EBCDIC</code> <p>For more information, see Section 6.1.3.1.</p>
BAKOPT	The default options for the Operator Save Screen. For more information, see Section 6.1.3.3.
BACKUP_DEFAULT_REEL	The default allocation method for user backup operations. For more information, see Section 6.1.3.5.
BAKQUE	The default queue for system backup operations. For more information, see Section 6.1.3.7.
BACKUP_FINISH	<p>Notifies when system backup operations finish.</p> <ul style="list-style-type: none"> • Mail notification <code>\$ BACKUP_FINISH := MAIL</code> • Reply notification <code>\$ BACKUP_FINISH := REPLY</code> <p>For more information, see Section 6.1.3.8.</p>

C.2 TAPESTART.COM Symbols for Standby Archiving

Table C–2 lists the symbols in the SYSS\$MANAGER:TAPESTART.COM file for standby archiving and descriptions of their allowable assignments.

Table C–2 TAPESTART.COM Symbols for Standby Archiving

SBARLOG	The location for the standby archiving log. For more information, see Section 9.2.5.1.
SBARINT	The interval for SLS software to check for standby archiving requests. For more information, see Section 9.2.5.2.
SBACLAS	The default standby archiving class. For more information, see Section 9.2.5.3.

TAPESTART.COM Quick Reference

C.3 TAPESTART.COM Symbols for Restore Operations

Table C–3 TAPESTART.COM Symbols for Standby Archiving

Symbol	Description
SBARLOG	The location for the standby archiving log. For more information, see Section 9.2.5.1.
SBARINT	The interval for SLS software to check for standby archiving requests. For more information, see Section 9.2.5.2.
SBACLAS	The default standby archiving class. For more information, see Section 9.2.5.3.

C.3 TAPESTART.COM Symbols for Restore Operations

Table C–3 lists the symbols in the SYSS\$MANAGER:TAPESTART.COM file for restore operations and descriptions of their allowable assignments.

Table C–4 TAPESTART.COM Symbols for Restore Operations

Symbol	Description
RESQUE	Queue for restore operations. For more information, see Section 7.1.1.
RESOPT	Default options for the Operator Restore Screen. For more information, see Section 7.1.2.
RESTORE_FINISH	Notification when restore operations finish. <ul style="list-style-type: none">• Mail notification <code>\$ RESTORE_FINISH := MAIL</code>• Reply notification <code>\$ RESTORE_FINISH := REPLY</code> For more information, see Section 7.1.3.

Glossary

This glossary contains definitions of commonly used terms in the Storage Library System for OpenVMS Version 2.9H documents.

absolute time

A data entry format for specifying the date or time of day. The format for absolute time is [dd-mmm-yyyy[:]][hh:mm:ss.cc]. You can specify a specific date and time, or use the keywords TODAY, TOMORROW, or YESTERDAY.

Compare with combination time.

access port

The port on a DCSC-controlled silo where cartridges can be inserted into the silo.

active server process

The SMF server process that is currently active. The active server process responds to requests issued from an SMF client process.

allocate

To reserve something for private use. In SLS software, a user is able to allocate media sets for backup operations.

allocated

One of four volume states. Volumes that are reserved for exclusive use by a user are placed in the allocated state. Allocated volumes are available only to the user name assigned to that volume.

ANSI

The abbreviation for the American National Standards Institute, an organization that publishes computer industry standards.

ANSI-labeled

An ANSI-labeled volume is a magnetic tape that complies with the ANSI standards for label, data, and record formats. The format of VMS ANSI-labeled magnetic tape volumes is based on Level 3 of the ANSI standard for magnetic tape labels and file structure.

archive

A repository of data that consists of :

- Archive Media that contains zero or more archive files.

- One or more archive catalogs that record information about archive files and archive objects stored on archive media.
- A set of archive services which are used to define configuration and site policy. They are also used to move data between the archive client and the archive media.

archive class

Used to define the logical characteristics of the output of an archive request. Specify the archive class when initiating an archive request.

archive client

The type of backup engine that is allowed to use SLS. For example, archive clients of SLS are VMS BACKUP and Oracle RMU BACKUP.

See also backup engine.

archive media

Any media on which archived files are stored.

archive object

An object stored in the archive and consists of the following:

- An entry in the archive catalog
- A set of client metadata
- The data associated with the object

archive request

A request to move data into the archive. This can be done by using either the DCL command interface or the SLS window interface.

archiving

Saving data to the appropriate media for the purpose of long-term storage.

ASCII

The abbreviation for the American Standard Code for Information Interchange. This code is a set of 8-bit binary numbers representing the alphabet, punctuation, numerals, and other special symbols used in text representation and communications protocols.

back up

To make duplicate copies of one or more files, usually onto different media than the original media. This provides the availability to restore the original data if it is lost or corrupted.

BACKUP

The DCL command for the VMS Backup utility. *See* VMS Backup utility.

backup engine

The backup engine is used to move data to and from the archive. Examples: VMS BACKUP and Oracle RMU BACKUP.

See also archive client

BACKUP format

Standard VMS BACKUP format. The BACKUP format is the recording format used by the VMS Backup utility to back up data to save sets.

backup process

The duplication of files. The SLS software uses the VMS Backup utility to perform backup operations on BACKUP formatted volumes.

Backup operations can copy standard VMS files on a Files-11 structured system disk or create BACKUP save sets to magnetic tape, a system disk, or an optical cartridge.

Backup operations can also restore save sets to standard the VMS file format, restoring them from the save set volume to a Files-11 structured disk.

See also save process

batch process

A process where the operating system executes commands that are placed in a file. The file is submitted to the system for execution.

bind

The act of logically binding volumes into a magazine. This makes the volumes a logical unit that cannot be separated unless an UNBIND operation is done on the volumes.

blocking factor

The number of records in a physical tape block. The length of a physical block written to magnetic tape is determined by multiplying the record length by the blocking factor. For example, if a record length of 132 and a blocking factor of 20 are specified, the length of each physical block written to tape will be 2640 bytes (or characters).

The blocking factor is only used when SLS software is writing an EBCDIC tape.

BYPASS privilege

Allows users to read, write, execute and delete all files on the system. Refer to the *Guide to VMS System Security* for more information.

cartridge

An enclosure that contains a recordable medium.

client file system

The place where data resides when applications are using the data. The client file system is a unique, on-disk structure that contains customer data and its associated metadata. The client file system normally consists of one or more disk drives connected to a node, but it may also be a specialized subset of a disk, such as an Oracle Rdb database.

client metadata

The information that the client file system associates with an object to manage the object within the client file system.

Examples are: ODS-2 file headers and UNIX i-nodes.

client node

The nodes that do not have direct access to the SLS database. These nodes send database requests to the server node.

combination time

A data entry format for specifying date and time. Combination time consists of an absolute time value plus or minus a delta time value.

Examples:

"TODAY+7-" indicates current date plus seven days

"TODAY+7" indicates current date plus seven hours

"TOMORROW-1" indicates current date at 23:00 hours

command

An instruction, generally an English word, entered by the user at a terminal. The command requests the software to perform a predefined function.

compound object sets

A list of business units, named object sets, and simple object sets. Allows you to group related data for treatment and a single entity.

CRC

The acronym for cyclic redundancy check. It is a verification process used to ensure data is correct.

data movement request

Either an archive or restore request initiated through either the DCL command interface or the SLS window interface.

deallocate

To relinquish ownership of a device or media set.

- When a drive is deallocated, it is then available for allocation by other processes.
- When a media set is deallocated, it is either immediately available for allocation by other users or moved into a transition state.

default

A value or operation automatically included in a command or field unless the user specifies differently. In all SLS documents, default settings are indicated within enclosed brackets “[]”.

density

The number of bits per inch (bpi) on magnetic tape. Typical values are 6250 bpi and 1600 bpi.

double-sided media

Media that has two sides on which data can be written. For example: An optical cartridge contains two recording surfaces, one on each side of the optical cartridge.

down

A volume state. Volumes that are either damaged, lost, or temporarily removed for cleaning are placed in the down state.

EBCDIC

The acronym for Extended Binary Coded Decimal Interchange Code. EBCDIC is an unlabeled IBM recording format. Volumes in EBCDIC format do not have records in the SLS volume database.

execution environment

The environment in which a data movement request is executed. It defines the attributes of the system, network, and backup engine to be used to move data.

Specify the name of the execution environment when creating an archive or restore request.

foreign

In the context of SLS software and operations, the word foreign indicates that the volume does not exist in the SLS volume database.

format

See recording format.

free

A volume state. Volumes that are available for allocation by users are in the free state.

I/O station

A jukebox component that enables an operator to manually insert and retrieve cartridges. The I/O station consists of an I/O station door on the outside of the jukebox, and an I/O station slot on the inside. *See also* I/O station door and I/O station slot.

I/O station door

An actual door on the outside of the jukebox that can be opened and closed.

Behind the I/O station door is the I/O station slot.

I/O station slot

An I/O slot that holds a cartridge when it is entering or leaving the jukebox.

in port

The physical opening in a jukebox where cartridges can be imported into the jukebox.

interactive process

A process where the user and the operating system communicate by displayed messages and replies. In an interactive process, the operating system acknowledges and acts upon commands that are entered at a terminal by the user.

interface

A shared physical or logical boundary between computing system components.

Interfaces are used for sending and/or accepting information and control between programs, machines, and people.

inventory

The act of automatically updating the MDMS database. MDMS can mount each volume located in a magazine and update the MDMS volume database through this process.

label

Label has two meanings:

1. Information recorded at a fixed location on the media that identifies the volume to software.
2. The physical printed label attached to the outside of a tape or cartridge to identify it.

labeled

A recording format which includes a volume label.

LEBCDIC

Labeled EBCDIC format. *See also* EBCDIC.

library storage module

The library storage module (LSM) is a cylindrical shaped storage unit that houses up to 6000 tape cartridges. LSMs within the same ACS can exchange tape cartridges using pass through ports (PTPs).

local symbol

A symbol meaningful only to the module or DCL command procedure that defines it.

log file

Any file into which status and error messages are written to reflect the progress of a process. In SLS software, a log file is used to record the status and errors of save operations.

magazine

A physical container that holds from 5 to 11 tape cartridges (volumes). The magazine contains a set of logically bound volumes that reside in the MDMS database.

magazine database

The MDMS database that contains the magazine name and the volume names associated with that magazine.

media

A mass storage unit. Media provides a physical surface on which data is recorded.

Examples are magnetic tape, tape cartridge, and optical cartridge.

media set

A logical association of media, regardless of its physical location.

menu

A displayed list of options from which you make a selection.

named object set

A compound object set with an associated name.

note string

In SLS software, a sequence of alphanumeric characters that helps provide information about a volume. When performing a save operation using standby archiving, the first word in the note string is used to specify the archive class for that job.

For foreign volumes, SLS uses the first six characters of the note string for the recorded label.

object

An individual entry stored within the client file system. An object may be a single VMS file, an Oracle Rdb database area, a Kelso file, or a U*X file.

on-line history files

History record files. There are two types of history files: user and system. Both record save operations information that includes the names of the files and the volume used. Users who want a user save operations recorded in the on-line history files use the STORAGE SAVE/RECORD command.

OPCOM

The VMS Operator Communication Manager is an on-line communication tool that provides a method for users or batch jobs to request assistance from the operator, and allows the operator to send messages to interactive users.

OPER privilege

The level of privilege required by a system operator to suspend a SLS operation and to perform a variety of maintenance procedures on volumes, as well as archive files and saved system files.

out port

The physical opening in a jukebox where cartridges can be exported from the jukebox.

output file

A file that contains the results of a processing operation (for example, a file that contains the results of a restore).

pass through port

A pass through port (PTP) is a set of physical openings in adjacent LSMs which are used to exchange tape cartridges between LSMs belonging to the same ACS.

pool

See volume pool.

READALL privilege

Allows users read and header access to all files on the system. Refer to the *Guide to VMS System Security* for more information.

record

A set of related data treated as a unit of information. For example, in SLS software, each volume that is added to the SLS database has a record created that contains information on that volume.

record length

The length of a record in bytes. *See also* blocking factor.

recorded label

The label recorded on the media.

recording format

The unique arrangement of data on a volume according to a predetermined standard. Examples of recording format are BACKUP, EBCDIC and ANSI.

restore process

The method by which the contents of a file are recovered from a volume or volumes that contain the saved file. SLS software will restore file contents by reading BACKUP save sets from one or more volumes, extracting the file contents from

those save sets, and placing the information onto a Files-11 structured disk where the restored file can be accessed by a user.

restore request

A request to restore data from the archive to the client file system initiated either through the DCL command interface or the SLS window interface.

robot

See transport mechanism.

robot device

A tape or optical device that provides automatic loading of volumes, such as a TF867 or a TL820.

SLS software

The Storage Library System for OpenVMS software is a VMS layered software product that helps you to implement save and restore operations. SLS schedules immediate or periodic archive requests and maintains a directory of all archived files.

save process

The method by which copies of files are made on magnetic or optical cartridges for later recovery or for transfer to another site.

For BACKUP formatted volumes, a SLS save operation creates BACKUP save sets on magnetic tape, a system disk, or optical cartridge.

For foreign or EBCDIC formatted tapes, a SLS save operation creates copies of the original files and does not create history files.

See also backup process.

save set

A file created by the VMS Backup utility on a volume. When the VMS Backup utility saves files, it creates a file in BACKUP format called a save set on the specified output volume. A single BACKUP save set can contain numerous Files-11 files. Only BACKUP can interpret save sets and restore the files stored in the save set.

scratch date

In SLS software, the day on which an allocated storage volume is scheduled to go into the transition state or the free state.

server node

The node to which all SLS database requests are sent to be serviced. In a highavailability

configuration, when the active server node fails, another node in the OpenVMScluster system becomes the active server node.

simple object set

A list of included objects (files), an excluded list of objects, and object selection criteria. The simple object set is the simplest way of specifying objects to be moved in a data movement request.

slot

A vertical storage space for storing a cartridge. The storage racks and cabinets used in data centers contain multirow slots that are labeled to easily locate stored media.

standby archive process

A method that consolidates files interactively saved by users on a single volume or volume set.

standby archive request

A specific request issued by the user to archive specified files in a standby archive class.

standby archive session

A period of time during which the operator allows the detached process handling standby archive requests from users for a particular archive class to run. Only one standby archiving process can run at a time, therefore the operator must start archiving for one archive class, allow it to run for a period of time (or to completion), shut down that standby archive session, and start the session for the next archive class.

standby server process

Any server process that is not currently active. The standby server process waits and becomes active if the active server process fails.

state

See volume state.

SYSPRV privilege

The level of privilege required to install the SLS software and add user names to the system.

system backup

SLS system backup procedure. The system backup procedure usually uses the VMS Backup utility to save system files. Using DECscheduler, the [text] can direct SLS software to perform automatic save operations on a predetermined schedule.

tag template

A mechanism for implementing table driven command generation and message parsing. The tag template consists of a string of characters with embedded tags that identify either:

- fields to be inserted into a command being formatted
- parsable entities in a message being parsed

tape cartridge

A basic unit of media.

transition

A volume state. Volumes in the transition state are in the process of being deallocated, but are not yet fully deallocated. The transition state provides a grace period during which a volume can be reallocated to the original owner if necessary.

UASCII

Unlabeled ASCII format. *See* ASCII.

UIC

The abbreviation for user identification code. UIC is the pair of numbers assigned to users, files, pools, global sections, common event flag clusters, and mailboxes. The UIC determines the owner of an object. UIC-based protection determines the type of access available to the object for its owner, members of the same UIC group, system accounts, and other (world) users.

unlabeled

A recording format that does not include a recorded label.

user backup

A backup operation that uses the VMS Backup utility to save user files. A user backup operation is initiated by an individual user when they would like to make copies of a file or set of files on volumes for later recovery or for transfer to another site.

user report

A command file that searches the user history files for information on one or more files and generates a report. This report will display the volumes that contain copies of a particular file or set of files.

vault

An off-site storage location to where volumes are transferred for safekeeping.

VMS Backup utility

A VMS Operating System utility that performs save and restore operations on files, directories, and disks using the BACKUP recording format.

volume

A logical unit of data that is stored on media. A volume can be stored on a single magnetic tape or disk, or as in the case of an optical cartridge, can refer to one side

of double-sided media. A volume assigns a logical name to a piece of media, or to a side of double-sided media.

volume-days unit

One volume allocated for one day. MDMS enables you to measure volume usage by using a volume-days unit.

volume ID

The volume identification used to verify that the correct volume has been selected. The volume label should be the same as the volume ID.

volume report

A report that displays information about the volumes in the MDMS volume database.

volume set

One or more volumes logically connected in a sequence to form a single set. Volume sets are usually created when a single logical unit of data needs to be stored on more than one physical medium.

volume state

A volume status flag. In SLS software, volumes are placed in one of the following states:

- Free
- Allocated
- Transition
- Down

wildcard character

A nonnumeric or nonalphanumeric character such as an asterisk (*) or percent sign (%) that is used in a file specification to indicate "ALL" for a given field or portion of a field. Wildcard characters can replace all or part of the file name, file type, directory name or version number.

Index

A

- Abort Standby Archive 9-16
- Abort SYSCLN Processing 4-18
 - Description 4-18
 - Procedure 4-18
- Aborting 9-16
- Aborting Standby Archive 9-16
 - Description 9-16
 - Procedure 9-16
- Accounting for volume usage 15-11
- ACS Management Menu 13-29
 - Export Volume example of screen diagram 13-41
 - Export Volume(s) Screen Diagram 13-41
 - Import Volume 13-31
 - Import Volumes
 - screen diagram 13-31
 - Initialize Volume
 - screen diagram 13-34
 - Load Volume Onto Drive 13-37
 - Load Volume Onto Drive Screen Diagram 13-37
 - Unload Drive Screen Diagram 13-38
 - Unload Volume Screen Diagram 13-40
- ACS Managment Menu
 - Export Volume 13-41
 - Unload Drive 13-38
 - Unload Volume 13-40
- ADD_CLASS 9-18
- Archive Classes 9-17
- ARCHIVE_SBK.COM 9-4
- Authorize Class Access 9-19
- Automatic archiving 9-1
- Automatic Scheduling
 - Day Offset from a Week Offset 5-11
- Automatic scheduling
 - Day of week 6-10
 - Day Offset into a Month 5-10
 - System Backup Operation 6-7
 - Week Offset into a Month 5-11
- AUTOSEL 5-28
 - Allowable Values 5-30

B

- B1C.TEMPLATE 9-19
 - Example 9-20
- Backing up information
 - standby archiving 9-4

- Backup
 - OpenVMS 8-2

C

- CAPACITY_n 12-4
 - Change 17-7
 - Change Offsite Date 17-9
 - Change Onsite Date 17-7
 - change the off-site date 17-9
 - change the on-site date 17-8
 - change the vault name for the current process 17-9
 - change the volume location to off-site 17-1
 - change the volume location to on-site 17-2
 - change the volume locations 17-5
- Comamnds
 - RDSHOW 14-16
- Command file
 - BACKUP_TYPE 8-4
 - DRIVE_TYPE 8-5
 - QUALIFIERS_n 8-5
- Configuring
 - Local Area Network 14-6
 - Multiple Remote Nodes 14-11
 - RDF software 14-16
 - Single Remote Device 14-4
- CONTLOADOPT 5-5, 6-29

D

- Data Safety
 - consideration for VMS Backup Utility 4-20
 - considerations for VAX RMS Journaling 4-23
 - implementing with VAX RMS Journaling 4-23
- data safety 4-1
- Database
 - automatic backup operation 8-7
 - backup command file 8-7
 - Backup Process 8-2
 - history files 8-4
 - RMU/BACKUP qualifier 8-6
 - RMU/RESTORE 8-8
 - Support 8-1
 - TAPESTART.COM 8-3
 - Volume Reports and Backups 8-8
- Database Access Authorization 16-4
- Database Access Authorization Screen 16-4
- database backup 8-7
- Database Location 4-2
- DCSC-Controlled 13-26
- default location assignments 15-8
- define the Hexadecimal Protection Codes 6-4

- delete user history files 4-18
- DENS_n 12-3
- density 5-27
- Device Driver
 - HSC controller 13-6
 - K.SCSI 13-6
- Device Drivers
 - GK Driver 13-4
- Digital Cartridge Server Component 13-26
 - Unload Volume 13-40
- Direct Connect DSSI Devices 13-4
- disable printing a log file 5-39

E

- Expiration Times 9-1
- Export Volume(s), menu option 13-41
- Exporting
 - cartridges from a jukebox 13-21

F

- File Access 9-2
- File access
 - Special Cases of 9-2
- File expiration times 9-1
- file expiration times 9-1
- File Restoring 7-6
- File Retention
 - applying seith SET VOLUME 9-2
- File retention time
 - Graphic Look 9-2
 - Setting 9-3
- FILES 5-16
- free 16-3
- free volumes 16-3
- FRESTA 15-5
- Full Disk Restore 7-3
 - Description 7-3
 - Procedure 7-3

G

- Generating Save Set Names 5-27

H

- handle system backup volumes 5-31
- Hardware Configuration 13-3
 - determining 13-3
- Hardware configuration
 - determining 13-2

- HISDIR_n 4-3
- HISNAM_n 4-3
- How to
 - Create SLS system history files 4-3
 - create SLS User History 4-9
 - delete user history files 4-18
 - Start SYSCLN Processing 4-13
- How to Acces
 - the SYSCLN Menu 4-13

I

- Import Volumes menu option 13-31, 13-32
- Importing Cartridges 13-20
- Initialize RV02K 15-3
- Initialize Volume Series menu option 13-34
- Initialize Volumes 15-8
- Inquire Pending Jobs
 - description 10-1
 - Procedure 10-1
- Inquire SYSCLN Status 4-14
 - Description 4-14
 - Procedure 4-14
- Inquire SYSCLN status 4-12
 - Description 4-12
 - Procedure 4-13
- Installation planning B-1
- interrupt Standby Archive 9-17
- Introduction to MDMS 11-1
- Inventory Volume Series menu option 13-29

J

- Jukebox definition 15-2
 - exporting cartridges 13-21
 - importing cartridges 13-21
- Jukebox Slot definition 15-2

L

- Label templates 15-13
- Labels Printing 15-13
- Load Volume Onto Drive menu option 13-37
- Loading magazines 13-18
- LOG_FILE 5-7

M

- Magazine database
 - unbinding volumes 13-19
- magazine database 13-13
 - adding 13-13

- binding volumes 13-14
- binding volumes automatically 13-16
- binding volumes manually 13-14
- contents 13-19
- removing a magazine 13-18
- showing information 13-19
- showing volumes 13-20
- unbinding volumes 13-19

Magazine loaders 13-1

- magazine database 13-12
- TMSCP-served tapes 13-12

Magnetic Tape Jukeboxes 13-1

Manual System Backup 6-7

Manual System Backups 6-7

- description 6-7

Mass Movement 17-8

MAXSCRATCH 15-9

Media 12-1

Media library 12-7

Media Triplet

- assignment guidelines 12-4
- default assignments 12-4

Media Triplets 12-3

MEDIA_TYPE 5-28

Menus 2-1

- Administrator 2-1
- Operator 2-1
- User 2-1

MGRPRI 12-2

- TAPESTART.COM 12-2

MNTFLAGS 5-6

MTYPE_n 13-27

N

N_DRIVES 5-6

Naming SLS system history file directories 4-3

- sets 4-3

NET_REQUEST_TIMEOUT 12-2

- TAPESTART.COM 12-2

Network failure 14-22

NEXT_JOB 5-7

NODE_n 5-8

NODE_n assignment operation 5-13

NOTES 5-5

NULL_NODE 4-8

O

OFFSITE_DATE 5-6

ONSITE_DATE 5-6

Operation 6-1

- performing restore 7-1
- performing backup 6-7

Operations 5-1

Operator Menu

- restore screen 7-3

P

perform manual system backups 6-7

perform unattended system backups 6-28

Pointers 4-6

POST_PROCESS_EACH 5-17

POST_PROCESS_LAST 5-8

Post-processing execution sequence 5-15

- symbols enabled 5-16

PRE_PROCESS_EACH 5-17

PRE_PROCESS_FIRST 5-7

PREALLOC 5-28

Preprocessing execution sequence 5-15

- symbols enabled 5-16

print your backup listing file 6-12

PRINT_Q 5-39

Privilege Assignment 16-1

Privileges 16-1

- TMPMBX 14-16
- WORLD 14-16

default for volume management 16-1

default for volume management functions 16-1

NETMBX 14-16

SYSRV 14-16

PRIVS 5-24

PROGRESS 5-38

Q

QUALIFIERS_n 5-18

QUICKLOAD 5-29

- TAPESTART.COM 12-1

R

RACK command 17-5

RDEV_SERVER_INACTIVITY_TIMEOUT logical 14-25

RDF

- Network Control Program 14-17
- performance 14-18
- restrictions 14-14
- security 14-23

RDF Error Messages 14-25

RDF TMSCP-served tapes 13-12

RDserver Inactivity Timer 14-25
RDSHOW 14-16
Receiver 13-12
Record format HOLIDAYS.DAT 5-15
Remote Device Facility
 configuring 14-1
 restrictions 14-14
Remove volume when to 15-13
REMOVE_CLASS 9-18
Removing a Magazine 13-18
REPLY_MSG 5-7
Report of Files on System Backups 10-2
 description 10-2
 procedure 10-3
 user interface 10-2
report of files on system backups 10-2
Report of Files on User Backups 10-2
 description 10-2
 procedure 10-2
report of files on user backups 10-2
RESOPT 7-1
RESQUE 7-1
RESTORE command 7-2
restore nonlibrary volumes 7-2
Restore Operation 7-2
restore system files 7-3
restore user files 7-6

S

save nonlibrary volumes 6-5
Save Operation 6-1
Save Screen 6-18
 description 6-18
 procedure 6-20
Save set name generation 5-5
save set names 5-25
Save set restoring 7-6
save user files 6-18
Saves nonlibrary volumes 6-5
SAVESET_GEN restriction 5-26
SBUPDT_Q 5-5
schedule vault transfers 17-2
scheduling transfers 17-2
Scratch date
 user notification 15-10
Scratch date importance of 15-5
SCRATCH_DAYS 5-6
SEPARATE_VERSION 4-5
set expiration times 9-4
set file retention time 9-3
SET VOLUME applying file retention time 9-1

Setting File Retention 9-1
setting file retention 9-1
Shutdown 4-14
Shutdown Standby Archive 9-14
 description 9-14
 procedure 9-15
shutdown Standby Archive 9-14
Shutdown SYSCLN Processing 4-14, 4-15
 description 4-15
 procedure 4-16
 screen diagram 4-15
Shutting 9-14
SLS history files 4-20
 characterizing 4-4
 file sets 4-5
 how to create for system backup 4-3
 maximum file name size 4-5
 naming 4-3
 naming the processing queue 5-33
 naming the set 5-33
 storing node name 4-7
 transferring 4-8
 types 4-3
SLS User history files 4-3
Software 3-1
 client 3-1
 server 3-1
Stack loader tape jukeboxes 13-22
Standby Archive 9-6
 .ARKIVE files 9-8
 description 9-9
 menu option 9-9
 requirement 9-10
 screen display 9-9
Standby Archive Menu 9-9
 Abort Standby Archive 9-11
 abort standby archive 9-11
 Authorize Class Access for a User 9-11
 Inquire Pending Jobs 9-11
 Shutdown Standby Archive 9-11
 Start Up Standby Archive 9-11
Standby Archiving 9-6
 archive classes 9-7
 class naming conventions 9-17
 default class 9-20
 interval 9-7
 log files 9-8
 Operator Menu 9-9
 Requirement 9-6
 Restrictions 9-6
Standby archiving 9-1
start standby archiving 9-11

- Start the SYSCLN Process 4-13
- start the SYSCLN process 4-14
- Start Up Standby Archive 9-11
 - description 9-12
- STATUS_MAIL 5-6
- STORAGE 13-14
 - ADD VOLUME 13-14
 - BIND 13-15
 - IMPORT 13-15
 - INVENTORY 13-16
 - REMOVE 13-19
 - SHOW MAGAZINE 13-19
 - UNBIND 13-19
- STORAGE STARTUP command 9-11
- Symbols 12-1
 - ALLDEV 12-12, 14-15
 - ALLTIM 12-12
 - CAPACITY_n 12-4
 - DCSC_DRIVES 13-27
 - DCSC_n_NODE 13-27
 - DENS_n 12-3
 - DRIVES_n 12-3
 - MTYPE_n 12-3
 - SELDEV 12-12, 14-15
 - TAPESTART.COM 12-1
 - Volume Management 12-7
- SYSBAK command file 5-2
 - AUTOSEL 5-5, 6-28
 - CONTINUE 5-5
 - DAYS_n 5-8
 - DENSITY 5-6
 - DRIVE_TYPE 5-6
 - FULL 5-5
 - HISTORY_SET 5-5
 - LISTING_GEN 5-5
 - LOG_FILE 5-7
 - MEDIA_TYPE 5-28
 - MNTFLAGS 5-6
 - N_DRIVES 5-36
 - NEXT_JOB 5-7
 - NODE_n 5-8
 - NOTES 5-36
 - OFFSITE_DATE 5-6
 - ONSITE_DATE 5-6
 - POST_PROCESS_EACH 5-8
 - POST_PROCESS_LAST 5-8
 - PRE_PROCESS_EACH 5-7
 - PRE_PROCESS_FIRST 5-7
 - PREALLOC 5-28
 - PRINT_Q 5-39
 - PRIVS 5-4
 - Progress 5-37
 - PROTECTION 5-27
 - QUALIFIERS 5-4
 - QUALIFIERS_n 5-18
 - QUICKLOAD 5-29
 - REEL_SIZE 5-5
 - REPLY_MSG 5-7
 - SAVESET_GEN 5-25
 - SBUPDT_Q 5-33
 - SCRATCH_DAYS 5-34
 - STATUS_MAIL 5-38
 - SUMMARY_FILE 5-40
 - TAPE_LABELS 5-7
 - TAPE_POOL 5-28
 - TIME_n 5-8
- SYSBAK.TEMPLATE 5-3
- SYSBK command file
 - CONTLOADOPT 5-5
- SYSCLN 4-10
- SYSCLN Menu 4-12
 - Abort SYSCLN Processing 4-12
 - description 4-12
 - Inquire SYSCLN status 4-12
 - menu options 4-13
 - procedure 4-13
 - Shutdown SYSCLN Processing 4-14
 - Start SYSCLN Processing 4-14
- System backup operation 5-1
 - acknowledging loaded volumes 5-30
 - additional mount actions 5-24
 - allocating volumes 5-30
 - automatic scheduling 5-8
 - automatic volume selection 5-31
 - automatically scheduled 5-8
 - creating command files 5-8
 - days to run 5-11
 - device control 5-36
 - file protection 5-24
 - files created 5-41
 - format 6-2
 - functional consideration 5-2
 - generating save set names 5-25
 - listing file format 5-39
 - log files 5-41
 - manual 5-1
 - media resource allocation 5-32
 - media type 5-28
 - number of drives 5-36
 - print your listing file 5-39
 - printing volume labels 5-35
 - privileges 5-24
 - reporting status by mail 5-38
 - skipping on holidays 5-9

- SLS software features 5-1
- specifying SLS system history files 5-33
- standalone system 5-14
- status and information reporting 5-38
- summary files 5-40
- type of 5-18
- unattended 6-27
- volume characteristics 5-27
- volume label mismatch 9-6
- volume pool A-3
- volume retention 9-1

T

- Tape devices 13-12
 - loading volumes 13-18
 - unloading volumes 13-18
- Tape jukebox 13-1
 - customizing robotically controlled devices 13-2
- TAPEPURGE_WORK 15-10
- TAPESTART 13-2
- TAPESTART.COM 12-1, 13-2
 - ALLDEV 12-12
 - ALLOCSRATCH 15-9
 - ALLOCSIZE 12-7
 - ALLOSCRATCH 15-9
 - BACKUP_DEFAULT_REEL 6-4
 - BACKUP_FINISH 6-5
 - BACKUPSCRATCH 12-13
 - BACKUPSIZE 6-5
 - BAKFMT 6-2
 - BAKOPT 6-3
 - BAKQUE 6-5
 - CLEANUP_Q 12-13
 - customizing 13-2
 - DB_NODES 12-1
 - DCSC_DRIVES 13-27
 - FRESTA 12-7, 15-10
 - HISDIR_n 4-3
 - HISNAM_n 4-4
 - LBL 12-7
 - LOC 12-7
 - MAXSCRATCH 12-7, 15-9
 - media triplet for tape devices 13-27
 - MGRPRI 12-2
 - NET_REQUEST_TIMEOUT 12-2
 - PRI 12-1
 - PRIMAST 12-2
 - PRIV_CLEAN 12-10, 16-1
 - PRIV_LABEL 12-10, 16-1
 - PRIV_MAXSCR 12-10, 16-1
 - PRIV_MODANY 12-10, 16-1

- PRIV_MODOWN 12-10, 16-1
- PRIV_SEEANY 12-10, 16-1
- QUICKLOAD 12-10
- RESOPT 7-1
- RESQUE 7-1
- RESTORE_FINISH 7-2
- TAPEPURGE_MAIL 12-7, 15-10
- TAPEPURGE_WORK 12-7, 15-10
- TRANS_AGE 12-8
- UNATTENDED_BACKUPS 12-14
- VERBOSE 12-2
- VLT 12-7, 17-1
 - volume management symbols 12-7

- TL810 13-1
- TL820 13-1
 - exporting cartridges 13-21
- TL891 13-23
- TOPERS 12-7
- TRANS_AGE 12-8

U

- unattended system backup operation 6-27
- unattended system backup restrictions 6-27
- Unbinding a volume 13-19
- Unload Drive menu option 13-38
- Unload Volume menu option 13-40
- use the Report of Files on User Backups Menu 10-2
- User Menu 2-1
 - accessing 2-4
 - diagram 2-4
 - options 2-5
- using preallocated volume sets 6-30

V

- VAULT command 17-5
- Vault dates how to schedule 17-2
- Vault management 17-1
- Vault Management Menu 17-5
 - Change Name for Current Process 17-9
 - change name for current process 17-7
 - Change Off-site Date 17-9
 - Change On-site Date 17-8
 - Change to Off-site 17-7
 - Change to On-site 17-7
 - Mass Movement 17-8
- Vault Storage 17-1
 - concepts 17-1
- VAULT_DATES.DAT 17-2
- VAX RMS Journal 4-1
- VAX RMS Journaling 4-1

- VAX Volume Shadowing 4-1
- VMS 4-23
- VMS Backup utility 4-1
- Volume
 - definition 15-1
 - Double-Sided Media 15-3
 - Single-Sided Media 15-3
- Volume Accounting Period 15-11
- Volume database fields
 - modify with PRIV_MODANY 16-3
- Volume Default Scratch Time 15-9
- Volume ID definition 15-1
- volume labels do not match 6-27
- Volume Lifecycle definition 15-1
- Volume Management Privileges 16-1
 - Default Assignments 16-1
- Volume Pool
 - Authorizing User Access 16-7
- Volume Pool Authorization 16-7
 - Deleting an User Entry 16-10
 - Editing an User Entry 16-10
 - Finding an User Entry 16-9
- Volume Pool Authorization Screen 16-7
 - Fields 16-8
- Volume Pool Authorizing Access 16-8
- Volume Pool definition 15-2
- Volume Size default for STORAGE SAVE 6-5
- Volume States 15-3
 - Changing 15-6
 - Determining 15-5
- Volume Transition Time 15-6
- Volume Use Report 15-10
- Volumes 15-8
 - Initializing 15-8
 - Initializing a series 13-34
 - Inventoring 13-30
 - Loading 13-37
 - Unloading 13-39

W

- Week Offset Assignment 5-11
- Why 1-1
- WRITE_DEFAULT 9-18
- WRITE_USER 9-18