

# Hierarchical Storage Management for OpenVMS

---

## Guide to Operations

Order Number: AA-PWQ3R-TE

This manual contains information and guidelines for operation of HSM and Media, Device and management Services (MDMS).

**Required Operating System** OpenVMS V6.2 or higher

**Required Software** Storage Library System for OpenVMS V2.9B or higher, **or** Media, Device and Management Services for OpenVMS Version 2.9C, 2.9D, 3.1, 3.1A, 3.2, 3.2A, V4.0 or V4.0A

DECnet (Phase IV) or DECnet-Plus (Phase V)

TCP/IP Services for OpenVMS

**Revision/Update Information:** This manual replaces version AA-PWQ3Q-TE.

Software Version: HSM Version V4.0A

**Compaq Computer Corporation**  
Houston, Texas

---

**April 2002**

© 2002 Compaq Information Technologies Group, L.P

Compaq, the Compaq logo, OpenVMS, VAX and Tru64 are trademarks of Compaq Information Technologies Group, L.P. in the U.S. and/or other countries. UNIX is a trademark of The Open Group in the U.S. and/or other countries. All other product names mentioned herein may be trademarks of their respective companies.

Confidential computer software. Valid license from Compaq required for possession, use or copying. Consistent with FAR 12.211 and 12.212, Commercial Computer Software, Computer Software Documentation, and Technical Data for Commercial Items are licensed to the U.S. government under vendor's standard commercial license.

Compaq shall not be liable for technical or editorial errors or omissions contained herein. The information in this document is provided "as is" without warranty of any kind and is subject to change without notice. The warranties for Compaq products are set forth in the express limited warranty statements accompanying such products. Nothing herein should be construed as constituting an additional warranty.

Compaq service tool software, including associated documentation, is the property of and contains confidential technology of Compaq Computer Corporation. Service customer is hereby licensed to use the software only for activities directly relating to the delivery of, and only during the term of, the applicable services delivered by Compaq or its authorized service provider. Customer may not modify or reverse engineer, remove, or transfer the software or make the software or any resultant diagnosis or system management data available to other parties without Compaq's or its authorized service provider's consent. Upon termination of the services, customer will, at Compaq's or its service provider's option, destroy or return the software and associated documentation in its possession.

Printed in the U.S.A.

---

# Contents

Preface .....	xv
---------------	----

## 1 Introduction to HSM

1.1 Storage Management in the OpenVMS Environment .....	1-1
1.1.1 Data Categories .....	1-1
1.1.2 Device Capacity, Cost, and Performance .....	1-1
1.1.3 Storage Management Planning .....	1-2
1.2 Storage Management with HSM .....	1-3
1.2.1 File Headers and Location .....	1-3
1.2.2 Controlling File Movement .....	1-3
1.3 HSM Storage Management Concepts .....	1-4
1.3.1 Shelf .....	1-4
1.3.2 Archive Class .....	1-4
1.3.3 HSM Policies .....	1-4
1.4 The Shelving Process .....	1-4
1.4.1 Starting the Shelving Process .....	1-4
1.4.2 File Selection for Explicit Shelving .....	1-5
1.4.3 File Selection for Implicit Shelving .....	1-5
1.4.4 Modifying File Attributes of a Shelved File .....	1-6
1.5 The Unshelving Process .....	1-6
1.5.1 Starting the Unshelving Process .....	1-6
1.5.2 Process Default Unshelving Action .....	1-6
1.5.3 The Results of Unshelving a File .....	1-7
1.5.4 Handling Duplicate Requests to Unshelve a File .....	1-7
1.6 The Preshelving Process .....	1-7
1.7 The Unpreshelving Process .....	1-7
1.8 File Headers and Access Security .....	1-8
1.9 HSM File State Diagram .....	1-8
1.10 HSM Cache .....	1-8
1.10.1 HSM Operations with Cache .....	1-9
1.10.2 Cache in the Shelving and Preshelving Processes .....	1-9
1.10.3 Unshelving from Cache .....	1-9
1.10.4 Exceeding Cache Capacity .....	1-10
1.10.5 Flushing Cache .....	1-10
1.11 HSM Catalogs .....	1-10
1.12 HSM Archive Repacking .....	1-10
1.13 HSM Software Modes .....	1-11
1.13.1 HSM Basic Mode Functions .....	1-11
1.13.2 HSM Plus Mode Functions .....	1-11
1.14 Media Types for HSM Basic Mode .....	1-12
1.15 Device Support .....	1-15
1.16 Online Devices Not Supported for HSM Operations .....	1-15
1.17 HSM Support for Remote Operations .....	1-15

## 2 Understanding HSM Concepts

2.1	The HSM Environment	2-1
2.2	The HSM Facility	2-2
2.2.1	HSM Mode	2-2
2.2.2	HSM Operations	2-3
2.2.3	Shelf Servers	2-3
2.2.4	Event Logging	2-4
2.3	The Shelf	2-5
2.3.1	Using Multiple Shelf Copies	2-5
2.3.2	Defining Shelf Copies	2-6
2.3.2.1	Archive Lists and Restore Archive Lists	2-6
2.3.2.2	Primary and Secondary Archive Classes	2-7
2.3.2.3	Multiple Shelf Copies	2-7
2.3.3	Shelving Operations	2-8
2.3.4	Shelf Catalog	2-8
2.3.5	Save Time	2-8
2.3.6	Number of Updates for Retention	2-8
2.4	HSM Basic Mode Archive Class	2-9
2.5	HSM Plus Mode Archive Class	2-10
2.6	Device	2-10
2.6.1	Sharing and Dedicating Devices	2-10
2.6.2	Device Operations	2-11
2.6.3	Devices and Archive Classes	2-12
2.6.4	Magazine Loaders for HSM Basic Mode	2-13
2.6.5	Compatible Media for HSM Basic Mode	2-14
2.6.6	Automated Loaders and HSM Plus Mode	2-15
2.7	Volume	2-15
2.7.1	Shelf	2-15
2.7.2	Shelving Operations	2-16
2.7.3	Volume Policy	2-16
2.7.4	High Water Mark	2-16
2.7.5	Files Excluded from Shelving	2-16
2.8	Cache Usage	2-17
2.8.1	Advantages and Disadvantages of Using a Cache	2-17
2.8.2	Cache Flushing	2-17
2.8.3	Cache Attributes	2-18
2.8.3.1	Timing of Shelf Copies	2-18
2.8.3.2	Cache Block Size	2-18
2.8.3.3	High Water Mark	2-18
2.8.3.4	Cache Flush Interval	2-18
2.8.3.5	Cache Flush Delay	2-18
2.8.3.6	Delete and Modify File Action	2-19
2.8.4	Optimizing Cache Usage	2-19
2.8.5	Using Magneto-Optical Devices	2-19
2.9	Policy	2-19
2.9.1	HSM Policy Options	2-20
2.9.2	Trigger Events	2-20
2.9.2.1	Scheduled Trigger	2-21
2.9.2.2	User Disk Quota Exceeded Trigger	2-21
2.9.2.3	High Water Mark Trigger	2-22
2.9.2.4	Volume Full Trigger	2-22
2.9.3	File Selection Criteria	2-22

2.9.4	Policy Goal	2-24
2.9.5	Make Space Requests and Policy	2-24
2.10	Schedule	2-25
2.10.1	Online Volumes	2-25
2.10.2	Execution Timing and Interval	2-25
2.10.3	Server Node	2-25
2.11	HSM System Files and Logical Names	2-26
2.11.1	HSM\$MANAGER	2-26
2.11.2	HSM\$LOG	2-27
2.11.3	HSM\$REPACK	2-27

### 3 Customizing the HSM Environment

3.1	Configuring a Customized HSM Environment	3-1
3.1.1	Customizing the HSM Facility	3-1
3.1.2	Creating Shelf Definitions	3-1
3.1.3	Enabling and Disabling a Shelf Definition	3-2
3.1.4	Modifying Archive Classes	3-2
3.1.5	Creating Device Definitions	3-3
3.1.6	Modifying Device Definitions	3-3
3.1.7	Enabling and Disabling a Volume Definition	3-3
3.1.8	Working with Caches	3-3
3.1.9	Enabling and Disabling a Policy Definition	3-4
3.1.10	Scheduling Policy Executions	3-4
3.2	Implementing Shelving Policies	3-5
3.2.1	Determining the Disk Volumes	3-5
3.2.2	Creating Volume Definitions	3-5
3.2.3	Determining File Selection Criteria	3-6
3.2.4	Creating Policy Definitions	3-6
3.2.5	Using Expiration Dates	3-7
3.2.6	Creating Schedule Definitions	3-8
3.2.7	Enabling Preventive Policy	3-8

### 4 Using HSM

4.1	What the User Sees in an HSM Environment	4-1
4.1.1	Identifying Shelved Data using the DIRECTORY Command	4-1
4.1.1.1	DIRECTORY/FULL	4-2
4.1.1.2	DIRECTORY/FULL for Unpopulated Index Files	4-2
4.1.1.3	DIRECTORY/FULL for Populated Indexed Files	4-3
4.1.1.4	DIRECTORY/SHELVED_STATE	4-4
4.1.1.5	DIRECTORY/SIZE	4-4
4.1.2	Accessing Files	4-5
4.1.3	Decreasing Volume Full and Disk Quota Exceeded Errors	4-5
4.1.4	Viewing Messages	4-6
4.2	Controlling Shelving and Unshelving	4-6
4.2.1	Automatic Shelving Operations	4-6
4.2.2	User-Controlled Shelving Operations	4-6
4.2.3	Unshelving Files	4-8
4.3	Finding Lost Data	4-8
4.4	Working with Remote Files	4-8
4.5	Resolving Duplicate Operations on the Same File	4-8
4.5.1	Resolving Conflicting Operations on the Same File	4-9

4.6 Controlling Other HSM Functions .....	4-9
---	-----

## 5 Managing the HSM Environment

5.1 Dismounting Disks .....	5-2
5.2 Copying Shelved Files .....	5-2
5.3 Renaming Disks .....	5-3
5.4 Restoring Files to a Different Disk .....	5-4
5.5 Protecting System Files from Shelving .....	5-4
5.5.1 Critical HSM Product Files .....	5-4
5.5.2 OpenVMS System Files and System Disks .....	5-5
5.5.3 Files Not Shelved .....	5-6
5.6 DFS, NFS and PATHWORKS Access Support .....	5-6
5.6.1 DFS Access .....	5-6
5.6.2 NFS Access .....	5-6
5.6.3 PATHWORKS .....	5-7
5.6.4 Logical Names for NFS and PATHWORKS Access .....	5-8
5.7 Ensuring Data Safety with HSM .....	5-8
5.7.1 Access Control Lists for Shelved Files .....	5-8
5.7.2 Handling Contiguous and Placed Files .....	5-9
5.8 Using Backup Strategies with HSM .....	5-9
5.8.1 Backing up Critical HSM Files .....	5-9
5.8.1.1 Defining a Backup Strategy .....	5-9
5.8.1.2 Using OpenVMS BACKUP to Save the Files .....	5-9
5.8.1.3 Maintaining a Manual Copy of the Files .....	5-10
5.8.2 Backing Up Shelved Data .....	5-10
5.8.2.1 Considerations for OpenVMS BACKUP and Shelving .....	5-10
5.8.2.2 Using Multiple HSM Archive Classes for Backup .....	5-10
5.8.2.3 Storing HSM Archive Classes Offsite .....	5-11
5.8.3 Backing Up Data Stored in an Online Cache .....	5-11
5.8.3.1 Flushing the Cache .....	5-11
5.9 Finding Lost User Data .....	5-11
5.10 Disaster Recovery .....	5-12
5.10.1 Recovering Data Shelved Through HSM .....	5-12
5.10.2 Recovering Critical HSM Files .....	5-12
5.10.3 Recovering Boot-Up Files .....	5-13
5.10.4 Reshelving an Archive Class .....	5-13
5.11 Maintaining Shelving Policies .....	5-13
5.11.1 The HSM Policy Model .....	5-14
5.11.1.1 Concepts of HSM Policy .....	5-14
5.11.1.2 Policy Governs the Shelving Process .....	5-15
5.11.1.3 The Balance to Achieve When Implementing Policy .....	5-16
5.11.2 HSM Policy Situations and Resolutions .....	5-16
5.11.2.1 Situation : Volume Occupancy Full Event .....	5-16
5.11.2.2 Situation : Shelving Goal Not Reached .....	5-17
5.11.2.3 Situation : Frequent Reactive Shelving Requests .....	5-18
5.11.2.4 Situation : Application and User Performance Impeded .....	5-19
5.11.3 Ranking Policy Execution .....	5-20
5.12 Managing HSM Catalogs .....	5-21
5.13 Repacking Archive Classes .....	5-23
5.13.1 Repack Performance .....	5-25
5.14 Replacing and Creating Archive Classes .....	5-25
5.15 Replacing A Lost or Damaged Shelf Volume .....	5-25

5.16	Catalog Analysis and Repair	5-26
5.17	Consolidated Backup with HSM	5-28
5.17.1	Setting up SLS	5-29
5.17.2	Preshelving Files	5-29
5.17.3	Nightly Backups	5-30
5.17.4	Restoring Volumes	5-31
5.17.5	Restoring Files	5-31
5.17.6	Repacking	5-32
5.17.7	Other Recommendations	5-32
5.18	Determining Cache Usage	5-32
5.19	Maintaining File Headers	5-32
5.19.1	Determining File Header Limit	5-32
5.19.2	Specifying a Volume's File Headers	5-33
5.19.3	Extending the Index File	5-33
5.19.4	Maintaining the Number of File Headers	5-33
5.20	Event Logging	5-33
5.20.1	Accessing the Logs	5-34
5.20.2	Shelf Handler Log Entries	5-34
5.21	Activity Logging	5-36
5.22	Converting from Basic Mode to Plus Mode	5-37
5.22.1	Shutting Down the Shelf Handler	5-38
5.22.2	Disabling the Shelving Facility	5-38
5.22.3	Entering Information for MDMS	5-38
5.22.4	Changing from Basic Mode to Plus Mode	5-38
5.22.5	Restarting the Shelf Handler	5-38
5.22.6	Using the Same Archive Classes	5-39
5.22.7	Enabling the Facility	5-39
5.22.8	Example Mode Conversion	5-39

## 6 Operator Activities in the HSM Environment

6.1	Enabling the Operator Interface	6-1
6.2	Loading and Unloading Single Tapes for HSM Basic Mode	6-1
6.2.1	Load Volume, No Reply Needed	6-2
6.2.2	Load Volume	6-2
6.2.3	Reinitialize Volume	6-2
6.2.4	Volume Initialization Confirmation	6-2
6.2.5	Unload Label Request	6-3
6.3	Responding to BACKUP Requests for HSM Basic Mode	6-3
6.4	Working with Magazine Loaders for HSM Basic Mode	6-3
6.4.1	Load Magazine	6-3
6.4.2	Illegal Magazine	6-3
6.4.3	Unload Magazine	6-3
6.5	Working with Automated Loaders for HSM Plus Mode	6-4
6.5.1	Providing the Correct Magazine	6-4
6.5.2	Providing the Correct Volume for a TL820	6-5
6.6	Other MDMS Messages	6-5
6.7	Drive Selection and Reservation Messages for Both Modes	6-6
6.7.1	Unavailable Drive	6-6
6.7.2	Reservation Stalled	6-6
6.7.3	Wrong Tape Label	6-7
6.8	Informational Operator Messages	6-7

## 7 Solving Problems with HSM

7.1	Introduction to Troubleshooting	7-1
7.2	Troubleshooting Tools	7-2
7.2.1	Startup Logs	7-2
7.2.2	After a problem occurs, the first things you should check are the event logs:	7-3
7.2.3	Activity Log	7-3
7.2.4	SMU LOCATE	7-3
7.2.5	UNSHELVE/OVERRIDE	7-4
7.2.6	SMU RANK	7-4
7.2.7	SMU SET and SHOW Commands	7-4
7.2.8	MDMS Tools for HSM Plus Mode	7-5
7.3	Installation Problems	7-5
7.4	HSM Startup Problems	7-6
7.4.1	SMU Does Not Run	7-6
7.4.2	The Shelf Handler Does Not Start Up	7-6
7.4.3	Policy Execution Process Does Not Start Up	7-8
7.4.4	HSM Does Not Shut Down	7-8
7.4.5	Shelving and SMU Commands Do Not Work	7-9
7.5	Mass Shelving	7-9
7.6	Shelving on System Disks	7-10
7.6.1	HSM Plus Mode (MDMS) Problems	7-11
7.7	HSM VMScLuster Problems	7-11
7.8	Online Disk Problems	7-13
7.9	Cache Problems	7-14
7.10	Magneto-Optical Device Problems	7-15
7.11	Offline Device Problems	7-16
7.12	Magazine and Robotic Loader Problems	7-17
7.13	Shelving Problems	7-19
7.14	Unshelving Problems	7-20
7.15	Policy Problems	7-21
7.16	HSM System File Problems	7-23
7.17	HSM Limitations	7-23
7.17.1	OpenVMS Limit on File Headers	7-24
7.17.2	Attempting to Cancel Execution of a Shelved File	7-24
7.17.3	Automatic Unshelving of Files across a Network	7-24
7.17.4	Opening and Deleting RMS Indexed Files	7-25

## 8 What is MDMS?

8.1	MDMS Objects	8-1
8.2	MDMS Interfaces	8-2

## 9 Basic MDMS Operations

9.1	MDMS User Interfaces	9-1
9.2	DCL Interface	9-1
9.2.1	Syntax Overview	9-1
9.2.2	Object Lists	9-2
9.2.3	Qualifier List	9-3
9.2.4	Inherit	9-3
9.2.5	Symbols	9-3
9.2.6	Help and Reference	9-3



9.3	User Interface Restrictions	9-4
9.4	Graphical User Interface	9-4
9.4.1	Starting MDMSView	9-5
9.4.1.1	OpenVMS Systems	9-5
9.4.1.2	Windows Systems	9-5
9.4.2	Look and Feel	9-5
9.4.3	Logging In	9-6
9.4.4	Selecting A View	9-7
9.4.5	Creating Objects	9-8
9.4.6	Showing and Modifying Objects	9-10
9.4.7	Deleting Objects	9-11
9.4.8	Viewing Relationships Between Objects	9-11
9.4.9	Performing Operations on Objects	9-13
9.4.10	Showing Current Operations	9-13
9.4.11	Reporting on Volumes	9-14
9.4.12	Viewing MDMS Audit and Event Logging	9-16
9.4.13	Errors	9-17
9.4.14	Help	9-17
9.5	Access Rights for MDMS Operations	9-18
9.5.1	Description of MDMS Rights	9-18
9.5.1.1	Low Level Rights	9-18
9.5.1.2	High Level Rights	9-19
9.5.2	Granting MDMS Rights	9-19
9.6	Creating, Modifying, and Deleting Object Records	9-21
9.6.1	Creating Object Records	9-21
9.6.1.1	Naming Objects	9-21
9.6.1.2	Differences Between the CLI and GUI for Naming Object Records	9-22
9.6.2	Inheritance on Creation	9-22
9.6.3	Referring to Non-Existent Objects	9-22
9.6.4	Rights for Creating Objects	9-23
9.6.5	Modifying Object Records	9-23
9.6.6	Protected Attributes	9-23
9.6.7	Rights for Modifying Objects	9-23
9.6.8	Deleting Object Records	9-23
9.6.9	Reviewing Managed Objects for References to Deleted Objects	9-24
9.6.10	Reviewing DCL Command Procedures for References to Deleted Objects	9-24
9.6.11	Rights for Deleting Objects	9-27

## 10 Media Management

10.1	MDMS Domain Configuration	10-1
10.2	Domain	10-1
10.2.1	ABS Rights	10-2
10.2.2	Application Rights	10-2
10.2.3	Check Access	10-2
10.2.4	Deallocate State	10-2
10.2.5	Default Rights	10-2
10.2.6	Mail Users	10-2
10.2.7	Maximum Scratch Time	10-3
10.2.8	Media Type	10-3
10.2.9	Offsite Location	10-3
10.2.10	Onsite Location	10-3
10.2.11	OPCOM Classes	10-3

10.2.12	Operator Rights	10-3
10.2.13	Protection	10-3
10.2.14	Relaxed Access	10-4
10.2.15	Request ID	10-4
10.2.16	Scheduler Type	10-4
10.2.17	Scratch Time	10-4
10.2.18	SYSRV	10-4
10.2.19	Transition Time	10-5
10.2.20	User Rights	10-5
10.3	Drives	10-5
10.3.1	Access	10-5
10.3.2	Automatic Reply	10-5
10.3.3	Device	10-5
10.3.4	Disabled	10-6
10.3.5	Drive Number	10-6
10.3.6	Groups	10-6
10.3.7	Jukebox	10-6
10.3.8	Media Types	10-6
10.3.9	Nodes	10-6
10.3.10	Read-Only Media Types	10-6
10.3.11	Shared	10-6
10.3.12	Stacker	10-7
10.3.13	State	10-7
10.3.14	Allocate Drive (DCL Only)	10-7
10.3.15	Deallocate Drive (DCL Only)	10-8
10.3.16	Load Drive	10-8
10.3.17	Unload Drive	10-8
10.4	Groups	10-9
10.4.1	Nodes	10-9
10.5	Jukeboxes	10-9
10.5.1	Access	10-9
10.5.2	ACS ID	10-9
10.5.3	Automatic Reply	10-9
10.5.4	Cap Size	10-10
10.5.5	Control	10-10
10.5.6	Disabled	10-10
10.5.7	Groups	10-10
10.5.8	Library ID	10-10
10.5.9	Location	10-10
10.5.10	LSM ID	10-10
10.5.11	Nodes	10-11
10.5.12	Robot	10-11
10.5.13	Slot Count	10-11
10.5.14	State	10-11
10.5.15	Threshold	10-11
10.5.16	Topology	10-12
10.5.17	Usage	10-12
10.5.18	Inventory Jukebox	10-12
10.6	Locations	10-13
10.6.1	Parent Location	10-14
10.6.2	Spaces	10-14
10.7	Magazines	10-14

10.7.1	Jukebox, Start Slot and Position	10-14
10.7.2	Onsite and Offsite Locations and Dates	10-15
10.7.3	Slot Count	10-15
10.7.4	Spaces	10-15
10.7.5	Move Magazine(s)	10-15
10.8	Media Types	10-16
10.8.1	Capacity	10-16
10.8.2	Compaction	10-16
10.8.3	Density	10-16
10.8.4	Length	10-16
10.9	Node	10-16
10.9.1	Database Server	10-17
10.9.2	Disabled	10-17
10.9.3	OPCOM Class	10-17
10.9.4	Transports and Full Names	10-17
10.10	Pools	10-17
10.10.1	Authorized Users	10-18
10.10.2	Default Users	10-18
10.10.3	Threshold	10-18
10.11	Volumes	10-18
10.11.1	Allocation Fields - Account, Username, UIC and Job	10-20
10.11.2	Allocation and Movement Dates	10-20
10.11.3	History Dates	10-21
10.11.4	State	10-21
10.11.5	Media Types	10-22
10.11.6	Pool	10-22
10.11.7	Previous and Next Volumes	10-22
10.11.8	Placement - Jukebox, Magazine, Locations, Drive	10-23
10.11.9	Formats - Brand, Format, Block Factor, Record Size	10-23
10.11.10	Protection	10-24
10.11.11	Counters	10-24
10.11.12	Allocate Volume	10-24
10.11.13	Allocate Volume(s) by Selection Criteria	10-25
10.11.14	Deallocate Volume	10-25
10.11.15	Bind Volume	10-26
10.11.16	Unbind Volume	10-26
10.11.17	Load Volume	10-27
10.11.18	Unload Volume	10-27
10.11.19	Move Volume(s)	10-27
10.11.20	Initialize Volume(s)	10-28

## 11 MDMS Configuration

11.1	The MDMS Management Domain	11-1
11.1.1	The MDMS Database	11-2
11.1.1.1	Database Performance	11-3
11.1.1.2	Database Safety	11-3
11.1.1.3	Moving the MDMS Database	11-5
11.1.2	The MDMS Process	11-6
11.1.2.1	Server Availability	11-6
11.1.2.2	The MDMS Account	11-7
11.1.3	The MDMS Start Up File	11-7
11.1.3.1	MDMS\$DATABASE_SERVERS - Identifies Domain Database Servers	11-8

11.1.3.2	MDMS\$LOGFILE_LOCATION .....	11-9
11.1.3.3	MDMS Shut Down and Start Up .....	11-9
11.1.4	Managing an MDMS Node .....	11-9
11.1.4.1	Defining a Node's Network Connection .....	11-9
11.1.4.2	Defining How the Node Functions in the Domain .....	11-10
11.1.4.3	Enabling Interprocess Communication .....	11-10
11.1.4.4	Describing the Node .....	11-11
11.1.4.5	Communicating with Operators .....	11-11
11.1.5	Managing Groups of MDMS Nodes .....	11-11
11.1.6	Managing the MDMS Domain .....	11-12
11.1.6.1	Domain Configuration Parameters .....	11-12
11.1.6.2	Domain Options for Controlling Rights to Use MDMS .....	11-12
11.1.6.3	Domain Default Volume Management Parameters .....	11-13
11.1.7	MDMS Domain Configuration Issues .....	11-13
11.1.7.1	Adding a Node to an Existing Configuration .....	11-13
11.1.7.2	Removing a node from an existing configuration .....	11-14
11.2	Configuring MDMS Drives, Jukeboxes and Locations .....	11-14
11.2.1	Configuring MDMS Drives .....	11-14
11.2.1.1	How to Describe an MDMS Drive .....	11-14
11.2.1.2	How to Control Access to an MDMS Drive .....	11-15
11.2.1.3	How to Configure an MDMS Drive for Operations .....	11-15
11.2.1.4	Determining Drive State .....	11-15
11.2.1.5	Adding and Removing Managed Drives .....	11-15
11.2.1.6	Configuring MDMS Jukeboxes .....	11-16
11.2.1.7	How to Describe an MDMS Jukebox .....	11-16
11.2.1.8	How to Control Access to an MDMS Jukebox .....	11-16
11.2.1.9	How to Configure an MDMS Jukebox for Operations. ....	11-16
11.2.1.10	Attribute for DCSC Jukeboxes .....	11-16
11.2.1.11	Attributes for MRD Jukeboxes .....	11-16
11.2.1.12	Determining Jukebox State .....	11-17
11.2.1.13	Magazines and Jukebox Topology .....	11-17
11.2.2	Summary of Drive and Jukebox Issues .....	11-18
11.2.2.1	Enabling MDMS to Automatically Respond to Drive and Jukebox Requests .....	11-18
11.2.2.2	Creating a Remote Drive and Jukebox Connection .....	11-19
11.2.2.3	How to Add a Drive to a Managed Jukebox .....	11-19
11.2.2.4	Temporarily Taking a Managed Device From Service .....	11-19
11.2.2.5	Changing the Names of Managed Devices .....	11-19
11.2.3	Locations for Volume Storage .....	11-20
11.3	Sample MDMS Configurations .....	11-21

## 12 MDMS Management Operations

12.1	Managing Volumes .....	12-1
12.1.1	Volume Life Cycle .....	12-1
12.1.2	Volume States by Manual and Automatic Operations .....	12-2
12.1.2.1	Creating Volume Object Records .....	12-3
12.1.2.2	Initializing a Volume .....	12-3
12.1.2.3	Allocating a Volume .....	12-3
12.1.2.4	Holding a Volume .....	12-4
12.1.2.5	Freeing a Volume .....	12-4
12.1.2.6	Making a Volume Unavailable .....	12-4
12.1.3	Matching Volumes with Drives .....	12-4
12.1.4	Magazines for Volumes .....	12-5

12.1.5	Symbols for Volume Attributes	12-5
12.2	Managing Operations	12-6
12.2.1	Setting Up Operator Communication	12-6
12.2.1.1	Set OPCOM Classes by Node	12-6
12.2.1.2	Identify Operator Terminals	12-6
12.2.1.3	Enable Terminals for Communication	12-6
12.2.2	Activities Requiring Operator Support	12-7
12.3	Serving Clients of Managed Media	12-8
12.3.1	Maintaining a Supply of Volumes	12-8
12.3.1.1	Preparing Managed Volumes	12-8
12.3.2	Servicing a Stand Alone Drive	12-9
12.3.3	Servicing Jukeboxes	12-9
12.3.3.1	Inventory Operations	12-10
12.3.4	Managing Volume Pools	12-11
12.3.4.1	Volume Pool Authorization	12-12
12.3.4.2	Adding Volumes to a Volume Pool	12-12
12.3.4.3	Removing Volumes from a Volume Pool	12-12
12.3.4.4	Changing User Access to a Volume Pool	12-12
12.3.4.5	Deleting Volume Pools	12-12
12.3.5	Taking Volumes Out of Service	12-13
12.3.5.1	Temporary Volume Removal	12-13
12.3.5.2	Permanent Volume Removal	12-13
12.4	Rotating Volumes from Site to Site	12-13
12.4.1	Required Preparations for Volume Rotation	12-13
12.4.2	Sequence of Volume Rotation Events	12-13
12.5	Scheduled Activities	12-15
12.5.1	Logical Controlling Scheduled Activities	12-15
12.5.2	Job Names of Scheduled Activities	12-15
12.5.3	Log Files for Scheduled Activities	12-16
12.5.4	Notify Users When Volumes are Deallocated	12-16

## 13 MDMS High Level Tasks

13.1	Creating Jukeboxes, Drives, and Volumes	13-1
13.2	Deleting Jukeboxes, Drives, and Volumes	13-4
13.3	Rotating Volumes Between Sites	13-5
13.4	Servicing Jukeboxes Used for Backup Operations	13-7

## 14 Remote Devices

14.1	The RDF Installation	14-1
14.2	Configuring RDF	14-1
14.3	Using RDF with MDMS	14-2
14.3.1	Starting Up and Shutting Down RDF Software	14-2
14.3.2	The RDSHOW Procedure	14-2
14.3.3	Command Overview	14-2
14.3.4	Showing Your Allocated Remote Devices	14-2
14.3.5	Showing Available Remote Devices on the Server Node	14-3
14.3.6	Showing All Remote Devices Allocated on the RDF Client Node	14-3
14.4	Monitoring and Tuning Network Performance	14-3
14.4.1	DECnet Phase IV	14-3
14.4.2	DECnet-Plus (Phase V)	14-4
14.4.3	Changing Network Parameters	14-4

14.4.4	Changing Network Parameters for DECnet (Phase IV)	14-5
14.4.5	Changing Network Parameters for DECnet-Plus(Phase V)	14-6
14.4.6	Resource Considerations	14-6
14.4.7	Controlling RDF's Effect on the Network	14-8
14.4.8	Surviving Network Failures	14-8
14.5	Controlling Access to RDF Resources	14-9
14.5.1	Allow Specific RDF Clients Access to All Remote Devices	14-9
14.5.2	Allow Specific RDF Clients Access to a Specific Remote Device	14-9
14.5.3	Deny Specific RDF Clients Access to All Remote Devices	14-10
14.5.4	Deny Specific RDF Clients Access to a Specific Remote Device	14-10
14.6	RDserver Inactivity Timer	14-10
14.7	RDF Error Messages	14-11

## A HSM Error Messages

A.1	OpenVMS Messages	A-1
A.2	Shelf Handler Messages	A-1
A.3	Shelf Management Utility Messages	A-15

## B Sample Configuration of MDMS

B.1	Configuration Order	B-1
B.1.1	Configuration Step 1 Example - Defining Locations	B-2
B.1.2	Configuration Step 2 Example - Defining Media Type	B-2
B.1.3	Configuration Step 3 Example - Defining Domain Attributes	B-2
B.1.4	Configuration Step 4 Example - Defining MDMS Database Nodes	B-4
B.1.5	Configuration Step 5 Example - Defining a Client Node	B-5
B.1.6	Configuration Step 6 Example - Creating a Jukebox	B-5
B.1.7	Configuration Step 7 Example - Defining a Drive	B-6
B.1.8	Configuration Step 8 Example - Defining Pools	B-7
B.1.9	Configuration Step 9 Example - Defining Volumes using the /VISION qualifier	B-7

## C MDMS Messages

### D Converting SLS/MDMS V2.X to MDMS V4

D.1	Converting SLS/MDMS V2.X Symbols and Database	D-1
D.1.1	Executing the Conversion Command Procedure	D-1
D.1.2	Resolving Conflicts During the Conversion	D-2
D.2	Things to Look for After the Conversion	D-5
D.3	Using SLS/MDMS V2.x Clients With the MDMS V4 Database	D-9
D.3.1	Limited Support for SLS/MDMS V2 during Rolling Upgrade	D-9
D.3.2	Upgrading the Domain to MDMS V4	D-9
D.3.3	Reverting to SLS/MDMS V2	D-10
D.3.4	Restrictions	D-11
D.4	Convert from MDMS Version 3 to a V2.X Volume Database	D-11

---

# Preface

## Purpose of this Document

This document contains information about Hierarchical Storage Management for OpenVMS™ (HSM) and Media, Device and Management Services (MDMS) software. Use this document to define, configure, operate, and maintain your HSM and MDMS environment. Installation information is found in a separate Installation and Configuration Guide listed in the related documents table. Command information for both HSM and MDMS is found in the HSM Command Reference Guide also listed in the related documents table.

## Audience

The audience for this document includes people who apply HSM for OpenVMS™ (HSM) to solve storage management problems in their organization. The users of this document should have some knowledge of the following:

- OpenVMS™ system management
- DCL commands and utilities

## Document Structure

This document is organized in the following manner and includes the following information:

- |           |   |
|-----------|---|
| Chapter 1 | Introduction to HSM.  |
| Chapter 2 | Understanding HSM Concepts.   |
| Chapter 3 | Customizing the HSM Environment.  |
| Chapter 4 | Contains information on using HSM.  |
| Chapter 5 | Managing the HSM Environment.   |
| Chapter 6 | Operator Activities in the HSM Environment.                               |
| Chapter 7 | Solving Problems with HSM.  |
| Chapter 8 | Provides an introduction to Media, Device and Management Services (MDMS). |
| Chapter 9 | Contains information on MDMS menu Operations.                             |

Chapter 10	Contains information on Media Management.
Chapter 11	Contains information on MDMS Configuration.
Chapter 12	Contains information on MDMS Management Operations.
Chapter 13	Contains information on MDMS Tasks.
Chapter 14	Contains information on Remote Device Facility.
Appendix A	Lists HSM-specific status messages and error messages.
Appendix B	Gives a Sample Configuration of MDMS.
Appendix C	Lists MDMS-specific status messages and error messages.
Appendix D	Converting SLS/MDMS V2.x to MDMS V4

## Related Documents

The following documents are related to this documentation set or are mentioned in this manual. The lower case x in the part number indicates a variable revision letter.

<b>Document</b>	<b>Order No.</b>
<i>HSM for OpenVMS™ Installation and Configuration Guide</i>	AA-QUJ1x-TE
<i>HSM for OpenVMS™ Guide to Operations</i>	AA-PWQ3x-TE
<i>HSM for OpenVMS™ Command Reference Guide</i>	AA-R8EXx-TE
<i>HSM for OpenVMS™ Software Product Description</i>	AE-PWNTx-TE
<i>HSM Hard Copy Documentation Kit (Consists of the above HSM documents and a cover letter)</i>	QA-0NXAA-GZ
<i>OpenVMS™ System Management Utilities Reference Manual: A-L</i>	AA-PV5Px-TK
<i>OpenVMS™ DCL Dictionary: A-M</i>	AA-PV5Kx-TK
<i>OpenVMS™ DCL Dictionary: N-Z</i>	AA-PV5Lx-TK
<i>OpenVMS™ License Management Utility Manual</i>	AA-PVXUx-TK
<i>OpenVMS™ User's Manual</i>	AA-PV5Jx-TK



## Related Products

The following related products are mentioned in this documentation.

Product	Description
HSM	HSM refers to Hierarchical Storage Management for OpenVMS™ software.
MDMS	MDMS refers to Media, Device and Management Services for OpenVMS™ software.
SMF	SMF refers to Sequential Media File System for OpenVMS™ software.
SLS	SLS refers to Storage Library System for OpenVMS™ software.

## Conventions

The following conventions are used in this document.

Convention	Description
{ }	In format command descriptions, braces indicate required elements. You must include one of the elements.
[ ]	Brackets show optional elements in a command syntax. You can omit these elements if you wish to use the default response.
:	Horizontal ellipsis points indicate the omission of information from a sentence or paragraph that is not important to the topic being discussed.
. . .	Vertical ellipsis points indicate the omission of information from an example or command format. The information has been omitted because it is not important to the topic being discussed.
<b>boldface</b>	Boldface type in text indicates the first type instance of terms defined in the Glossary or in text.
<i>italic</i>	Italic type emphasizes important information, type indicates variables, indicates complete titles of manuals, and indicates parameters for system information.
Starting test . . .	This type font denotes system response, user input, and examples.
Ctrl/x	Hold down the key labeled Ctrl (Control) and the specified key simultaneously (such as Ctrl/Z).
PF1 x	The key sequence PF1 x indicates that you press and release the PF1 key, and then you press and release another key (indicated here by x).
<i>n</i>	A lowercase italic n indicates the generic use of a number. For example, 19nn indicates a four-digit number in which the last two digits are unknown.

---

<b>Convention</b>	<b>Description</b>
<i>x</i>	A lowercase italic <i>x</i> indicates the generic use of a letter. For example, <i>xxx</i> indicates any combination of three alphabetic characters.
OpenVMS™ Alpha	This term refers to the OpenVMS™ Alpha operating system.
OpenVMS™ VAX	This term refers to the OpenVMS™ VAX operating system.

---

## Determining and Reporting Problems

If you encounter a problem while using HSM, report it to Compaq™ through your usual support channels. Review the Software Product Description (SPD) and Warranty Addendum for an explanation of warranty. If you encounter a problem during the warranty period, report the problem as indicated previously or follow alternate instructions provided by Compaq for reporting SPD nonconformance problems.

---

## Introduction to HSM

This chapter provides an introduction to the general concepts of storage management in the OpenVMS™ environment and defines the role of Compaq's Hierarchical Storage Management (HSM) for OpenVMS™ software. Henceforth in this book, the term HSM is used as a replacement for Hierarchical Storage Management.

### 1.1 Storage Management in the OpenVMS Environment

Storage management is the means by which you control the devices on which the frequently accessed (active) data on your system is kept. To be useful, active data must be available for use and remain unchanged (persistent) in the event of unexpected events, such as disasters.

#### 1.1.1 Data Categories

Typically, data exists in one of three categories:

- Active-Data that you access frequently. You want virtually immediate access to this data.
- Dormant-Data that you access less frequently and are willing to wait a short time to access.
- Inactive-Data that you do not expect to access again but must keep. Generally, this type of data is kept in an archive for legal or business purposes.

On most systems, 80 percent of the I/O requests access only 20 percent of stored data. The remaining 80 percent of your data occupies expensive media (magnetic disks), but is used infrequently.

#### 1.1.2 Device Capacity, Cost, and Performance

There are many different devices on which your data can be stored, and the selection of which device best meets your storage needs depends on three factors:

- Performance
- Capacity
- Cost

The relationship among these three factors is illustrated in Figure 1-1. In general, high-performance devices have a lower capacity and higher cost than high-capacity devices. High-capacity devices trade performance for the ability to store large amounts of data.

# Introduction to HSM

## 1.1 Storage Management in the OpenVMS Environment

Figure 1-1

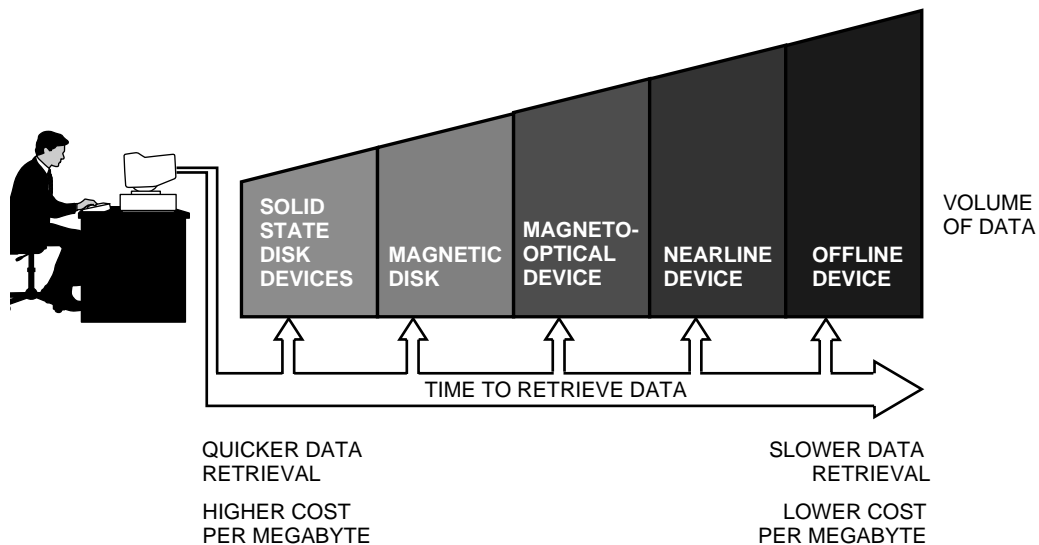

CXO-4355A-MC

### 1.1.3 Storage Management Planning

Your storage management plan should allow you to cost effectively place your data on those devices best suited to meet your cost and access requirements. This plan should include placing your active data on the most responsive devices in your system, placing your dormant data on less responsive devices, and placing your inactive data on the highest capacity devices. File activity and associated data storage are summarized in Table 1-1.

Table 1-1 File Activity and Data Storage

File Activity	Storage Type	HSM Storage Classification
Active Data that is frequently accessed and needs the fastest response time	Online Immediately available space that the system uses to store the active data. This is usually mounted magnetic disk space, but this data type could include other kinds of fast-access devices.	Primary Online storage managed through the OpenVMS™ file system. HSM moves these files to shelf storage when they have not been accessed for a predetermined time or when the storage device's remaining capacity exceeds a predefined threshold. These criteria are termed policy.
Dormant Data that is accessed less frequently and for which response time is less important.	Nearline Storage space that requires some intervention to be made available to the system, including access by robotic library devices. Access is fairly fast, but takes longer than from an online device.	Shelf Any storage device, including magnetic disk, that holds dormant data files. Data in shelf storage is termed shelved. When shelved files are accessed through the OpenVMS™ file system, HSM moves the shelved files back to primary storage.

**Table 1–1 File Activity and Data Storage**

File Activity	Storage Type	HSM Storage Classification
Inactive Data that is not expected to be accessed frequently but must be kept for archival or legal purposes.	Offline Access to this data requires human intervention for operations such as mounting tape media. Because the operator response is the significant factor, the access time is unpredictable.	

## 1.2 Storage Management with HSM

HSM software is an extension of the OpenVMS™ file system that allows you to manage your dormant data efficiently. It moves your dormant data from primary storage (where your active data is usually kept) to shelf storage. This frees the space in primary storage for use, while the dormant data remains available on lower cost media. The movement of your dormant data to shelf storage is called shelving.

To meet your storage management requirements, HSM:

- Operates as an integrated part of OpenVMS™
- Maintains accessibility and reliability of files in shelf storage and primary storage
- Supports user-initiated and system-initiated data movement between primary storage and shelf storage
- Provides caching to temporarily keep data in online storage and to decrease the impact of shelving on other operations
- Maintains access to file data within a suitable and definable time frame
- Minimizes the occurrence of volume full and user disk quota exceeded conditions

Data managed by HSM resides in one of the following states:

- **Online** - Located in primary storage (preshelved, unshelved, and never shelved data)
- **Shelved** - Located in shelf storage (shelved data)

### 1.2.1 File Headers and Location

While a file is shelved, the file's header information is maintained in primary storage. When you display the header of a shelved file, the allocated file size is shown as zero blocks, indicating that the data contents are located in shelf storage.

The directory information and file headers for your shelved data are maintained in directories on your primary storage devices. The data itself is located in shelf storage. When access is requested for the shelved data, HSM automatically returns it to primary storage. Introduction to HSM

Information on your files always can be found in your active directories, even though the actual data resides in shelf storage.

### 1.2.2 Controlling File Movement

You can control shelving in the following ways:

- You can specify which files are to be moved between primary storage and shelf storage.
- You can specify which files are not to be moved from primary storage.

## Introduction to HSM

### 1.3 HSM Storage Management Concepts

- You can set a **high water mark** on primary storage to automatically trigger shelving of your dormant data to shelf storage. A **high water mark** is a defined percentage of disk space used that, when exceeded, causes shelving to begin.
- You can set a low water mark as a space-recovered goal to limit the number of files that are moved to shelf storage. A low water mark is a defined percentage of disk space used that, when reached, causes policy-defined shelving to stop.

To implement shelving control, you use HSM **policies**. For additional information about HSM policies, see Section 1.3.3

### 1.3 HSM Storage Management Concepts

There are several key storage management concepts required to properly understand and use HSM. These concepts include:

- Shelf
- Archive class
- HSM policies and policy creation

These concepts are described in detail in Chapter 2.

#### 1.3.1 Shelf

An HSM shelf is a logical software object that relates the data in a set of online disk volumes, on which shelving is enabled, to a set of archive classes that contain the shelved data for those volumes.

#### 1.3.2 Archive Class

An archive class is a logical software object that represents a single copy of shelved data. Identical copies are written to one or more archive classes when a file is shelved. For each shelf, you can specify the number of archive classes (data copies) to have to ensure reliability of the data. Because shelved data is not backed up automatically, multiple shelf copies provide the only means of recovery if the primary copy of the shelf data is lost or destroyed. Compaq recommends you have at least two archive classes for each shelf.

#### 1.3.3 HSM Policies

An HSM policy is a defined set of parameters that controls when shelving begins and ends. HSM implements data management through HSM policies that specify responses to events. HSM policies contain HSM-specific commands to shelve or unshelve data in response to a scheduled or situational trigger event. Trigger events, used in conjunction with appropriately designed file selection criteria, work to provide enough online disk space to satisfy users' needs. For detailed information about HSM policies, see Section 2.9.3.

## 1.4 The Shelving Process

The shelving process moves files from primary storage to shelf storage. The header information for files that have been shelved is still visible to users through the OpenVMS™ directory command, even though the file's data contents are not stored online. You can modify these file headers without unshelving the files.

### 1.4.1 Starting the Shelving Process

Your control over the start of the shelving process is either explicit or implicit.

**Explicit shelving** is a process that starts in response to the DCL SHELVE command. You can issue the SHELVE command directly to the OpenVMS™ operating system, or you can execute it in an OpenVMS™ command procedure.

**Implicit shelving** is a process that occurs in response to one of the following triggers:

- Volume full, user disk quota exceeded, or high water mark exceeded requests initiated by OpenVMS™. These conditions trigger reactive policy.
- Scheduled policy execution initiated by HSM. This condition triggers preventive policy.

### 1.4.2 File Selection for Explicit Shelving

The DCL SHELVE command accepts file specifications, including wildcards, for files to process. Qualifiers to this command allow flexibility in selecting files for explicit shelving. Refer to HSM Command Reference Guide for complete information about using the SHELVE command.

### 1.4.3 File Selection for Implicit Shelving

File selection for implicit shelving is specified through HSM policy. Once you understand the file selection process, you can use Shelf Management Utility (SMU) commands to specify file selection criteria and achieve efficient use of primary storage.

#### Make Space Requests

When an application or user creates a file or extends the file, the operation may not complete because the disk volume is full or the user has exceeded the disk quota.

If shelving is enabled on the volume, this situation generates a **make space request** to HSM to free up enough disk space to satisfy the request. If responding to make space requests is enabled, HSM executes the defined policy for the volume and shelves enough files to free up the requested space. While shelving files, HSM sends an informational message to notify the user that the file access may take much longer than usual due to the shelving activity.

#### File Selection

Table 1-2 lists the stages of file selection for implicit shelving.

**Table 1–2 Process for Selecting Files According to Policy**

Stage	Event
1	HSM creates an ordered file selection list with the name and the number of allocated blocks for each file on the disk that meets the file selection criteria. This file selection list is based on the primary occupancy or quota policy defined for the online volume
2	The amount of space to be recovered is calculated based upon the volume's low water mark.
3	HSM then shelves eligible files on the file selection list until either the low water mark is reached or the list is exhausted and execution goes to step 4. Because a volume's usage is dynamic, the low water mark is checked after each successful shelve operation and is adjusted accordingly. If the low water mark is met, policy execution completes successfully and is terminated.
4	If the primary policy does not recover sufficient disk volume space, the volume is rescanned using the secondary policy to build a secondary policy candidate list, and execution returns to step 3.
5	If both primary and secondary policies have been executed and the policy goals still have not been achieved, policy execution terminates with an HSM\$_INCOMPLETE error

## Introduction to HSM

### 1.5 The Unshelving Process

#### 1.4.4 Modifying File Attributes of a Shelved File

After a file has been shelved, its header remains on the disk. You still see the file in directories, and you may view and modify the file's attributes without having to access the data in shelf storage. Any modifications you make to the shelved file's header will be in effect when the file is unshelved.

## 1.5 The Unshelving Process

The unshelving process moves files from shelf storage to primary storage. Once the file has been unshelved, you can access it normally.

### 1.5.1 Starting the Unshelving Process

Your control over the start of the unshelving process is either explicit or implicit.

**Explicit unshelving** is a process that starts in response to the DCL UNSHELVE command. You can issue the UNSHELVE command directly to the OpenVMS™ operating system, or you can execute it in an OpenVMS™ command procedure. The UNSHELVE command accepts one or more file specifications, including wildcard file specifications.

**Implicit unshelving** is a process that HSM starts in response to a file fault. A file fault is a high-priority request that occurs when a shelved file is accessed for a read, write, extend, or truncate operation.

Table 1-3 shows the process for unshelving a file.

**Table 1-3 Process for Unshelving a File**

Stage	Event
1	The user specifically requests a file to be unshelved or attempts to access a shelved file through a read, write, extend, or truncate operation (which causes a file fault). Opening a file does not generate a file fault, except for RMS indexed files, or files accessed through NFS or PATHWORKS.
2	When a file fault occurs, HSM sends an informational message to notify the user that the file access may take longer than expected because the file must be unshelved.
3	HSM searches its catalog to find where the shelved data is located. The first file copy it accesses for unshelving is the one listed in the restore archive list for the shelf.
4	The file is restored to primary storage as an unattended operation if the shelf resides on a nearline storage device. If the shelf is offline, operator intervention may be required.
5	The user process that requested access to the file waits for the file to be unshelved. If the file cannot be unshelved for any reason, an error is returned to the requester.

### 1.5.2 Process Default Unshelving Action

For each user process, you can specify a default unshelving action that controls implicit unshelving initiated by DCL commands and applications. By default, access to a shelved file causes a file fault.

However, you can specify instead that an error be returned on such access by issuing a SET PROCESS/NOAUTO\_UNSHELVE command. This is especially useful

for commands such as wildcard searches when you do not need to unshelve files to examine them for the matching string.



### **1.5.3 The Results of Unshelving a File**

When a file is unshelved, its data contents are moved into the location defined by its current directory entry in the(online) file header. If you renamed the file header while the file was shelved, the file will be unshelved into its new location or its new name. After a file has been unshelved from nearline/offline media, the copy remains on the nearline/offline media. Once unshelved, the file can be shelved again. If the file has been modified, a new shelf copy is made and the old copy is invalidated. If a file has not been modified since it was shelved originally, the previously shelved file copy remains valid and a new copy is not made.

### **1.5.4 Handling Duplicate Requests to Unshelve a File**

Subsequent requests to unshelve a given file while the file is undergoing the unshelving process are treated as duplicate requests. HSM signals that both requests have completed after the first request (the one that initiated the unshelving process) completes.

## **1.6 The Preshelving Process**

The preshelving process is a variation of the shelving process. It is similar to the shelving process in that it copies the file's data to shelf storage. It differs from the shelving process in that it allows the file to remain online and accessible even though a shelf copy is made.

A request to preshelve a file that has already been shelved or preshelved succeeds immediately. After a file is preshelved, it can still be accessed normally. If the online file is modified, the shelf copy is invalidated. Any subsequent shelve or preshelve operation causes the file to be shelved again. If the preshelved file is not modified, a subsequent shelve operation simply truncates the file's data which removes the data from primary storage.

### **Benefits of Preshelving Files**

Preshelving files allows the system to respond rapidly to make space requests. Because preshelved files already are copied to shelf storage, HSM only needs to truncate files to respond to make space requests.

## **1.7 The Unpreshelving Process**

When a shelved file is unshelved, it goes into the preshelved state. That is, the file's HSM shelf data is still valid. If the file is later shelved without being modified, no additional data copies are made and the existing shelf data is used.

However, if the file is modified, its shelf data becomes obsolete. This process is called unpreshelving, and occurs automatically if an application writes to the file. It can also be explicitly requested using the UNPRESHELVE DCL command. When a file is unpreshelved, its HSM shelf data is marked invalid, and may be subject to deletion during repack according to the updates parameter set on the associated shelf. In addition, if the shelf data is in a cache with the /NOHOLD qualifier, the cache copy of the file (and its associated catalog entry) are immediately deleted.

If a file has been unpreshelved for any reason, a subsequent shelve or preshelve operation will cause a new copy of the data to be made. An unpreshelved file is effectively identical to a file that has never been shelved.

**Introduction to HSM**  
**1.8 File Headers and Access Security**

**1.8 File Headers and Access Security**

When a file is shelved, a copy of its header is kept with the data and the original header remains in primary storage (on the disk). The header that remains in primary storage is the valid file header.

HSM maintains file access security even when the contents of the file are not present on the online disk volume, because the online file header contains file owner, protection flags, and access control lists. If you change the file protection or ownership while a file is shelved, the user who shelved the file may not be allowed to unshelve it.

**1.9 HSM File State Diagram**

Figure 1-2 illustrates the various HSM states in which a file can reside, the locations of the file’s directory, header, and data, and the operations that transition a file from one state to another.

**Figure 1–2**

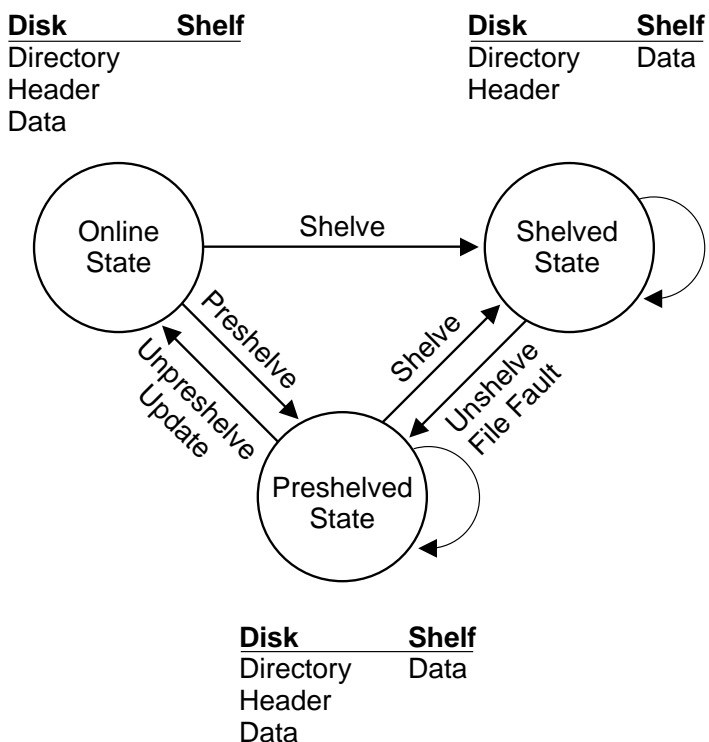

CXO-5428A-MC

**1.10 HSM Cache**

Cache is shelf storage comprised of one or more online or nearline storage devices. These devices can include magnetic and magneto-optical disks. You can use any number of devices for the cache. The cache temporarily stages shelved data between its primary online storage location and the nearline/offline media used for shelf storage. Cache is fully described in Section 2.8.

**Using a Cache Has Significant Advantages**

Using a cache greatly improves shelving performance, because the time needed to complete the operation is only as long as it takes to copy a file to another disk. The cache then can be

flushed to a nearline or offline device at a later time when the shelving operation will have less impact on system performance.

### Using Magneto-Optical Devices as Cache

Magneto-optical (MO) devices make an ideal repository for shelved data because they cost less than magnetic disks but still provide excellent response time. HSM supports MO devices as cache devices, rather than nearline devices, because the OpenVMS™ system sees them as system-mounted, Files-11 devices. This means you can define an MO device as temporary cache or as permanent (nonflushing) cache that functions as shelf storage.

## 1.10.1 HSM Operations with Cache

There are four HSM operations that involve the cache:

- Shelving
- Preshelving
- Unshelving
- Flushing

## 1.10.2 Cache in the Shelving and Preshelving Processes

Because cache is an alternate location for temporarily storing shelved files, the shelving and preshelving processes differ only slightly when cache is enabled.

The file selection process does not function differently when cache is used. Table 1-4 describes both the shelving and preshelving processes in which cache is used.

**Table 1–4 Process for Shelving and Preshelving with Cache**

Stage	Event	
1	The HSM system creates a cache file on a cache device.	
2	The file data is copied from the original file to the cache file. The cache file is closed.	
3	Subsequent events are determined by the SMU SET CACHE command's /BACKUP qualifier as follows:	
	The /BACKUP qualifier is used for the cache	The file also is copied to the nearline/offline media used for shelf storage when the file is shelved.
	The /NOBACKUP qualifier is used for the cache (default)	The file is not immediately copied to the nearline/offline media. The file is copied later, when the cache is flushed. media. The file is copied later

## 1.10.3 Unshelving from Cache

The time taken to unshelve a file from cache is almost the same as that for copying the file from one disk to another.

## Introduction to HSM

### 1.11 HSM Catalogs

#### 1.10.4 Exceeding Cache Capacity

Files that exceed the capacity of the cache are moved directly to the nearline/offline media. You can limit the amount of storage the cache can use on each online volume you designate as a cache, or you can use the entire volume for the cache.

#### 1.10.5 Flushing Cache

Flushing the cache is the process used to reclaim cache space. Any of the following events can start the cache flushing process:

- The used cache capacity meets or exceeds the defined high water mark for the cache volume.
- The cache disk experiences a volume full event.
- A periodic cache flush trigger event occurs.

Depending on how you defined the cache, the following events occur when the cache is flushed:

WHEN...	THEN...
The /BACKUP qualifier is used for the cache	The files on the cache disk are deleted, because they have already been copied to shelf storage
The /NOBACKUP qualifier is used for the cache	The files on the cache disk are copied to the nearline/offline media used for shelf storage and are then deleted.

### 1.11 HSM Catalogs

HSM catalogs contain the information HSM needs to locate and unshelve all shelved files. There is one default catalog, used for maintaining global HSM information, and a number of shelf catalogs that are related to specific shelves and volumes. If an HSM catalog suffers an unrecoverable loss, the associated shelved data may be lost. For this reason, HSM catalogs are an essential part of the HSM environment.

For information on setting up shelf catalogs, see Section 2.3.4. For information on protecting HSM catalogs from loss or corruption, see Section 5.5.

#### 1.12 HSM Archive Repacking

HSM provides the capability to repack shelf media on a per-archive class basis (optionally with selected volumes) by copying valid shelf data to new media in the same or different archive classes; deleted and obsolete files are not copied. The old media can then be reused. In addition, the catalog entries of deleted and obsolete files are deleted. The system administrator can specify a delay in deleting shelf data after an online delete, and also the number of updates a file undergoes before a shelf copy is considered obsolete. Refer to Section 5.13 for more detailed information.

## 1.13 HSM Software Modes

HSM software operates in one of two modes:

- HSM Basic mode-Provides shelving, preshelving, and unshelving functionality using simple devices, Digital Linear Tape (DLT) magazine loaders, and 4mm DAT loaders.
- HSM Plus mode-Provides shelving, preshelving, and unshelving functionality using the full suite of devices supported through Media, Device and Management Services for OpenVMS™ (MDMS), including robotically-controlled devices like TL820s and StorageTek™ silos.

Except for the media, device and management configuration and support, both modes operate identically.

---

### Note

---

**MDMS software must be installed on your system before HSM operates in Plus mode. MDMS software is available from various sources as an installable product. In addition, MDMS functionality installs as part of the Storage Library System for OpenVMS™ Version software.**

---

You choose a mode to operate when you install the HSM for OpenVMS™ software. However, you can change modes after you make the initial decision. The following restrictions apply to changing modes after installation:

- You can always change from Basic mode to Plus mode. For more information, see Section 5.22.
- You can change from Plus mode to Basic mode only if you have not written any shelved file information to a catalog in Plus mode. Once you write information to a catalog in Plus mode, you cannot change back to Basic mode.
- For a change in operating mode to have effect, you must restart HSM.

### 1.13.1 HSM Basic Mode Functions

HSM Basic mode provides the following functionality and features:

- Complete HSM functionality for small to medium customer environments that can use smaller capacity tape loaders (for example, DLT loaders), standalone tape devices, and magneto-optical devices
- A simple, integrated user interface provided completely by HSM
- Limited media management that is not integrated with other storage management products
- Support of up to 36 archive classes for data reliability
- An HSM naming convention for tape volume labels
- Local tape device support within the VMScluster™ environment: the shelf server nodes must have visibility to all tape devices (this can include TMSCP-served devices)

### 1.13.2 HSM Plus Mode Functions

HSM Plus mode provides the following functionality and features:

- Complete HSM functionality for medium to large customer environments that use large tape jukeboxes and for locations that already have the MDMS or SLS software installed
- Support for large capacity nearline devices that support multiple terabytes of data, such as the TL820 and StorageTek™ silos

## Introduction to HSM

### 1.14 Media Types for HSM Basic Mode

- Common media management with other OpenVMS™ storage management products through the MDMS software
  - Device and media management support provided through the MDMS command line and menu interfaces; this requires a more complex configuration process than for HSM Basic mode
  - Support of up to 9999 archive classes for data reliability
  - No fixed naming conventions for HSM tape volumes; the Storage Administrator controls volume names through MDMS
  - Tape device support within the cluster: the shelf server nodes do not require direct visibility to all tape devices within the cluster
  - Support for remote tape devices, those that are not directly connected within the cluster, through the Remote Device Facility™ (RDF) portion of MDMS
- Table 1-5 identifies the functionality HSM for OpenVMS™ provides and which mode provides it.

**Table 1-5 HSM Basic and Plus Functionality**

Function	Basic	Plus
OpenVMS™ Versions	6.1, 6.2	6.1, 6.2
Supported hardware platforms	VAX, Alpha	VAX, Alpha
Common media and device management with other Compaq storage products	No	Yes, through MDMS
Support for Digital Linear Tape (DLT) magazine loaders as robotically-controlled devices	Yes	Yes
Support for TL81x, TL82x	No	Yes
Maximum number of archive classes	36	9999
Requires specific HSM volume names	Yes	No
Provides support for remote devices	No	Yes
Uses a single, integrated interface for configuration and use	Yes	No

All other functions, including HSM policies and cache, are provided in both modes.

### 1.14 Media Types for HSM Basic Mode

HSM Basic mode automatically determines the media type based on the specific device(s) you define for use. Table 1-6 shows how media types map to devices for HSM Basic mode. Check the HSM Software Product Description (SPD 46.38.xx) for the latest list of supported devices.

**Table 1-6 Media Type to Device Map**

Device Type	Media Type	Magazine Loader
TA78	9-Track Magtape	No
TA79	9-Track Magtape	No

**Table 1–6 Media Type to Device Map**

<b>Device Type</b>	<b>Media Type</b>	<b>Magazine Loader</b>
TA81	9-Track Magtape	No
TA85	CompacTape III	No
TA857	CompacTape III	Yes
TA86	CompacTape III	No
TA867	CompacTape III	Yes
TA90	3480 Cartridge	No
TA90E	3480 Cartridge	No
TA91	3480 Cartridge	No
TAD85	CompacTape III	No
TAPE9	9-Track Magtape	No
TE16	9-Track Magtape	No
TF70	CompacTape II	No
TF85	CompacTape III	No
TF857	CompacTape III	Yes
TF86	CompacTape III	No
TF867	CompacTape III	Yes
TK50	CompacTape I	No
TK50S	CompacTape I	No
TK70	CompacTape II	No
TK70L	CompacTape II	No
TKZ60	3480 Cartridge	No
TLZ04	4mm DAT	No
TLZ06	4mm DAT	No
TLZ07	4mm DAT	No
TLZ6L	4mm DAT	Yes
TLZ7L	4mm DAT	Yes
TS11	9-Track Magtape	No
TSV05	9-TrackMagtape	No
TSZ05	9-TrackMagtape	No
TU45	9-TrackMagtape	No
TU70	9-TrackMagtape	No
TU72	9-TrackMagtape	No

## Introduction to HSM

### 1.14 Media Types for HSM Basic Mode

**Table 1–6 Media Type to Device Map**

Device Type	Media Type	Magazine Loader
TU77	9-TrackMagtape	No
TU78	9-TrackMagtape	No
TU80	9-TrackMagtape	No
TU81+	9-TrackMagtape	No
TZ30	CompacTape I	No
TZ30S	CompacTape I	No
TZ85	CompacTape III	No
TZ857	CompacTape III	Yes
TZ86	CompacTape III	No
TZ867	CompacTape III	Yes
TZ87	CompacTape III	No
TZ875	CompacTape III	Yes
TZ877	CompacTape III	Yes
TZ88	CompacTape IV	No
TZ885	CompacTape IV	Yes
TZ887	CompacTape IV	Yes
TZK10 6320	Cartridge	No
TZK116320	Cartridge	No

**Note**

**The media type defined for HSM Basic mode is the media type that HSM recognizes for the specified device. This is very different from the media type used for HSM Plus mode, which is the media type defined in the MDMS TAPESTART.COM file for the associated drives.**

With these device types and media types, HSM Basic mode provides formal support and identification of the device and media types. In addition, HSM Basic mode checks that devices and media are compatible to support operations within an archive class. HSM Basic mode does not formally support other devices and media types, but they might work under the following circumstances:

- The unsupported type is not a magazine loader.
- The unsupported device is not a large, multiple drive, tape jukebox; specifically, the TL81x and TL82x jukeboxes are not supported in Basic mode.
- Supported and unsupported types are not mixed within a single archive class.

Generally, a nonmagazine loader third-party tape drive with any media type may work as an 'unknown' device and media type.



## 1.15 Device Support

HSM supports the nearline and offline devices listed in the HSM Software Product Description (SPD 46.38.xx). Compaq is continually testing new devices and adding them to the list. If you have a question about a particular device, contact Compaq customer support.

---

**Note**

---

**The STK 9360 Wolfcreek Silo is supported in Plus Mode when host access from VAX and Alpha machines is configured according to the manufacturer's directions.**

---

## 1.16 Online Devices Not Supported for HSM Operations

HSM provides shelving support for most online disk devices within a cluster. However, HSM does not support the following types of online disk devices:

- Read-only devices such as CD-ROM or any disk that is software-locked or write-protected Disks that are mounted /FOREIGN
- Any disk that is a physical member of a shadow set, stripeset, or RAIDset; access to the virtual device, however, is supported
- Any device that is not flagged as a disk device in OpenVMS™ system calls

In addition, HSM does not support shelving and unshelving of local disks that are not connected to a shelf server. If you want to use shelving and unshelving with local disks, Compaq recommends you make the local disks accessible to the cluster using MSCP protocols.

## 1.17 HSM Support for Remote Operations

HSM provides limited support for remote operations. For HSM Version 3.2A, this support includes:

- Accessing shelved files on disks that are DFS, NFS, or PATHWORKS-served via applications or DCL commands. See Section 5.5.3. However, you cannot issue explicit shelving commands on served disks; this can only be done on the cluster on which the disks reside.
- Accessing shelved files from remote nodes using DCL or applications routed through DECnet (FAL). For example, a remote DCL command to TYPE a shelved file causes a file fault on the local system.
- Requesting a directory of shelved files from a remote node, although not all information is displayed. Generating make space requests and user disk quota exceeded events on an HSM-supported cluster, based on a file create or extend command issued from a remote node.

HSM does not support the following kinds of remote operations:

- Remote PRESHELVE, SHELVE, UNPRESHELVE, or UNSHELVE DCL commands with a node name in the file descriptor, or on disks that are DFS, NFS, or PATHWORKS-served.

HSM Basic mode does not support the use of remote nearline or offline tape devices, unless they are configured to appear as local devices. HSM Plus mode supports remote devices (devices that are not directly connected to the cluster) through the Remote Device Facility (RDF) portion of MDMS. For HSM Plus mode to recognize a remote device, you must have defined the remote device correctly through MDMS and you must use the /REMOTE qualifier on the SMU SET DEVICE command. For more information, see the section on “Working with RDF-served Devices” in HSM Plus Mode in the Getting Started with HSM Chapter of the HSM Installation Guide.



---

## Understanding HSM Concepts

Before running HSM in your production environment, you need to understand various definitions and concepts. For each concept, HSM provides a configuration option that you use to manage the HSM environment. This chapter presents an explanation of the HSM concepts and configuration options, structured around the following managed entities in the system:

- Facility
- Shelf
- Archive class
- Device
- Volume
- Cache
- Policy
- Schedule

This chapter also defines the relationships among the managed entities, and provides guidelines for their definition to create an optimal HSM environment. Once you understand the configuration options, you can proceed with the required configuration tasks, as described in the Getting Started with HSM Chapter of the HSM Installation Guide.

For additional information and guidelines for migrating to a more specialized environment that best meets your system requirements, see Chapter 3.

### 2.1 The HSM Environment

The HSM environment consists of the definitions you create and the relationships that exist among the definitions. The definitions described in the following sections are maintained in definition databases. The HSM environment is shown in Figure 2-1.

## Understanding HSM Concepts

### 2.2 The HSM Facility

Figure 2-1

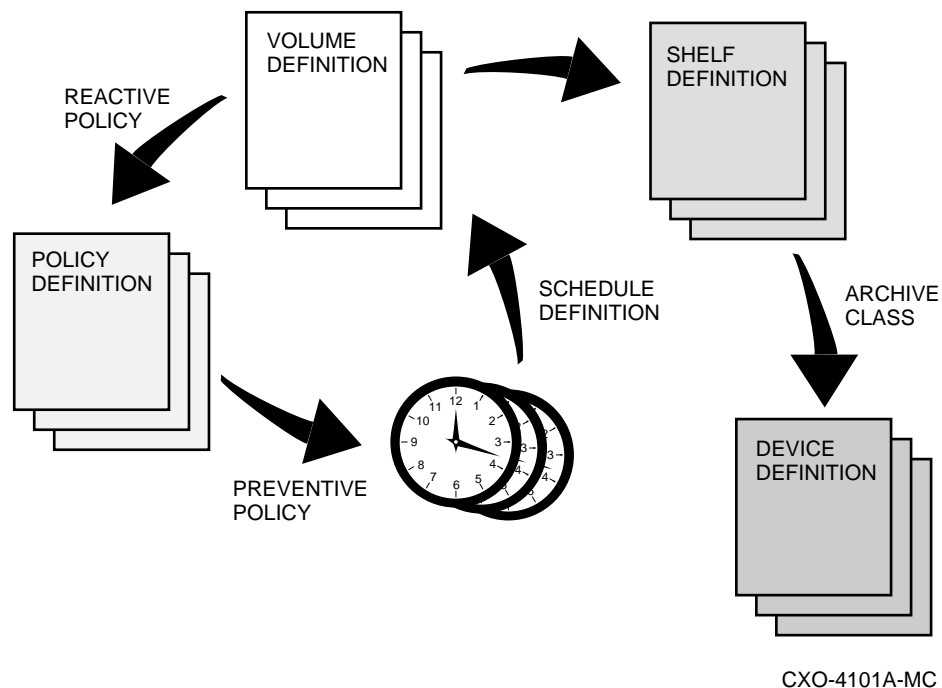

## 2.2 The HSM Facility

The HSM facility entity allows you to control HSM functions across the entire cluster. You can control the following functions at the facility level:

- HSM mode
- HSM operations
- Shelf servers
- Event logging

### 2.2.1 HSM Mode

You can specify whether HSM operates in Basic or Plus mode.

- Basic mode - Provides shelving, preshelving, and unshelving functionality using simple devices, Digital Linear Tape (DLT) magazine loaders, and 4mm DAT loaders. All interaction occurs through SMU commands.
- Plus mode - Provides shelving, preshelving, and unshelving functionality using the full suite of devices supported through Media, Device and Management Services for OpenVMS(MDMS), including robotically-controlled devices like TL820s. Interaction requires a combination of SMU commands, STORAGE commands, and forms-driven menus.

---

#### Note

**Once you change the facility to operate in Plus mode and preshelve or shelve a file (which means you have written to a catalog), you cannot go back to operating in Basic mode.**

---

### Considerations for Choosing HSM Operating Mode

When deciding whether to operate in Basic or Plus mode, consider the following:

- If you are using other storage management products that use MDMS or SLS, use HSM Plus mode. You then have one interface for media and device management across the storage management products.
- If you require support for large automated tape libraries, such as the TL820, use HSM Plus mode.
- If you do not require additional device support and are not using other products that use MDMS functionality, use HSM Basic mode.
- If you are using only magneto-optical devices and no tape devices, use Basic Mode.

### 2.2.2 HSM Operations

You can specify whether shelving or unshelving operations are enabled across the cluster as a whole. This includes operations initiated as a result of policy triggers, cache flush operations, and manually initiated HSM commands.

The shelving parameter controls shelving, preshelving and cache flush operations. The unshelving parameter controls unshelving and automatically-generated file faults.

Under normal circumstances, you should enable both shelving and unshelving across your cluster. This allows HSM to maintain desired disk usage through automatic policy operations and also allows users access to shelved data at all times.

#### Considerations for Disabling Shelving and Unshelving

You may need to disable HSM operations at certain times if they conflict with other activities (such as backups) and there are limited offline devices available. For example, if backups are performed nightly at midnight, you could set up a policy to disable shelving at that time.

When necessary, you can disable shelving and probably not cause problems with disk usage exceeding the defined goals. However, if you disable unshelving, your users and applications may experience errors accessing shelved files. You should disable unshelving only if you do not anticipate needing access to shelved data.

### 2.2.3 Shelf Servers

A shelf server is a single HSM node in a cluster that performs all operations to nearline and offline devices on behalf of all nodes in the cluster. It also coordinates clusterwide operations such as checkpointing archive classes and resetting event logs.

If the facility option `Catalog_Server` is enabled, all cache operations and catalog updates are also performed by the shelf server. By default, cache operations are performed by the requesting client node for performance reasons. Such operations are passed from other (client) nodes to the shelf server for processing. The shelf server consolidates requests from all nodes and optimizes operations to minimize tape loading and positioning, as well as to support dedicated device access.

#### Eligible Servers

Although many nodes can be authorized for shelf server operation, only one HSM node functions as the shelf server at any given time. This way, if the current shelf server node fails, operations are immediately transferred and recovered by another authorized shelf server node. You can specify up to 10 specific nodes to be authorized for shelf server operation. By default, all nodes in the cluster are authorized. The current shelf server node can be displayed using an `SMU SHOW FACILITY` command.

## Understanding HSM Concepts

### 2.2 The HSM Facility

When deciding whether to authorize a node as a shelf server, consider the following:

- In Basic mode, all specified nearline and offline devices must be accessible to all shelf server nodes. By contrast, they do not need to be accessible to client nodes.
- The shelf server undertakes the bulk of shelving operations for the cluster, so more powerful CPUs are recommended.
- To support transparent operations when a node fails, multiple shelf servers should be authorized.
- Scheduled policy execution should be run on an authorized shelf server node for optimal performance (unless a cache is defined).

Using the default authorization of all nodes is acceptable if the above conditions are met and all your nodes have similar capabilities.

If you operate a cluster with a few large systems and many satellite workstations, restricting shelf server operations to the large systems provides much better performance for all cluster users. Defining specific shelf servers is highly recommended in this case.

#### Catalog Server

HSM gives you the option of directing all HSM operations and all catalog updates through the shelf server by enabling the `Catalog_Server` option. With this option, all cache operations and catalog updates are performed by the shelf server node in a similar manner to tape operations.

There are two main reasons you may want to enable this feature:

- If you choose to protect your catalogs using RMS after-image Journaling, enabling the catalog server allows you to purchase an RMS Journaling license only for the eligible server nodes. Otherwise, it would be required on all nodes in the cluster.
- If you are using magneto-optical cache devices as a permanent shelf, the catalog server option allows you to mount the JB: platters on only the eligible shelf server nodes. This greatly speeds system reboots.

The downside of enabling the catalog server option is that caching speed is somewhat reduced due to extra intracluster communications, and possible delays in shelf server response time.

#### 2.2.4 Event Logging

HSM provides four event log files that enable you to monitor and tune the HSM environment, as well as to detect errors in HSM operation:

- `HSM$LOG:HSM$SHP_AUDIT.LOG`: The shelf handler audit log, containing information on the parameters and final status of all requests
- `HSM$LOG:HSM$PEP_AUDIT.LOG`: The policy audit log, containing information on the parameters, number of files processed, and final status of all policy executions
- `HSM$LOG:HSM$SHP_ERROR.LOG`: The shelf handler error log, containing detailed information about any serious errors encountered during request processing, including exception information
- `HSM$LOG:HSM$PEP_ERROR.LOG`: The policy error log, containing detailed information about any serious errors encountered during policy execution, including exception information

Event logging can be enabled and disabled within the following categories:

- Audit log: Records all HSM requests
- Error log: Provides information on important errors
- Exception log: Provides error information that is useful to Compaq in the error logs

Compaq recommends that you enable all logging at all times to keep track of all activity. This is especially important when you have to report a problem.

## 2.3 The Shelf

A shelf is a named entity that relates a set of online disk volumes, on which shelving is enabled, to a set of archive classes that contains the shelved file data for those disk volumes. For each shelf, you can control the following:

- Shelf copies
- Shelving operations
- Shelf catalog
- Delete save time
- Number of updates to retain

You can define any number of shelves, but any specific online disk volume can be associated with only one shelf.

### The Default Shelf (HSM\$DEFAULT\_SHELF)

HSM provides a default shelf, named HSM\$DEFAULT\_SHELF, to which all volumes are associated if no other associations are defined.

If your data reliability requirements are the same across all disk volumes, you can simply use the default shelf and specify the desired number of copies to use on that shelf. All volumes acquire the data reliability specified by the default shelf.

If your data reliability requirements differ from volume to volume, you can define multiple shelves, each of which can contain different numbers of copies for data reliability purposes. You can then relate each volume to the shelf that has the appropriate number of copies.

Compaq recommends that you specify at least two copies for each volume.

If you have a very large number of online disk volumes, Compaq recommends that you define multiple shelves, each with a separate catalog. This prevents any particular catalog from becoming so large that catalog access performance degrades. Compaq recommends that you associate between 10 and 50 online disk volumes with each shelf, depending on the amount of shelving you plan to do.

The shelf entity does not define the volumes associated with the shelf. Instead, you associate individual volume entities (see Section 2.7) with the shelf. You can associate a particular volume with exactly one shelf. If you do not define volumes explicitly, all volumes implicitly use the default shelf.

### 2.3.1 Using Multiple Shelf Copies

This section explains why you need multiple shelf copies and how to define them.

One of the most important decisions that you need to make concerns the number of copies of shelved file data that you need for data safety purposes.

## Understanding HSM Concepts

### 2.3 The Shelf

Shelved data is not normally backed up in the normal backup regimen because the OpenVMS BACKUP utility (and layered products like Storage Library System software that use BACKUP) work in the following way:

- An image backup saves only the headers of shelved files.
- An incremental backup does save the entire file, but the files that are selected for backup are those that have been recently modified and are not the files that usually are shelved.

In other words, after a file is shelved, it is likely that its data will not be backed up again. A typical backup strategy recycles the backup tapes when a certain number of more recent copies have been made. This cycle may be anywhere from a few days to several years.

However, there eventually will come a time when all of the backup tapes contain only the headers of shelved files.

Unless the tapes are never recycled, the shelved file data on the backup media will eventually be lost. As such, the easy way to enhance reliability of shelved file data is to make duplicate copies of the data by using multiple shelf copies.

#### 2.3.2 Defining Shelf Copies

Shelf copies are defined using a concept called an archive class.

An archive class is a named entity that represents a single copy of shelf data. Identical copies of the data are written to each archive class when a file is shelved.

For each shelf, you can specify the archive classes to be used for shelf copies for all volumes associated with the shelf.

The minimum recommended number of copies (archive classes) for each shelf is two.

Archive classes are represented by both an archive name and an archive identifier. Archive identifiers are used in Shelf Management Utility (SMU) commands for ease of use. HSM Basic mode supports 36 archive classes named HSM\$ARCHIVE01 to HSM\$ARCHIVE36, with associated archive identifiers of 1 to 36 respectively. HSM Plus mode supports up to 9999 archive classes, named HSM\$ARCHIVE01 through HSM\$ARCHIVE9999, with associated archive identifiers of 1 to 9999.

##### 2.3.2.1 Archive Lists and Restore Archive Lists

For each shelf, you must specify two lists of archive identifiers:

- The archive list, representing the desired number of shelf copies. Up to 10 archive identifiers can be specified in this list.
- The restore archive list, representing an ordered list of archive classes from which restore attempts are made. Up to 36 archive identifiers can be specified in this list.

The archive and restore archive lists are defined using the SMU SET SHELF command with the /ARCHIVE and /RESTORE qualifiers. See HSM Command Reference Guide for a complete description of the shelf management utility and its commands.

Restore archive classes are used for unshelving files in the order specified in the restore archive list. The first attempt to restore a file's data is made from the first archive class specified in the restore list. If this fails, an attempt is made from the next archive class, and so on. Although only 10 archive classes are supported for shelf copies, up to 36 are supported for restore, because the restore list must contain a complete list of all archive classes that have ever been used for shelving on the shelf. This enables files to be restored not only from the current list of shelf archive classes, but also from all previously-defined shelf archive classes. In this way, you can add or change archive classes for a shelf by:



Changing the archive classes in the archive list, which affects subsequent shelving operations only

Adding new archive classes to the restore list, while keeping the existing definitions in place, so that files shelved under those definitions still can be restored. Archive classes also are related to media types and devices, as discussed in Section 2.6. When a shelf is first created, the archive classes specified in the archive list are copied to the restore list if the restore list is not specified. Thereafter, the two lists must be maintained separately.

**2.3.2.2 Primary and Secondary Archive Classes**

When defining your restore archive list, it is useful to think of the first archive class in the restore list as a primary archive class and all the others as secondary archive classes. For shelving operations, all of the archive classes in the archive list receive the same amount of operations, because HSM copies data to all archive classes at the time of shelving. However, for unshelving, this is different. In most cases, HSM only needs to read from the primary archive class to restore the data. These concepts are useful when deciding how to relate your archive classes to media types and devices as described in Section 2.6.3.

**2.3.2.3 Multiple Shelf Copies**

You need to determine the appropriate number of shelf copies for your shelved file data, depending on the importance of the data being shelved.

Compaq recommends a minimum of at least two shelf copies of all data, because media can be lost or destroyed. If the data is especially critical, you can make additional copies, some of which might be taken offsite and stored in a vault. HSM provides a mechanism called checkpointing to synchronize your shelved data media and backup media so that they can be removed to an offline location together (see HSM Command Reference Guide).

Figure 2–2 illustrates the relationship between volumes and archive classes. Each disk volume has an associated archive class and restore archive class, as shown in the archive and restore archive lists. In this example, as with most cases, the archive and restore lists are identical.

**Figure 2–2**

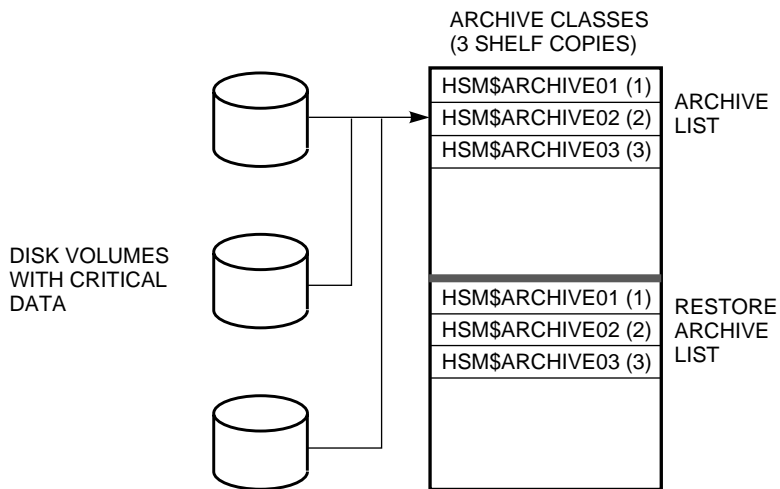

CXO-4164A-MC

## Understanding HSM Concepts

### 2.3 The Shelf

#### 2.3.3 Shelving Operations

You can control the same operations for a shelf as you can for the facility, except that the operations defined for the shelf affect only the volumes associated with the shelf.

This gives you a finer level of shelving control, which might be useful if certain classes of volumes are not regularly accessed at certain times, and you want to disable shelving activity. However, as with the facility control, it is expected that shelving and unshelving operations usually are enabled.

#### 2.3.4 Shelf Catalog

The shelf catalog contains information regarding the location of near-line and off-line data for all volumes associated with the shelf. Compaq recommends that you define a separate catalog for each shelf, but it is possible for several shelves to share a catalog, or for all shelves to use the default catalog.

Defining a separate catalog for each shelf has the following advantages:

- It restricts the impact of a temporary loss of a catalog to a known set of volumes associated with the shelf
- It reduces the size of the catalog file, allowing more flexible placement in your storage subsystem
- It increases catalog access performance, since the catalog is smaller and there are fewer records to scan
- It reduces the time for a restoration of a catalog from BACKUP tapes

As a guideline, Compaq recommends that each shelf be associated with between 10 and 50 volumes, and that each shelf has its own catalog. A shelf catalog needs to be protected with a similar level of protection as the default catalog, namely:

- The catalog should be in a shadow-set or RAID-set
- The catalog should be backed up on a regular basis.

It is also recommended that the catalog for a shelf be placed on a disk volume other than one associated with the shelf itself. In very large environments, it might be appropriate to dedicate one or more shadowed disk sets for HSM catalogs, and to disable shelving on those disks. When defining a new catalog for a shelf, or a new shelf for a volume, HSM automatically splits all associated shelving data from the old catalog, and merges it into the new catalog. See Section 5.12 for more information on this process.

#### 2.3.5 Save Time

You can specify a delete save option for shelved files that have been deleted. This option allows the specification of a delta time which keeps a file's shelved data in the HSM subsystem for this period after the file is deleted. The actual purging of deleted files (after the specified delay) is performed by the REPACK function.

#### 2.3.6 Number of Updates for Retention

This option allows the specification of a number of updates to a shelved file that will be kept in the HSM subsystem.

This option applies to files that have been updated in place, not new versions of files that have been created after an update. New versions are controlled by online disk maintenance outside the scope of HSM. The actual purging of obsolete shelf data is performed by the REPACK function.

## 2.4 HSM Basic Mode Archive Class

As previously discussed, HSM Basic mode supports 36 archive classes named HSM\$ARCHIVE01 through HSM\$ARCHIVE36, with archive identifiers of 1 to 36 respectively. You must configure archive classes by using the SMU SET ARCHIVE command to identify the archive class name. Once you have defined the archive class, you can then associate archive classes with shelves and devices using appropriate commands. From these associations, HSM Basic mode determines the appropriate media type for the archive class.

There is a separate set of tape volumes with specific labels associated with each archive class for HSM Basic mode. HSM allows limited maintenance on archive classes by allowing you to modify the shelving volume label attribute. The volume labels must be in the proper format for each archive class, as listed in Table 2-1.

Table 2-1 HSM Basic Mode Archive Class Identifier/Label Reference

**Table 2-1**

Archive Id	Volume Label	Archive Id	Volume Label	Archive Id	Volume Label
1.	HS0xxx	13	HSCxxx	25	HSOxxx
2.	HS1xxx	14	HSDxxx	26	HSPxxx
3.	HS2xxx	15	HSExxx	27	HSQxxx
4.	HS3xxx	16	HSFxxx	28	HSRxxx
5.	HS4xxx	17	HSGxxx	29	HSSxxx
6.	HS5xxx	18	HSHxxx	30	HSTxxx
7.	HS6xxx	19	HSIxxx	31	HSUxxx
8.	HS7xxx	20	HSJxxx	32	HSVxxx
9.	HS8xxx	21	HSKxxx	33	HSWxxx
10.	HS9xxx	22	HSLxxx	34	HSXxxx
11.	HSAxxx	23	HSMxxx	35	HSYxxx
12.	HSBxxx	24	HSNxxx	36	HSZxxx

For each of the 36 archive classes, the first three characters of the volume label are fixed and represent the archive class. The last three characters of the volume label (shown in Table 2-1 as xxx) represent a sequence number in the range 001 to Z99, allowing up to 3600 tape volumes per archive class. At any one time, there is one shelving volume for each archive class. This volume represents the volume on which the next shelve (write) operation is to be performed.

In the case of an error, you can explicitly change the shelving volume label for the archive class. However, if you do so, the specified volume label must adhere to the convention shown in the table, otherwise HSM cannot use it.

Manually setting the shelving volume label is not recommended. By default, HSM uses the first shelving volume label for an archive class (for example HSA001), then increments the labels automatically (HSA002, HSA003, and so forth) as the volumes become full. If you want to remove the current shelving volume and go to the next one, use the CHECKPOINT command rather than resetting the label manually.

## 2.5 HSM Plus Mode Archive Class

As previously discussed, HSM Plus mode supports up to 9999 archive classes named HSM\$ARCHIVE01 through HSM\$ARCHIVE9999, with archive identifiers of 1 to 9999 respectively.

You must configure archive classes by using the SMU SET ARCHIVE command to identify the archive class, media type, and optionally density. When specifying media type and density, they must exactly match the corresponding media type and density defined in the MDMS TAPE-START.COM file.

Once you have defined the archive class, you can then associate archive classes with shelves and devices using appropriate commands.

Unlike HSM Basic mode, HSM Plus mode does not require special naming conventions for volumes, because MDMS chooses the volumes for HSM Plus mode to use.

## 2.6 Device

When setting up your HSM environment, you need to consider which nearline and offline devices you want to use. When setting up a device for HSM, you can control:

- Whether the device is shared or dedicated
- Whether operations are enabled for the device
- Which archive classes use the device

---

### Note

---

**To use magneto-optical devices for shelf storage, you define these devices as caches, not as shelving devices. For more information, see Section 2.8.5.**

---

### Default Device (HSM\$DEFAULT\_DEVICE)

HSM provides a default device record that has the following attributes:

- Device is shared
- Device is enabled for HSM use
- No archive class is associated with the device

These defaults are applied if you specify a device for HSM without identifying these attributes. Once the device is defined, you can modify the attributes for that device. You also can modify the default device record attributes if you find that you are typically using a different set of attributes for your devices.

### 2.6.1 Sharing and Dedicating Devices

For HSM use, you can specify a nearline or offline device to be used for dedicated or shared usage.

When a device is dedicated, HSM does not release it to other applications and keeps the current volume mounted until the drive is needed for another HSM volume.

When a device is shared, HSM releases the device, and dismounts and unloads the associated media within one minute of inactivity on the device. The media is unloaded for security reasons.

When thinking about devices, you should consider the trade-offs involved in dedicating devices to HSM.

### Advantages of Dedicating a Device

Dedicated devices have the following advantages:

- The device is always available for HSM use and pending HSM operations should not be blocked by other potentially long-running applications.
- Slow operations like tape loading and positioning are minimized, as is operator intervention.
- Response time for shelving and unshelving operations is generally better.

### Disadvantages of Dedicating a Device

Dedicated devices have the following disadvantages:

- The device is not available for other purposes while the device is dedicated.
- Additional nearline/offline devices may be needed for non-HSM operations.

### Device Mixed Mode Operations

It is possible to operate in a mixed mode, whereby the device is sometimes shared and sometimes dedicated. For example, you can set up a scheduled policy with a script that toggles between the two modes at specified times. A useful application of this would be to dedicate devices to HSM during normal working hours and at policy execution time, but switch to shared devices during the backup cycle.

## 2.6.2 Device Operations

For each device, you can specify which operations are enabled. The choices are shelving and unshelving. By default, both operations are enabled when a device is specified.

When operating in Plus mode it is recommended that all devices are defined for both shelving and unshelving as MDMS, not HSM, actually chooses the optimal device. Restricting operations sometimes leads to conflicts between HSM and MDMS.

When you are using multiple devices in Basic mode, you can optimize operations by specifying that only shelving or only unshelving is enabled on the device. This will effectively guide those operations to the enabled device rather than allowing many load/unload operations as the requests come in. For example, if you are using two devices, you might specify that one is used for shelving and the other is used for unshelving. A special override allows unshelving on a shelving device if the currently mounted media contains the requested file, which is common if the file is unshelved shortly after it is shelved.

If you specify only a single device for HSM, it must support both operations for correct usage.

### Media Type Compatibility

When setting up a device for HSM use, you define a media type by relating the device to one or more archive classes whose media type and density are compatible with the device.

This does not mean that shelving devices have to be identical for any archive class. For example, a TK50 device might be specified for shelving and a TK70 device be specified for unshelving. This is valid because a TK70 can read a TK50 written cartridge, but not vice versa.

However, if you do use compatible but not identical media types, you must control the operations on the devices so the tapes are always written in a compatible format. The media must be written in the format readable by both device types (in this case TK50), and all media must be in the same format for a specified archive class.

## Understanding HSM Concepts

### 2.6 Device

#### 2.6.3 Devices and Archive Classes

Nearline and offline devices are associated with archive classes that relate to shelves. When specifying archive classes for shelf copies, you must consider the media type on which you want these copies to reside. Each archive class uses exactly one media type, so that all data written to a specific archive class uses compatible media. Be aware that multiple archive classes can use the same media type.

You establish the relationship between archive classes, devices, and media type by using the SMU SET DEVICE command and specifying an archive list. Remember that for HSM Plus mode, you also use the media type definitions in the MDMS TAPESTART.COM file to encapsulate the media type and drives relationship. Regardless of how archive classes and shelves relate, the relationship between archive classes and devices is not one-to-one. This means that:

- A single device (for example a TA90 tape drive) can support multiple archive classes of the same media type.
- Operations on different shelves and archive classes can share devices.
- An archive class can use one or more compatible tape drives.
- Different volumes from within an archive class can be mounted simultaneously on separate compatible drives.

Figure 2–3 shows the archive class/media type/device relationship for three archive classes and the associated TA90 and TK50 tape devices. As shown in the figure, the two TA90 devices can each archive data belonging to their common archive classes, but the TK50 device can only operate with a single archive class.

**Figure 2–3**

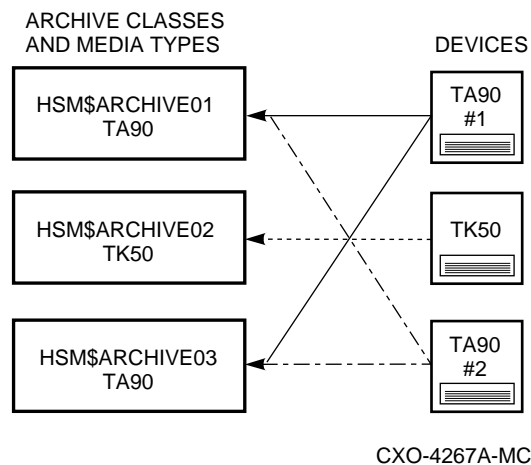

Ideally, an HSM configuration uses identical media types for all archive classes, allowing the maximum sharing of devices, because each device could support all archive classes. However, this is not always possible or desirable. For example, you may want to define a primary archive class that uses a robot-controlled nearline device and some secondary archive classes that use human-operated 9-track magnetic tape devices.

### Associating Devices with Archive Classes

When selecting the devices associated with an archive class, you should consider such aspects as:

- Device speed
- Automatic or human intervention for loading and unloading
- Device cost

A robot-controlled nearline device is recommended for primary archive classes, because users will be able to access shelved files without human intervention, on a 24 - hour basis. The need for such devices is less on secondary archive classes, especially if an online cache is used (see Section 2.8).

### 2.6.4 Magazine Loaders for HSM Basic Mode

HSM Basic mode supports certain tape magazine loaders as nearline devices that can be associated with archive classes. A magazine is a stacker containing one or more tape volumes that can be loaded into a single drive. The following magazine loaders are fully supported with random-access loading and unloading of tape volumes:

- TA857, TF857, TZ857
- TA867, TF867, TZ867
- TLZ6L, TLZ7L
- TZ875, TZ877
- TZ885, TZ887

HSM Basic mode supports multiple magazines, with multiple volumes per magazine. In addition, volumes for multiple archive classes may reside in a single magazine. However, there are a few restrictions that must be observed for HSM:

- All volumes placed in magazines must be initialized prior to use with the OpenVMS INITIALIZE command. Volume labels are the same as for nonmagazine loaders and must conform to the conventions shown in Table 2-1. In addition, it is vital that all tape volumes have unique labels. HSM does not support multiple volumes with the same label, which can result in the loss of access to shelved data.
- An archive class must be specified for loader operations, or nonloader operations exclusively, and must be assigned to appropriate devices. You cannot mix loader and nonloader tape operations for the same archive class at the same time. However, you can migrate an archive class from nonloader to loader (or vice versa) as long as it has the same media type.

#### Magazine Initialization (Basic Mode only)

At initialization time, and when a new magazine is loaded, HSM performs an inventory on the magazine. Each volume in the magazine is loaded and mounted, and its label is noted. This information is stored in a device database, which has multiple magazine entries. This operation takes 20 to 30 minutes, during which time the drive cannot be used.

Compaq highly recommends that volumes are not shuffled around in a magazine or moved to different magazines after initial configuration, because this will cause HSM to perform another inventory on the magazine. If the shelf handler discovers an inventory error, it loads all volumes and retakes inventory on the magazine. A new magazine entry is entered into the database. In addition, all existing magazine entries containing any of the volumes are then invalidated.

## Understanding HSM Concepts

### 2.6 Device

Under ideal circumstances, inventory on any magazine should have to be done only once, regardless of system crashes and other disruptions.

Once inventory is taken, the shelf handler uses random- access load and unload commands to load the appropriate volumes into the drive. The device database is updated on all load and unload operations, so that the state of the drive and magazine is known at all times, even after system disruptions.

If an inventory detects an illegal configuration with duplicate tape labels, the shelf handler prints an OPCOM message to the operator and will not use the magazine.

#### Robot Name (Basic Mode only)

When defining a device as a magazine loader, it is necessary to specify a robot name to be associated with the device. The robot name depends on the controller to which the tape device is connected, as follows:

- A directly-connected SCSI device- such a device will have a name in the format alloc\$MKxnn0:. The associated robot name is alloc\$GKxnn1: or alloc\$MKxnn1:. For example, for device \$1\$MKB100:, the associated robot name is \$1\$GKB101: or \$1\$MKB101:.
- A directly-connected DSA device, such as a TF867-in this case, the robot name is identical to the device name, but must still be specified.
- A device connected to an MSCP-controller, such as an HSC, HSJ or HSD - in this case, the robot name is the name of the controller's command disk. An example might be \$1\$DUA812:.

The robot name should include the allocation class if there is one.

---

#### Note

##### Upgrading from HSM V1.x

**If you are upgrading from HSM V1.x, please note that the robot name replaces the HSM\$device\_name logical defined for MSCP-controllers. The robot name must be specified for all Basic mode magazine loaders after installing this version before robotic operations will occur. This applies to devices connected to all types of controller.**

---

### 2.6.5 Compatible Media for HSM Basic Mode

HSM Basic mode makes a first-level attempt to ensure that tape device configurations and loading are directed to compatible media. For this level, HSM ensures that the media type is physically capable of being loaded into the specified device, and that the media can support the operation. HSM also verifies that media contained in magazine loaders are not requested for nonloader drives and vice versa.

Table 2-2 lists the compatible media types HSM supports. HSM also supports unknown media types, but does not check them for compatibility. It is therefore possible to specify different types of tape devices with "Unknown" media type into an impractical configuration. If using such drives and media, you must ensure that the configuration is practical.

**Table 2-2 Compatible Media Types**

Devices That Write...	Can_Read...	Comments
9-Track Magtape	9-Track Magtape	No density checking is performed.



**Table 2–2 Compatible Media Types**

Devices That Write...	Can_Read...	Comments
3480 Cartridge	3480 Cartridge	No compression checking is performed.
DigitalTape I	CompacTape I	TK50 Format.
DigitalTape II	CompacTape I, II	TK70 Format.
DigitalTape III	CompacTape I, II, III	TK8x
DigitalTape IV	CompacTape I, II, III, IV	Format-Number of tracks not checked.
4mmDAT	4mmDAT	Differences in length not checked.
Unknown	Any	No checking is performed.

### 2.6.6 Automated Loaders and HSM Plus Mode

HSM Plus mode supports automated loaders according to the MDMS functionality and requirements. In general, MDMS recognizes automated loaders and the volumes contained therein only by process of how you configure the information in TAPESTART.COM and through the STOR-AGE commands. For more information, see the Getting Started with HSM Chapter of the HSM Installation and Configuration Guide.

## 2.7 Volume

HSM allows you to customize HSM activity on a per-volume basis. By default, there is only one HSM volume entity, HSM\$DEFAULT\_VOLUME, which is used as the basis for HSM activity for all volumes in the cluster. You can add any number of specific volumes, each relating to a single online disk volume, as you want. Any disk volumes not associated with a specific volume entry are implicitly associated with the default volume.

### Default Volume Attributes

The default volume is preconfigured with a default set of attributes. You can modify any or all of the attributes on the default volume, which are then applied to all volumes associated with the default volume. The attributes of the default volume also are used as a template for specific volume entities.

With the volume entity, you can specify the following attributes:

- Shelf
- Shelving operations
- Volume policy
- High water mark
- Files excluded from shelving

### 2.7.1 Shelf

The shelf attribute relates the disk volume definition to a single shelf definition. The shelf must be set up before associating a volume with it. For information on setting up the shelf, see Section 2.3 By default, all volumes use the default shelf HSM\$DEFAULT\_SHELF.

## Understanding HSM Concepts

### 2.7 Volume

#### 2.7.2 Shelving Operations

HSM provides volume definition options that allow you to control shelving operations on the online disk volume for which the volume definition applies. If no volume definition is found, HSM uses the HSM\$DEFAULT\_VOLUME definition.

The following operations can be enabled on a per-volume basis:

- High water mark-The ability to trigger the specified occupancy policy if disk usage exceeds the specified high water mark.
- Occupancy-The ability to trigger the specified occupancy policy if an application attempts to exceed the volume capacity.
- Exceeded quota-The ability to trigger the specified occupancy policy if an application attempts to exceed a file owner's quota.
- Shelving-Any shelving or preshelving operation, including those initiated by policy and manual operations.
- Unshelving-Any unshelving operation, including those initiated by file access and manual operations.

By default, implicit operations (high water mark, occupancy, and quota) are disabled and explicit operations (shelve and unshelve) are enabled on the volume.

#### 2.7.3 Volume Policy

The volume policy parameters identify the policy definitions used to shelve files when a critical need for space on the disk is encountered. This policy implementation reacts to critical situations in which additional primary storage space is needed.

A reactive policy is implemented with a disk volume definition. Reactive policy determines how to react to high water mark, volume occupancy exceeded, and user disk quota exceeded events. In these instances, some event takes place that requires primary storage space be made available.

HSM takes action to make the space available only when the event takes place. A reactive policy execution can be disabled by specifying that no policy is desired for the specified event.

#### 2.7.4 High Water Mark

You can specify a percentage of the volume's capacity that will be used as a trigger for running the occupancy policy on the volume. See Section 2.9 for more details.

#### 2.7.5 Files Excluded from Shelving

There are two types of files that you should give special attention to when considering their disposition in an HSM environment:

- Files marked contiguous
- Files placed at specific logical block numbers

These files have special attributes when they are created that may not be possible to recreate when the files are shelved and later unshelved.

### Contiguous Files

Files that are marked contiguous must occupy contiguous logical block numbers on the disk. When such a file is shelved, its storage is released. During unshelving operations, this type of file must be restored contiguously. If this is not possible because the available space on the disk is fragmented, the unshelve operation fails. To avoid this problem, you should specify that files marked contiguous are ineligible for shelving. By default, files marked contiguous are not shelvable.

### Placed Files

Placed files are assigned specific logical block numbers on the disk volume when created. When such a file is shelved and later restored, it is virtually guaranteed that they cannot be restored to the originally assigned logical blocks. If the file must be assigned to the assigned logical blocks, it should not be shelved. One way of disabling such shelving is to disable shelving on all placed files on the volume. Another way is to mark the file as not shelvable using an OpenVMS command.

By default, HSM allows shelving on placed files. To prevent this behavior, you need to specifically disable shelving of placed files for the volume.

## 2.8 Cache Usage

The cache is storage comprised of one or more online disk storage devices or magneto-optical devices. You can use cache volumes for one of two purposes:

- As a temporary online staging area to speed shelving operations. A cache used for this purpose is set up with a limited block size and a regular flush interval. Shelving operations are directed initially to the cache and complete in a similar amount of time as a normal file copy. At a later time, the cache is flushed to the archive classes defined for nearline or offline storage, and files in the cache are deleted.
- As an alternative shelf, using magneto-optical devices or excess online disk devices. A cache used for this purposes usually uses the entire device for caching, but does not flush the files to nearline or offline storage. Optionally, additional copies can be made to nearline or offline archive classes at shelving time, using the /BACKUP qualifier. When using a cache as a permanent shelf, you cannot also use it for staging.

### 2.8.1 Advantages and Disadvantages of Using a Cache

By using a cache, you gain speed for shelving operations by dedicating additional online storage for the HSM system. With online cache, a shelving operation can complete in the time it takes for the files to be copied to another disk.

The archive/backup system is not needed immediately. However, you lose online storage capacity otherwise dedicated to applications and users. This is the trade-off to consider when using online cache. If your system includes some older, slower online drives, then online cache provides multilevel hierarchical storage management.

All cache devices must be system-mounted and accessible to all nodes in the cluster except when the Catalog Server facility option is enabled. In this case, the cache devices need only be system-mounted and accessible to all designated shelf server nodes.

### 2.8.2 Cache Flushing

Another major advantage to using online cache is that flush operations to nearline/offline storage can be performed at regular intervals. These flush operations are optimized to reduce the amount of tape reloading and positioning compared to individual shelve operations directly to tape. This is especially true when multiple archive classes are specified, and the archive classes are sharing devices.

## Understanding HSM Concepts

### 2.8 Cache Usage

#### 2.8.3 Cache Attributes

You can specify the following attributes for each online disk volume supporting the cache:

- Timing of shelf copies
- Block size
- High water mark
- Flush interval
- Flush delay
- Delete and modify file action

##### 2.8.3.1 Timing of Shelf Copies

You can specify that data copies to the shelf archive classes be performed at one of two times:

- When the file is shelved
- When the cache is flushed

By default, the shelf copies are made when the cache is flushed, and this is the recommended mode of operation when using the cache as a staging area. With this configuration, operations to and from the cache are fast, taking about as much time as a normal disk copy.

##### Permanent Cache

If you are using the cache as a permanent shelf instead of a staging area (for example, using a magneto-optical device), there is no cache flushing, so any shelf copies need to be made at shelving time. When the shelf copies are made at flush time, the shelving process is not complete until all shelf copies of a file have been made to the shelf archive classes.

##### 2.8.3.2 Cache Block Size

You can specify the maximum amount of space on the online volume to be used for HSM caching. HSM never exceeds this amount. If shelving a file would exceed this amount, it is diverted to another cache device that can hold the data, or the file is copied directly to the shelf archive classes.

To allow an unlimited amount of space on a disk to be used for caching, you can enter a block size of zero, which defaults to the device capacity. This is useful when using magneto-optical devices as a permanent shelf.

If you do not specify a block size, HSM uses a default value of 50,000 blocks.

##### 2.8.3.3 High Water Mark

You can specify that a cache flush be triggered when a specified percentage of the cache block size is exceeded. In this way, you should never get into a situation where the block size is exceeded. By default, cache flushing begins when 80 percent of the block size is used.

##### 2.8.3.4 Cache Flush Interval

In addition to high water mark cache flushing, you also can flush the cache at regular intervals. This allows you to restrict all nearline or offline shelving operations to occur at a specific time of day, ideally at times other than during the backup cycle. By default, the cache is flushed every 6 hours.

##### 2.8.3.5 Cache Flush Delay

In conjunction with the flush interval, you can specify a delay to start the first cache flush. Thereafter, the delay is used in conjunction with the interval to flush at regularly timed intervals.

### 2.8.3.6 Delete and Modify File Action

You can specify how the cache reacts when an online file that is shelved to the cache is deleted, or if it is unshelved and modified. You can choose that the file remains in the cache when these events occur, or is deleted together with its associated catalog entries. The former action is safer in that the cache copy can be used to recover the file data if it is erroneously deleted or modified. However, it also means that extraneous copies of obsolete data are retained in the cache, which may eventually be flushed to tape. When migrated to tape, shelf options such as delete save time and number of updates can be used to purge any obsolete data during a repack operation.

### 2.8.4 Optimizing Cache Usage

The following guidelines on configuring the cache will provide optimal HSM performance for all users on the cluster:

- Set your cache size to be between 100 percent and 150 percent of the typical amount of data shelved within the flush interval. For example, if about 100,000 blocks of data are shelved daily, and your flush interval is 24 hours, then set your cache size at 150,000 blocks. You can then expect that no shelving operations to the shelf archive classes will be needed until the cache is flushed.
- Distribute the total cache size across several online volumes, with different sizes for each volume. This enables you to use 'low usage' disk volumes effectively and provides an effective way to equalize the usage across all your disk volumes.
- Schedule the cache flush so that it happens when your nearline and offline devices are idle. HSM optimizes all operations during the cache flush to minimize tape loading and positioning.

By using a cache effectively, you are using HSM in the most efficient way and providing the best overall service to the system users.

### 2.8.5 Using Magneto-Optical Devices

Magneto-optical (MO) devices make an ideal repository for shelved file data, because their cost is significantly lower than magnetic disks but their response time is good. HSM supports magneto-optical as cache devices only; they cannot be defined like tape devices to support archive classes.

To configure a magneto-optical device, you should define a label and mount the volume as a normal Files-11 disk. The volume label should not be an HSM label in the HSxxxx format, but should be of the system administrator's choosing. If you are using a magneto-optical robot loader with multiple platters, each platter that you want HSM to use should:

- Be system-mounted as a Files-11 device with a specific 'device name'
- Be defined in an SMU SET CACHE command

You can define the magneto-optical devices as either a cache staging area, or as a permanent shelf for fast response time using the /BACKUP attribute of the SET CACHE command. For more information and an example, see the SMU SET CACHE command in HSM Command Reference Guide.

## 2.9 Policy

HSM policy is at the center of the shelving process. The policy options you define establish the conditions that start the shelving process and determine the amount of primary storage available when shelving operations end.

## Understanding HSM Concepts

### 2.9 Policy

#### 2.9.1 HSM Policy Options

HSM policies are implemented through the available file selection options. These options allow you to define how HSM will implement storage management on your system. The HSM policy file selection options which may be set are:

- Trigger events
- File selection criteria
- Goal

Figure 2-4 shows the general sequence of HSM policy operations. Once a reactive or preventative policy is established, system operations continue normally until a trigger event occurs. The trigger event activates HSM policy and files are shelved in accordance with the file selection criteria until the policy goal is reached.

#### 2.9.2 Trigger Events

The trigger is an event that causes the shelving process to begin moving files to shelf storage. These events activate HSM policies that fall into two general categories, based on the kind of trigger used:

- **Preventive**-Preventive policy criteria include scheduled movement of files between primary and shelf storage using such determinants as file event dates and file size.
- **Reactive**-Reactive policy criteria include reactions to system events, such as exceeding the amount of space available on a disk volume (volume full), exceeding a high water mark (the amount of space defined for use on a disk volume), or exceeding a user's disk quota.

When you install HSM, you get a set of default policy definitions. You can obtain the most value from HSM by modifying the default preventive and reactive policies according to the exact types and usage of data in your installation and the specific archive storage devices that are installed.

Figure 2-4

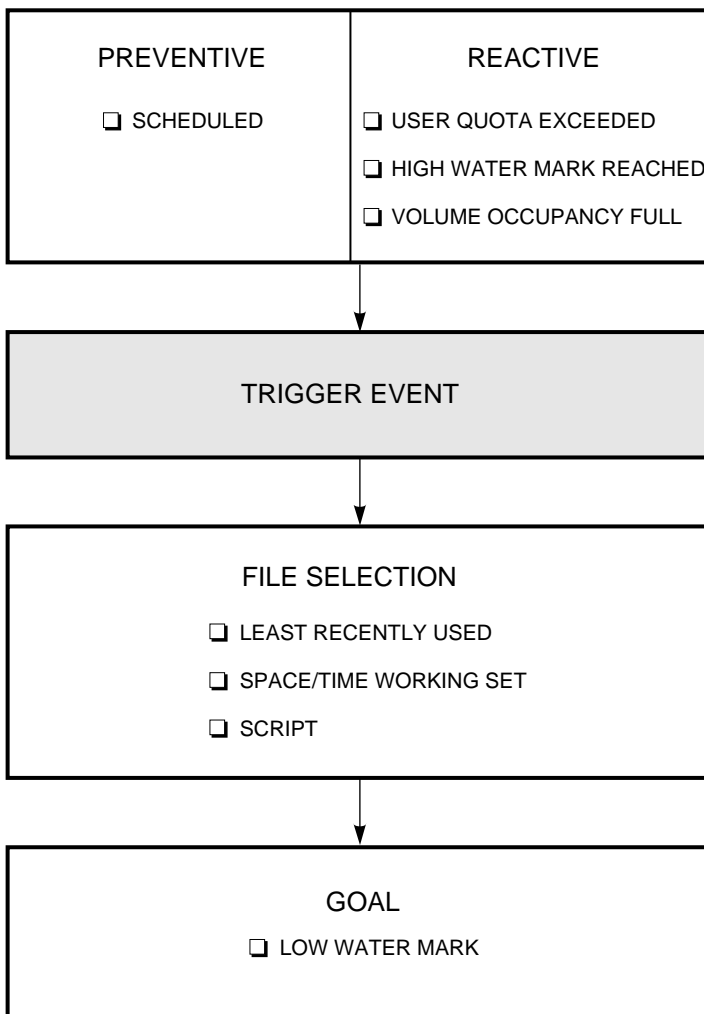

CXO-4097A-MC

### 2.9.2.1 Scheduled Trigger

A scheduled trigger is generated according to a schedule definition. You define a schedule that specifies a time interval on which HSM initiates the shelving process. This trigger, used with appropriate file selection criteria, makes sure enough online capacity is available to meet a steady demand for storage space.

### 2.9.2.2 User Disk Quota Exceeded Trigger

The user disk quota exceeded trigger is an event that occurs when a process requests additional online storage space that would force it to exceed the allowable permanent disk quota. The shelving process selects to shelve files owned by the owner of the file being created or extended. This trigger, used in conjunction with an appropriately designed file selection criteria, provides enough online disk space to satisfy the request. This trigger uses the quota policy defined for the volume. The shelving process initiated with the disk quota exceeded trigger shelves files owned by the owner of the file being created or extended. This trigger is independent of the owner of the process that extends the file; only the file ownership is significant.

## Understanding HSM Concepts

### 2.9 Policy

For example, if user A creates a file, and user B extends the file beyond user A's disk file quota, user A's files will be shelved.

#### 2.9.2.3 High Water Mark Trigger

The high water mark trigger is an event that occurs when the amount of online disk storage space used exceeds a defined percentage of capacity. The HSM system regularly polls all online disk devices and compares the used storage with a defined value. This trigger, used with appropriately designed file selection criteria, ensures enough online capacity is available to meet a steady demand of storage space. This trigger uses the occupancy policies defined for the volume.

#### 2.9.2.4 Volume Full Trigger

The volume full trigger is an event that occurs when the file system encounters a request for more space than is currently available on the disk volume. This trigger, used in conjunction with an appropriately designed file selection criteria, provides enough online disk space to satisfy the request. This trigger uses the occupancy policies defined for the volume. The shelving policy implemented with the volume full trigger shelves any files on the disk volume that meet the defined file selection criteria.

### 2.9.3 File Selection Criteria

The file selection criteria determine the best files to be shelved in response to the need for shelving. You define the file selection criteria depending on your need to create and access data.

Examples of file selection criteria include:

- Least recently used (LRU)-Files are moved to shelf storage based on the time that has elapsed since they were accessed, created, modified, or backed up.
- Space time working set (STWS)-Files are moved to shelf storage based on an algorithm that takes into account the file's size and the defined LRU criteria.
- By running a script-The file is shelved during execution of a user-defined OpenVMS command procedure.

#### Selecting Files Based on Time

The first consideration for defining file selection criteria involves selecting files that have been accessed or that have expired within a certain time frame. There are four file dates from which to choose:

- Expiration (default)
- Creation
- Modification
- Backup

OpenVMS does not support a last access date as such. However, you can set up policies using an effective last access date by:

- Setting volume retention time on each volume
- Using the expiration date as the selection criteria for HSM policies

Using the expiration date coupled with volume retention time is the recommended and default configuration for HSM policies. This ensures that files are shelved only if they have not been accessed for read or write operations within a certain time frame. Use of the other date fields, while supported, may result in some frequently-accessed files being shelved.

For more information, see Section 3.2.5.



Candidate file ordering is then achieved by using one of the following algorithms which use the specified date:

- Least recently used (LRU)
- Space time working set (STWS)

### Least Recently Used

The least recently used policy selects files based on the selected date option and the last time the date changed. It creates a listing of files ranked from the greatest time since last accessed to the smallest time since last accessed.

### Space Time Working Set

The space time working set policy selects files based on a combination of the file size and the LRU ranking. STWS is the product of the file size and the time since last access. Candidates are ordered from the greatest to the least ranking value returned for all files. Larger files tend to be ranked higher than smaller files.

### Script

The script is a DCL command file containing `SHELVE`, `PRESHELVE`, or `UNSHELVE` commands. Other DCL commands also may be included.

### Primary and Secondary Policy

Each HSM policy supports both a primary and a secondary policy definition. The primary policy definition is always executed. If the volume's lowwater mark is reached after the primary policy execution completes, the secondary policy definition is not executed. If the volume's lowwater mark is not reached after the primary policy execution completes, the secondary policy definition may be executed. This second execution occurs only when either one or both policy definitions is a user-defined script.

Refer to the `SMU SET POLICY` command description in *HSM Command Reference Guide* for a detailed description of primary and secondary policy.

### File Exclusion Criteria

When using the predefined file selection algorithms `STWS` and `LRU`, you can specifically exclude files that may be selected based on a relative or absolute date. For example, you may want to always exclude files that have been accessed within the last 60 days. There are three fields from which you can choose to exclude files:

- **Elapsed time** - Specified as a delta-time, this is a relative period of time that applies to the selected date, which exclude files from being shelved during the policy execution. For example, if you specify the expiration date with volume retention, and an elapsed time of 180 days, then files accessed within the last 180 days are excluded from shelving. This is the default value.
- **Before time** - Specified as an absolute time, this restricts shelving of files to those accessed before a certain date. For example, if you specify modification date and a before time of 01-Jan-1999, then only files that had been modified before 01-Jan-1999 will be eligible for shelving.
- **Since time** - Specified as an absolute time, this restricts shelving of files to those accessed after a certain date. For example, if you specify creation date and a since time of 30-Jun-1998, then only files that were created after 30-Jun-1998 are eligible for shelving.

## Understanding HSM Concepts

### 2.9 Policy

Specifying a relative elapsed time is mutually exclusive of defining absolute before and/or since times. The time fields apply to only the predefined STWS and LRU algorithms. They do not apply to script files.

#### Script Files

A script file is a user-written command procedure that can be executed instead of the pre-defined algorithms supplied with HSM. When the script file is executed, parameter P1 contains the name of the volume on which the policy was triggered. This can be used to perform custom shelving operations on the specified volume. When a script is defined, the file selection criteria, file exclusion criteria and goal defined for the policy are not applied. The script file executes to completion exactly as written in all cases.

#### 2.9.4 Policy Goal

The goal is the condition that causes the shelving process to stop. There are two ways to reach the shelving goal:

- Shelve enough files to recover the specified percentage of the disk volume as defined by the low water mark. Recovering sufficient space to reach the low water mark is adequate to continue using the disk volume.
- Shelve all files that meet the policy but do not reach the specified percentage of recovered capacity. This condition could indicate your file selection criteria is not broad enough.

The low water mark is checked at the completion of, but not during, a script execution. The secondary policy is run if the primary policy did not reach the low water mark.

#### 2.9.5 Make Space Requests and Policy

##### Make Space Requests

When an application or user creates or extends a file, the operation may not complete because the disk volume is full or the user has exceeded his disk quota. If shelving is enabled on the volume, this situation generates a make space request to HSM to free up enough disk space to satisfy the request. If responding to make space requests is enabled, HSM executes the defined policy for the volume and shelves enough files to free up the requested space. While shelving files, HSM sends an informational message to notify the user that the file access may take much longer than usual due to the shelving activity. After the requested disk space is made available, the create or extend operation continues normally. If for any reason the make space operation fails, the user's original request to create or extend a file fails with one of the following two error messages:

```
%SYSTEM-E-DEVICEFUL, device full - allocation failure
```

or

```
%SYSTEM-E-EXDISKQUOTA, exceeded disk quota
```

Because make space operations may take a significant amount of time, and because you may prefer certain applications to issue an immediate error rather than wait for the request to complete, you can disable make space requests on a per-policy, per-volume, or per-process basis.

##### Make Space Policy

Make space requests start a policy execution for the volume. The user process that requested the make space allocation is allowed to continue as soon as the amount of space allocation that was requested is satisfied. However, in anticipation of future make space requests, the policy continues executing until a defined low water mark is reached. Make space requests cannot free up space below the defined low water mark.

If the make space operation is triggered by a user disk quota exceeded condition, the files are selected based on the owner of the file being created or extended, rather than the user of the requesting process.

The cause of a make space request determines the scope of online disk storage that is involved with file selection as follows:

---

<b>WHEN the make space request is initiated by..</b>	<b>THEN...</b>
A high water mark reached or volume full event	All files on the disk volume are potential candidates for the file selection process.
A user disk quota exceeded event	Only files owned by the user whose disk quota was exceeded are potential candidates for the file selection process._

---

## 2.10 Schedule

To prevent storage problems, you set up scheduled execution for preventive policies at regular intervals. HSM provides the capability to schedule policy execution with the following attributes:

- Online volumes
- Execution timing and interval
- Server node

### 2.10.1 Online Volumes

When you schedule a policy execution, you specify the online volumes on which to apply the policy. When setting up a schedule, a separate entry is created for the policy execution for each volume. The volume selection should be based on the goal of maintaining volume capacity between the low water mark and the high water mark at all times. Thus, you need to schedule policies to execute more often on those volumes on which files are frequently created or modified and less often on those volumes on which files are infrequently created or modified.

### 2.10.2 Execution Timing and Interval

Policies can be scheduled to execute at a certain time of day, and at regular intervals. Compaq recommends you run nightly scheduled policy runs at an hour that does not conflict with high system activity or system backups. Ideally, the frequency of policy runs should coincide with the rate of new data creation on the specified volumes. The preventive policy should be run prior to the volume reaching its high water mark capacity, so that all shelving operations can be controlled to occur at certain times of day. This not only reduces overhead of reactive policy execution during the period of high system activity, but also minimizes the use of nearline/offline resources for HSM purposes.

### 2.10.3 Server Node

You can specify the node on which you want the policy to run. Although policies can run on any node that has access to the online volume, cache devices, and nearline/offline devices, it is more efficient if it runs on a shelf server node. If the shelf server node changes, you can use HSM's requeue feature to requeue any and all policy entries to run on an alternative shelf server node.

## 2.11 HSM System Files and Logical Names

HSM uses four logical names that point to devices and directories that hold important files for HSM operations. The logical names are needed because different levels of data reliability are required to ensure proper HSM operation, and for the security of user data. The four logical names are:

- HSM\$CATALOG
- HSM\$MANAGER
- HSM\$LOG
- HSM\$REPACK

The first three logical names must be defined at installation, or later, as system wide logical names affecting all processes. Moreover, the definitions must be the same on all nodes in the cluster. The logical name HSM\$REPACK is optional.

**HSM\$CATALOG** The HSM\$CATALOG logical name points to the location of the default HSM catalog. The catalog contains the information needed to locate a shelved file's data in the cache or the shelf. HSM supports multiple catalogs, which can be specified on a per-shelf basis.

---

### Warning

---

**Loss of any catalog is a critical problem and will probably result in losing the data for shelved files served by that catalog.**

---

HSM catalogs are considered critical files and should be stored on devices and in a directory that has the maximum protection for loss. In particular:

- The devices should be shadowed to recover from disk rashes.
- The devices should be backed-up regularly, and media removed offsite, for disaster recovery.

The size of the catalog file depends on the number of files you intend to shelve on the system. Approximately 1.25 blocks are used for each copy of a file in the cache or the shelf. When a cache copy is flushed to the shelf, the cache catalog entry is deleted. However, copies to the nearline/offline shelf remain permanently in the catalog. For information on backing up the catalog, see Section 5.12.

### 2.11.1 HSM\$MANAGER

The files stored in the location referenced by HSM\$MANAGER are important in HSM operations, but can usually be recovered. These files include:

- All SMU databases
- The shelf handler request log
- The magazine loader database, for HSM Basic mode

Loss of these files will result in a temporarily unusable HSM system, until SMU commands are entered to restore the environment. However, as long as the catalog is available, user data can be recovered. Although the critical level of files in HSM\$MANAGER is not as high as HSM\$CATALOG, the same protection mechanisms are recommended, if possible. At a minimum, a backup of the current SMU database should always be available. The size of the files in HSM\$MANAGER is relatively fixed, but depends on the number of nodes in the cluster. You should allocate 5000 blocks plus 2049 blocks for each node in the cluster.

### 2.11.2 HSM\$LOG

HSM uses the HSM\$LOG location for storing event logs. These logs are written during HSM operation, but their content is designed for the use of the system administrator to monitor HSM activity. As such, their existence is not critical. The size of the event log files can grow rather large if not maintained. However, once the logs have been analyzed by the system administrator, they can be RESET and then deleted.

---

**Note**

---

**The directory specified by HSM\$LOG should have no version limit for files. Failure to do this could result in HSM not starting up on some nodes.**

---

### 2.11.3 HSM\$REPACK

HSM uses the optional HSM\$REPACK logical name to point to a staging area used while repacking archive classes. If the logical name is not defined, the repack function uses HSM\$MANAGER instead. Repack needs a staging area in order to repack files into multi-file savesets. The staging area must be at least 100,000 blocks for repack to function. The staging area is cleaned up after a repack operation.

Repack can be a time consuming process if the catalogs are huge. Repack can be performed in 2 phases which is facilitated by the use of the following qualifiers:

- **/REPORT**

If REPORT option is specified, Repack will only perform the analysis phase of a repack and not actual repacking. This feature would be extremely useful for a system manager to:

- analyze repacking requirements/benefits
- select the most useful threshold values and
- schedule repacks at convenient times.

If used with the /SAVE option, the resultant candidates file will be saved and can be used in subsequent repack/s if the system manager wants the entire repack, as analyzed, to proceed.

- **/RESTART**

Since repacks can take several hours/days to complete, it would be useful to allow the continuation of a repack that had been interrupted for any reason. The /RESTART qualifier would help do this along with /SAVE which would preserve the current candidates file. The repack can be started later from where it left off, without a further analysis or repacking files/volumes that had already been repacked.



---

## Customizing the HSM Environment

This chapter provides a task-oriented description for changing the HSM environment to better suit your operating environment. It contains the following sections:

- Configuring a customized environment
- Implementing shelving policies

For a complete example of a custom configuration for HSM Basic mode or PLUS mode, see the Appendix in the HSM Installation Guide.

### 3.1 Configuring a Customized HSM Environment

This section describes the various definitions used to customize an HSM environment and the operations enabled and disabled by each command.

#### 3.1.1 Customizing the HSM Facility

Commands submitted to the HSM facility control operations across the entire cluster.

##### Enabling and Disabling the Facility

The following options are for enabling or disabling the HSM facility using the SMU SET FACILITY command.

IF You Want to . . .	THEN Use . .
Enable all HSM operations on the cluster	SMU SET FACILITY /ENABLE=ALL
Enable shelving operations throughout the cluster	SMU SET FACILITY /ENABLE=SHELVE
Enable unshelving operations throughout the cluster	SMU SET FACILITY/ENABLE=UNSHELVE
Disable all HSM operations on the cluster	SMU SET FACILITY /DISABLE=ALL
Disable shelving operations throughout the cluster	SMU SET FACILITY /DISABLE=SHELVE
Disable unshelving operations throughout the cluster	SMU SET FACILITY /DISABLE=UNSHELVE

#### 3.1.2 Creating Shelf Definitions

Create shelf definitions that include the archive classes for shelving and unshelving data.

## Customizing the HSM Environment

### 3.1 Configuring a Customized HSM Environment

#### Limitations

The following limitations apply to the number of archive classes, volume sets per archive class, and members per volume set:

For	Basic Mode Limit	Plus Mode Limit
Shelve archive classes	10	10
Restore archive classes	36	36
Total archive classes	36	9999
Tape volume sets	36	Unlimited
Tape volumes per set	99	Unlimited

#### Prevent Inadvertent Application

To prevent inadvertent application of a new shelf definition, disable all operations with the /DISABLE=ALL qualifier and value.

#### 3.1.3 Enabling and Disabling a Shelf Definition

There are three options for enabling and disabling shelving operations that use a particular shelf. The following table lists the options that may be used with the SET SHELF /ENABLE or SET SHELF/DISABLE command.

IF You Want to Control . . .	THEN Use Option . . .
All HSM operations using the named shelf	ALL
Shelving operations using the named shelf	SHELVE
Unshelving operations using the named shelf	UNSHELVE

#### 3.1.4 Modifying Archive Classes

HSM provides multiple archive classes for you to use. You cannot modify the archive class names. You can, however, determine the devices to which an archive class is written and reassign volumes to allow you to move archive class to offsite storage.

IF You Want to . . .	THEN Use . . .
Dismount the current tape volume for specific archive class and continue shelving operations with the next volume in the archive class sequence a	SMU CHECKPOINT archive_id
Assign a nearline or offline tape device or magazine loader to a specific archive class	SMU SET DEVICE/ARCHIVE_ID

In HSM Plus mode, you can modify the media type and density only if the archive class has not been used and no devices or shelves reference the archive class. You can add or remove volume pools as desired.



### 3.1.5 Creating Device Definitions

Create device definitions to identify the devices you will use for shelving operations. Also decide whether to dedicate the devices for the sole use by HSM or to share them with other applications.

### 3.1.6 Modifying Device Definitions

The device definitions let HSM know which devices to use for a given archive class and whether to dedicate or share the devices.

IF You Want to...	THEN Use...
Associate a device with a specific archive class	SMU SET DEVICE/ARCHIVE_ID
Dedicate a device to be used only by HSM	SMU SET DEVICE/DEDICATE
Allow other operations to share a device with HSM	SMU SET DEVICE/SHARED
Remove a device definition from the database	HSM SMU SET DEVICE/DELETE
Disable a device for HSM use	SMU SET DEVICE/DISABLE
Enable a device for HSM use	SMU SET DEVICE/ENABLE

### 3.1.7 Enabling and Disabling a Volume Definition

The volume definition allows you to enable and disable specific reactive policy operations or control operations on the entire volume.

IF You Want to Control ...	THEN Use Option/Qualifier...
All HSM operations on the named volume	SMU SET VOLUME/{ENABLE   DISABLE}=ALL
Shelving operations on the named volume	SMU SET VOLUME/{ENABLE  DISABLE}=SHELVE
Unshelving operations on the named volume	SMU SET VOLUME/{ENABLE   DISABLE}=UNSHELVE
Shelving operations initiated by the high water mark event	/SMU SET VOLUME/{ENABLE   DIS- ABLE}=HIGHWATER_MARK
Shelving operations initiated by the volume full event	/SMU SET VOLUME/{ENABLE   DISABLE}=OCCUPANCY
Shelving operations initiated by the user disk quota exceeded event	/SMU SET VOLUME/{ENABLE   DISABLE}=QUOTA

### 3.1.8 Working with Caches

HSM allows you to defines temporary caches or permanent caches. If you want to use magneto-optical devices with HSM, you must define them as a cache

## Customizing the HSM Environment

### 3.1 Configuring a Customized HSM Environment

IF You Want to . . .	THEN Use . . .
Define an online disk cache	SMU SET CACHE
Tell the cache to flush its data to nearline or offline storage	SMU SET CACHE/AFTER
Control whether the data shelved through the cache is copied to nearline or offline storage when shelving occurs or when the cache is flushed (/NOBACKUP)/(BACKUP)	SMU SET CACHE/{BACKUP   NOBACKUP}
Control whether files shelved to the cache are deleted when the online file is deleted or modified	SMU SET CACHE/[NO]HOLD

Define a magneto-optical device as a permanent cache !SMU SET  
 CACHE/BLOCK=0/BACKUP /NOINTERVAL/HIGHWATER\_MARK=100

#### 3.1.9 Enabling and Disabling a Policy Definition

You can enable or disable specific policy definitions.

IF You Want to . . .	THEN Use . . .
Enable a policy definition	SMU SET POLICY/ENABLE
Disable a policy definition	SMU SET POLICY/DISABLE

Disabling a policy definition affects both primary and secondary policy as follows:

- Disabling a preventive policy causes the files on any disk volume scheduled for shelving with that policy to not be shelved with that policy. If other policies scheduled for the disk volume are enabled, they remain operable.
- The files on any disk volume subject to a make space request-high water mark reached, volume occupancy full, or disk quota exceeded event-are not shelved when the named policy is disabled.

#### 3.1.10 Scheduling Policy Executions

Once you have defined and enabled preventive policies, you may want to ensure they run only at particular times or according to some specific interval.

IF You Want to . . .	THEN Use . . .
Schedule a policy to run immediately	SMU SET SCHEDULE/AFTER
Schedule a policy to run after a specific time	SMU SET SCHEDULE/AFTER=time
Schedule a policy to run according to a regular time interval	SMU SET SCHEDULE/INTERVAL=delta
Schedule a policy to run on a specific shelf server name	SMU SET SCHEDULE/SERVER=node

## 3.2 Implementing Shelving Policies

After installing HSM, you can consider, then implement, your own policies. This section provides a series of tasks implementing both preventive and reactive policies. The guidelines expressed in this section include the commands, definitions, and values that apply to each aspect of creating and implementing policy.

See HSM Command Reference Guide for a complete description of the commands used in this section.

### 3.2.1 Determining the Disk Volumes

Determine the disk volumes on which you want to manage storage capacity. The following example commands are used to perform this task.

To . . .	Use This Command . . .
Determine names of online disk volumes and the amount of capacity used	\$ SHOW DEVICE
Determine user disk quotas and shelving option in user processes	\$ RUN SYSS\$SYSTEM:AUTHORIZE UAF>SHOW <i>username</i>

### 3.2.2 Creating Volume Definitions

Create volume definitions for the disk volumes. Use the SMU SET VOLUME command to create a volume definition and consider the capabilities offered by the volume definitions.

To . . .	Use the Qualifier . . .
Shelve contiguous files Enable all HSM operations and policies on the volume.	/CONTIGUOUS/ENABLE=ALL
Enable the volume for handling a specific trigger condition	/ENABLE=OCCUPANCY or /ENABLE=QUOTA or /ENABLE=HIGHWATER_MARK
Enable shelving or unshelving operations on the volume	/ENABLE=SHELVE or /ENABLE=UNSHELVE
Disable all HSM operations and policies on the volume.	/DISABLE=ALL
Disable the volume for handling a specific trigger condition.	/DISABLE=OCCUPANCY or /DIS- ABLE=QUOTA or /DIS- ABLE=HIGHWATER_MARK
Disable shelving or unshelving operations on the volume	/DISABLE=SHELVE or /DIS- ABLE=UNSHELVE
Define a high water mark for the volume.	/HIGHWATER_MARK=percent
Specify the policy to be executed for volume full or high water mark events.	/OCCUPANCY=policy_name
Specify whether placed files can be shelved.	/PLACEMENT (default)
Specify the policy to be executed for user disk quota exceeded events	/QUOTA=policy_name

## Customizing the HSM Environment

### 3.2 Implementing Shelving Policies

To . . .	Use the Qualifier . . .
Identify the shelf on which to shelve this volume's data. If you do not specify a shelf, HSM uses _HSM\$DEFAULT_SHELF	/SHELF_NAME=shelf_name

#### Prevent Inadvertent Application

To prevent application of a new volume definition before you are ready to do so, disable all operations with the /DISABLE=ALL qualifier and value.

#### Contiguous Files

Files marked contiguous are not normally shelved. If they are, they must be unshelved contiguously. The operation fails if the files cannot be unshelved contiguously.

### 3.2.3 Determining File Selection Criteria

Determine how files should be selected for shelving on a regular basis. The following list gives you some planning considerations:

- Do all disk volumes require the same or different file selection criteria?
- How many users are storing data?
- How much data is being stored by each user?
- What is the purpose of the data stored on the defined disk volumes?
- How often are files created or extended?
- What are the sizes of the files created or extended?
- How would applications or users having to unshelve files be affected?
- How many files are temporary or are expected to be deleted shortly after they are created?

### 3.2.4 Creating Policy Definitions

Create policy definitions that specify the file selection criteria anticipated to be most useful. Use the SMU to create a policy definition considering the capabilities offered.

IF you want to . . .	THEN Use . . .
Choose a file event and time frame	/BACKUP, /CREATED, /EXPIRED, or/MODIFIED, and /BEFORE, /ELAPSED, or /SINCE
Implement file selection algorithms	LRU, STWS or /PRIMARY_POLICY and /SECONDARY_POLICY SCRIPT.
Confirm operations with the policy	/CONFIRM
Use a log file to monitor operations with the policy definition	/LOG
Specify preshelving instead of shelving operations. Note that preshelving is only useful for preventive policies because preshelving does not free disk space	PRESHELVE command

### Prevent Inadvertent Application

To prevent inadvertent application of a new policy definition, disable all operations with the /DISABLE qualifier.

### 3.2.5 Using Expiration Dates

If you plan on using a file's expiration date as an event for file selection, you must make sure the OpenVMS file system is processing them. Follow the procedure in Table 3-1 to establish file expiration dates for the files on the disk volumes.

#### Verifying Privileges

You must be allowed to enable the system privilege SYSPRV or have write access to the disk volume index file to perform this procedure.

#### Setting File Expiration Dates

To set file expiration dates, follow the procedure in Table 3-11. For more information about the OpenVMS command SET VOLUME/RETENTION, see the OpenVMS DCL Dictionary.

**Table 3-1 Procedure for Setting File Expiration Dates**

Step	Action
1	Enable the system privilege for your process: \$ SET PROCESS/PRIVILEGE=SYSPRV
2	Enable retention times for each disk volume on your system: \$ SET VOLUME/RETENTION=(min,[max]) For min and max, specify the minimum and maximum period of time you want the files retained on the disk using delta time values. If you enter only one value, the system uses that value for the minimum retention period and calculates the maximum retention period as either twice the minimum or as the minimum plus 7 days, whichever is less.

Once you set volume retention on a volume, and define a policy using expiration date as a file selection criteria, the expiration dates on files on the volume must be initialized. HSM automatically initializes expiration dates on all files on the volume that do not already have an expiration date upon the first running of the policy on the volume. The expiration date is set to the current date and time, plus the maximum retention time as specified in the SET VOLUME/RETENTION command.

After the expiration date has been initialized, the OpenVMS file system automatically updates the expiration date upon read or write access to the file, at a frequency based on the minimum and maximum retention times.

#### Example of Setting Volume Retention

The following command sets the minimum retention period to 15 days and the maximum to 20 days:

```
$ SET VOLUME DUA0: /RETENTION=(15-0:0, 20-0:0)
```

The following command sets the minimum retention period to 3 days and calculates the maximum. Twice the minimum is 6 days; the minimum plus 7 days is 10. Thus, the value for the maximum is 6 days because that is the smaller value:

```
$ SET VOLUME DUA1: /RETENTION=(3)
```

## Customizing the HSM Environment

### 3.2 Implementing Shelving Policies

If you are not already using expiration dates, the following settings for retention times are suggested:

```
§ SET VOLUME/RETENTION=(1-, 0-00:00:00.01)
```

#### 3.2.6 Creating Schedule Definitions

Use the SMU SET SCHEDULE command to create the schedule definitions that apply the policy definitions to the volume definitions.

IF You Want To	THEN Use the Qualifier
Confirm operations with the schedule	/CONFIRM
Specify the time that the schedule should be first implemented and the interval thereafter at which the policy will be applied to the volume	/INTERVAL and /AFTER

#### 3.2.7 Enabling Preventive Policy

Enable preventive policy on the system by enabling and disabling operations as follows:

Definition	Enable or Disable Qualifiers
Volume	/ENABLE=(SHELVING,UNSHELVING)/DIS- ABLE=(HIGHWATER_MARK,OCCU- PANCY,QUOTA)
Policy	/ENABLE
Shelf	/ENABLE=ALL

This chapter contains information about what a user, not the storage administrator or operator, sees in an HSM environment and explains HSM functions the user can control. It includes the following topics:

- A general description of the user's HSM environment
- Control of file shelving and unshelving

## **4.1 What the User Sees in an HSM Environment**

If the storage administrator has defined policies that control file shelving and unshelving, you (as a typical user) may not be aware that HSM is on the system. Shelving and unshelving files may be almost transparent to you. Or, you may work in an environment where the storage administrator lets you do more of your own data management, in which case you will know HSM is installed. Whether or not you know HSM is on your system, there are some things you will see that let you know just what is going on. There are a few specific ways you will know that HSM is on the system:

- Certain qualifiers on the OpenVMS DIRECTORY command indicate the shelved status of files.
- File access to certain files takes longer than expected.
- You see very few volume full or quota exceeded errors.
- You see messages that refer to shelving or unshelving.

### **4.1.1 Identifying Shelved Data using the DIRECTORY Command**

As described in Chapter 1, HSM shelves file data but retains the file header information in online storage. You can use the DCL DIRECTORY command, with specific qualifiers, to determine if a file is shelved.

To find out which, if any, files have been shelved, use one of the following qualifiers on the DCL DIRECTORY command:

- /FULL
- /SHELVED\_STATE
- /SIZE=ALL

## Using HSM

### 4.1 What the User Sees in an HSM Environment

#### 4.1.1.1 DIRECTORY/FULL

The DIRECTORY/FULL command lists all available information about a file as contained in the file header.

Example:

```
$ DIR/FULL
Directory SYS$SYSDEVICE:[COLORADO]
CONFIG_LOG.TXT;1          File ID: (3346,2,0)
Size:          56/0      Owner:    [COLORADO]
Created: 08-Apr-2002 12:04:56.85
Revised: 08-Apr-2002 14:24:01.41 (7)
Expires:      <None specified>
Backup:      <No backup recorded>
Effective:   <None specified>
Recording:   <None specified>
File organization: Sequential
Shelved state: Shelved
File attributes: Allocation: 0, Extend: 0, Global buffer
count: 0
                Version limit: 3
Record format: Variable length, maximum 137 bytes
Record attributes: Carriage return carriage control
RMS attributes: None
Journaling enabled: None
File protection: System:RWED, Owner:RWED, Group:RE, World:R
DECW$SM.LOG;2          File ID: (3270,13,0)
Size:          5/6      Owner:    [COLORADO]
Created: 08-Apr-2002 08:16:14.08
Revised: 08-Apr-2002 14:24:01.47 (3)
Expires:      <None specified>
Backup:      <No backup recorded>
Effective:   <None specified>
Recording:   <None specified>
File organization: Sequential
Shelved state: Online
File attributes: Allocation: 6, Extend: 0, Global buffer
count: 0
                Version limit: 3, Not shelvable
Record format: VFC, 2 byte header
Record attributes: Print file carriage control
RMS attributes: None
Journaling enabled: None
File protection: System:RWED, Owner:RWED, Group:RE, World:
Access Cntrl List: None
```

#### 4.1.1.2 DIRECTORY/FULL for Unpopulated Index Files

If you shelve an empty (unpopulated) index file, the file size will look different after you shelve it if you do a DIRECTORY/FULL on the file. In Example 4-1 notice that the file size before shelving is 3/3 and after shelving, its 0/0. When you see this, do not be alarmed. No data has been lost. This is a normal representation of an unpopulated index file.

#### Example 4-1 Shelve an empty (unpopulated) indexed file

```
$ CREATE/FDL=HSM$CATALOG.FDL EMPTY_INDEXED.DAT
$ DIRECTORY/FULL EMPTY_INDEXED.DAT
Directory DISK$USER1:[SHELVING_FILES]
Example 4-1 (Cont.) Shelve an empty (unpopulated) indexed file
EMPTY_INDEXED.DAT;1          File ID: (645,26,0)
Size:          3/3      Owner:    [SYSTEM]

Created: 08-Apr-2002 14:18:13.79
Revised: 08-Apr-2002 14:18:13.93 (1)
Expires:      <None specified>
Backup:      <No backup recorded>
Effective:   <None specified>
```



## 4.1 What the User Sees in an HSM Environment

```

Recording: <None specified>
File organization: Indexed, Prolog: 3, Using 5 keys
Shelved state: Online
File attributes: Allocation: 3, Extend: 0, Maximum bucket size: 2
                  Global buffer count: 0, Version limit: 3
                  Contiguous best try
Record format: Variable length, maximum 484 bytes, longest 0 bytes
Record attributes: None
RMS attributes: None
Journaling enabled: None
File protection: System:R, Owner:RWED, Group:, World:
Access Cntrl List: None
Total of 1 file, 3/3 blocks.
$ SHELVE EMPTY_INDEXED.DAT
$ DIRECTORY/FULL EMPTY_INDEXED.DAT
Directory DISK$USER1:[SHELVING_FILES]
EMPTY_INDEXED.DAT;1 File ID: (645,26,0)
  Size: 0/0 Owner: [SYSTEM]
  Created: 08-Apr-2002 14:18:13.79
  Revised: 08-Apr-2002 14:18:13.93 (5)
  Expires: <None specified>
  Backup: <No backup recorded>
  Effective: <None specified>
  Recording: <None specified>
  File organization: Indexed, further information shelved
  Shelved state: Shelved
  File attributes: Allocation: 0, Extend: 0, Maximum bucket size: 2
                  Global buffer count: 0, Version limit: 3
                  Contiguous best try
Record format: Variable length, maximum 484 bytes, longest 0 bytes
Record attributes: None
RMS attributes: None
Journaling enabled: None
File protection: System:R, Owner:RWED, Group:, World:

Total of 1 file, 0/0 blocks.

```

## 4.1.1.3 DIRECTORY/FULL for Populated Indexed Files

When you shelve a populated index file, and do a DIRECTORY /FULL on it afterwards, the file size will look different afterwards. In Example 4-2 you will notice that the file size went from 84/84 to 84/0. This is normal. The displayed size of a populated indexed file appears normal in the directory listing.

## Example 4-2 Shelf a Populated indexed file

```

$ COPY HSM$CATALOG:HSM$CATALOG.SYS POPULATED_INDEXED.DAT
$ DIRECTORY/FULL POPULATED_INDEXED.DAT
Directory DISK$USER1:[SHELVING_FILES]
POPULATED_INDEXED.DAT;1 File ID: (691,51007,0)
  Size: 84/84 Owner: [SYSTEM]
  Created: 08-Apr-2002 14:30:47.15
  Revised: 08-Apr-2002 14:30:47.31 (1)
  Expires: <None specified>
  Backup: <No backup recorded>
  Effective: <None specified>
  Recording: <None specified>
  File organization: Indexed, Prolog: 3, Using 5 keys
  Shelved state: Online
  File attributes: Allocation: 84, Extend: 0, Maximum bucket size: 2
                  Global buffer count: 0, Version limit: 3
Record format: Variable length, maximum 484 bytes, longest 0 bytes
Record attributes: None
RMS attributes: None
Journaling enabled: None
File protection: System:RWED, Owner:RWED, Group:RE, World:
Access Cntrl List: None
Total of 1 file, 84/84 blocks.
$ SHELVE POPULATED_INDEXED.DAT;1

```

## Using HSM

### 4.1 What the User Sees in an HSM Environment

```
$ DIRECTORY/FULL POPULATED_INDEXED.DAT
Directory DISK$USER1:[SHELVING_FILES]
POPULATED_INDEXED.DAT;1                File ID: (691,51007,0)
Size: 84/0                               Owner: [SYSTEM]
Created: 08-Apr-2002 14:30:47.15
Revised: 08-Apr-2002 14:30:47.31 (5)
Expires: <None specified>
Backup: <No backup recorded>
Effective: <None specified>
Recording: <None specified>
File organization: Indexed, further information shelved
Shelved state: Shelved
File attributes: Allocation: 0, Extend: 0, Maximum bucket size: 2
                  Global buffer count: 0, Version limit: 3

Record format: Variable length, maximum 484 bytes, longest 0 bytes
Record attributes: None
RMS attributes: None
Journaling enabled: None
File protection: System:RWED, Owner:RWED, Group:RE, World:
Total of 1 file, 84/0 blocks.
```

#### 4.1.1.4 DIRECTORY/SHELVED\_STATE

The DIRECTORY/SHELVED\_STATE command lists the files and a keyword that tells you if the file is online or shelved.

Example:

```
$ DIR/SHELVED
Directory DISK$MYDISK:[IAMUSER]
A1.DAT;1                Shelved
AA.A;1                  Shelved
BAD_LOGIN.COM;1        Shelved
BOINK.EXE;1            Shelved
BUILD.DIR;1            Online
CLUSTER_END_031694.COM;1
                        Shelved
CLUSTER_TEST_030194.COM;2
                        Shelved
CLUSTER_TEST_030394.COM;1
                        Shelved
CMA.DIR;1              Online
CODE.DIR;1             Online
COSI.DIR;1             Online
COSI_TEST.DIR;1       Online
...
Z6.DAT;1               Shelved
Z7.DAT;1               Shelved
Z8.DAT;1               Shelved
Z9.DAT;1               Shelved
Total of 153 files.
```

#### 4.1.1.5 DIRECTORY/SIZE

The DIRECTORY/SIZE command lists the size of the files in the directory. The allocated file size for a shelved file is 0. If you use /SIZE=ALL, OpenVMS displays both the used and allocated blocks for the files (as shown in the example below). If you use /SIZE=ALLOC, OpenVMS displays only the allocated file size for the files.

Example:

```
$ DIR/SIZE=ALL
Directory DISK$MYDISK:[IAMUSER]
A1.DAT;1                1/0
AA.A;1                  5/0
BAD_LOGIN.COM;1        6/0
BOINK.EXE;1            10/0
BUILD.DIR;1            4/24
```

## 4.1 What the User Sees in an HSM Environment

```

CLUSTER_END_031694.COM;1                2/0
CLUSTER_TEST_030194.COM;2                1/0
CLUSTER_TEST_030394.COM;1                1/0
CMA.DIR;1                                1/3
CODE.DIR;1                               21/54
COSI.DIR;1                               1/54
COSI_TEST.DIR;1                          8/9
...
Z6.DAT;1                                 1/0
Z7.DAT;1                                 1/0
Z8.DAT;1                                 1/0
Z9.DAT;1                                 1/0
Total of 153 files, 42199/42339 blocks.

```

### 4.1.2 Accessing Files

You use the same DCL commands and application programs to access shelved files as you would online data files. If you are working on a system that is running HSM, you will notice some differences in file access time. When shelving is occurring, file access time may be temporarily lengthened while the shelving process completes.

When you access a currently shelved file through a read, write, extend, or truncate operation, it may take longer for that file to be accessed than you would expect. You may see a message indicating that unshelving is occurring.

Depending on the storage device being used to shelve and unshelve the data, you may experience a large or small increase in the access time. Table 4–1 shows how various storage devices relate to file access time in an HSM environment.

**Table 4–1 Typical File Access Time by Storage Device**

Storage Device	Typical Access Time
HSM cache	Approximately two times the normal access time for online storage
Magneto-optical jukebox	Within 30 seconds
Nearline robotic tape	Less than 5 minutes/device
Offline device using human retrieval	May range from minutes to several days

These access times depend on the type of storage device used, rather than on the working time of HSM. In other words, if you already use various storage devices to access your data, using HSM will not significantly increase your access time.

### 4.1.3 Decreasing Volume Full and Disk Quota Exceeded Errors

Well-defined shelving policies will decrease the number of volume full and user disk quota exceeded conditions on your system. However, if the volume should become full or if you exceed your OpenVMS-defined disk quota, HSM may shelve files according to policies defined by the storage administrator.

## Using HSM

### 4.2 Controlling Shelving and Unshelving

#### 4.1.4 Viewing Messages

When you access a currently shelved file through a read, write, extend, or truncate operation, you might see a message like this:

```
%HSM-I-UNSHLVPRG, unshelving file $1$DUA0:[MY_DIR]AARDVARKS.TXT
```

If you attempt to create or extend a file and there is not enough space available to do so, you might see this message:

```
%HSM-I-SHLVPRG, shelving files to free disk space
```

You see these messages only if you have enabled /BROADCAST on your terminal.

### 4.2 Controlling Shelving and Unshelving

From your perspective, shelving and unshelving files can be defined to occur automatically or manually. In the case of automatic shelving and unshelving, the storage administrator defines policies that control this behavior and you may not realize shelving and unshelving are occurring. In the case of manual shelving and unshelving, you issue specific commands to shelve and unshelve files.

#### 4.2.1 Automatic Shelving Operations

If the storage administrator defines policies to shelve and unshelve files, you do not need to specifically request files be shelved and unshelved. In this case, the storage administrator decides when data ought to be shelved based on various criteria discussed in Chapter 2.

You may not notice when the files are shelved and may only notice when a file is unshelved if the file access time is significantly longer than expected. You can find out if you have shelved files using the qualifiers discussed above for the DIRECTORY command.

#### 4.2.2 User-Controlled Shelving Operations

To specifically shelve a file (or files), use the DCL SHELVE command or the DCL PRESHELVE command.

Using the SHELVE command frees up disk space by shelving files you do not expect to need soon and by minimizing the possibility that files you do intend to use are not shelved automatically.

Using the PRESHELVE command copies the file to shelf storage. The data in the file remains in your work area. Preshelving files allows the system to respond more rapidly when it needs to free up disk space for use.

---

#### Note

---

**To shelve a file, you must have READ and WRITE access to that file.**

---

#### Canceling an Explicit SHELVE or PRESHELVE Operation

To stop an explicit shelving operation, type Ctrl/Y. The operation will complete on the file that is currently being shelved. All files that were shelved before you entered the Ctrl/Y will remain shelved. To cancel any remaining pending operations, you must reenter the command using the /CANCEL qualifier, as shown in the following example:

```
$ SHELVE *.TXT Ctrl/Y  
$ SHELVE/CANCEL *.TXT
```

### File Selection for Explicit Shelving

HSM provides three methods to select files for explicit shelving:

- Explicitly naming files  
You can use one or more file specifications, including wildcards.
- File event and time span  
You can include files based on a time span around one of four file dates. The file dates used include the following:  
Creation date  
Backup date  
Modification date  
Expiration date  
Time values are specified with the /SINCE and /BEFORE qualifiers.
- File size  
In addition to specifying file names, file dates, and time spans, you have the option of further limiting the files selected for shelving. The additional criteria considers file size and is specified with the /SELEC qualifier. Table 4–2 lists three options for applying the /SELECT qualifier.

**Table 4–2 File Selection**

Files with Block Sizes . . .	Enter This Qualifier and Option . . .
Smaller than that specified	/SELECT=SIZE=MAXIMUM=n
Greater than or equal to that specified	/SELECT=SIZE=MINIMUM=n
Falling within the specified range	/SELECT=SIZE=(MINIMUM=n,MAXIMUM=m)

### Shelving or Preshelving Specific File Versions

You have the option of specifying the number of file versions you shelve or preshelve with any manual operation. In most cases, you want to shelve the earlier versions of a file, leaving later versions of the file available for immediate access.

To specify the number of versions to keep in primary storage, use the /KEEP qualifier with the SHELVE or PRESHELVE command.

### Time to Complete Shelving Operations

When you enter the PRESHELVE or SHELVE command, the amount of time taken to complete the operation depends on the following factors:

- The amount of data  
The number and size of the files to be preshelled or shelved will determine how long the operation takes. More and/or larger files require more time to process than fewer and/or smaller files.
- Online cache  
When you implement online cache, the operation requires approximately twice the amount of time taken to perform an OpenVMS COPY operation to copy the files to another disk.
- Using the /NOWAIT qualifier

## Using HSM

### 4.3 Finding Lost Data

By using the /NOWAIT qualifier, HSM returns control of the user process in which the PRESHELVE or SHELVE command was entered. The operation is then carried out in the context of the HSM system process.

#### 4.2.3 Unshelving Files

You can cause a shelved file to be returned to primary storage through one of the following methods:

- Enter a DCL command to read, write, extend, or truncate a shelved file. This causes a file fault that initiates an implicit HSM unshelving operation.
- Use the UNSHELVE command to explicitly unshelve a file. This operation requires that you have read access to the file.

When you access the data of a shelved file through a file fault, you will receive the following message as the file is being routinely unshelved:

```
$ EDIT AARDVARKS.TXT
%HSM-I-UNSHLVPRG, unshelving file $1$DUA0:[MY_DIR]AARDVARKS.TXT
```

#### Canceling an UNSHELVE Request

To cancel an implicit unshelving of a file, enter Ctrl/Y. This action immediately stops the operation and results in the file remaining at its status before you entered the command that caused the file to be unshelved.

To stop an explicit unshelving operation, enter Ctrl/Y. The operation will complete on the file that is currently being unshelved. All files that were unshelved before you entered the Ctrl/Y will remain unshelved. To cancel any remaining pending operations, you must reenter the command using the /CANCEL qualifier, as shown in the following example:

```
$ UNSHELVE *.TXT Ctrl/Y
$ UNSHELVE/CANCEL *.TXT
```

### 4.3 Finding Lost Data

If you have lost data you think was shelved, see your storage administrator. There are several procedures, explained in Section 5.9, that the storage administrator can use to find the lost data.

### 4.4 Working with Remote Files

You can perform all regular DCL command line operations on files residing in a system or VMSccluster from a remote node in the same manner as you can for operations on a local node. However, you cannot use the HSM DCL commands (SHELVE, PRESHELVE, and UNSHELVE) on remote files.

Implicit shelving and unshelving operations are possible for remote systems. Unlike local operations, you do not receive the "Unshelving filename" or "Shelving Files To Free Disk Space" status messages for remote operations.

If you cancel an implicit operation on a file from a remote node (implicit operations only are allowed), the operation will continue at the HSM system, but the request will be canceled without returning the result of the operation to the remote node.

### 4.5 Resolving Duplicate Operations on the Same File

If two users simultaneously enter duplicate command on the same file, HSM performs the operation for both users as if each had entered the command alone. For example, if an UNSHELVE command is entered on the same file, HSM unshelves the file once and issues duplicate success messages.

### 4.5.1 Resolving Conflicting Operations on the Same File

If two users simultaneously enter conflicting commands on the same file, the action taken by HSM is dependent upon the nature of the conflicting commands. A summary of the actions taken by HSM is given in Table 4–3

**Table 4–3 How HSM Resolves Conflicting Requests**

WHEN the first request is ...	AND the next request is ...	THEN this operation is canceled...
DELETE <b>DELETE</b> PRESHELVE	PRESHELVE <b>UNSHELVE</b> DELETE	PRESHELVE <b>UNSHELVE</b> PRESHELVE
PRESHELVE PRESHELVE <b>SHELVE</b>	SHELVE UNSHELVE <b>DELETE</b>	PRESHELVE PRESHELVE <b>SHELVE</b>
SHELVE DELETE <b>SHELVE</b>	PRESHELVE SHELVE <b>UNSHELVE</b>	PRESHELVE SHELVE <b>SHELVE</b>
UNSHELVE UNSHELVE UNSHELVE	DELETE PRESHELVE SHELVE	UNSHELVE PRESHELVE SHELVE

- Unshelve means either an explicit UNSHELVE or a file fault.
- Shelve means either an explicit SHELVE or a make space request.

## 4.6 Controlling Other HSM Functions

In addition to explicitly shelving and unshelving files, you can perform the following file management tasks:

- Use the SET FILE/NOSHELVABLE to specify that a file be excluded from HSM shelving and preshelving operations. The default is to have all files shelveable.
- Use the SET PROCESS/NOAUTO\_UNSHELVE to require that a file be unshelved through an explicit UNSHELVE command only. Accessing a file from a process on which this condition is set will result in a message that you must explicitly unshelve the file. The default is that all shelved files can be implicitly unshelved by HSM.

Check with your system manager to determine if the defaults have been changed for your installation.





---

## Managing the HSM Environment

This chapter provides information on managing and maintaining your systems in an HSM environment. Storage administrators will find this information especially useful. This chapter is divided into two main parts:

1. Normal system management operations that require some changes due to the presence of HSM. It is important that these procedures be following to maintain correct system operation and data integrity in an HSM environment. Such operations include:
  - Dismounting disks
  - Copying shelved files
  - Renaming disks
  - Restoring files to another disk
2. System management operations that are required to support HSM. These operations include:
  - Protecting system files from shelving
  - DFS, NFS, and PATHWORKS access support
  - Ensuring data safety with HSM
  - Using backup strategies with HSM
  - Recovering lost user data
  - Disaster recovery
  - Maintaining shelving policies
  - Managing HSM catalogs
  - Repacking archives and shelf volumes
  - Replacing and creating archive classes
  - Replacing a lost or damaged shelf volume
  - Catalog analysis and repair
  - Consolidated backup with HSM
  - Determining cache usage
  - Maintaining file headers
  - Event logging
  - Activity logging
  - Converting from Basic mode to Plus mode

## Managing the HSM Environment

### 5.1 Dismounting Disks

## 5.1 Dismounting Disks

When HSM performs shelving operations on online disk volumes, it opens a file on each disk. This file can remain open for extended periods of time. If you need to dismount a disk that supports HSM operations, you may need to disable the HSM operations before the dismount can take place.

For normal online volumes that HSM has accessed, disable all HSM operations on the disk:

```
$ SMU SET VOLUME device_name /DISABLE=ALL
```

In addition, if the disk has been defined as an HSM cache device, delete the cache definition or disable the cache:

```
$ SMU SET CACHE device_name/DELETE
```

Because the cache disk contains files necessary to support HSM, the disk cannot be dismounted until all the cache files are flushed to the nearline/offline archive classes. Deleting the cache initiates a cache flush, which may take from minutes to hours to complete.

If you need to dismount the disk immediately for any reason (without initiating a cache flush), you should disable the cache instead using the following command:

```
$ SMU SET CACHE cache_name /DISABLE
```

Note that if you dismount a cache disk, users will not be able to access shelved file data that remains in the cache.

You should not dismount the disks referenced by the logical names HSM\$CATALOG, HSM\$MANAGER, or HSM\$LOG, otherwise you will seriously disrupt HSM operations. If this is absolutely necessary, follow these procedures:

- Shut down HSM
- Define a new location for the appropriate logical names
- Copy HSM\$\*. \* from the old locations to the new locations
- Start up HSM

If you need to dismount a disk containing a shelf catalog, you should move the catalog to another disk using the SET SHELF command prior to dismounting the original disk. For example:

```
$ SMU SET SHELF shelf_name/CATALOG=new_location
```

Note that this operation may take tens of minutes to hours to complete. See Section 5.12 for more details on this operation.

## 5.2 Copying Shelved Files

Very often, it is necessary to move a directory tree of files from one location to another, most often to a new larger disk. If you use the normal OpenVMS facilities COPY or BACKUP to perform this operation, any shelved files in the source directory will be unshelved prior to copying to the destination. While this is safe, it is usually undesirable because it forces the unshelving of dormant data, which only becomes active due to the COPY or BACKUP being performed.

HSM provides a means to copy shelved files in the shelved state and update the HSM catalog to the new locations. This is achieved by using the SMU COPY command, which accepts a full file specification as input, and a disk/directory specification on output - files are not renamed.

If you are "moving" shelved files from one location to another on the same disk, the OpenVMS RENAME command is recommended. SMU COPY should be used to copy shelved files to another disk in the same HSM environment. If you are copying files to be taken to a different

system (outside of the current HSM environment), then COPY or BACKUP should be used to unshelve the files prior to the copy.

The SMU COPY command implicitly uses the BACKUP utility which has different semantics to the OpenVMS COPY command, especially when using wildcard directory trees. Therefore, you should review the behavior of BACKUP wildcard operations when using this command. Specifically, the following are examples of correct operation:

```
$ SMU COPY DISK$USER1:[JONES...]*.*;* DISK$USER15:[JONES...]  
$ SMU COPY DISK$PROD1:[ACCOUNTS...]*.*;* DISK$PRODARC:[ARCHIVE.ACCOUNTS...]  
$ SMU COPY $1$DKA100:[000000...]*.*;* $15$DKA100:[*...]
```

The first example moves user JONES' directory tree from one disk to another, preserving all subdirectories from the input disk on the output disk.

The second example moves all files from DISK\$PROD1:[ACCOUNTS...] and all subdirectories to a new disk and new subdirectory structure, preserving all subdirectories from DISK\$PROD1:[ACCOUNTS] to DISK\$PRODARC:[ARCHIVE.ACCOUNTS].

The third example moves all files from \$1\$DKA100: to \$15\$DKA100: preserving all subdirectories. Note, however, that the following syntax does not provide the expected results:

```
$ SMU COPY $1$DKA100:[000000...]*.*;* $15$DKA100:[000000...]
```

The above example flattens the (sub)directory structure in somewhat unpredictable ways, which is usually not desired. Please avoid this form of the command.

Note also that SMU COPY will not preserve more than seven levels of subdirectory, which is a restriction imposed by BACKUP.

---

**Warning**

---

**Do not use HSM\$BACKUP to copy shelved files from one disk to another. While this might appear to work, the HSM catalog is not updated and the output files may not be able to be unshelved. SMU COPY is the only supported mechanism to copy shelved files from one location to another.**

---

## 5.3 Renaming Disks

It is often necessary to rename disks on the system, and this has an impact on the ability of HSM to process shelved files. There are two ways to rename disks from an HSM viewpoint:

- Change a logical name pointing to a disk, but leaving the alldevnam alone. For example, you may change the logical name pointing to \$1\$DKA100: from DISK\$CURRENT\_ACCOUNTS to DISK\$PAST\_ACCOUNTS, but the actual contents of the disk as referred to by its alldevnam does not change. For this kind of change, no HSM action is required, since HSM stores catalog information using *alldevnam*.
- Rename the alldevname of a disk in any way. For example, you might want to change the allocation class of a disk from \$2\$DUA400: to \$15\$DUA400:, or change the physical unit number of a disk.

If you perform the second type of rename you must:

- Ensure that the SMU volume database for the old and new disk names refer to the same HSM shelf. This is vital so that HSM can access the correct catalog for access. There are three possible valid configurations:
  - Neither volume is defined in the SMU database, and by default use the shelf defined in the default volume record

## Managing the HSM Environment

### 5.4 Restoring Files to a Different Disk

- Both volumes are defined in the SMU database, and both are using the same shelf (not necessarily the default shelf)
- One of the volumes is defined in the SMU database, and this volume uses the same shelf as defined in the default volume record
- Run SMU ANALYZE/REPAIR on the newly-renamed disk. This creates catalog entries for (pre)shelved files on the new disk.

---

#### Note

---

**Please note that failure to assign the same shelf for the old and new disks and/or failure to run SMU ANALYZE/REPAIR after the name change may result in the inability to unshelve files.**

---

### 5.4 Restoring Files to a Different Disk

Very often after a disk failure, or other reason, it is desirable to restore files from a backup copy to a different disk than the one from which the backup was originally taken. If the backup copy contains shelved and preshelved files, such a restore will create a discrepancy between the online location of the files, and the location stored in the HSM catalogs.

As such, it is necessary to perform the same recovery operations as for renaming disks, namely:

- Ensure the new disk name is served by the same shelf as the original disk
- Restore the files
- Run SMU ANALYZE/REPAIR to correct the HSM catalog information for the new disk

See Section 5.3 for complete details.

### 5.5 Protecting System Files from Shelving

There are certain critical files that you must not delete or shelve if you are using HSM. These files include:

- Critical HSM product files
- OpenVMS operating system files on the system disk
- Other files that HSM will not shelve

Considerations regarding the handling of these files are discussed in this section.

#### 5.5.1 Critical HSM Product Files

The HSM product files listed in Table 5-1 must not be deleted or shelved. During installation, these files are protected from deletion and marked /NOSHELVABLE, but care must be taken to prevent inadvertent deletion or shelving.

Compaq strongly recommends that the disks on which these files reside be shadowed and backed up on a regular basis (both image and incremental).<sup>1</sup>

**Table 5–1 Critical HSM Files**

Files	Remarks
HSM\$CATALOG:*.;*.*	Required HSM default catalog file.
HSM\$MANAGER:*.;*.*	Required HSM database files.
[000000]HSM\$UID.SYS	Contains the volume UID structure. Note that HSM\$UID.SYS is not created until the first use of HSM after installation. There will be an HSM\$UID.SYS file on each volume that has HSM operations enabled.
Any shelf catalog	Defined in the shelf structure

### Shelf Catalogs

The HSM shelf catalogs contain the information needed to locate and unshelve all files that have been shelved. The catalog locations are defined in the SMU SHELF database. It is recommended that all catalog names begin with "HSM\$" to preclude any possibility that they could be shelved. If a shelf catalog suffers an unrecoverable loss, access to the associated shelved file data can also be lost. For this reason, the shelf catalogs are an essential part of the HSM environment.

You must protect the shelf catalogs from loss or corruption by using one or more of the following procedures:

- Backing up the catalogs on a regular basis; daily backups are recommended
- Shadowing the disk(s) containing the catalogs
- For additional protection, periodically copying the catalog files to different file names and locations

### Recovering Critical Files

If any or all of the critical HSM product files are deleted, they should be restored from the latest backup sets as soon as possible. HSM should be shut down during the restore process.

Data shelved since the last backup may be lost.

## 5.5.2 OpenVMS System Files and System Disks

Compaq recommends that shelving be disabled on system disks. If shelving is allowed on system disks, critical files may be shelved when a policy is triggered. Serious performance degradation or a deadlock during boot operations may result when these files are accessed. You can disable shelving on system disks with the following command:

```
SMU> SET VOLUME/DISABLE=ALL SYS$SYSDEVICE:
```

If shelving is allowed on system disks, care should be taken to avoid shelving system-critical files by using SET FILE/NOSHELVABLE for each system file. The HSM installation process will perform this operation on OpenVMS system files but not on layered product files. Certain files on the system disk have the /NOSHELVABLE flag set by default. These flags should not be reset.

## Managing the HSM Environment

### 5.6 DFS, NFS and PATHWORKS Access Support

#### 5.5.3 Files Not Shelved

HSM does not shelve or preshelve the following files:

- Directory files
- Open files
- Deleted and corrupted files
- Empty files
- Files whose names begin with HSM\$
- Files with defined logical block placements (optional)
- Files marked by the SET FILE /NOMOVE command
- Files marked by the SET FILE /NOSHELVABLE command
- Files on volumes marked by the SMU SET VOLUME volume\_name/DISABLE=SHELVE command
- Contiguous files (optional, see Section 5.7.2)
- Files that are larger than 45 percent of the total online volume capacity

## 5.6 DFS, NFS and PATHWORKS Access Support

HSM Version 3.0A supports access to shelved files from client systems where access is through DFS, NFS and PATHWORKS. At installation, HSM sets up such access by default. However, you may want to review this access and change it as needed, because it can potentially affect all accesses.

### 5.6.1 DFS Access

File faulting (and therefore file events) work as expected, with the exception of Ctrl/Y. Typing Ctrl/Y during a file fault has no effect. The client process waits until the file fault completes and the file fault is not canceled.

In addition, with DFS one can determine the shelved state of a file just as if the disk were local (i.e. DIRECTORY /SHELVED and DIRECTORY/SELECT both work correctly).

The SHELVE and UNSHELVE commands do not work on files on DFS-served devices. The commands do work on the cluster that has local access to the devices, however.

### 5.6.2 NFS Access

The normal default faulting mechanism (fault on data access), does not work for NFS-served files. The behavior is as if the file is a zero-block sequential file. Performing "cat", for example, (or similar commands) results in no output.

However, at installation time, HSM Version 3.0A enables such access by defining a logical name that causes file faults on an OPEN of a file by the NFS server process. By default, the following logical name is defined:

```
$ DEFINE/SYSTEM HSM$FAULT_ON_OPEN "NFS$SERVER"
```

This definition supports access to NFS-served files upon an OPEN of a file. If you do not want NFS access to shelved files, simply de-assign the logical name as follows:

```
$ DEASSIGN/SYSTEM HSM$FAULT_ON_OPEN
```

For a permanent change, this command should be placed in:

```
SYS$STARTUP:HSM$LOGICALS.COM
```

## Managing the HSM Environment

### 5.6 DFS, NFS and PATHWORKS Access Support

For NFS-served files, file events (device full and user quota exceeded) occur normally with the triggering process being the NFS\$SERVER process. The quota exceeded event occurs normally because any files extended by the client are charged to the client's proxy not NFS\$SERVER.

If the new logical is defined for the NFS\$SERVER, the fault will occur on OPEN and will appear transparent to the client, with the possible exception of messages as follows:

```
% cat /usr/bubble/shelve_test.txt.2
NFS2 server bubble not responding still trying
NFS2 server bubble ok
```

The first message appears when the open doesn't complete immediately. The second message (ok) occurs when the open completes. The file contents, in the above example, are then displayed.

Typing Ctrl/C during the file fault returns the user to the shell. Since the NFS server does not issue an IO\$\_CANCEL against the faulting I/O, the file fault is not canceled and the file will be unshelved eventually.

It is not possible to determine whether a given file is shelved from the NFS client. Further, like DFS devices, the SHELVE and UNSHELVE commands are not available to NFS clients.

#### 5.6.3 PATHWORKS

Normal attempts to access a shelved file from a PATHWORKS client initiate a file fault on the server node. If the file is unshelved quickly enough (e.g. from cache), the user sees only the delay in accessing the file. If the unshelve is not quick enough, an application-defined timeout may occur and a message window pops up indicating the served disk is not responding. The timeout value depends on the application. No retry is attempted. However, this behavior can be modified by changing HSM's behavior to a file open by returning a file access conflict error, upon which most PC applications retry (or allow the user to retry) the operation after a delay. After a few retries, the file fault will succeed and the file can be accessed normally. To enable PATHWORKS access to shelved files using the retry mechanism, HSM defines the following logical name on installation:

```
$ DEFINE/SYSTEM HSM$FAULT_AFTER_OPEN "PCFS_SERVER, PWRK$LMSRV"
```

This definition supports access to PATHWORKS files upon an OPEN of a file. If you do not want PATHWORKS to access shelved files via retries, simply de-assign the logical name as follows:

```
$ DEASSIGN/SYSTEM HSM$FAULT_AFTER_OPEN
```

For a permanent change, this command should be placed in:

```
SYS$STARTUP:HSM$LOGICALS.COM
```

The decision on which access method to use depends upon the typical response time to access shelved files in your environment.

If the logical name is defined, HSM imposes a 3-second delay in responding to the OPEN request for PATHWORKS accesses only. During this time, the file may be unshelved: otherwise, a "background" unshelve is initiated which will result in a successful open after a delay and retries.

At this point, the file fault on the server node is under way and cannot be canceled.

The affect of the access on the PC environment varies according to the PC operating system. For windows 3.1 and DOS, the computer waits until the file is unshelved. For Windows NT and Windows-95, only the windows application itself waits.

## Managing the HSM Environment

### 5.7 Ensuring Data Safety with HSM

File events (device full and user quota exceeded) occur normally with the triggering process being the PATHWORKS server process. The quota exceeded event occurs normally because any files extended by the client are charged to the client's proxy not the PATHWORKS server.

It is not possible from a PATHWORKS client to determine whether a file is shelved. In addition, there is no way to shelve or unshelve files explicitly (via shelve or unshelve commands). There is also no way to cancel a file fault once it has been initiated.

Most PC applications are designed to handle "file sharing" conflicts. Thus, when HSM detects the PATHWORKS server has made an access request, it can initiate unshelving action, but return "file busy". The typical PC application will continue to retry the original open, or prompt the user to retry or cancel. Once the file is unshelved, the next OPEN succeeds without shelving interaction.

#### 5.6.4 Logical Names for NFS and PATHWORKS Access

As just discussed, HSM supports two logical names that alter the behavior of opening a shelved file for NFS and PATHWORKS access support. These are:

- *HSM\$FAULT\_ON\_OPEN* - This logical name forces a file fault on an Open of a file for the processes listed in the equivalence name, and the open waits until the file fault is complete. Designed for use with the NFS server.
- *HSM\$FAULT\_AFTER\_OPEN* - This logical name forces a deferred file fault on the file when it is opened. If the fault completes within three seconds, the open completes successfully, otherwise it fails with "file busy", but initiates a "background" file fault. Repeated attempts to open the file will eventually succeed. Designed for use with the PATHWORKS server.

The default behavior is to perform no file fault on Open; rather the file fault occurs upon a read or write to the file.

Each logical name can take a list of process names to alter the behavior of file faults on open. For example:

```
$ DEFINE/SYSTEM HSM$FAULT_ON_OPEN "NFS$SERVER, USER_SERVER, SMITH"
```

The *HSM\$FAULT\_ON\_OPEN* can also be assigned to "HSM\$ALL", which will cause a file fault on open for all processes. This option is not allowed for *HSM\$FAULT\_AFTER\_OPEN*.

As these logicals are defined to allow NFS and PATHWORKS access, they are not recommended for use with other processes, since they will cause many more file faults than are actually needed in a normal OpenVMS environment. When used, the logicals must be system-wide, and should be defined identically on all nodes in the VMScluster environment.

These logical name assignments or lack thereof take effect immediately without the need to restart HSM.

## 5.7 Ensuring Data Safety with HSM

This section explains specific considerations about keeping shelved data safe.

### 5.7.1 Access Control Lists for Shelved Files

Access control lists (ACLs) for shelved files should not be deleted. In particular, the following commands should not be entered for shelved or preshelved files:

```
$ SET ACL /DELETE=ALL
$ SET FILE /ACL /DELETE=ALL
```



If the ACLs for shelved files are deleted, data is usually recovered automatically because a full catalog scan is performed. This causes a degradation of HSM performance. If the catalog scan fails, the data usually can be recovered manually using the SMU LOCATE command.

You may modify or delete ACE entries not used by HSM, for example, file protection ACEs.

### **5.7.2 Handling Contiguous and Placed Files**

By default, HSM does not shelve files marked contiguous, files that must occupy sequential blocks of disk space. If these files are shelved, HSM will not unshelve them to noncontiguous disk space. If HSM cannot unshelve the file to contiguous space, it aborts the operation and displays an error message. When this happens, defragment the disk to restore contiguous space and retry the operation.

Placed files are files that are placed on specific blocks of disk space by an application. By default, HSM shelves these files, but does not necessarily unshelve placed files to their original location on the disk volume.

Usually, this change is not critical to the operation of an application. If a problem arises with a placed file after unshelving, the file should be set to NOSHELVABLE, or you can use the SMU SET VOLUME/NOPLACEMENT command to cause these files to not be shelved for a specified volume.

## **5.8 Using Backup Strategies with HSM**

This section explains backup strategies you may want to use to protect data shelved through HSM. There are several areas of concern:

- Backing up critical HSM files
- Backing up data shelved through HSM
- Backing up information stored in an online cache

### **5.8.1 Backing up Critical HSM Files**

As explained in Section 5.5.1, HSM requires certain files to operate. To facilitate HSM recovery in the event a disaster occurs, Compaq strongly recommends you backup these critical files using one of the methods described in this section. This is a preventive situation; if you do not use one of these methods to backup the critical files, you may not be able to easily recover shelved data after a disaster.

#### **5.8.1.1 Defining a Backup Strategy**

If you already have a backup strategy designed and implemented on your system for the volume on that the critical HSM project files reside, then these files will be backed up as part of that implementation.

If, however, you do not have an existing strategy defined, you will need to define one. You need to consider the following things:

- What data needs to be saved
- How often does that data need to be saved
- Where does the data need to be stored when saved

#### **5.8.1.2 Using OpenVMS BACKUP to Save the Files**

The OpenVMS BACKUP utility provides two major methods of backing up your files: image backup (also called full backup) and incremental backup. The image backup saves all files on a disk into a save set. The incremental backup saves only those files that have been created or modified since the last image or incremental backup.

## Managing the HSM Environment

### 5.8 Using Backup Strategies with HSM

#### 5.8.1.3 Maintaining a Manual Copy of the Files

If you do not want to use a general backup strategy or product to back up your critical HSM files or if you just want an additional way to ensure they are safe, you can always create manual copies of the files. Just use the OpenVMS COPY command to copy the files to another location, probably on another disk. If you do this, Compaq recommends you develop an automated procedure to do this on a regular basis.

#### 5.8.2 Backing Up Shelved Data

Once data is shelved, there are several mechanisms you can use to ensure there is a backup copy of that data:

- Use multiple archive classes for each shelf
- Move archive classes to offsite locations
- Use OpenVMS BACKUP to back up the shelved file headers for disaster recovery purposes (image backup only)

##### 5.8.2.1 Considerations for OpenVMS BACKUP and Shelving

If you want to use OpenVMS BACKUP to maintain backup copies of your shelved data, there are some specific issues you need to consider.

###### Image Backups

HSM can reduce the amount of space needed on your image backups, and the time required to do them. When doing image backups under HSM, only the file headers of shelved files are backed up. The data itself remains shelved.

###### Incremental Backups

Files modified since the last backup are backed up as a part of the incremental process unless specifically excluded. If a modified file is shelved before the next incremental backup, it is unshelved for the incremental backup.

To avoid the delay caused by retrieving file contents needlessly during an incremental backup, you should do incremental backups at a shorter interval than specified by HSM policy. This causes the files to be backed up before being shelved, thereby avoiding the unshelving delay.

When planning your image backups, remember that only the file headers are backed up. If you have shelved a file that has been modified or created since the last incremental backup, its data is not backed up. This can be avoided by keeping the files online for at least one incremental backup.

When an otherwise unmodified file is shelved, it is not unshelved and backed up again during the next incremental backup because its revision date is not changed by the shelf operation. This precludes unnecessarily long incremental backup times when infrequently used files are shelved.

##### 5.8.2.2 Using Multiple HSM Archive Classes for Backup

Safety of shelved data is ensured by establishing multiple archive classes per shelf. Through the multiple archive classes, duplicate copies of your data are automatically made when files are shelved. Compaq recommends that one or more of these copies be stored in the same place as your system backups, perhaps in a remote location and preferably in a vault.

### 5.8.2.3 Storing HSM Archive Classes Offsite

The SMU CHECKPOINT command allows you to dismount the current tape used for shelving that is associated with a specific archive class. In this way, copies can be removed from the system and separately stored for disaster recovery purposes. The next shelf operation for the archive class will be applied to the next tape volume for the archive class.

### 5.8.3 Backing Up Data Stored in an Online Cache

Because an online cache is part of online storage, it is backed up as part of your defined backup strategy. If, however, you use the online cache as a staging area to a shelf, there are some additional considerations for ensuring the information in the cache is backed up.

#### 5.8.3.1 Flushing the Cache

When you "flush" the cache, data that was stored in the cache is copied to the specified nearline or offline device. Once the copy is complete, the data in the cache is deleted. As a result, you need to ensure that the data is backed up while in the cache or is flushed to multiple archive classes for shelf storage.

## 5.9 Finding Lost User Data

There are two particular areas in which HSM can be used to recover lost user data:

- Access to shelved data has been lost
- An online file header has been deleted

In each of these instances, if you have defined multiple archive classes for HSM, you should be able to retrieve the data automatically from one of the defined archive classes. In other instances, such as when the online file has been deleted, you may need to use SMU LOCATE to find the shelved file data.

### Using SMU LOCATE

The SMU LOCATE command retrieves full information about a file's data locations from the shelving catalog. SMU LOCATE reads the HSM catalog(s) directly to find a shelved file's data locations.

You should note that SMU LOCATE does not work quite the same way as a typical OpenVMS utility when it comes to look-up and wildcard processing. The file-descriptor you supply as input (including any wildcards) applies to the file as stored in the HSM catalog at the time of shelving. Thus, for example:

- You may locate a shelved file by name, even if it has been deleted from the online system, unless the file was shelved to a cache defined with /NOHOLD.
- If the file has been renamed on the online system, you should use the old name (current at the time of shelving) to locate it.
- You also can identify a file by file identifier (FID), which together with a device name, uniquely identify a file, regardless of any renaming that may have been done after shelving.
- If you do not specify a device and/or directory in the SMU LOCATE command, it uses a default of \*:[000000...]\*.\*.\*.

When you retrieve information using SMU LOCATE, several instances or groups of stored locations may be displayed. These reflect the locations of the file when it was shelved at various stages of its life. You should carefully review the shelving time and revision time of the file to determine which, if any, is the appropriate copy to restore.

## Managing the HSM Environment

### 5.10 Disaster Recovery

#### Recovering Data from a Lost Shelved File

Although HSM tries to restore data from all known locations automatically, even when some of the file's metadata is missing, there may be occasions when this fails. In these situations, you should use SMU LOCATE to locate the file's data, then attempt to restore the data through BACKUP (from tape) or COPY (from cache).

If the user is certain file data was shelved, but is unable to simply retrieve that data through either an implicit or explicit unshelving operation, use the following procedure to find and retrieve the missing data:

1. Use SMU LOCATE to search the shelving catalog for the location of the shelved data.
2. Try to unshelve the data, perhaps using UNSHELVE /OVERRIDE.
3. If this fails, use BACKUP to restore the data from nearline or offline media or use the COPY command to restore the data from an online cache.

## 5.10 Disaster Recovery

HSM provides tools that allow you to prevent loss of HSM data. This section describes various ways you can use these tools.

### 5.10.1 Recovering Data Shelved Through HSM

If you have a site disaster in which your onsite data is unavailable, you may be able to recover that data from BACKUP files and tapes dismounted using the SMU CHECKPOINT command.

Once onsite, the following sequence is recommended:

1. Using the OpenVMS BACKUP utility, restore your files from the most recent image backup.
2. Then, also using the OpenVMS BACKUP utility, restore any since that image backup.
3. For any additional data you shelved and moved offsite through SMU CHECKPOINT, use the media with your archive classes from the offsite storage location as your shelf media.
4. Finally, in case another disaster occurs, you should recreate the offsite archive class, or selected volumes, by using SMU REPACK and the /FROM\_ARCHIVE qualifier. This allows you to either keep the formerly offsite volume onsite and take the new volumes offsite, or keep the new volumes onsite and remove the original offsite volumes back offsite. Alternatively, you could use the SHELVE/SELECT=NOONLINE command to reshelve files, although this is much slower.

### 5.10.2 Recovering Critical HSM Files

If you lose any of the following HSM data, you must recover it before HSM will function correctly:

- HSM database
- HSM catalogs
- HSM\$UID files

### Recovering Critical Files

If any or all of the critical HSM product files are deleted and you have backed up this information through a mechanism such as the OpenVMS BACKUP utility, you should restore them from the latest backup sets (including incremental backups) as soon as possible. Then, you should restart HSM.

---

**Note**

---

**You may lose data shelved since the last image (or incremental) backup.**

---

### Recovering the HSM Database

Although you could reinstall the HSM database from your installation kit, this procedure would lose all the current information in your HSM database. Because this is policy data, you can recreate it easily.

### Recovering the HSM Catalogs

The HSM catalogs are essential to recovering shelved data. If you do not use BACKUP to create a backup of the catalogs, you could backup the catalogs by making copies of the catalog files and storing them in a safe location. Then, once you have restored any other pieces of the HSM system, you can copy the catalog files back over into the proper locations for HSM to use it. These locations are defined by the logical name HSM\$CATALOG for the default catalog, and the locations specified in the SMU SHELF database for other shelf catalogs.

### Recovering the HSM\$UID File

If you do not have a backup copy of the HSM\$UID file, HSM will create a new one with a different UID. If you then attempt to unshelve files, you may see an error message. To correct this problem, use UNSHELVE/OVERRIDE to override the UID conflict.

## 5.10.3 Recovering Boot-Up Files

If you inadvertently shelved your boot-up files, you can only recover them if you have an alternate system disk you can use to boot the system and then unshelve the files.

## 5.10.4 Reshelving an Archive Class

The most efficient way to recover an archive class is to use the SMU REPACK command, and specify a /FROM\_ARCHIVE and one or more volumes with the /VOLUME qualifier. This command uses the /FROM\_ARCHIVE to retrieve shelved data and copy it to the archive class containing the lost shelf media. See Section 5.15 for more details.

An alternative but much slower way to reclaim lost shelf media is to reshelve files. Use the following command:

```
§ SHELVE/SELECT=NOONLINE
```

This variation of the SHELVE command shelves only data whose status is SHELVED, not ONLINE. It transparently unshelves the data from its current archive class and reshelves the data to any new archive classes. Data in an archive class is reshelled also if the online ACL is deleted.

## 5.11 Maintaining Shelving Policies

This section explains how to evaluate your policy definitions with respect to the HSM policy model. Understanding this model will help you define the most effective policies for your environment.

## Managing the HSM Environment

### 5.11 Maintaining Shelving Policies

#### 5.11.1 The HSM Policy Model

This section presents a model-related concepts-that explains how shelving works. Understanding the model will help you define and manage an effective shelving policy.

By implementing HSM, you can maintain a reasonable amount of available online storage capacity, and reduce the cost of storing large amounts of data.

Your particular disk configurations and their usage dictate specific values to consider when you create the various definitions. The policies you implement with HSM determine how you meet your storage management needs.

##### 5.11.1.1 Concepts of HSM Policy

To apply these concepts, first think of each of your online disk volumes in terms of its total online storage capacity. Then, consider how much space should always remain available.

The central element of policy is the latitude of available online storage capacity you maintain.

Figure 5-1 shows the HSM policy model. Table 5-2 provides definitions for each of the concepts shown in the figure.

**Figure 5–1**

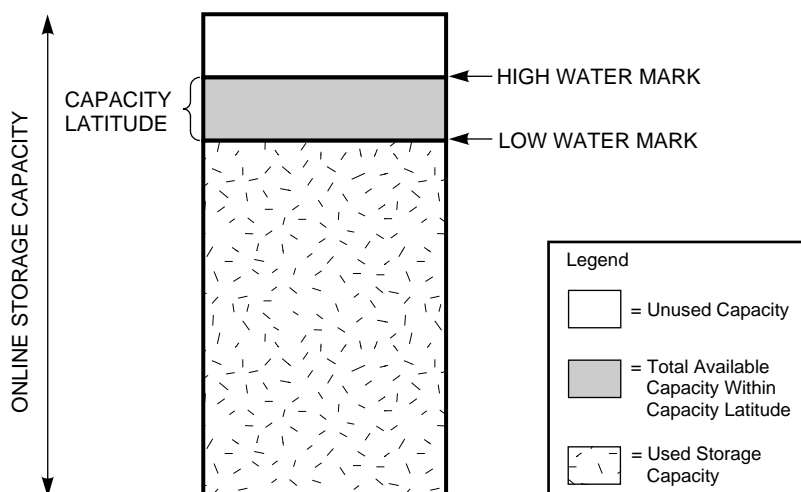

CXO-4095A-MC

**Table 5–2 HSM Policy Model Concept Definitions**

Concepts	Definitions
Maximum capacity	The total online storage capacity you are allowed to occupy on an online disk volume. This is a threshold for reactive shelving determined by the capacity of the online disk volume.
High water	A value you define to automatically trigger mark the shelving process. This is a threshold for reactive shelving that you determine.
Low water	The shelving goal expressed in terms of a mark percentage of disk capacity.

Table 5–2 HSM Policy Model Concept Definitions

Concepts	Definitions
Capacity latitude	The capacity latitude is the range you create, monitor, and manage to make sure you are efficiently using your online storage resources. Adjusting the limits of this latitude determines the operating efficiency of your system.

5.11.1.2 Policy Governs the Shelving Process

The policies you implement by creating and modifying the various HSM definitions govern the shelving process. This example of reactive policy shows you how the HSM system reacts to a high water mark event, returning the available capacity to the low water mark.

Figure 5-2 shows the policy model in the stages of the shelving process. Table 5-3 lists the stages of the shelving process as they occur in response to reactive policy

Figure 5–2

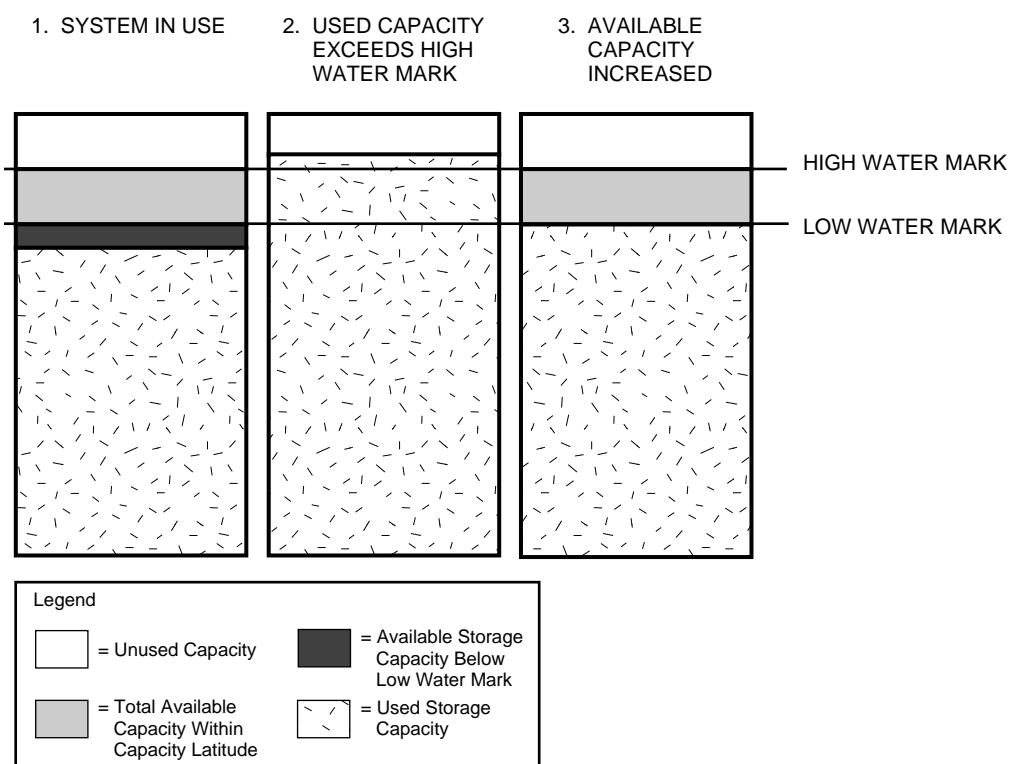

CXO-4094A-MC

## Managing the HSM Environment

### 5.11 Maintaining Shelving Policies

**Table 5–3 Process for Shelving to Reactive Policy**

Stage	Event
1	<p>The system is in use. Online storage capacity is within the limits that define the capacity latitude.</p> <p><u>Implications:</u> When the amount of online storage capacity lies within the capacity latitude, it implies the following:</p> <ul style="list-style-type: none"> <li>• The files on the disk are frequently accessed, meeting the demands of their applications and users for immediate access.</li> <li>• Enough space is available to accommodate new files or extensions to files on the disk volume.</li> <li>• Enough space is available to accommodate unshelved files if they need to be accessed.</li> <li>• Average access latency is acceptable for the users and applications whose files are shelved from the disk volume</li> </ul>
2	<p>Used storage capacity exceeds the defined high water mark. This condition is caused by a user or application requiring more capacity than is allowed by definition on the online disk volume. Any of the following require more online storage:</p> <ul style="list-style-type: none"> <li>• Creating a new file</li> <li>• Extending an existing file</li> <li>• Unshelving a file</li> </ul>
3	<p>Available capacity increases in response to the event. HSM automatically moves those files meeting the selection criteria in the policy definition to shelf storage.</p> <p><u>Implications:</u> Having completed the shelving process implies the following:</p> <ul style="list-style-type: none"> <li>• The likelihood that shelved files will be accessed soon is small because the use and access patterns were matched to the file selection criteria.</li> <li>• Adequate disk space has been made available to satisfy additional requests for storage for an acceptable of time.</li> </ul>

#### 5.11.1.3 The Balance to Achieve When Implementing Policy

An effective HSM policy balances these two conditions:

- Maintaining an adequate amount of available online storage space
- Achieving adequate overall system response time by shelving files that are least likely to be accessed

#### 5.11.2 HSM Policy Situations and Resolutions

The model described in Section 5.11.1 has practical application. This section demonstrates how the model can be applied to help monitor the effectiveness of policy in various situations.

##### 5.11.2.1 Situation : Volume Occupancy Full Event

One of the benefits of HSM is the ability to implement a preventive policy that helps avoid volume occupancy full events. Figure 5-3 shows the policy model as it applies during a volume occupancy full event.



Figure 5-3

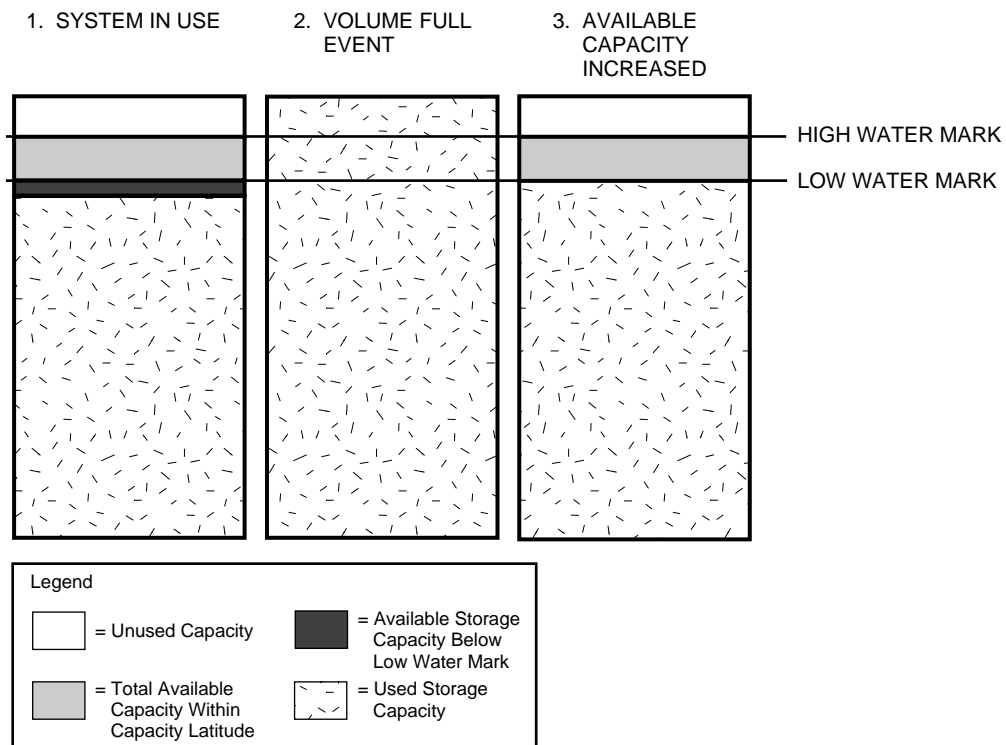

CXO-4096A-MC

### Resolution

If volume occupancy full events occur while your preventive policy is in effect, you can do either or both of the following actions to avoid them:

- Decrease the high water mark
- Increase the frequency of scheduled policy

#### 5.11.2.2 Situation : Shelving Goal Not Reached

The goal is an important part of policy as it is the result of the shelving process controlled through file selection criteria in the policy definition. Figure 5-4 shows the policy model when a shelving policy fails to reach its defined goal.

## Managing the HSM Environment

### 5.11 Maintaining Shelving Policies

Figure 5-4

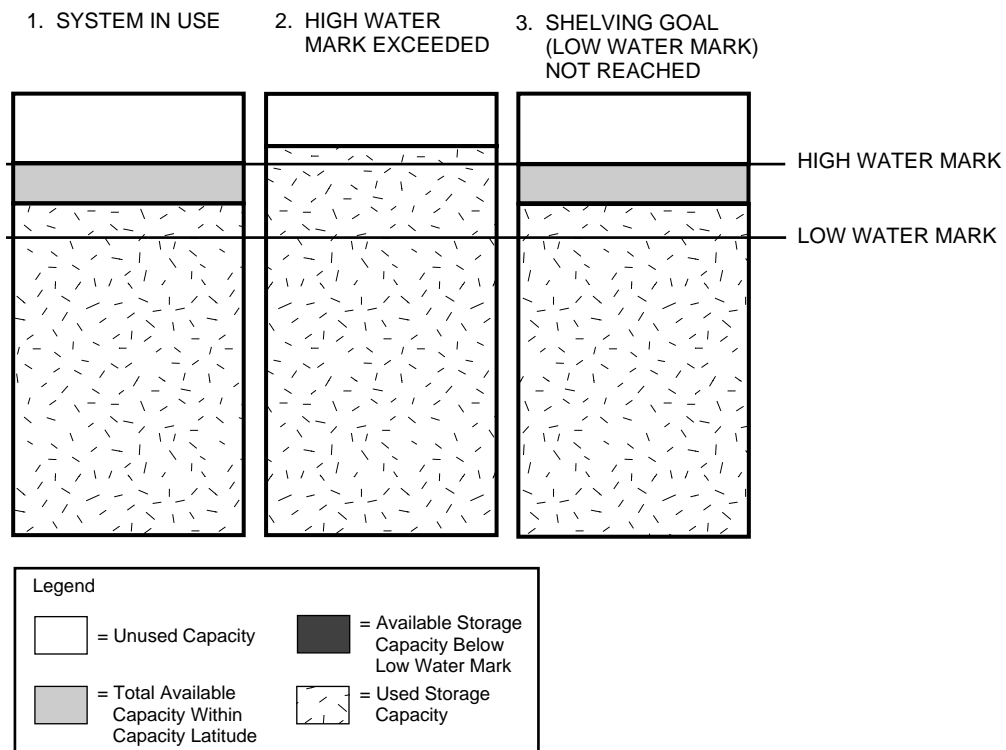

CXO-4099A-MC

#### Resolution

If shelving operations fail to reclaim the defined capacity, you can do either or both of the following actions to make sure your shelving goal is reached:

- Change the file selection criteria to include more files
- Increase the low water mark value

#### 5.11.2.3 Situation : Frequent Reactive Shelving Requests

Your reactive policy should be planned and implemented as a contingency. As such, shelving in response to reactive policy should occur infrequently. The policy model in Figure 5-5 shows the policy that creates frequent requests for reactive policy.

Figure 5-5

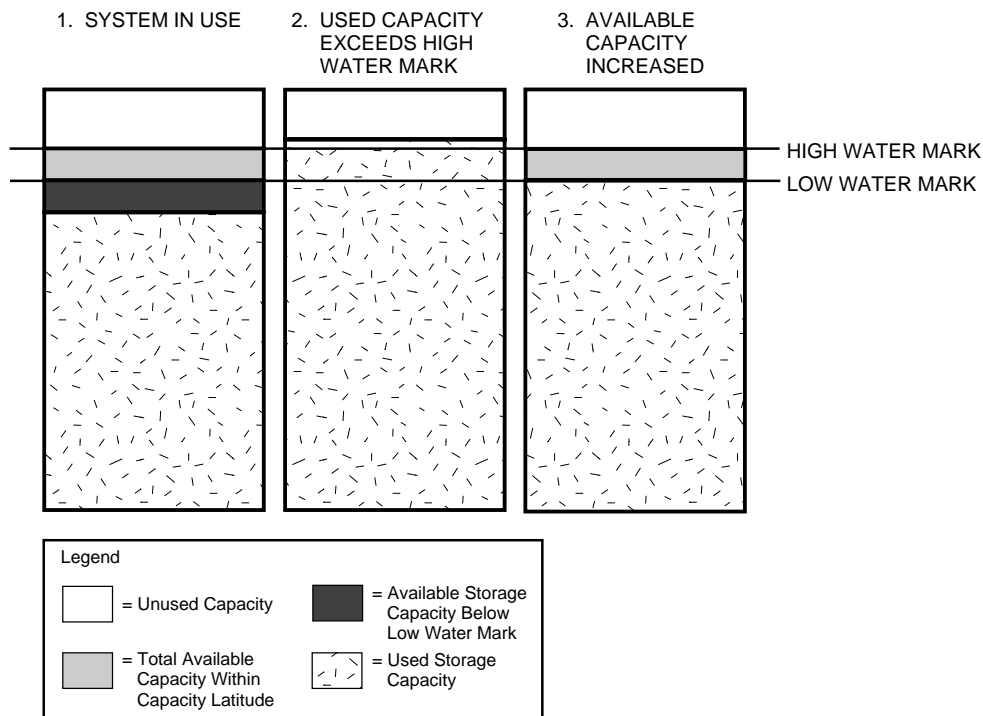

CXO-4100A-MC

### Resolution

If your system experiences frequent reactive shelving requests, you can take the following actions:

WHEN the Trigger Is . . .	THEN You Should . . .
High water mark reached	Increase the high water mark value, decrease the low water mark value or both.
User disk quota exceeded	Decrease the low water mark.

#### 5.11.2.4 Situation : Application and User Performance Impeded

With HSM, you design and implement policy that allows you to maintain available online capacity and retain data on less expensive media. The trade-off with implementing HSM is that when shelved files are needed, applications and users trying to access them must wait until the files are restored. Figure 5-6 shows the policy model in a situation when available storage is maintained at the expense of application and user performance.

## Managing the HSM Environment

### 5.11 Maintaining Shelving Policies

Figure 5-6

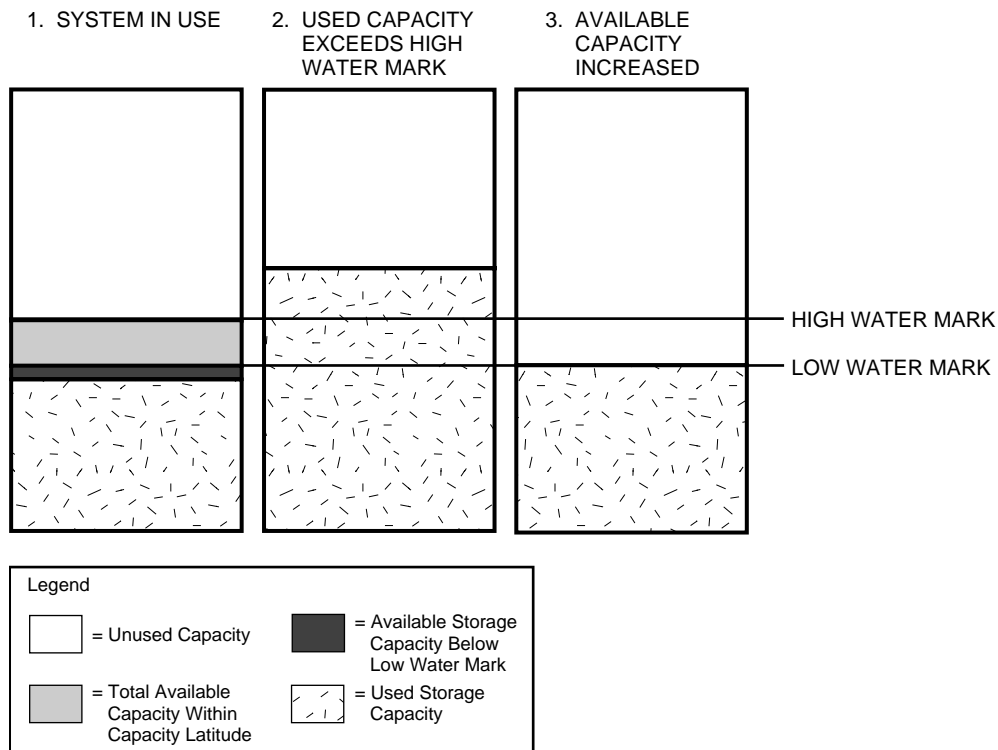

CXO-4098A-MC

#### Resolution

If your applications or users experience delays in their work, or if productivity drops because files must frequently be unshelved to be accessed, you can do any or all of the following actions:

- Implement online cache
- Increase the high water mark value
- Increase the low water mark value

#### 5.11.3 Ranking Policy Execution

HSM provides the means to determine what a policy execution would do before the policy is run. This process is called ranking a policy on a volume, and is initiated by the SMU RANK command.

This feature helps you determine the effectiveness of your policies by letting you see exactly what files would be shelved if the policy were run. The files are listed in the order that they would be shelved. Ranking applies only to policies that use the automatic algorithms STWS and LRU. HSM cannot rank policies based on user script files.

Compaq recommends that you rank all your policies before putting them into a production environment.

The following example shows how to rank a policy:

```
$ SMU RANK DISK$USER1: HSM$DEFAULT_OCCUPANCY
Policy HSM$DEFAULT_OCCUPANCY is enabled for shelving
Policy History:
  Created: 20-OCT-1999 10:36:36.45
  Revised: 20-OCT-1999 11:26:21.09
Selection Criteria:
  State: Enabled
  Action: Shelving
  File Event: Expiration date
  Elapsed time: 180 00:00:00
  Before time: <none>
  Since time: <none>
  Low Water Mark: 80 %
  Primary Policy: Space Time Working Set(STWS)
  Secondary Policy: Least Recently Used(LRU)
Verification:
  Mail notification: <none>
  Output file: <none>
Volume capacity: 2271640 blocks
Current utilization: 1818245 blocks
Volume lowwater mark: 1817312 blocks
Blocks to be reclaimed: 933
Executing primary policy definition
DISK$USER1:[SMITH]WATCH_BATCH.COM;5
  date: 21-OCT-1999 size: 462
DISK$USER1:[SMITH]LOCAL_DB.COM;1
  date: 20-OCT-1999 size: 279
DISK$USER1:[SMITH]PERSONAL.LGP;1
DISK$USER1:[SMITH]REMOTE.MEM;1
  date: 20-OCT-1999 size: 57
Total of 4 files ranked which will recover 951 blocks
Volume lowwater mark can be reached
```

## 5.12 Managing HSM Catalogs

When you install HSM for the first time, all HSM shelving data is placed in the default catalog, located at:

```
HSM$CATALOG:HSM$CATALOG.SYS
```

As the amount of shelving information increases over time, Compaq recommends that you define multiple shelves, distribute your disk volumes amongst these shelves, and define a separate catalog for each shelf. Compaq recommends that a shelf be associated with between 10 and 50 volumes each, depending on the size of the volumes and the amount of shelving activity on those volumes.

After analyzing your storage subsystem and coming up with a distribution plan for volumes and shelves, the following commands can be used to implement this distribution, for example:

```
$!
$! Define new shelves with separate catalogs
$!
$ SMU SET SHELF PRODUCTION_SHELF1 -
_$ / CATALOG=DISK$SYSTEM2:[HSM.CATALOG]HSM$PRODUCTION_SHELF1_CAT.SYS
$ SMU SET SHELF PRODUCTION_SHELF2 -
_$ / CATALOG=DISK$SYSTEM2:[HSM.CATALOG]HSM$PRODUCTION_SHELF2_CAT.SYS
$!
$! Re-associate volumes to the new shelves
$!
$ SMU SET VOLUME DISK$USER1:/SHELF=PRODUCTION_SHELF1
$ SMU SET VOLUME DISK$USER2:/SHELF=PRODUCTION_SHELF1
$ . . . . .
$ . . . . .
$ SMU SET VOLUME DISK$USER20:/SHELF=PRODUCTION_SHELF2
$ SMU SET VOLUME DISK$USER21:/SHELF=PRODUCTION_SHELF2
$
```

## Managing the HSM Environment

### 5.12 Managing HSM Catalogs

It is recommended that the catalog file names are preceded by "HSM\$" to eliminate any possibility that they might be shelved: shelving a catalog file is not supported and can lead to serious problems.

These are the only commands you need to enter to distribute your volumes among shelves, and to populate the catalogs.

When you enter these commands, HSM begins a process called split-merge, which moves shelving data from the old catalog to the new catalog for a volume. A split-merge operation can be initiated by either command.

Since potentially thousands of catalog entries are affected by a spit-merge, the process can take several minutes or even hours to complete. During this time, the associated volume and/or shelf is associated with two catalogs - the old and the new. These can be seen by issuing an SMU SHOW VOLUME or SMU SHOW SHELF during a split-merge, which have special displays as shown in the examples below:

```
$!  
$! SMU displays when changing a shelf for a volume:  
$!  
$ SMU SHOW VOLUME _$15$DKA300:/FULL  
Volume _$15$DKA300: on Shelf HSM$DEFAULT_SHELF, Shelving is enabled,  
Unshelving is enabled, Highwater mark detection is disabled, Occu-  
pancy full detection is disabled, Disk quota exceeded detection is disabled  
  
Created:          8-FEB-1998 15:57:54.32  
Revised:          8-FEB-19986 15:58:28.44  
Ineligible files: <contiguous>  
Highwater mark:  90%  
OCCUPANCY Policy: HSM$DEFAULT_OCCUPANCY  
QUOTA Policy:    HSM$DEFAULT_QUOTA  
Split/Merge state: COPY  
Alternate shelf:  PRODUCTION_SHELF1  
$!  
$! SMU displays when changing a catalog for a shelf:  
$!  
$ SMU SHOW SHELF  
Shelf TEST_SHELF1 is enabled for Shelving and Unshelving  
Catalog File:    DISK$USER1:[HSM.CATALOG]HSM$CAT1.SYS  
Shelf History:  
Created:          1-DEC-1998 11:44:46.26  
Revised:          28-DEC-1998 15:22:00.91  
Backup Verification: Off  
Save Time:        <none>  
Updates Saved:    All  
Archive Classes:  
Archive list:     HSM$ARCHIVE01 id: 1  
Restore list:     HSM$ARCHIVE01 id: 1  
Split/Merge state: COPY  
Alternate Catalog: DISK$USER1:[HSM.CATALOG]HSM$CAT2.SYS
```

You may notice that the catalogs change positions during the split-merge between While a split-merge is in progress, certain HSM operations may proceed normally, some HSM operations are suspended, while certain others are rejected. Suspending an operation means that the operation is queued until the split-merge is completed, while rejection means that the command must be re-entered at a later time. The following table indicates the disposition of requests during a split-merge:

**Table 5–4 HSM Request Disposition During a Split-Merge Operation**

Operation	Disposition
(Pre)shelve to cache	Processed
(Pre)shelve to tape	Suspended
Unshelve from cache	Processed
Unshelve from tape	Processed
Unpresshelve	Processed
Cache flush to tape	Suspended
Compatible split- merge	Processed
Incompatible split- merge	Rejected
Repack archive class	Suspended
All other requests	Processed

HSM initiates split-merge operations in the background; the SMU command that initiated the split merge does not wait for the operation to complete. As such, it is possible to request an incompatible split-merge operation, for example:

```
$ SMU SET VOLUME DISK$USER1/SHELF=SHELF1
$ SMU SET VOLUME DISK$USER1/SHELF=SHELF2
```

In this example, the second command is rejected while the split-merge for the first command is processed.

If an error occurs during a background split-merge operation, the final completion state of the operation will either revert to the old definition, or the new definition, depending on the phase of split-merge that failed. There are essentially two phases of split-merge:

- COPY - Copying the shelf data from the old to the new catalog
- DELETE - Deleting the information from the old catalog

If an error occurs during the copy phase, the SMU database is reset to the old catalog/shelf. If an error occurs during the delete phase, the new catalog/shelf definition stays in effect.

You may wish to examine the database later with SMU to determine if the operation succeeded and the definitions are as you expect. Also, the shelf handler audit and error logs contain entries for all split-merge operations for further information.

## 5.13 Repacking Archive Classes

Shelf media used by HSM contain shelved file data from many sources, some of which remains valid for a long time, but some also becomes obsolete. Unlike BACKUP tapes, which can be recycled regularly, this is not the case with HSM media, since they contain the only copies of the shelved file data. Without some sort of custom analysis of HSM media, the media would have to be retained indefinitely. After a long time, where the majority of the data is obsolete, this would result in shelf media having a very low percentage of valid data, resulting in wastage.

## Managing the HSM Environment

### 5.13 Repacking Archive Classes

HSM provides the SMU REPACK function to perform an analysis of valid and obsolete data on shelf media, and copy the valid data to other media, allowing the old media to be freed up. In addition, REPACK purges the catalog entries associated with the obsolete data.

Shelf file data can become obsolete in two ways:

- The online copy of the shelved file is deleted
- The online copy of the shelved file is unshelved, updated, and shelved again

HSM provides the system administrator a way to control the obsolescence of files for use in repacking. It may not be appropriate for a file to become obsolete as soon as it is deleted or updated, as it may need to be recovered in its old state at a later date. As such, two new options are provided in the SMU SHELF definition as follows:

- **SAVE\_TIME** - This option allows the specification of a delta time which keeps a file's shelved data in the HSM subsystem for this period after the file is deleted.
- **UPDATES** - This option allows the specification of a number of updates to a shelved file that will be kept in the HSM subsystem. This option applies to files that have been updated in place, not new versions of files that have been created after an update. New versions are controlled by online disk maintenance outside the scope of HSM.

Complete flexibility is applied to both options ranging from zero delete save time and no updates, to indefinite delay and number of updates, and anything in between. The options apply to all preshelved and shelved files on all volumes in the shelf.

Repacking is normally applied to all volumes in an archive class. However, the system administrator can restrict the volumes being repacked by specifying them in a /VOLUME qualifier. If any of the specified volumes are part of a volume set, all volumes in the volume set will be repacked.

Finally, it may or may not be worth repacking a particular volume or volume set depending on the percentage of valid data on the volume. For example, if a volume contains 90% valid data, the 10% bonus in space acquired by repacking the volume may not justify the effort of repacking, at least not yet. As such, the system administrator can apply a threshold percentage value of obsolete data that is used to determine whether to repack a particular volume or volume set. The default threshold value is 50%.

A threshold value should only be applied when repacking to the same archive class. When repacking to create a new archive class or replacing a shelved volume, all valid files should be repacked by specifying /NOTHRESHOLD.

Repacking requires two compatible tape devices in order to proceed. For this reason, HSM allows only ONE repack operation at a time. In addition, a REPACK request is suspended while a catalog split-merge operation is in progress; the two operations cannot safely proceed simultaneously.

The following example shows a normal repack operation:

```
§ SMU REPACK 1
```

This command repacks archive class 1 to new media also in archive class 1. The default threshold value of 50% is applied. When the operation is complete, the old media for archive class 1 are deallocated.



## Managing the HSM Environment

### 5.14 Replacing and Creating Archive Classes

Repack requires a disk staging area of at least 100,000 blocks in order to produce optimal multi-file save sets on output. For example, files shelved with HSM V1.x into single-file save sets are consolidated into more efficient multi-file save sets on output. The staging area used is referenced by the system-wide logical name HSM\$REPACK, which should be assigned to a suitably sized disk/directory combination. If this logical name is not defined, the logical HSM\$MANAGER is used instead. The staging area is cleaned up after a repack operation.

#### 5.13.1 Repack Performance

The repack operation, especially on tape volumes created under HSM V1.x, is likely to take several days to complete. While repacking is being performed, certain tape-oriented operations are suspended and queued to avoid conflicts. However, when HSM detects that a conflicting tape operation is pending, the repack operation is suspended temporarily, usually within 10 minutes, to allow the other operations to proceed. Therefore, despite the duration of the repack operation, other HSM operations will only suffer minor delays, and the long duration of repack should not be a concern.

### 5.14 Replacing and Creating Archive Classes

HSM provides a mechanism for replacing and/or creating new archive classes, and populating associated shelf media with valid data. You may wish to create a new archive class to provide additional data safety. More likely though, you may wish to create a new archive class to upgrade your tape hardware to new technology or move your shelved data to a new tape library.

Although HSM provides the reshelving function to accomplish this, this is slow and involves intermediate disk transfers. A much more efficient way is to use the REPACK function and specify a NEW\_ARCHIVE qualifier. When performing a repack for this purpose, you must not specify any volumes in the volume list, and no threshold value. It is important that all valid files are copied to the new archive class. However, the purging of obsolete files is still performed when creating a new archive class using repack.

The following example creates a new archive class:

```
$ SMU REPACK 1/TO_ARCHIVE=3/NOTHRESHOLD
```

This command creates a new archive class 3, using all valid data from archive class 1. Archive class 3 may be of a different media type than archive class 1.

### 5.15 Replacing A Lost or Damaged Shelf Volume

If you lose or damage a shelf tape, you will not be able to recover the data on that tape, and are at risk for not providing the level of data safety that HSM provides. As soon as you discover that a shelf tape has been lost or damaged, you should take steps to replace it by using REPACK to copy the contents of the tape, from another archive class, to new media.

When discovering the lost or damaged tape, you should determine which archive class it belonged to. Then issue a REPACK command specifying an alternate archive class that is or was defined for the shelf. When performing this operation, you should specify the volume to be replaced but no thresholds for the copy. However, as with all repack operations, obsolete files are not copied.

The following example replaces a lost or damaged shelf volume:

```
$ SMU REPACK 1/VOLUME=ACG001/FROM_ARCHIVE=2/NOTHRESHOLD
```

## Managing the HSM Environment

### 5.16 Catalog Analysis and Repair

This example replaces shelf volume ACG001 from archive class 1, using media from archive class 2. It may take several volumes from archive class 2 to replace the data in the volume. Also, the replacement volume will have a different label to ACG001, but its contents contain the valid replacement data for ACG001. If the archive class is not checkpointed after the operation, the replacement volume becomes the current shelving volume for the archive class, and will be filled up.

This function cannot be performed if only one archive class is specified for the shelf, which is not recommended for this very reason.

If you have a site disaster, and most or all of the media for an archive class are damaged, then you should create a new archive class as described in the previous section, rather than recover each volume individually.

## 5.16 Catalog Analysis and Repair

The ANALYZE/REPAIR utility is used to align the contents of the HSM catalog(s) with a disk that has been backed up and later restored, or has been renamed. It is also useful to run this utility if you suspect that any other discrepancies between the online disk state and the HSM catalog(s) may have occurred.

SMU ANALYZE will scan all files on a disk looking for shelved and preshelved files. When a file is found that is of interest, its HSM metadata (file header and ACE information) is compared against entries in the HSM catalog(s) and any discrepancies are reported. If the /REPAIR qualifier is used, the discrepancy can be repaired. If /CONFIRM is not used with /REPAIR, then the default repair action will be applied.

### Example of the ANALYZE Command With No /REPAIR

```
$ SMU ANALYZE DKB500
%SMU-I-PROCESSING, processing input device DKB500
%SMU-I- scanning for shelved files on disk volume _$1$DKB500:
File (14,1,0) "$1$DKB500:[ANALYZE_TEST]STATUS.RPT;1"
  Stored in catalog as:
    FID (13,1,0) "BOGUS$DEVICE1:[ANALYZE_TEST]STATUS.RPT;1"
  Invalid HSM metadata found for
File (15,1,0) "$1$DKB500:[ANALYZE_TEST]LOGIN.COM;1"
  Stored in catalog as:
    FID (12,1,0) "$1$DKB500:[ANALYZE_TEST]LOGIN.COM;1"
  Invalid HSM metadata found for
File (16,1,0) "$1$DKB500:[ANALYZE_TEST]Q4_RESULTS.TXT;1"
  No catalog entry found - file not repairable
  Invalid HSM metadata found for
File (17,1,0) "$1$DKB500:[ANALYZE_TEST]ANALYSIS.DAT;1"
File (18,1,0) "$1$DKB500:[ANALYZE_TEST]RECIPE.MEM;1"
  Revision date mismatch -
    Current: 9-JUL-1999 16:45:39.37
    Catalog: 10-JUL-1999 15:54:21.74
File (19,1,0) "$1$DKB500:[ANALYZE_TEST]MAIL.SAV;1"
  Stored in catalog as:
    FID (19,1,0) "BOGUS$DEVICE1:[ANALYZE_TEST]MAIL.SAV;1"
%SMU- completed scan for shelved files on disk volume _
%SMU-I-ERRORS, 6 error(s) detected, 0 error(s) repaired
```

### Example of the ANALYZE Command with Default Confirmation

```
$ SMU ANALYZE/REPAIR DKB500
%SMU-I-PROCESSING, processing input device DKB500
%SMU-I-scanning for shelved files on disk volume _$1$DKB500:
File (14,1,0) "$1$DKB500:[ANALYZE_TEST]STATUS.RPT;1"
  Stored in catalog as:
    FID (13,1,0) "BOGUS$DEVICE1:[ANALYZE_TEST]STATUS.RPT;1"
  File entry repaired - 1 repairs made.
  Invalid HSM metadata found for
File (15,1,0) "$1$DKB500:[ANALYZE_TEST]LOGIN.COM;1"
```

## Managing the HSM Environment

### 5.16 Catalog Analysis and Repair

```
Stored in catalog as:
FID (12,1,0) "$1$DKB500:[ANALYZE_TEST]LOGIN.COM;1"
File entry not repaired.
Invalid HSM metadata found for
File (16,1,0) "$1$DKB500:[ANALYZE_TEST]Q4_RESULTS.TXT;1"
No catalog entry found - file not repairable
Invalid HSM metadata found for
File (17,1,0) "$1$DKB500:[ANALYZE_TEST]ANALYSIS.DAT;1"
File entry repaired - 1 repairs made.
File (18,1,0) "$1$DKB500:[ANALYZE_TEST]RECIPE.MEM;1"
Revision date mismatch -
Current: 9-JUL-1999 16:45:39.37
Catalog: 10-JUL-1999 15:54:21.74
File entry repaired - 1 repairs made.
File (19,1,0) "$1$DKB500:[ANALYZE_TEST]MAIL.SAV;1"
Stored in catalog as:
FID (19,1,0) "BOGUS$DEVICE1:[ANALYZE_TEST]MAIL.SAV;1"
File entry repaired - 1 repairs made.
%SMU- completed scan for shelved files on disk volume _
%SMU-I-ERRORS, 6 error(s) detected, 4 error(s) repaired
```

#### Example of ANALYZE/REPAIR/CONFIRM

```
$ SMU ANALYZE/REPAIR/CONFIRM DKB500
%SMU-I-PROCESSING, processing input device DKB500
%SMU-I- scanning for shelved files on disk volume _$1$DKB500:
File (14,1,0) "$1$DKB500:[ANALYZE_TEST]STATUS.RPT;1" Stored in catalog as:
    FID (13,1,0) "BOGUS$DEVICE1:[ANALYZE_TEST]STATUS.RPT;1"
    ** Repair catalog entry to reset volume, FID to _ (14,1,0)? [Y]: N
    File entry not repaired.
    Invalid HSM metadata found for
    File (15,1,0) "$1$DKB500:[ANALYZE_TEST]LOGIN.COM;1"
    Stored in catalog as:
        FID (12,1,0) "$1$DKB500:[ANALYZE_TEST]LOGIN.COM;1"
        ** Repair catalog entry to reset FID to (15,1,0) ?
        ** WARNING: Repair may affect the wrong file - with caution [N]: Y
        File entry repaired - 1 repairs made.
    Invalid HSM metadata found for
    File (16,1,0) "$1$DKB500:[ANALYZE_TEST]Q4_RESULTS.TXT;1"
    No catalog entry found - file not repairable
    Invalid HSM metadata found for
    File (17,1,0) "$1$DKB500:[ANALYZE_TEST]ANALYSIS.DAT;1"
    ** Repair by adding HSM metadata for file (17,1,0) ? [Y]:
    File entry repaired - 1 repairs made.
    File (18,1,0) "$1$DKB500:[ANALYZE_TEST]RECIPE.MEM;1"
    Revision date mismatch -
    Current: 9-JUL-1999 18:29:09.96
    Catalog: 10-JUL-1999 17:37:52.33
    ** Repair by deleting HSM metadata for file (18,1,0) ? [Y]: Y
    File entry repaired - 1 repairs made.
    File (19,1,0) "$1$DKB500:[ANALYZE_TEST]MAIL.SAV;1"
    Stored in catalog as:
        FID (19,1,0) "BOGUS$DEVICE1:[ANALYZE_TEST]MAIL.SAV;1"
        ** Repair catalog entry to reset volume to _ ? [Y]: Y
    File entry repaired - 1 repairs made.
%SMU- completed scan for shelved files on disk volume _
%SMU-I-ERRORS, 6 error(s) detected, 4 error(s) repaired
```

#### Example of ANALYZE/REPAIR/CONFIRM/OUTPUT

```
$ SMU ANALYZE/REPAIR/CONFIRM/OUTPUT=ANALYZE.OUT DKB500
File (14,1,0) "$1$DKB500:[ANALYZE_TEST]STATUS.RPT;1"
Stored in catalog as:
FID (13,1,0) "BOGUS$DEVICE1:[ANALYZE_TEST]STATUS.RPT;1"
** Repair catalog entry to reset volume, FID to _ (14,1,0) ? [Y]: Y
File entry repaired - 1 repairs made.
Invalid HSM metadata found for File (15,1,0)
"$1$DKB500:[ANALYZE_TEST]LOGIN.COM;1"
Stored in catalog as:
FID (12,1,0) "$1$DKB500:[ANALYZE_TEST]LOGIN.COM;1"
** Repair catalog entry to reset FID to (15,1,0) ?
```

## Managing the HSM Environment

### 5.17 Consolidated Backup with HSM

```
** WARNING: Repair may affect the wrong file - with caution [N]: Y
File entry repaired - 1 repairs made.
Invalid HSM metadata found for
File (16,1,0) "$1$DKB500:[ANALYZE_TEST]Q4_RESULTS.TXT;1"
No catalog entry found - file not repairable
Invalid HSM metadata found for
File (17,1,0) "$1$DKB500:[ANALYZE_TEST]ANALYSIS.DAT;1"
** Repair by adding HSM metadata for file (17,1,0) ? [Y]:
File entry repaired - 1 repairs made.
File (18,1,0) "$1$DKB500:[ANALYZE_TEST]RECIPE.MEM;1"
Revision date mismatch - Current:9-JUL-1999 18:38:58.06
Catalog: 10-JUL-1999 17:47:40.42
** Repair by deleting HSM metadata for file (18,1,0) ? [Y]: Y
File entry repaired - 1 repairs made.
File (19,1,0) "$1$DKB500:[ANALYZE_TEST]MAIL.SAV;1"
Stored in catalog as:
FID (19,1,0) "BOGUS$DEVICE1:[ANALYZE_TEST]MAIL.SAV;1"
** Repair catalog entry to reset volume to _ ? [Y]: Y
File entry repaired - 1 repairs made.
$
$ TYPE ANALYZE.OUT
%SMU-I-PROCESSING, processing input device DKB500
%SMU-I- scanning for shelved files on disk volume _$1$DKB500:
File (14,1,0) "$1$DKB500:[ANALYZE_TEST]STATUS.RPT;1"
Stored in catalog as:
FID (13,1,0) "BOGUS$DEVICE1:[ANALYZE_TEST]STATUS.RPT;1"
File entry repaired - 1 repairs made.
Invalid HSM metadata found for File (15,1,0)
"$1$DKB500:[ANALYZE_TEST]LOGIN.COM;1"
Stored in catalog as:
FID (12,1,0) "$1$DKB500:[ANALYZE_TEST]LOGIN.COM;1"
File entry repaired - 1 repairs made.
Invalid HSM metadata found for
File (16,1,0) "$1$DKB500:[ANALYZE_TEST]Q4_RESULTS.TXT;1"
No catalog entry found - file not repairable
Invalid HSM metadata found for
File (17,1,0) "$1$DKB500:[ANALYZE_TEST]ANALYSIS.DAT;1"
File entry repaired - 1 repairs made.
File (18,1,0) "$1$DKB500:[ANALYZE_TEST]RECIPE.MEM;1"
Revision date mismatch - Current: 9-JUL-1999 18:38:58.06
Catalog: 10-JUL-1999 17:47:40.42
File entry repaired - 1 repairs made.
File (19,1,0) "$1$DKB500:[ANALYZE_TEST]MAIL.SAV;1"
Stored in catalog as:
FID (19,1,0) "BOGUS$DEVICE1:[ANALYZE_TEST]MAIL.SAV;1"
File entry repaired - 1 repairs made.
%SMU- completed scan for shelved files on disk volume -
%SMU-I-ERRORS, 6 error(s) detected, 5 error(s) repaired
```

## 5.17 Consolidated Backup with HSM

HSM offers a paradigm to consolidate HSM shelf data with that required for backup/restore purposes. This paradigm is called *Consolidated Backup With HSM*, and is designed for use with very large sites where the number of tapes is problematic, or sites who are reaching the limit of their backup window. This paradigm is also known as Backup via shelving.

We refer to this as a paradigm, rather than an HSM function, because no special HSM functions are required; the paradigm is implemented using normal HSM and BACKUP (or SLS) commands. The paradigm consists of the following elements, which are described in subsequent sections:

- Setting up SLS to handle shelved and preshelved files if you are using SLS as your regular backup product
- Preshelving most files on the system
- Backing up only the headers of shelved and preshelved files in both image and incremental backups

- Restoring disks and files with files being restored in the shelved state
- File-faulting file data as it is needed, or unshelving recently-accessed files
- Repacking shelf tapes regularly

To implement this paradigm, HSM has provided a special version of BACKUP, called HSM\$BACKUP, with this release. This version allows backing up only the headers of preshelved and shelved files, and in the shelved state. It is expected that this functionality will be incorporated into a future version of OpenVMS BACKUP.

### 5.17.1 Setting up SLS

If you are using SLS as your regular BACKUP product, you need to configure SLS to use the new HSM\$BACKUP image for your regular backups. This feature is supported only with SLS V2.8 or later.

The steps you need to take are:

- Defining a logical name to reference HSM\$BACKUP
- Changing the SBK files to handle shelved and preshelved files
- Optionally adding qualifiers to manual system backups
- Optionally adding qualifiers to user backups

You set up SLS to use HSM\$BACKUP by defining the following logical name:

```
$ DEFINE /TABLE=LNM$SLS$VALUES SLS$HSM_BACKUP 1
```

Depending on the type of backups or restores you are performing, you may want to include the new /[NO]SHELVED and /[NO]PRESHELVED qualifiers (as described in Section 5.17.3) in the following cases:

- In the SBK files for regular system backups
- In the Manual System Backup screen (from the SLSOPER menu) for special system backups
- In the /QUALIFIERS qualifier in the STORAGE SAVE command

This paradigm is not yet supported for Archive/Backup System (ABS).

### 5.17.2 Preshelving Files

The key to this paradigm is preshelving most files on the system. From HSM V2.0, preshelved files have a unique state, and are flagged as preshelved in the file header. Since the data of a preshelved file remains online, the file can be modified at any time. If a preshelved file is modified, extended, or truncated, a new HSM function changes the file from preshelved to unshelved. Also, in V2.0 and later, the eligibility for preshelving files is the same as shelved file, and the following types of files cannot be preshelved:

- Open files
- Directory files
- Files beginning with HSM\$
- Files marked /NOSHELVABLE
- Files marked /NOMOVE
- Files on disks with shelving disabled
- Bad files

## Managing the HSM Environment

### 5.17 Consolidated Backup with HSM

- Empty files

However, all other files (except those on system disks) can and should be preshelled to utilize this paradigm. This can be done in two ways:

```
$!  
$! This sets up a preshelve policy to regularly execute on all  
$! affected volumes on a regular basis:  
$!  
$ SMU SET POLICY policy_name /PRESHELVE /NOELAPSED /LOWWATER_MARK=0  
$ SMU SET SCHEDULE volume_list policy_name/AFTER=time  
$!  
$! This manually preshelves all files on a volume; this command may  
$! be placed in an HSM policy script file.  
$! $ PRESHELVE volume:[000000...]*.*;*
```

HSM will not preshelve files that are already preshelled or shelved, so these commands affect only files that have been created or modified since the last preshelve operation. Since HSM does not preshelve open files, you can perform the preshelling during the day.

When starting this paradigm up for the first time, however, thousands of files per volume will be preshelled, so it is recommended that only one volume at a time is processed during this startup phase.

#### 5.17.3 Nightly Backups

While using this paradigm, it is still necessary to perform regularly (for example, nightly) backups using your regular backup regimen. This is required to restore a disk's index file and directory structure following a disk failure.

For this paradigm to work, you must use "HSM\$BACKUP" as provided with the HSM kit as your backup engine. This backup engine can be supported by SLS. The paradigm substantially reduces the backup window because only the 512-byte header for each preshelled file is backed up: the data is stored in the HSM subsystem.

The recommended paradigm for regular backups is:

- A regular (for example, weekly/monthly) image backup
- A more regular (for example, nightly) incremental backup

Two new qualifiers are provided to HSM\$BACKUP to implement this paradigm:

- /NOPRESHELVED - NOPRESHELVED backs up only the headers of preshelled files; should be applied to image and incremental backup commands. /PRESHELVED (the default) backs up the data of preshelled files.
- /NOSHELVED - NOSHELVED backs up only the headers of shelved files; should be applied to incremental backups only. SHELVED causes a file fault and backs up the data of formerly shelved, now unshelved files. IMAGE backup always backs up only the headers of shelved files.

## Managing the HSM Environment

### 5.17 Consolidated Backup with HSM

The following examples contain the recommended options for performing image and incremental backups using this paradigm:

```
$!  
$! Image BACKUP  
$!  
$ HSM$BACKUP/IMAGE/IGNORE=INTERLOCK/RECORD/LOG/NOPRESHELVED -  
_ $ volume: device:saveset/SAVESET  
$!  
$! Incremental BACKUP  
$!  
$ HSM$BACKUP/RECORD/SINCE=BACKUP/NOPRESHELVED/NOSHELVED/LOG/ IGNORE=INTER-  
LOCK  
_ $ volume: device:saveset/SAVESET  
$!
```

Each of these commands backs up only the headers of shelved and preshelved files, and they are copied to the backup saveset in the shelved state. The online state remains unchanged.

#### 5.17.4 Restoring Volumes

If there becomes a need to restore a disk volume because it has become damaged, the normal restoration process is follows, namely:

- Restore the last image backup
- Use BACKUP/INCREMENTAL to restore incremental BACKUP in *reverse chronological order*

After applying the image and incremental backups, you have restored all the metadata and directory structure for the volume, and also have restored most of the files to the shelved state (that is, all files that were preshelved and shelved during the backup are restored to the shelved state). You can use either HSM\$BACKUP or normal OpenVMS Backup for the restore process.

Before making the volume available to users, it is necessary to repair the HSM catalog, since the file identifiers (FIDs) of shelved and preshelved files may have changed. You can repair them with the following command, which will take several minutes to run:

```
$ SMU ANALYZE/REPAIR volume:
```

Note that this operation completes successfully if you restore the files to the same volume (device name) or to a different device.

Once this command completes, the disk volume is ready for use. Note, however, that most files are still shelved. If you wish to avoid file faults on first file access on recently-accessed files,

you may want to initiate an unshelve procedure such as the following:

```
$ UNSHELVE volume:[000000...]*.*;*/SINCE=10-OCT-1999/EXPIRED
```

This command unshelves all files that have been accessed since 10-OCT-1999 (assuming you have enabled volume retention as recommended). The use of this command is optional.

#### 5.17.5 Restoring Files

You restore individual files by locating the volume that has the latest (or desired) copy of the file and restoring the file in the usual way. If, however, the file is restored in the shelved state, you should run the SMU ANALYZE/REPAIR command to reset its file identifier in the catalog.

## Managing the HSM Environment

### 5.18 Determining Cache Usage

#### 5.17.6 Repacking

Since you are using HSM as the repository of virtually all files on your system, the number of HSM media is liable to become very large. In order to keep this under control, it is recommended that you repack your archive classes regularly. Once every three-six months is recommended in such an environment. See section 7.14 for information on repacking archive classes.

#### 5.17.7 Other Recommendations

You should not use consolidated backup with HSM on system disks. Preshelving files on system disks (and having them restored in the shelved state) will likely result in an inability to reboot your system. This is highly unrecommended.

Also, you should define multiple shelves and multiple catalogs for this environment. The catalogs should be stored on shadowed disks with preshelving disabled. You should not preshelve any HSM-internal files, otherwise unshelving may not be possible after a restore.

## 5.18 Determining Cache Usage

If you wish to see how many files and blocks are being used for a cache device, you can enter a DIRECTORY command for the cache directory. For each cache device defined using SMU, the cache directory is located at device:[HSM\_CACHE]. To determine usage, enter a command as shown in the following example:

```
$ DIRECTORY/GRAND/SIZE=ALL $1$DKA100:[HSM_CACHE]
Grand total of 1 directory, 221 files, 9021/9021 blocks.
```

## 5.19 Maintaining File Headers

Because HSM keeps file headers in online storage while moving the file data to shelf storage, you need to consider your system limits for the number of file headers that can be on a given volume. If you exceed the allowable number of file headers on a given volume, users may see INDEXFILEFULL and HEADERFULL errors when creating files. To prevent this problem, you need to understand how OpenVMS limits the number of file headers on your disk and how you can control this information.

### 5.19.1 Determining File Header Limit

OpenVMS limits the number of file headers you can have on a volume by calculating a value for MAXIMUM\_FILES, using the following equation:

$$\text{MAXIMUM\_FILES} = \text{maxblock} / (\text{cluster\_factor} + 1)$$

Where maxblock is the value for "total blocks" from SHOW DEVICE/FULL and cluster\_factor must be between:

Min value: maxblock / (255 \* 4096) (or 1 whichever is greater)  
Max value: maxblock / 100

Many systems use the default value for cluster\_factor, which is 3 for disks whose capacity is greater than or equal to 50,000 blocks. Occasionally, you may have a problem with very large disks when the default value of three does not work and you need to calculate the minimum value using the equation. For additional information, see the INITIALIZE command in the OpenVMS DCL Dictionary.

By default, MAXIMUM\_FILES is (maxblock / ((cluster\_factor + 1) \* 2)), which is half of the actual maximum.



### 5.19.2 Specifying a Volume's File Headers

To initialize a volume with the greatest number of file headers possible, use the following DCL command:

```
$ INITIALIZE {device} {label}/CLUSTER = (maxblock/(255*4096)) -  
/MAXIMUM_FILES = (maxblock/(cluster + 1)) -  
/HEADERS = (maxblock/(cluster + 1))
```

If you initialize a volume with the largest number of file headers, the index file will be very large, and none of that space can be used for anything but file headers. This is not necessarily nor desirable, because you end up using approximately 25 percent of your disk space for file meta-data. In reality, you probably want to set aside about 1 percent of your disk space for file meta-data.

Note in the INITIALIZE command that /MAXIMUM\_FILES reserves space for the index file while /HEADERS allocates space for the index file. Using the /HEADERS qualifier is the only way to guarantee you can create that many files. Once initialized, you cannot ever have more files on the disk than the value given with the MAXIMUM\_FILES qualifier.

### 5.19.3 Extending the Index File

If you do not initialize your volumes using the /HEADERS qualifier, the file system will extend INDEXF.SYS for you as it needs file headers. The file system will not allow INDEXF.SYS to become multiheadered, which means you can have a maximum of approximately 77 extents in the header before you will get an error saying the index file is full.

You can tell how close you are to the index file limit using DUMP/HEADER/BLOCK=COUNT=0 [000000]INDEXF.SYS. The display contains a field called "Map area words in use." This field has a maximum of 155 for INDEXF.SYS. If the number of mapping words in use is around 120 to 130, you should schedule an image backup/restore cycle for the volume.

### 5.19.4 Maintaining the Number of File Headers

To prevent your system from reaching its file header limit, make sure you delete file headers as appropriate. What this means is, when you no longer need a file, do not leave it shelved with the file header on disk. Use another strategy to archive the file, just in case you need it someday. Then, delete the file from the disk.

## 5.20 Event Logging

HSM provides a comprehensive set of event logging capabilities that you can use to analyze shelving activity on your cluster and tune your system to provide an optimal computational environment.

Two types of logging are supported:

- Audit logging, which logs every visible operation in the system, its source, and its status.
- Error logging, which logs "unexpected" errors in HSM operation, with complete details of the requested operation and the error.

Event logging is supported by both the shelf handler process and the policy execution process. You can use the shelf handler log to obtain a complete summary of all shelving operations initiated on the cluster. You can use the policy log to obtain information relating to all policies run on the system.

Logging may be enabled or disabled at your discretion with one or more of the following selections: AUDIT, ERROR, and EXCEPTION.

## Managing the HSM Environment

### 5.20 Event Logging

#### 5.20.1 Accessing the Logs

The event logs are human-readable and can be displayed with the TYPE command while HSM is in operation. Access to the logs require SYSPRV, READALL, or BYPASS privileges. Table 5-5 lists their locations.

**Table 5-5 HSM Event Logging**

Description	Location
Shelf Handler Audit Log	HSM\$LOG:HSM\$SHP_AUDIT.LOG
Shelf Handler Error Log	HSM\$LOG:HSM\$SHP_ERROR.LOG
Policy Audit Log	HSM\$LOG:HSM\$PEP_AUDIT.LOG
Policy Error Log	HSM\$LOG:HSM\$PEP_ERROR.LOG

You can read the event logs at any time during HSM operation, using a TYPE command, a SEARCH command, or other OpenVMS read\_only tools. You also can obtain a dynamic output of events by issuing the following command on any of the event log files:

```
$ TYPE/TAIL/INTERVAL=1/CONTINUOUS HSM$LOG:log_file_name.LOG
```

The logs grow with use, and are not re-created on HSM startup. If you wish to reinitialize the logs, you can do so with the SMU SET FACILITY/RESET command, which opens a new version of each log file. The old files can then be purged, renamed and shelved, or otherwise disposed of to make space available.

Internally generated HSM requests are generally not reported in the audit log, as these are not visible to either the user or the system manager. However, they may be reported in the error log if they fail. Such internal requests include:

- Information requests, upon an OPEN operation of a shelved file
- Delete requests, upon a DELETE operation of a shelved file
- File flush requests, an individual request to flush a cache file to shelf storage
- SMU SHOW REQUESTS and SHOW VERSION requests

If you wish to see the "invisible" requests logged in the audit log, as well as shelf server logging of requests, you can enable the following logical name:

```
$ DEFINE/SYSTEM HSM$SHP_REMOTE_AUDIT 1
```

Please note that this will more than double the size of the audit log, and is only recommended when troubleshooting problems.

#### 5.20.2 Shelf Handler Log Entries

The shelf handler error log reports only requests that have not succeeded because of an unexpected error. It does not report all errors: for example, if an error occurs because of a user syntax error, or because of a valid but illogical HSM configuration, these are generally not reported in the error log.

If you see an entry in the error log, this means that it is worth investigating for more information. It does not necessarily mean that there is a problem with the HSM system, the hardware, or the media that contains the shelved file data. For more information on solving problems, see Chapter 7.

Each entry in the shelf handler log is tagged with a request number, which is incremented in the audit log. If a serious error occurs on a request, the request number in the audit log can be reconciled with the request number in the error log to obtain more information about the error.

The following are examples of audit and error log entries:

### Example of a Shelf Handler Audit Log Entry

```
Shelf handler V3.0A (BL22), Oct 20 1999 started at 22-
17:23:25.32 Shelf handler client enabled on node SYS001
29 20-OCT-1999 19:53:05.58, 22-SEP- 19:53:06.62: Status: Error
Application request from node SYS001, process 604003B9, user SMITH
Shelve file $1$DKA100:[SMITH]TESTJLM.DAT;1
30 20-OCT-1999 20:03:04.66, 22-SEP-
20:03:13.08: Status: Success
System request from node SYS002, process 40201C31, user SMITH
File fault (unshelve) file DISK$MYNODE:[SMITH]TESTJLM.DAT;1
31 20-OCT-1999 20:03:13.66, 20-OCT-
20:03:13.98: Status: Success
System request from node SYS002, process 40201C31, user SMITH
Unpreshelve file DISK$MYNODE:[SMITH]TESTJLM.DAT;1
```

### Example of a Policy Audit Log Entry

```
6648 20-OCT-1999 18:33:03.31, 20-OCT- 18:33:04.16 status: Success
Reset PEP logs request from node MYNODE, PID 20200687, user BAILEY
6649 20-OCT-1999 18:36:40.36, 22-SEP-
17:23:04.16 status: Success
Scheduled request from node MYNODE, PID 20200687, user SYSTEM
Reactive execution on volume _$1$DKA100:
Using policy definition HSM$DEFAULT_OCCUPANCY
Volume capacity is 5841360 blocks
Current utilization is 5286012 blocks
Lowwater mark is 90% or 5257224 blocks used
Primary policy definition Space Time Working Set(STWS) was executed.
Secondary policy definition Least Recently Used(LRU) was not executed.
A total of 1454 requests for 28867 blocks were successfully sent
To reach the lowwater mark 0 blocks must be reclaimed.
6650 20-OCT-1999 19:25:04.10, 22-SEP- 18:36:47.42 status: Success
Exceeded quota request from node MYNODE, PID 20200687, user SYSTEM
Reactive execution on volume _$1$DKA200:
Using policy definition HSM$DEFAULT_QUOTA
Quota capacity is 194865 blocks
Current utilization is 203416 blocks
Lowwater mark for UIC [107,34] is 80% or 155892 blocks used
Primary policy definition Space Time Working Set(STWS) was executed.
Secondary policy definition Least Recently Used(LRU) was not executed.
A total of 2051 requests for 48042 blocks were successfully sent
To reach the lowwater mark 0 blocks must be reclaimed.
```

### Example of a Shelf Handler Error Log Entry

```
*****
** 29 **          REQUEST ERROR REPORT
Error detected on request number 29 on node SYS001
Entry logged at 20-OCT-1999 19:53:06.86
** Request Information:
Identifier: 1
Process: 604003B9
Username: SMITH
Timestamp: 20-OCT-1999 19:53:05.58
Client Node: SYS001
Source: Application
Type: Shelve file
Flags: Nowait Notify
State: Original Validated
Status: Error
** Request Parameters:
```

## Managing the HSM Environment

### 5.21 Activity Logging

```
File:          $1$DKA100:[SMITH]TESTJLM.DAT;1
** Error Information:
%HSM-E- shelf access information unavailable for
$1$DKA100:[SMITH]TESTJLM.DAT;1
%SYSTEM-E-SHELFERROR, access to shelved file failed
** Request Disposition:
Non-fatal shelf handler error
Fatal request error
Operation was completed
** Exception Information:
Exception Module Line
SHP_NO_OFFLINE_INFO SHP_3851
Exception Module Line
SHP_INVALID_OFFLINE_INFOSHP_4015
```

### 5.21 Activity Logging

The event logs contain information that is logged at the end of each request, together with its final status. However, there is often a need to examine activity in progress for the following reasons:

- To monitor HSM activity
- To troubleshoot a problem
- To see what files are being shelved during a policy run
- To determine if an emergency termination of requests is necessary

To this end, HSM provides an SMU SHOW REQUESTS command that indicates the number of requests currently being processed. In addition, detailed information about requests can be dumped to an activity log on a SHOW REQUESTS/FULL command. The activity log is named:

```
HSM$LOG:HSM$SHP_ACTIVITY.LOG
```

A new version of the file is created for each SHOW REQUESTS /FULL command. The format of the activity log is similar to the shelf handler audit log, except that additional flags are displayed indicating the current state of the request.

In contrast to the event logs, which have clusterwide scope, the activity log is a node-specific log that reflects only the operations in progress on the requesting node. To accurately see activity on the entire cluster, you need to perform the SMU SHOW REQUESTS/FULL on every node in the cluster.

The following is an example of the activity log display:

```
** HSM Activity Log for Node MYNODE at 20-OCT-1999 16:37:06.67 **
1 20-OCT-1999 16:35:58.68, - Request in progress - Status: Null status
  System request from node MYNODE, process 20200B24, user BAILEY
  FileID Original Validated
  Free space of 100 blocks for user BAILEY on volume _$1$DKA100:
2 20-OCT-1999 16:35:15.46, - Request in progress - Status: Null status
  System request from node MYNODE, process 20200B24, user BAILEY
  FileID Original Validated
  Free space of 171 blocks for user BAILEY on volume _$1$DKA100:
3 20-OCT-1999 16:34:42.02, - Request in progress - Status: Null status
  Shelf request from node MYNODE, process 20200B26, user HSM$SERVER
  Original Validated
  Flush cache file _$1$DKA0:[HSM_CACHE]TEST2.DAT$7702292510;1 to shelf stor
  age
4 20-OCT-1999 16:34:42.01, - Request in progress - Status: Null status
  Shelf request from node MYNODE, process 20200B26, user HSM$SERVER
  Original Validated
  Flush cache file _$1$DKA0:[HSM_CACHE]TEST1.DAT$7702292519;3 to shelf stor
  age
```

## Managing the HSM Environment

### 5.22 Converting from Basic Mode to Plus Mode

In the activity log, requests are logged in reverse order of being received. Also, all active requests are logged, including internal requests that do not appear in the audit log.

#### Canceling Requests

If upon monitoring the activity log, or otherwise, you wish to cancel certain requests, there are several means to accomplish this. This is useful if a policy has started that is about to shelve files that you do not want to be shelved. Use the following table to determine how to cancel classes of requests:

**Table 5–6 Canceling Requests**

To Cancel...	Issue the Following Command...
All requests	SMU SET FACILITY/DISABLE=ALL
All shelve requests	SMU SET FACILITY/DISABLE=SHELVE
All unshelve requests	SMU SET FACILITY/DISABLE=UNSHELVE
All requests on a shelf	SMU SET SHELF name/DISABLE=ALL
Shelve requests on a shelf	SMU SET SHELF name/DISABLE=SHELVE
Unshelve requests on a shelf	SMU SET SHELF name/DISABLE=UNSHELVE
All requests on a volume	SMU SET VOLUME name/DISABLE=ALL
Shelve requests on a volume	SMU SET VOLUME name/DISABLE=SHELVE
Unshelve requests on a volume	SMU SET VOLUME name/DISABLE=UNSHELVE
Cache flushing	SMU_SET_FACILITY/DISABLE=SHELVE

Any request that is in operation may or may not complete. However, all pending requests are terminated with an "OPERATION DISABLED" message.

Once a managed entity is disabled, it must be reenabled for operations on that entity to resume.

## 5.22 Converting from Basic Mode to Plus Mode

Although you specify whether to install HSM Basic mode or HSM Plus mode during the installation process, you can convert to HSM Plus mode after the installation if you choose. To convert to HSM Plus mode, you need to do the following:

- Shut down the shelf handler.
- Disable the facility.
- Enter used tapes into MDMS volume database.
- Change to Plus mode.
- Restart the shelf handler.
- If you intend to use the same archive classes for Plus mode, you must CHECKPOINT the archive classes.
- Enable the facility.

## Managing the HSM Environment

### 5.22 Converting from Basic Mode to Plus Mode

---

#### Note

---

**Once you have shelved files in HSM Plus mode, you cannot go back to HSM Basic mode.**

---

The remainder of this section explains how to perform the conversion tasks in detail and provides recommendations that should make the transition easier.

#### 5.22.1 Shutting Down the Shelf Handler

To shut down the shelf handler, you use the SMU SHUTDOWN command. This command shuts down and disables HSM in an orderly manner. To use this command, you must have SYSPRV, TMPMBX, and WORLD privileges. If you do not shut down the shelf handler before you convert to Plus mode, the database could become corrupted and files may become ineligible for unshelving. Also, note that the mode change does not have effect until you restart HSM.

#### 5.22.2 Disabling the Shelving Facility

To disable the facility across the cluster, you use the SMU SET FACILITY command. You also use this same command, but with different qualifiers, to reenable the facility after the upgrade is completed. Disabling the facility prevents people from attempting to shelve or unshelve files while the conversion is in progress.

```
$ SMU SET FACILITY /DISABLE=ALL
```

#### 5.22.3 Entering Information for MDMS

To enable HSM Plus mode to access the appropriate information, you need to make MDMS aware of (tape) volumes that already have been used. For new shelving, you can use volumes already in the MDMS database.

For volumes that have already been used for HSM Basic mode, you need to allocate those volumes for unshelving purposes to HSM, bearing in mind the specific volume names used for HSM Basic mode. Because you need to use these volumes as "read-only" volumes, you may want to create a special volume pool for all the old HSM Basic mode volumes.

For more information on preparing HSM to work with MDMS, see the Getting Started with HSM Chapter of the HSM Installation and Configuration Guide.

#### 5.22.4 Changing from Basic Mode to Plus Mode

To change from HSM Basic mode to HSM Plus mode without reinstalling the HSM software, you need to change information about the facility and restart the shelf handler. Because HSM Version 3.0A converts existing HSM information upon installation, you do not need to do any additional conversion for HSM Plus mode to operate.

To change from HSM Basic mode to HSM Plus mode, use the following command:

```
$ SMU SET FACILITY /MODE=PLUS
```

#### 5.22.5 Restarting the Shelf Handler

Once you have made all the HSM Basic mode volumes known to MDMS and have reset the facility to HSM Plus mode, you are ready to restart HSM. To restart HSM, use the SMU STARTUP command.

### 5.22.6 Using the Same Archive Classes

If you intend to use the same archive classes for HSM Plus mode as you used for HSM Basic mode, you need to be very careful about the information that has been stored in those archive classes so far. To protect this information and enable HSM to use the same archive classes, you need to checkpoint the existing archive classes before you enable the facility for shelving in Plus mode.

The SMU CHECKPOINT command allows HSM to use the next volume in sequence for shelving operations within the archive class, but stops writing to the existing volumes for that archive class.

### 5.22.7 Enabling the Facility

The last thing you need to do for HSM Plus to start running is to enable the facility for shelving and unshelving operations, because you disabled it earlier. To do this, use the following command:

```
$ SMU SET FACILITY /ENABLE=ALL
```

### 5.22.8 Example Mode Conversion

The following is an example of a Basic mode configuration successfully converted to Plus mode. The Basic mode configuration consists of:

- One tape device used for HSM purposes (\$1\$MKA100:)
- Two archive classes (1 and 2), of media type CompactTape III, used for HSM
- Four volumes used in each archive class (HS0001 - HS0004 for archive class 1, and HS1001 - HS1004 for archive class 2) that have been used in Basic mode.

For the initial conversion to Plus mode, we will retain the same devices and archive classes for operation. Additional archive classes and devices can be added later in the usual way.

The following example shows the commands to issue to convert the above Basic mode configuration to Plus mode:

```
$!  
$! Convert HSM to Plus Mode (does not affect current operations)  
$!  
$ SMU SET FACILITY/MODE=PLUS  
$! Disable HSM shelving operations  
$!  
$ SMU SET FACILITY/DISABLE=ALL  
$!  
$! Shut Down HSM, and bring back up in Plus mode  
$!  
$ SMU SHUTDOWN  
$!  
$! Redefine the archive classes -  
$!   TK85K is a standard MDMS/SLS media type for "CompactTape III"  
$!   Pool TK85K_POOL is a pool for new volumes to be allocated in Plus mode  
$!  
$ SMU SET ARCHIVE 1,2 /MEDIA_TYPE=TK85K/ADD_POOL=TK85K_POOL  
$!  
$! If needed, define the HSM device in TAPESTART.COM, and restart  
$! MDMS/SLS. If the device is a magazine loader, additional configuration  
$! is necessary (see section 5.5.2 in the Guide to Operations).  
$!  
$!   MTYPE_1   := TK85K  
$!   DENS_1    :=  
$!   DRIVES_1  := $1$MKA100:  
$!  
$ @SYS$STARTUP:SLS$STARTUP.COM  
$!  
$! Define the Basic mode volumes in the MDMS/SLS Database, using a
```

## Managing the HSM Environment

### 5.22 Converting from Basic Mode to Plus Mode

```
$! specific pool called HSM_BASIC. This helps prevent these volumes being
$! allocated by another application.
$!
$ STORAGE ADD VOLUME HS0001/MEDIA_TYPE=TK85K/POOL=HSM_BASIC
$ STORAGE ADD VOLUME HS0002/MEDIA_TYPE=TK85K/POOL=HSM_BASIC
$ STORAGE ADD VOLUME HS0003/MEDIA_TYPE=TK85K/POOL=HSM_BASIC
$ STORAGE ADD VOLUME HS0004/MEDIA_TYPE=TK85K/POOL=HSM_BASIC
$ STORAGE ADD VOLUME HS1001/MEDIA_TYPE=TK85K/POOL=HSM_BASIC
$ STORAGE ADD VOLUME HS1002/MEDIA_TYPE=TK85K/POOL=HSM_BASIC
$ STORAGE ADD VOLUME HS1003/MEDIA_TYPE=TK85K/POOL=HSM_BASIC
$ STORAGE ADD VOLUME HS1004/MEDIA_TYPE=TK85K/POOL=HSM_BASIC
$!
$! Allocate the Basic mode volumes for HSM use.
$!
$ STORAGE ALLOCATE TK85K/VOLUME=HS0001/USER=HSM$SERVER
$ STORAGE ALLOCATE TK85K/VOLUME=HS0002/USER=HSM$SERVER
$ STORAGE ALLOCATE TK85K/VOLUME=HS0003/USER=HSM$SERVER
$ STORAGE ALLOCATE TK85K/VOLUME=HS0004/USER=HSM$SERVER
$ STORAGE ALLOCATE TK85K/VOLUME=HS1001/USER=HSM$SERVER
$ STORAGE ALLOCATE TK85K/VOLUME=HS1002/USER=HSM$SERVER
$ STORAGE ALLOCATE TK85K/VOLUME=HS1003/USER=HSM$SERVER
$ STORAGE ALLOCATE TK85K/VOLUME=HS1004/USER=HSM$SERVER
$!
$! Create a volume set for each archive class - all but the first
$! volume in an archive class MUST BE APPENDED to the first volume
$! in the archive class. Also, the given user name must be correct.
$!
$! NOTE THE ORDER OF COMMANDS - THIS IS SIGNIFICANT TO GET THE
$! CORRECT PROGRESSION OF VOLUMES IN THE ORDER:
$!           HSx001, HSx002, HSx003, HSx004
$!
$ STORAGE APPEND HS0001/VOLUME=HS0004/USER=HSM$SERVER
$ STORAGE APPEND HS0001/VOLUME=HS0003/USER=HSM$SERVER
$ STORAGE APPEND HS0001/VOLUME=HS0002/USER=HSM$SERVER
$ STORAGE APPEND HS1001/VOLUME=HS1004/USER=HSM$SERVER
$ STORAGE APPEND HS1001/VOLUME=HS1003/USER=HSM$SERVER
$ STORAGE APPEND HS1001/VOLUME=HS1002/USER=HSM$SERVER
$!
$! Define new volumes for the archive classes to use in Plus mode
$! (at least two per archive class).
$!
$ STORAGE ADD VOLUME DEC001/MEDIA_TYPE=TK85K/POOL=TK85K_POOL
$ STORAGE ADD VOLUME DEC002/MEDIA_TYPE=TK85K/POOL=TK85K_POOL
$ STORAGE ADD VOLUME DEC003/MEDIA_TYPE=TK85K/POOL=TK85K_POOL
$ STORAGE ADD VOLUME DEC004/MEDIA_TYPE=TK85K/POOL=TK85K_POOL
$!
$! Checkpoint the archive class to use new Plus mode volumes
$!
$ SMU CHECKPOINT 1,2
$!
$! Shut down HSM again
$!
$ SMU SHUTDOWN
$!
$! Restart HSM
$!
$ SMU STARTUP
$!
$! Enable HSM shelving operations
$!
$ SMU SET FACILITY/ENABLE=ALL
$!
```

At this point you can begin shelving files to the new volumes in Plus mode, as well as unshelve files from the previous volumes written in Basic mode.



---

## Operator Activities in the HSM Environment

This chapter provides information on operator activities in the HSM environment. It covers the following:

- Enabling and running the operator interface
- Loading and unloading single volumes for HSM Basic mode
- Responding to BACKUP requests for HSM Basic mode
- Working with magazine loaders for HSM Basic mode
- Working with automated loaders for HSM Plus mode
- Identifying typical operator messages

### 6.1 Enabling the Operator Interface

In most environments, HSM performs operations to nearline and offline storage devices. In many cases, manual loading and unloading of tape volumes and tape magazines are required. This section describes the messages that HSM issues to the OpenVMS OPCOM interface, and what the operator's possible options are.

When running HSM, the OPCOM operator interface must be enabled to allow the operator to perform such loading and unloading. To enable the operator interface, enter the following command:

```
$ REPLY/ENABLE=(CENTRAL, TAPES)
%%%%%%%%%%%% OPCOM 08-Apr-2002 14:25:46.05 %%%%%%%%%%%%%
Operator _SYS001$RTA2: has been enabled, username SYSTEM

%%%%%%%%%%%% OPCOM 08-Apr-2002 14:25:46.06 %%%%%%%%%%%%%
Operator status for operator _SYS001$RTA2:
CENTRAL, TAPES
```

### 6.2 Loading and Unloading Single Tapes for HSM Basic Mode

When an HSM operation is directed at a nonmagazine loader tape drive, the operator is responsible for loading and unloading tapes on the drive. The following messages apply to nonmagazine loader tape drives.

## Operator Activities in the HSM Environment

### 6.2 Loading and Unloading Single Tapes for HSM Basic Mode

#### 6.2.1 Load Volume, No Reply Needed

```
%%%%%%%%%% OPCOM 21-OCT-13:52:47.09 %%%%%%%%%%
Message from user HSM$SERVER on MYNODE
Please mount volume HSZ001 in device _ (no reply needed)
```

This request, issued by HSM, requests that you load a specific volume label into the specified drive.

Do not issue a REPLY to this message.

#### 6.2.2 Load Volume

```
%%%%%%%%%% OPCOM 21-OCT- 13:52:48.04 %%%%%%%%%%
Request 2324, from user HSM$SERVER on MYNODE
Please mount volume HSZ001 in device _ (OTHERNODE)
```

This request, issued by the OpenVMS mount command, requests that you load a specific volume label into the specified drive. Do one of the following:

- If the volume exists, load the requested volume into the drive.
- If the volume does not exist, load a scratch volume into the drive-the scratch volume can either have a blank label, or a label that is not in the HSM format.
- Enter a \$ REPLY/ABORT command to abort the operation.

If you load a volume into the drive, you can optionally reply with a confirmation:

```
$ REPLY/TO=2324
```

If you do not reply after loading a volume, the mount completes and HSM proceeds anyway.

#### 6.2.3 Reinitialize Volume

```
%%%%%%%%%% OPCOM 08_Apr-2002- 14:25:46.05 %%%%%%%%%%
Request 2324, from user HSM$SERVER on MYNODE
Allow HSM to reinitialize volume TEST to HS0001 in drive $1$MUA0:
NOTE: Previous contents of volume will be lost
```

This message is displayed if you loaded a volume with a different label than the one requested. Issue one of the following replies:

- REPLY/TO=message\_number if the volume can be safely re-initialized and used by HSM
- REPLY/ABORT=message\_number if the volume contains useful data and HSM cannot use it

This reply is required. HSM will not proceed until the request is answered with one of the possible replies.

#### 6.2.4 Volume Initialization Confirmation

```
%%%%%%%%%% OPCOM 30-MAY- 14:25:46.05 %%%%%%%%%%
Message from user HSM$SERVER on MYNODE
Volume in drive $1$MUA0: has been re-initialized to HS0001
Please place label HS0001 on volume when unloaded
```

This message is a confirmation that HSM has reinitialized a volume label. It serves as a reminder to place a physical volume label with the name listed in the message when the volume is unloaded.

Do not issue a REPLY to this message.

## Operator Activities in the HSM Environment

### 6.3 Responding to BACKUP Requests for HSM Basic Mode

#### 6.2.5 Unload Label Request

```
%%%%%%%%%% OPCOM 30-MAY- 14:25:46.05 %%%%%%%%%%
Message from user HSM$SERVER on MYNODE
Please place label HS0001 on volume unloaded from drive $1$MUA0:
```

This message is displayed when a tape volume, initialized by HSM, is unloaded from a drive. This is a final reminder to place the requested physical label on the tape volume, so that the volume can be located later. Do not issue a REPLY to this message.

### 6.3 Responding to BACKUP Requests for HSM Basic Mode

In addition to HSM-generated OPCOM requests, OpenVMS BACKUP also issues OPCOM messages when handling continuation volumes for HSM Basic mode. Please refer to the OpenVMS Utilities Manual: A - Z for information relating to BACKUP requests.

#### 6.4 Working with Magazine Loaders for HSM Basic Mode

HSM issues OPCOM messages to load and unload magazines into a magazine loader. The following requests are issued:

##### 6.4.1 Load Magazine

```
%%%%%%%%%% OPCOM 30-MAY- 14:25:46.05 %%%%%%%%%%
Request 3, from user HSM$SERVER on MYNODE
Please load magazine containing volume HS0001 into drive $1$MUA0:
```

This message requests that you load a specific magazine (stacker) into a magazine loader tape drive. The magazine itself is not identified, but the specific volume is identified. You should locate the magazine containing the specific volume, which should be labeled, and load that entire magazine into the magazine loader.

You should then enter one of the following:

- \$ REPLY/TO=message\_number if you successfully loaded the magazine
- \$ REPLY/ABORT=message\_number if you could not load the magazine for any reason

##### 6.4.2 Illegal Magazine

```
%%%%%%%%%% OPCOM 30-MAY- 14:25:46.05 %%%%%%%%%%
Message from user HSM$SERVER on MYNODE
The magazine loaded in drive $1$MUA0: has an invalid HSM configuration.
Please reconfigure magazine before reloading
See HSM Guide to Operations - Magazine Loaders
```

The magazine contains duplicate HSM volumes. Each HSM volume must have a unique label in the format HSyxxx, where y is the archive class minus 1, and xxx is a string in the format 001 - Z99. Please review the labels in the magazine, and initialize as appropriate. It is recommended that the labels in the magazine are ordered by archive class in ascending order. For example, HS0001, HS0002, HS1001, HS1002 etc.

Do not issue a REPLY to this message.

##### 6.4.3 Unload Magazine

```
%%%%%%%%%% OPCOM 30-MAY- 14:25:46.05 %%%%%%%%%%
Message from user HSM$SERVER on MYNODE
Please unload magazine from drive $1$MUA0:
```

This message requests that you unload the current magazine from the specified drive, and store it in its usual place.

Do not enter a REPLY to this message

## Operator Activities in the HSM Environment

### 6.5 Working with Automated Loaders for HSM Plus Mode

## 6.5 Working with Automated Loaders for HSM Plus Mode

If HSM needs to use a volume or a volume contained in a magazine that is not currently imported into the loader, there is a series of OPCOM requests and actions that need to occur for HSM to continue without failing.

### 6.5.1 Providing the Correct Magazine

The following series of operator actions and replies occur when HSM needs to use a volume contained in a magazine that is not imported into a loader.

1. HSM issues an OPCOM request asking for the volume to be loaded into the jukebox.

```
$
%%%%%%%%%%%% OPCOM 08-Apr-2002 15:28:59.72 %%%%%%%%%%%%%
Request 65514, from user HSM$SERVER on SLOPER
Please import volume AEL008 or its associated magazine into jukebox contain-
ing drive _SLOPER$MKA500:
```

2. The operator then tells MDMS to export the magazine currently in the loader.

```
$ STORAGE EXPORT MAGAZINE MAG002
```

3. MDMS then issues a message requesting that the magazine currently imported be removed from the jukebox and performs the logical export.

```
%%%%%%%%%%%% OPCOM 08-Apr-2002 15:30:15.76 %%%%%%%%%%%%%
Message from user SLS on SLOPER
Remove Magazine MAG002 from Tape Jukebox JUKEBOX1
%SLS-S-MAGVOLEXP, magazine volume AEL001 exported from tape jukebox
%SLS-S-MAGVOLEXP, magazine volume AEL002 exported from tape jukebox
%SLS-S-MAGVOLEXP, magazine volume AEL003 exported from tape jukebox
%SLS-S-MAGVOLEXP, magazine volume AEL004 exported from tape jukebox
%SLS-S-MAGVOLEXP, magazine volume AEL005 exported from tape jukebox
%SLS-S-MAGVOLEXP, magazine volume AEL006 exported from tape jukebox
%SLS-S-MAGVOLEXP, magazine volume AEL007 exported from tape jukebox
```

4. The operator then physically removes the magazine from the jukebox.

5. The operator then tells MDMS to import the magazine that contains the necessary volume.

```
$ STORAGE IMPORT MAGAZINE MAG001 JUKEBOX1
%%%%%%%%%%%% OPCOM 08-Apr-2002 15:30:51.38 %%%%%%%%%%%%%
Request 65515, from user SLS on SLOPER
Place Magazine MAG001 into Tape Jukebox JUKEBOX1; REPLY when DONE
```

6. The operator physically places the magazine into the jukebox.

7. Once the magazine is physically in the jukebox, the operator needs to reply to the OPCOM request to place the magazine in the jukebox. The operator's reply must come from another process besides the one that submitted the STORAGE IMPORT MAGAZINE command.

```
$ REPLY/TO=65515
15:31:08.27, request 65515 was completed by operator _SLOPER$FTA6:
```

8. MDMS then logically imports the volumes into the jukebox.

```
%SLS-S-MAGVOLIMP, magazine volume AEL008 imported into tape jukebox
%SLS-S-MAGVOLIMP, magazine volume AEL009 imported into tape jukebox
%SLS-S-MAGVOLIMP, magazine volume AEL010 imported into tape jukebox
%SLS-S-MAGVOLIMP, magazine volume AEL011 imported into tape jukebox
%SLS-S-MAGVOLIMP, magazine volume AEL012 imported into tape jukebox
%SLS-S-MAGVOLIMP, magazine volume AEL013 imported into tape jukebox
%SLS-S-MAGVOLIMP, magazine volume AEL014 imported into tape jukebox
```

9. At this point, the necessary volume is in the jukebox. The operator must then reply to the original OPCOM message requesting that the volume be placed into the jukebox.

```
$ REPLY/TO=65514 15:31:17.45, request 65514 was completed by operator
_SLOPER$FTA6:
```

## 6.5.2 Providing the Correct Volume for a TL820

The following series of operator actions and replies occur when HSM needs to use a volume that is not imported into a TL820 or similar device.

1. HSM issues an OPCOM request asking for the volume to be loaded into the jukebox.

```
$
%%%%%%%%%% OPCOM 08-Apr-2002 15:28:59.72 %%%%%%%%%%%
Request 65514, from user HSM$SERVER on SLOPER
Please import volume AWX001 or its associated magazine into jukebox contain-
ing
drive _SLOPER$MKA500:
```

2. The operator then issues the STORAGE IMPORT command. When the green light on the TL820 import goes on and an OPCOM message is issued requesting the load, the volume can be inserted into the import. The command must be issued first since MDMS controls access to the port door. The volume is physically inserted when MDMS asks for it.

```
$ STORAGE IMPORT CARTRIDGE AWX001 JUKEBOX1
```

3. MDMS then logically imports the volume into the jukebox.

```
%SLS-S-VOLIMP, volume AWX001 imported into tape jukebox
```

4. At this point, the necessary volume is in the jukebox. The operator must then reply to the OPCOM message requesting that the volume be placed into the jukebox.

```
$ REPLY/TO=65514 15:31:17.45, request 65514 was completed by operator
_SLOPER$FTA6:
```

## 6.6 Other MDMS Messages

OPCOM messages are provided in Plus mode when an attempt to select a drive for HSM operations fails. An example of the messages follows:

```
%%%%%%%%%% OPCOM 08-Apr-2002 12:01:23 %%%%%%%%%%%
Message from user HSM$SERVER on SYS001
MDMS/SLS error selecting a drive for volume DEC100, retrying
%%%%%%%%%% OPCOM 08-Apr-2002 12:01:24 %%%%%%%%%%%
Message from user HSM$SERVER on SYS001bad density specified for given media
type
```

Two messages are written as a pair: the first message is a constant message from HSM identifying the problem volume. The second message is the MDMS/SLS error code received from the call. Please note HSM does not consider a select failure as fatal, and retries the operation indefinitely. Please examine the OPCOM messages and correct the MDMS/SLS problem: refer to the Media, Device and Management Services Guide to Operations for help in determining the problem. You can also use the command \$ HELP STORAGE MESSAGE command for more information on specific MDMS/SLS messages for SLS /MDMS Versions prior to V2.6.

After the correction, HSM will proceed to process the requests normally. The OPCOM messages are repeated every 10 minutes if the select error continues to occur.

Another MDMS OPCOM message is printed if MDMS selects a drive for a tape volume, but cannot load the volume because it is already loaded in another drive.

## Operator Activities in the HSM Environment

### 6.7 Drive Selection and Reservation Messages for Both Modes

```
%%%%%%%%%% OPCOM 08-Apr-2002 12:01:23 %%%%%%%%%%%
Message from user HSM$SERVER on SYS001
Volume APW032 cannot be loaded into selected drive $1$MKA100:
Volume is loaded in another drive
Check volume location and drive availability, REPLY when corrected
```

This message should not normally happen, but if it does you should check the following:

- Determine whether another user (besides HSM) is using the volume. If so, you will need to wait until that user has finished with the volume and has deallocated the other drive. Then you can reply to the OPCOM message.
- If no other user has allocated a drive with this volume, check access to the other drive via STORAGE commands, MRU commands and/or OpenVMS MOUNT. If the volume cannot be accessed on the other drive, please follow corrective procedures by troubleshooting the hardware problem. When the volume is accessible, then reply to the OPCOM message.

In addition to the specific information given here about working with automated loaders, MDMS may display other messages that you need to respond to or deal with on versions prior to V2.6. For information about MDMS messages, see the MDMS online help.

```
$ HELP STORAGE messages
```

### 6.7 Drive Selection and Reservation Messages for Both Modes

The following OPCOM messages may be displayed when an error occurs trying to select and reserve a drive for HSM operations.

#### 6.7.1 Unavailable Drive

```
%%%%%%%%%% OPCOM 08-Apr-2002 12:01:23 %%%%%%%%%%%
Message from user HSM$SERVER on SYS001
Drive "name" has been marked unavailable and disabled -Please re-enable or
disable using SMU SET DEVICE name /ENABLE or /DISABLE
```

HSM has detected multiple errors while trying to use the drive, has assumed the drive to be bad, and has disabled operations on the drive. This message is repeated every 10 minutes until the operator enters one of the following commands:

- SMU SET DEVICE/DISABLED - This disables the device while possible repairs are made. Entering this command stops the OPCOM message from being displayed. While the device is disabled, alternative device(s) should be defined for HSM use.
- SMU SET DEVICE/ENABLED - This re-enables the device for use by HSM.

#### 6.7.2 Reservation Stalled

```
%%%%%%%%%% OPCOM 08-Apr-2002 12:01:23 %%%%%%%%%%%
Message from user HSM$SERVER on SYS001
Drive reservation for tape volume "name" stalled, retrying -
Optionally check drive availability and configuration
```

This message is an indication that a request for a tape drive is outstanding, and there are not enough drives available to handle the request. This could be because all defined drives are busy, or that a defined drive is disabled or otherwise cannot accept the request. Normally, no action is needed on this message, and the request is processed when a drive frees up. However, if this message persists for a long time, the operator should examine the HSM configuration and the drives to see if there is a problem.

### 6.7.3 Wrong Tape Label

```
%%%%%%%%%% OPCOM 30-MAY 12:01:23 %%%%%%%%%%%  
Message from user HSM$SERVER on SYS001  
Tape volume label on drive "name" detected  
Expected volume "right_name" but read "wrong_name"  
Please check volume and configuration
```

This message is displayed when HSM mounts the wrong tape for an operation. An accompanying message will be issued for non-robot tape devices to request a load of the correct volume to the specified drive.

## 6.8 Informational Operator Messages

The following OPCOM messages are printed out to log significant events in HSM operations. They are also logged in the shelf handler audit log.

### HSM Startup Message

```
%%%%%%%%%% OPCOM 6-JUN- 13:55:18.52 %%%%%%%%%%%  
Message from user HSM$SERVER on SYS001  
HSM shelving facility started on node SYS001
```

This message is printed out when HSM is started on a node via an SMU STARTUP command.

Do not issue a REPLY to this message.

### HSM Shelf Server Message

```
%%%%%%%%%% OPCOM 6-JUN- 13:55:18.39 %%%%%%%%%%%  
Message from user HSM$SERVER on SYS001  
HSM shelf server enabled on node SYS001
```

This message is printed out when an HSM shelf server becomes enabled on a certain node. This means that all tape operations are handled by this node from this point on. This message is printed out at startup of the server node or when a node takes over as the shelf server after a failure.

Do not issue a REPLY to this message.

### HSM Shutdown Message

```
%%%%%%%%%% OPCOM 6-JUN- 13:55:18.52 %%%%%%%%%%%  
Message from user HSM$SERVER on SYS001  
HSM shelving facility shutdown on node SYS001
```

This message indicates that HSM has been shut down with an SMU SHUTDOWN command.

Do not issue a REPLY to this message.

### HSM Termination Message

```
%%%%%%%%%% OPCOM 6-JUN- 13:55:18.52 %%%%%%%%%%%  
Message from user HSM$SERVER on SYS001  
HSM shelving facility terminated on node SYS001
```

This message indicates that HSM has terminated for some reason. It immediately follows any shutdown message. If it appears without a shutdown message, then an error occurred. Refer to the shelf handler error log to determine the cause of the error.

Do not issue a REPLY to this message.





---

# Solving Problems with HSM

This chapter explains how to identify and correct potential HSM problems.

## 7.1 Introduction to Troubleshooting

This chapter describes many of the common problems that can arise as a result of using HSM and lists appropriate solutions. The chapter is structured into the following sections:

- Introduction to Troubleshooting -Roadmap for locating appropriate log files, tools, and problem categories while troubleshooting a problem
- Troubleshooting Tools - An overview of HSM tools that you can use to diagnose and resolve problems
- Installation Problems - Problems that can arise when you install HSM
- HSM Startup Problems - Problems that can arise when you startup or shutdown HSM in a VMSccluster environment
- Mass Shelving Problems -The problem of unintentionally shelving a large number of files all at once, how to avoid this problem, and how to recover if it proceeds
- System Disk Shelving Problems - The potential problems associated with allowing files on the system disks to be shelved, and recovery solutions
- HSM Plus Mode (MDMS) Problems - Problems that HSM Plus mode may have that are actually MDMS problems
- VMSccluster Problems - Problems associated with running HSM on multiple nodes in a VMSccluster system
- Online Disk Problems - Problems associated with management of online disks in an HSM environment
- Cache Problems-Problems associated with the use of an online cache as a staging area or permanent shelf
- Magneto-Optical Device Problems - Problems associated with using magneto-optical devices
- Offline Device Problems - Problems associated with nearline or offline tape devices in an HSM environment
- Magazine Loader Problems for HSM Basic Mode - Problems associated with the various magazine loaders supported by HSM Basic mode, which may be dependent on the bus-architecture to which they are connected
- Robotic Device Problems for HSM Plus Mode - Problems associated with the various robotically-controlled devices supported by HSM Plus mode, which may be dependent on the bus-architecture to which they are connected

## Solving Problems with HSM

### 7.2 Troubleshooting Tools

- Shelving Problems - Problems associated with the shelving and preshelving operations in general
- Unshelving Problems - Problems associated with the unshelving and file fault operations in general
- Policy Problems - Problems associated with preventative and reactive policy execution, and policy tuning
- HSM System File Problems - Problems associated with the loss and corruptions of the system files that HSM uses for its operation
- HSM Limitations - Some limitations to the extent that HSM can be used on online volumes, and recovery actions if these limits are reached

The sections describing problems are in the following format:

- Problem category  
A problem category from the above list. Some problems may appear in several categories. Read the above list to help determine the category of the problem you are experiencing. Each problem category begins by describing the proper usage or configuration that can avoid the problem in the first place. In many instances, reading this section is enough to resolve the problem.
- A table of specific problems in the following format:  
  
Problem  
A description of symptoms and possible problems within the category.  
  
Solution  
The solution is usually a specific solution to fix the specific problem assuming that it is a problem. For example, the solution to the problem of not being able to shelve contiguous files is:  
  

```
SMU SET VOLUME /CONTIGUOUS.
```

  
However, before issuing this command, you should evaluate the advantages and disadvantages of shelving contiguous files.  
  
Reference  
A pointer to the section of the document that you should read for more details on the proposed solution.

Compaq recommends reading this chapter even if you have not experienced any problems. It can alert you to potential problems to avoid when setting up and using HSM.

## 7.2 Troubleshooting Tools

HSM provides several tools and utilities to help troubleshoot problems and resolve them as they occur. This section summarizes each tool and its purpose in troubleshooting.

### 7.2.1 Startup Logs

Two components of HSM have startup logs, which record the startup procedure and any failures for the shelf handler process and the policy execution process:

- HSM\$LOG:HSM\$\$SHELF\_HANDLER.LOG - Shelf handler process startup log
- HSM\$LOG:HSM\$\$SHELF\_PEP.LOG - Policy execution process startup log

If you have problems starting up HSM (using SMU STARTUP), examine these logs for more information. All messages to SYSS\$OUTPUT from the startup process and its subprocesses are written to this log. A new log file version is created for each startup event, and spans all nodes in the VMScluster system. You need to read the log to determine the node to which the log file refers.

Event Logs

### 7.2.2 After a problem occurs, the first things you should check are the event logs:

- HSM\$LOG:HSM\$SHP\_AUDIT.LOG-Shelf handler audit log
- HSM\$LOG:HSM\$SHP\_ERROR.LOG-Shelf handler error log
- HSM\$LOG:HSM\$PEP\_AUDIT.LOG-Policy execution audit log
- HSM\$LOG:HSM\$PEP\_ERROR.LOG-Policy execution error log

These logs report requests and errors, and have clusterwide scope. You should examine shelf handler logs first, as these cover all activities performed by HSM. All user-visible requests are reported in the shelf handler audit log, on both success and error.

If a problem occurs during the execution of a policy, whether scheduled preventative policy or reactive policy, you can obtain more details on the error and associated policy execution in the policy execution audit log. The policy audit log gives quite detailed information about the progress of the policy execution and is logged for all policy runs. The policy error log gives additional information if the policy failed because of an unexpected error. An error log entry is not written if a policy simply fails to reach its goal-this information is written in the audit log.

Please note that entries are placed in the event logs at the completion of a request. Requests in progress are not reported in the event logs, but rather in the activity log (see Section 7.2.3).

### 7.2.3 Activity Log

In contrast to the event logs, the activity log allows you to examine requests that are in progress. This is useful if you suspect that an operation is hung, or there are requests that have been generated that you wish to cancel (such as an unintended mass shelving). An activity log can be obtained using the SMU SHOW REQUESTS/FULL command, which dumps all in-progress requests to the file HSM\$LOG:HSM\$SHP\_ACTIVITY.LOG. Note that the activity log is node-specific.

The activity log is similar to the shelf handler audit log in format, except that the status and "completion time" are necessarily different. In addition, flags showing the input options and progress of the request also are displayed.

### 7.2.4 SMU LOCATE

If you are experiencing a problem in unshelving a shelved file's data, you can use the SMU LOCATE command to retrieve full information about the file's data locations. Although HSM tries to restore data from all known locations automatically, even when some of its metadata is missing, there may be occasions when this is not possible. In these situations, you should use the SMU LOCATE command to locate the file's data. Once you have found the data, you can restore it manually using BACKUP (from tape) or COPY (from cache) commands. SMU LOCATE reads the HSM catalog directly to find a shelved file's data locations.

You should note that the SMU LOCATE command does not work quite the same way as a typical OpenVMS commands when processing look-up and wildcard operations. The file name you supply as input (including any wildcards) applies to the file as stored in the HSM catalog at the time of shelving. Thus, for example:

- You may locate a shelved file by name, even if it has been deleted from the online system.

## Solving Problems with HSM

### 7.2 Troubleshooting Tools

- If the file has been renamed on the online system, you must use the old name (current at the time of shelving) to locate it.
- Alternatively, you can identify a file by file identifier, which together with a device name, uniquely identify a file, regardless of any renaming that may have been done after shelving.
- If you do not specify a device and/or directory in the SMU LOCATE command, it uses the default of `*:[000000...]*.*.*`.

When you retrieve information using the SMU LOCATE command, several instances or groups of stored locations may be displayed. These reflect the locations of the file when it was shelved at various stages of its life. You should carefully review the shelving time and revision time of the file to determine which, if any, is the appropriate copy to restore.

#### 7.2.5 UNSHELVE/OVERRIDE

When a shelved file is accessed causing a file fault, or when a request to unshelve a file is made, HSM performs consistency checking to validate that the shelved file data actually belongs to the file being requested. There are many such tests, including verification of the file identifier, device, and revision dates to ensure that the data being retrieved for the file is correct.

If any of the consistency checks fail, the file is not unshelved and the user-requested operations fail with an error message. As the system manager, you may be able to force unshelving of the file if some of these tests fail by using the UNSHELVE/OVERRIDE command, which requires BYPASS privilege. This tool enables you to retrieve important file data in the event that an unusual situation has occurred.

Compaq recommends that you examine the circumstances of the original consistency failure before using the UNSHELVE /OVERRIDE option. For example, use the SMU LOCATE command to verify the file revision dates. It is very likely that the data that you would restore is not exactly current, and additional recovery may be needed. Under no circumstances should UNSHELVE/OVERRIDE be used during normal operations (in policy scripts for example). The consistency failure indicates that HSM has detected a real problem that needs to be examined.

#### 7.2.6 SMU RANK

The SMU RANK command provides the capability of previewing an actual policy execution against a volume, before any files are actually shelved. This lists the names of all files that would be shelved if a policy were to be executed on a volume.

To avoid a mass shelving problem, Compaq recommends that you make extensive use of this command before enabling any automatic policy executions on a volume (see Section 7.5).

This command also can be used to tune your policies so that they select the correct files for shelving based on usage in your environment and that the quantity of files that they select is manageable.

#### 7.2.7 SMU SET and SHOW Commands

Many operational problems are caused by invalid or illogical configurations as set up using SMU commands. You can use the SMU SET and SHOW commands to determine if your configuration is valid and to make the configuration valid. The following are examples of common configuration problems that can easily be corrected using the SMU SET and SHOW commands:

- A shelf is defined with no archive classes.
- A shelf with archive classes has no devices that support those archive classes.
- Operations are disabled on the facility, the shelf, the device, the cache, or the volume for an operation.

- An archive class is supported by a device with an incompatible media type.
- A magneto-optical (MO) device is set up using the SMU SET DEVICE instead of the SMU SET CACHE command. MO devices are supported only as permanent shelves using the SMU SET CACHE commands.

See Chapter 3 for a tutorial in configuring HSM and the appendix in the Installation Guide for an example on how to set up a moderately complex configuration.

### 7.2.8 MDMS Tools for HSM Plus Mode

To verify the MDMS configuration and evaluate MDMS problems that affect HSM, use the following MDMS commands:

- STORAGE SHOW DRIVE
- STORAGE SHOW JUKEBOX
- STORAGE SHOW MAGAZINE
- STORAGE SHOW VOLUME
- STORAGE REPORT

For more information on these commands, see the Media, Device and Management Services for OpenVMS Guide to Operations.

## 7.3 Installation Problems

A number of problems can appear during the installation process. VMSINSTAL displays failure messages as they occur. If the installation fails, you see the following message:

```
%VMSINSTAL-E-INSFAIL, The installation of HSM V2.1 has failed.
```

Depending on the problem, you may see additional messages that identify the problem. Then, you can take appropriate action to correct the problem.

Sometimes, the problem does not show up until later in the installation process.

If the IVP fails, you see this message:

```
The HSM V2.1 Installation Verification Procedure failed.
```

```
%VMSINSTAL-E-IVPFAIL, The IVP for HSM V2.1 has failed.
```

Errors can occur during the installation if any of the following conditions exist:

- The operating system version is incorrect.
- Quotas necessary for successful installation are insufficient.
- System parameter values for successful installation are insufficient.
- The OpenVMS help library is currently in use.
- The product license has not been registered and loaded.
- HSM is currently running on at least one node in the cluster.

For descriptions of the error messages generated by these conditions, see the OpenVMS documentation on system messages, recovery procedures, and VMS software installation. If you are notified that any of these conditions exist, you should take the appropriate action as described in the message. For information on installation requirements, see Chapter 1 of the HSM Installation Guide.

## 7.4 HSM Startup Problems

This section describes problems that can occur while starting up HSM.

### 7.4.1 SMU Does Not Run

If you cannot run the Shelf Management Utility (SMU), examine Table 7-1 for more information.

---

**Note**

---

**In the reference column of a this table, IG refers to the HSM Installation Guide. When IG is not mentioned, assume that the reference is to this HSM Guide to Operations Manual.**

---

**Table 7-1 SMU Does Not Run**

<b>Problem</b>	<b>Solution</b>	<b>Reference</b>
HSM license not installed	Install the HSM License	IG Section 1.1.3
DECthreads images not installed	Install DECthreads images	IG Section 1.1.4
HSM logical names not defined	Define HSM\$CATALOG, HSM\$MANAGER, and HSM\$LOG	Section 2.11
Installation not complete	Complete installation	IG Section 1.3
Insufficient privilege	Check privileges in current account	IG Section 1.2.1

### 7.4.2 The Shelf Handler Does Not Start Up

If the shelf handler process (HSM\$\$SHELF\_HANDLER) does not start up, examine Table 7-2 and the following files for more information:

- HSM\$LOG:HSM\$\$SHELF\_HANDLER.LOG-Shelf handler startup log
- HSM\$LOG:HSM\$\$SHP\_ERROR.LOG-Shelf handler error log

---

**Note**

---

**In the reference column of a this table, IG refers to the HSM Installation Guide. When IG is not mentioned, assume that the reference is to this HSM Guide to Operations Manual**

---

**Table 7–2 The Shelf Handler Does Not Start Up**

<b>Problem</b>	<b>Solution</b>	<b>Reference</b>
HSM license not installed	Install the HSM License	IG Section 1.1.3
Catalog not created	Create a catalog	IG Section 1.4.2
SMU databases not created	Create databases; run SMU or HSM\$STARTUP.COM	
HSDRIVER not loaded	On VAX systems: SYSGEN CONNECT/NOADAPTER On Alpha systems:SYSMAN IO_CONNECT HSA0: /NOADAPTER	IG Section 1.4.1
HSM logical names not defined	Define HSM\$CATALOG, HSM\$MANAGER, and HSM\$LOG	Section 2.11
HSM logical names not system-wide	Use DEFINE/SYSTEM	Section 2.11
HSM logical names not same clusterwide	Use SYSMAN to define	Section 2.11
HSM logical names not correct	Check and redefine HSM\$CATALOG, HSM\$MANAGER, and HSM\$LOG	Section 2.11
Version limits on HSM\$LOG directory	Remove version limits from HSM\$LOG directory	Section 2.11
Shelf handler already started	Nothing	
Insufficient quotas	Increase quotas	IG Section 1.2.4
Insufficient privilege	Check and change HSM\$SERVER account V	IG Section 1.2.1
Insufficient disk space on HSM\$MANAGER HSM\$CATALOG, HSM\$LOG	Delete some files or redirect to another disk	
Request log corrupted	Delete HSM\$SHP_REQUEST*.SYS;* and restart	
SMU database corrupted	Delete HSM\$LOG:HSM\$*.SMU, recreate databases and restart; run SMU or HSM\$STARTUP.COM	
Catalog corrupted	Recover catalog from BACKUP copy and restart	Section 5.10.2
Installation not complete	Complete installation	IG Section 1.3
Shelf handler running in Basic mode after converting to Plus mode Verify all conversion steps performed especially SM	SMU SET FACILITY /MODE=PLUS	Section 5.22

## Solving Problems with HSM

### 7.4 HSM Startup Problems

#### 7.4.3 Policy Execution Process Does Not Start Up

If the shelf handler successfully starts up, but the policy execution process does not, examine Table 7-3 and the following files for more information:

- HSM\$LOG:SHELF\_PEP.LOG - Policy execution startup log
- HSM\$LOG:PEP\_ERROR.LOG - Policy execution error log

---

#### Note

**In the reference column of a this table, IG refers to the HSM Installation Guide. When IG is not mentioned, assume that the reference is to this HSM Guide to Operations Manual.**

---

**Table 7–3 Policy Execution Process Does Not Start Up**

Problem	Solution	Reference
Version limits on HSM\$LOG directory	Remove version limits from HSM\$LOG directory	
Policy execution process already started	Nothing	
Insufficient quotas	Increase quotas	IG Section 1.2.4
Insufficient privilege	Check and change HSM\$SERVER account privileges	IG Section 1.2.1
Insufficient disk space on HSM\$MANAGER, HSM\$LOG	Delete some files or redirect to another disk	
SMU database corrupted	Delete HSM\$LOG:HSM\$*.SMU, recreate databases and restart; run SMU or HSM\$STARTUP.COM	
Installation not complete	Complete installation	IG Section 1.3

#### 7.4.4 HSM Does Not Shut Down

If you have entered a SHUTDOWN command, but HSM does not shut down, and you have waited at least 30 seconds, examine Table 7-4 for more information.

**Table 7–4 HSM Does Not Shut Down**

Problem	Solution	Reference
HSM requests are in progress	SMU SHUTDOWN/NOW	
BACKUP operation is in progress	Wait 5 minutes- HSM does not exit if a BACKUP SAVE operation is in progress unless a 5 minute timeout expires: look for HSM\$SERVER_XX processes in SHOW SYSTEM to verify	
HSM is hung	Use SYSMAN DO SMU SHUTDOWN/FORCE on all nodes	



### 7.4.5 Shelving and SMU Commands Do Not Work

The following symptoms mean that parts of the HSM system are not running:

- Shelving and SMU commands hang.
- Shelving commands and SMU commands receive a shelf handler communications error message.
- The text unknown version appears on a component of the SMU SHOW VERSION command.

If the shelving driver is not loaded, issue the following command on OpenVMS VAX™ systems:

```
$ MCR SYSGEN CONNECT HSA0:/NOADAPTER
```

If the shelving driver is not loaded, issue the following command on OpenVMS Alpha™ systems:

```
$ MCR SYSMAN IO_CONNECT HSA0:/NOADAPTER
```

To recover any other component, issue the following command:

```
$ SMU STARTUP
```

## 7.5 Mass Shelving

Unintended mass shelving can occur when you enable OCCUPANCY, HIGHWATER\_MARK, and QUOTA operations on specific volumes, or the default volume, without careful preparation. Compaq recommends that you stage automatic shelving, one volume at a time, and in manageable quantities on those volumes by gradually lowering the volume's low water mark from its current occupancy level to the desired level.

You should not attempt to shelve more than 1000 files at a time, otherwise HSM's performance will degrade. Use the SMU RANK command to determine the quantity (and names) of files that would be shelved, before enabling the policy.

If you have accidentally initiated a mass shelving operation on a volume, use Table 7-5 to recover.

**Note**

**In the reference column of a this table, IG refers to the HSM Installation Guide. When IG is not mentioned, assume that the reference is to this HSM Guide to Operations Manual.**

**Table 7–5 Accidentally Starting Mass Shelving**

Problem	Solution	Reference
Cannot determine what would be shelved	Use SMU RANK	HSM Command Reference Guide
<b>Do not know what's being shelved</b>	<b>Use SMU SHOW REQUESTS/FULL</b>	<b>HSM Command Reference Guide</b>
Want to stop shelving on volume	Use SMU SET VOLUME /DIS-ABLE=SHELVE	

## Solving Problems with HSM

### 7.6 Shelving on System Disks

**Table 7–5 Accidentally Starting Mass Shelving**

Problem	Solution	Reference
Want to stop all shelving	Use SET FACILITY /DIS- ABLE=SHELVE	
Want to recover all shelved_files	Use UNSHELVE device:[000000...]*.*;*	

Additional options exist to cancel shelving operations at other granularities. See Table 5-6.

Note that once a shelving policy has begun, it is too late to simply disable the policy on the volume: SHELIVING must be disabled. However, it is a good idea to disable OCCUPANCY, HIGHWATER\_MARK, and EXCEEDED QUOTA on the volume, in case a trigger initiates another mass shelving on the volume.

## 7.6 Shelving on System Disks

### Warning

**Compaq strongly recommends that you do not enable shelving or any automatic shelving policies on system disks.**

Although the installation procedure marks OpenVMS system files as unshelvable, this could be enabled (intentionally or unintentionally) later. The installation procedure does not protect layered product files from shelving. You should define system disks separately from the HSM\$DEFAULT volume and disable all HSM operations, as in the following example:

```
$ SMU SET VOLUME SYS$SYSDEVICE:/DISABLE=ALL
```

Note that if there is more than one system disk in a VMScLuster system, the command should be issued on each node that has its own system disk. This especially applies to mixed VAX and Alpha VMScLuster systems.

If OpenVMS system or key layered product files are shelved, the consequences are that it may no longer be possible to boot any system in the VMScLuster environment. Specifically, if a file involved in the system startup stream is shelved, then accessed before HSM is started, the boot procedure will fail. Recovery may require a complete reinstallation of OpenVMS and affected layered products. It is much better to simply disable shelving on the system disks rather than to have to worry about all these consequences.

The procedures in Table 7-6 should be adopted to prevent or recover from this condition.

**Table 7–6 Shelving on System Disks**

Problem	Solution	Reference
Prevent shelving on system disks	SMU SET VOLUME system_disk: /DISABLE=ALL	
Prevent OpenVMS system files from being shelved	SET FILE disk:[directory_tree...]*.*;*/NO SHELVBABLE	
Recover if system cannot boot	Reinstall OpenVMS and affected layered products	

## 7.6.1 HSM Plus Mode (MDMS) Problems

There are a number of problems that HSM Plus mode may have that are not HSM problems, but are instead problems with MDMS. Many of these problems are related to MDMS configuration issues. For more information, see the Plus Mode Offline Environment Chapter of the HSM Installation and Configuration Guide and the Media, Device and Management Services for OpenVMS Guide to Operations.

---

**Note**

---

**In the reference column of a this table, IG refers to the HSM Installation Guide. When IG is not mentioned, assume that the reference is to this HSM Guide to Operations Manual unless otherwise specified.**

---

**Table 7–7 MDMS Problems**

Problem	Solution	Reference
No volumes are defined in the MDMS volume database for the volume pool HSM is using	Use the following HSM command to add new volumes to the volume pool \$ STORAGE ADD VOLUME 6 vol_name /POOL=pool_name or use the following command to add existing volumes to the volume pool: \$ STORAGE SET VOLUME vol_name /POOL=pool_name	Installation & Configuration Guide, Chapter
HSM is not authorized to access the volume pool.	Use the MDMS Administrator menu to authorize access to the volume pool	HSM Installation & Configuration Guide, Chapter 6
The media type specified for the archive class in HSM does not match any valid media type defined in TAPESTART.COM.	Look at TAPESTART.COM to find a valid media type definition. Use HSM \$ SMU SET ARCHIVE /MEDIA_TYPE=media_type to associate the appropriate media type with the archive class.	Installation & Configuration Guide, Chapter 6
MDMS is not running.	\$Use the following command to start up MDMS: @SYS\$STARTUP:SL\$STARTUP	MDMS Guide to Operations
HSM asks you to load volumes that are contained in a robotically controlled device	Check value for QUICKLOAD in TAPESTART.COM; - QUICKLOAD should be set to 1 to indicate the operator does not need to respond to requests to load volumes. Be sure all jukeboxes are defined correctly.	MDMS Guide to Operations

---

## 7.7 HSM VMScluster Problems

HSM is designed to run in a VMScluster environment. It must run on all nodes in the cluster so that files can be accessed from any node. The following requirements define how HSM must be run in a cluster environment for correct operation:

## Solving Problems with HSM

### 7.7 HSM VMScLuster Problems

- HSM must be started on all nodes in the VMScLuster system-it is recommended that HSM is started automatically in each node's startup procedure.
- The logical names HSM\$MANAGER, HSM\$LOG and HSM\$CATALOG must be defined as systemwide logical names with the same definition on all nodes in the VMScLuster system. Use SYSMAN with VMScLuster environment to define these logical names.
- All devices defined as cache devices, including magneto-optical disks, must be system-mounted and accessible from all nodes in the VMScLuster system.
- In Basic mode, tape devices must be accessible from all nodes enabled as shelf servers in the VMScLuster system. If no shelf servers are specified, the devices must be accessible from all nodes in the VMScLuster system.
- After installation, be sure to run HSM\$STARTUP.COM on all cluster nodes of the same architecture to install sharable images, define logical names, and correctly start up HSM. Using SMU STARTUP after an installation or upgrade of HSM is not sufficient on the first startup attempt.

If you are still having VMScLuster problems, examine Table 7-8 for more information.

---

#### Note

---

**In the reference column of this table, IG refers to the HSM Installation Guide. When IG is not mentioned, assume that the reference is to this HSM Guide to Operations Manual.**

---

**Table 7–8 HSM VMScluster Problems**

<b>Problem</b>	<b>Solution</b>	<b>Reference</b>
No control over shelf server node	SMU SET FACILITY /SERVER=node,	HSM Command Reference Guide
Shelf server node is unavailable	Specify alternate /multiple shelf server nodes	HSM Command Reference Guide
No failover after shelf server failure Verify that multiple nodes are defined as designated servers	HSM Command Reference Guide	
Cannot use cache disk on a node	System mount cache disk on the node	
Cannot use private cache disk on a visible node	All cache disks must be VMScluster	
Cannot access tape drive from a server node	All drives must be visible to all shelf server nodes	
Cannot locate a shelved file in catalog	Define HSM\$CATALOG with same definition on all nodes	IG Section 1.5
SMU database definitions different on nodes	Define HSM\$MANAGER with same definitions on all nodes	IG Section 1.5
Do not know which node is server	Search shelf handler audit log for last server startup	
No node comes up as server	Startup HSM on one or more defined server nodes	

## 7.8 Online Disk Problems

You can enable HSM operations on any or all of your online disks in the cluster as long as those disks are served and accessible to all nodes in the VMScluster system. HSM operations on purely local disks are not supported for HSM Version 2.2.

The online disks must be mounted and accessible to all nodes in the cluster. Any suitably privileged user can perform HSM operations on system-mounted disks. Access to group-mounted disks are subject to the same restrictions for HSM as normal operations. Process-mounted disks are ineligible for HSM operations.

HSM keeps a file open on all disks enabled for HSM operations: this file must be closed if the disk needs to be dismounted for any reason. To do this, enter the following commands:

- SMU SET VOLUME/DISABLE=ALL to close the file on the disk
- If the disk is an HSM cache disk, you also need to enter one of the following commands:
  - SMU SET CACHE/DELETE to close the file following a cache flush: this keeps the file open until the flush is complete, but maintains full access to shelved file data: the flush may take many minutes to complete.
  - SMU SET CACHE/DISABLE to close the file immediately: access to shelved file data in the cache is not possible while the disk is dismounted.

## Solving Problems with HSM

### 7.9 Cache Problems

Table 7-9 shows problems that can occur with online disks.

---

**Note**

---

**In the reference column of this table, IG refers to the HSM Installation Guide. When IG is not mentioned, assume that the reference is to this HSM Guide to Operations Manual.**

---

**Table 7-9 Online Disk Problems**

<b>Problem</b>	<b>Solution</b>	<b>Reference</b>
HSM operation is disabled on volume	SMU SET VOLUME/ENABLE=operation	HSM Command Reference Guide
Volume does not exist in SMU database	Use attributes of HSM\$DEFAULT_VOLUME	HSM Command Reference Guide
Unintended mass shelving started on volume	S MU SET VOLUME /DISABLE=SHELVE	Section 7.5
Cannot unshelve to local volume Use SMU LOCATE and retrieve the data manually	HSM Command Reference Guide	
Volume cannot be dismounted, open file	SMU SET VOLUME/DISABLE=ALL	HSM Command Reference Guide
Cache volume cannot be dismounted, open file	SMU SET CACHE /DISABLE	HSM Command Reference Guide
Device full on unshelve	Purge/delete/shelve some files, or run HSM policy, and retry.	
Exceeded quota on unshelve	Purge/delete/shelve some files of the same owner as the shelved file, or run HSM policy, and retry.	
Run out of file headers	There is an OpenVMS limit on the number of file headers available on a system. For more information, see Section 7.18.1.	
No HSM operations run, volume is mounted read-only	Mount volume read/write for any operation, even unshelving. Disable the volume for all HSM operations if it is mounted read-only.	
HSM operations hang, write-protect button pushed on disk	Reset write protect button. If you must write-protect the disk, the proper operations are: disable all HSM operations on volume, then mount the volume read-only.	

---

## 7.9 Cache Problems

The following problems are related to using an online cache. Unless you use the /BACKUP qualifier on the cache to create nearline/offline shelf copies at shelving time, your file data exists as a single copy on one of the defined cache devices until the cache is flushed. To ensure that this single copy provides the same level of protection as your online data, Compaq recommends the following:

- Configure your cache disk as a shadowed disk-this eliminates problems due to disk head crashes

## Solving Problems with HSM 7.10 Magneto-Optical Device Problems

- Back up your cache disk regularly-nightly is recommended
- Synchronize your nightly backups with cache flushing: flush the caches first, then perform nightly backups-in this way, the cache is usually empty

Table 7-10 shows problems that can occur with cache operations.

---

### Note

---

**In the reference column of this table, IG refers to the HSM Installation Guide. When IG is not mentioned, assume that the reference is to this HSM Guide to Operations Manual.**

---

**Table 7–10 Cache Problems**

Problem	Solution	Reference
Cache is not used on all nodes	Ensure cache device is visible and system-mounted on all nodes	
Cache disk is never used	Cache disks are filled to high water mark before switching to another cache	
Cache is not used: files go to tape	Cache disabled- enable the cache	HSM Command Reference Guide
Cache is not used: files go to tape	Cache is full-define additional cache disks or increase block size	HSM Command Reference Guide
Cache is not used: files go to tape	File is too large to fit in the cache- increase block size if needed	HSM Command Reference Guide
Cache gets device full Cache disk is full- define additional cache disks	HSM Command Reference Guide	
Cache is as slow as tape operation	Normal behavior with /BACKUP qualifier	HSM Command Reference Guide
Cache flush does not occur when cache high water mark is reached	Define a high water mark of less than 100%	HSM Command Reference Guide
Cache flush does not occur on schedule	See Offline Device Problems	Section 7.12

---

## 7.10 Magneto-Optical Device Problems

You can use magneto-optical devices in HSM by defining them as cache devices. As with other cache devices, each device must be accessible and system-mounted on all nodes in the VMScluster system. You can use magneto-optical devices in one of two ways:

- As a staging area prior to shelving to tape. Define the cache as /NOBACKUP with a /HIGHWATER\_MARK and /INTERVAL and /AFTER which enabled periodic cache flushing.
- As a permanent shelf. Define the cache with /BACKUP, with /HIGHWATER=100 and /NOINTERVAL to inhibit cache flushes.

## Solving Problems with HSM

### 7.11 Offline Device Problems

Each platter (or side of platter) that you wish to use as a cache must be defined with an SMU SET CACHE command, and system-mounted on all nodes in the VMScluster system. Use the logical device name of the mounted MO volume (JBxxx:) in the SET CACHE commands, not the name of the MO drives.

Table 7-11 shows problems that can occur with magneto-optical devices. See also cache problems in Section 7.10.

---

#### Note

---

**In the reference column of this table, IG refers to the HSM Installation Guide. When IG is not mentioned, assume that the reference is to this HSM Guide to Operations Manual.**

---

**Table 7–11 MO Device Problems**

Problem	Solution	Reference
MO devices do not work	Install and run OSMS V3.3 software	
Other problems	See Cache Problems	Section 7.10

## 7.11 Offline Device Problems

You can configure any number of nearline/offline devices for HSM use.

In Basic mode, nearline and offline devices must be accessible by all nodes in the VMScluster system designated as shelf servers, or all nodes in the VMScluster system if no servers are specified.

In Plus mode, you can use nearline and offline devices that are:

- On the VMScluster system, but not directly accessible to the shelf server
- On a VMScluster system that is physically remote from the shelf server through RDF and the SMU SET DEVICE/REMOTE command

Remote devices cannot be dedicated for HSM use.

Non-remote devices can be shared or dedicated for HSM use. If you set up a device for dedicated use, HSM will keep a tape mounted in the device at all times in anticipation of the next operation. With shared usage, HSM dismounts and unloads the device within one minute of the last operation.

Except when you are using nearline devices exclusively, tape operations are requested using OPCOM messages. You should enable OPCOM classes CENTRAL and TAPES at all times to respond to such messages.

Table 7-12 shows problems that can occur with offline devices.



## Solving Problems with HSM 7.12 Magazine and Robotic Loader Problems

---

### Note

---

**In the reference column of a this table, IG refers to the HSM Installation Guide. When IG is not mentioned, assume that the reference is to this HSM Guide to Operations Manual.**

---

**Table 7–12 Offline Device Problems**

Problem	Solution	Reference
Tape operations hang-device allocated to another user	Wait until other user dismounts tape, HSM will then proceed	
Tape operations hang-no OPCOM messages	Enable OPCOM classes CENTRAL and TAPES	
Tape operations hang-media offline or volume not software enabled	Put media online with online button; if this does not work, there may be a subsystem access error to the drive -see Release Notes	Release Notes
Device not selected on node (HSM Basic mode)	Ensure device is accessible from all server nodes, or specify server nodes and shutdown and restart HSM	
Device not released to other applications, device in use	SMU SET DEVICE /DIS-ABLE	HSM Command Reference Guide
Device not released to other applications, device not in use	SMU SET DEVICE/SHARE=operation	HSM Command Reference Guide
Tape operations are slow for online user	Use a cache	
Magazine loader problems	See Section 7.13	

---

## 7.12 Magazine and Robotic Loader Problems

HSM supports various types of Digital magazine loaders and robotically-controlled large tape jukeboxes for use as nearline shelf storage. Specific support varies depending on whether you are running HSM in Basic mode or Plus mode. You define these devices with SMU SET DEVICE commands as you would for any offline device and additional MDMS commands for HSM Plus mode. Table 7-13 shows problems that can occur with magazine or robotic loaders.

---

### Note

---

**In the reference column of a this table, IG refers to the HSM Installation Guide. When IG is not mentioned, assume that the reference is to this HSM Guide to Operations Manual.**

---

## Solving Problems with HSM

### 7.12 Magazine and Robotic Loader Problems

**Table 7–13 Loader Problems**

<b>Problem</b>	<b>Solution</b>	<b>Reference</b>
Tape requests hang	Ensure robot name is defined and connected to the appropriate driver	IG Section 1.4.4
Tape inventories are taken too often(Basic mode)	Do not switch volumes in magazines, the wrong magazine, or switch volumes between magazines	
Robot tape device not handled as robot in Basic Mode	Check that robot name is defined (Basic Mode in SMU device only)Robot Name definition.	
Robot tape device not handled as robot name in Plus Mode	Check that robot is defined correctly in MDMS TAPE-START.COM	HSM Installation & Configuration Guide, Chapter 6
SCSI robot device cannot be used when connected to SCSI bus	Connect robot name to GKDRIVER	IG Section 1.4.4
Loading does not work on DLT loaders	Ensure key position is in locked or system command position (key or square symbol)	
Load fault on magazine loader	Reset the loader, insert magazine with no volume in drive,HSM will continue	
HSM loses status, takes inventory of drive/magazine because of manual loading	Do not manually change magazines or load other volumes until HSM has completed operations and dismounted the volume in the drive (issue \$SHOW DEVICE)	
HSM does not unload volume after operations on shared device (Basic mode)	HSM dismounts the volume, but the unloading must be done manually or under control of another application	
Cannot use loader because HSM is using it	SMU SET DEVICE /DIS-ABLE	HSM Command Reference Guide
Other problems	See Section 7.12	

## 7.13 Shelving Problems

Table 7-14 describes generic shelving problems. These problems may additional to specific cache or device problems. Many of these problems also apply to preshelving.

**Table 7–14 Shelving Problems**

<b>Problem</b>	<b>Solution</b>	<b>Reference</b>
Cannot shelve, capacity license exceeded	Delete obsolete files or increase license capacity	
Shelving operation disabled on facility	SMU SET FACILITY /ENABLE=SHELVE	HSM Command Reference Guide
Shelving operation disabled on shelf	SMU SET SHELF /ENABLE=SHELVE	HSM Command Reference Guide
Shelving operation disabled on volume	SMU SET VOLUME/ENABLE=SHELVE	HSM Command Reference Guide
Cannot shelve file, insufficient privilege	Must have read and write access, GRPPRV or BYPASS privileges	
Cannot shelve file, ineligible file	SET FILE /SHELVABLE Certain types of file are always ineligible however	Section 5.5
Can shelve file, but want to disable	SET FILE/NOSHELVABLE	
Cannot shelve contiguous file	SMU SET VOLUME /CONTIGUOUS	HSM Command Reference Guide
Can shelve contiguous file, but want to disable	SMU SET VOLUME/NOCONTIGUOUS	HSM Command Reference Guide
Cannot shelve placed file	SMU SET VOLUME/PLACEMENT	HSM Command Reference Guide
Can shelve placed file, but want to disable	SMU SET VOLUME /NOPLACEMENT	HSM Command Reference Guide
Cannot shelve very large file	Files larger than 45% of disk capacity can never be shelved	
Cannot shelve file, volume ineligible	SMU SET VOLUME /ENABLE=SHELVE	HSM Command Reference Guide
Can shelve files on volume, but want to disable	SMU SET VOLUME/DISABLE=SHELVE	HSM Command Reference Guide
Cannot shelve files, no archive classes for shelf	SMU SET SHELF /ARCHIVE=n/RESTORE=n. If shelving to cache only, be sure that cache devices are defined and enabled.	HSM Command Reference Guide
Cannot shelve files, no devices defined for archive	SMU SET DEVICE /ARCHIVE=n	HSM Command Reference Guide
Ctrl/Y does not cancel shelve operation	SHELVE/CANCEL	HSM Command Reference Guide

## Solving Problems with HSM

### 7.14 Unshelving Problems

**Table 7–14 Shelving Problems**

<b>Problem</b>	<b>Solution</b>	<b>Reference</b>
Cache problems during shelving	See Section 7.10	
Offline device problems during shelving	See Section 7.12	
Magazine loader problems during shelving	See Section 7.13	

## 7.14 Unshelving Problems

Table 7-15 describes generic unshelving problems that are in addition to specific cache or device problems. Unshelving problems also apply to file faults.

**Table 7–15 Unshelving Problems**

<b>Problem</b>	<b>Solution</b>	<b>Reference</b>
Unshelving operation disabled on facility	SMU SET FACILITY /ENABLE=UNSHELVE	HSM Command Reference Guide
Unshelving operation disabled on shelf	SMU SET SHELF /ENABLE=UNSHELVE	HSM Command Reference Guide
Unshelving operation disabled on volume	SMU SET VOLUME /ENABLE=UNSHELVE	HSM Command Reference Guide
Cannot unshelve file, insufficient privilege	Must have read access, or GRP-PRV, READALL or BYPASS privilege	
Cannot unshelve file, inconsistent state	UNSHELVE/OVERRIDE, but use with caution	Section 7.2.5
Cannot unshelve file, access information lost	SMU LOCATE and manually recover	HSM Command Reference Guide
Cannot unshelve file, catalog or catalog entry missing	See Section 7.17	
Ctrl/Y does not cancel unshelve operation	UNSHELVE/CANCEL	HSM Command Reference Guide
Device full on unshelve	Purge/delete/shelve some files, or run HSM policy, and retry	
Exceeded quota on unshelve	Purge/delete/shelve some files of the same owner as the shelved file, or run HSM policy, and retry	
Cache problems during unshelving	See Section 7.10	
Offline device problems during unshelving	See Section 7.12	
Magazine loader problems during unshelving	See Section 7.13	

## 7.15 Policy Problems

HSM policies are designed to automatically shelve files based on triggers initiated by online disk events, high water marks, or scheduled operation. All problems with policies should first be examined by reading the following files:

- HSM\$LOG:HSM\$PEP\_AUDIT.LOG-Policy audit log
- HSM\$LOG:HSM\$PEP\_ERROR.LOG-Policy error log

In addition, details on specific policy runs can be found in the output file specified with SMU SET POLICY/OUTPUT.

Because policy runs usually involve shelving operations, please see also Section 7.14 if the shelving operations of the policy fail, rather than the policy itself.

Table 7-16 shows problems that can occur with policy execution.

## Solving Problems with HSM

### 7.15 Policy Problems

**Table 7–16 Policy Problems**

<b>Problem</b>	<b>Solution</b>	<b>Reference</b>
No policies will run, policy process not started	SMU STARTUP	HSM Command Reference Guide
Preventative policy defined, but never runs	SMU SET SCHEDULE	HSM Command Reference Guide
Policies shelve recently accessed files	SMU SET POLICY /ELAPSED	HSM Command Reference Guide
Reactive policy runs on system disk	SMU SET VOLUME /DISABLE=(OCC,HIGH,QUOTA)	HSM Command Reference Guide
Policy runs on wrong node	SET POLICY /SERVER=node	HSM Command Reference Guide
Selection based on read access does not work	SET VOLUME/RETENTION	
Policy does not reach low water mark	Selection criteria too narrow, broaden criteria	
Files are shelved, unshelved too often	Policy criteria not optimal, redefine criteria	
Nightly backups too long, unshelving occurs	Policy shelves files that have been modified during backup interval, redefine policy	
Unintended mass shelving on volume	See Section 7.5	
Users exceed disk capacity or quota even when HSM policies turned on	Decrease low water and/or high water mark	
Too many small files shelved	Use STWS algorithm or script	
Reactive policy does not shelve enough files	Decrease low water mark	
High water mark polling of 10 minutes is not frequent enough	Decrease high water mark	
Need to change HSM configuration before policy runs	Define additional policy to run a script to change configuration, and schedule before policy runs	
Policy does not shelve any files using expiration date	\$ SET VOLUME HSM /RETENTION=(1,-0-00:00:00.01)	Installation & Configuration Guide, Chapter 6

## 7.16 HSM System File Problems

HSM uses several files for its own purposes, and these files need to be carefully maintained. These files include:

- HSM\$CATALOG:HSM\$CATALOG.SYS (the HSM catalog)
- HSM\$MANAGER:HSM\$\*.SMU (the SMU databases)
- HSM\$MANAGER:HSM\$\$SHP\_REQUEST\*.SYS (the recovery logs)
- HSM\$MANAGER:HSM\$\$SHP\_DEVICE.DAT (the magazine loader database)
- HSM\$LOG:\*.LOG (the startup, event and activity logs)

It is imperative that the logical names associated with these files are defined on all nodes with the same definitions, so that HSM uses the same files on all nodes. It is also vital that the files contained within HSM\$CATALOG and HSM\$MANAGER are given the highest safety protection available, including:

- Shadowing the devices
- Backing up the HSM system files regularly

Specifically, the HSM catalog must be given the highest priority. An unrecoverable loss of the catalog will usually mean that you have lost access to all shelved file data, unless you have kept logs of locations of the data by regular SMU LOCATE commands, and stored them away.

Other restrictions include:

- Do not redefine any of these logical names while HSM is running. You can move the files and redefine the logical names while HSM is shut down, however.
- Do not delete any of these files while HSM is running. You can delete the recovery logs HSM\$\$SHP\_REQUEST\*.SYS while HSM is shut down, if you do not wish recovery to occur after startup: HSM automatically recreates the recovery logs on startup if they do not exist.
- Do not rename any of these files. You can, however, rename the directories while HSM is shut down, but never the file names.
- If these files are deleted or otherwise unavailable, you should shut down HSM, recover the files from a BACKUP copy, and restart HSM. Please note that any changes to the files since the last BACKUP interval will be lost.
- If the HSM catalog has to be recovered, the access information to files shelved since the last BACKUP copy will be lost.

Refer to Section 5.10 for more details about how to recover HSM system files.

## 7.17 HSM Limitations

At the current time, there are a few limitations to HSM operations of which you should be aware. These limitations are not necessarily the fault of HSM, but are instead reliant upon OpenVMS behaviors:

- Number of file headers available for an online disk volume
- Behavior of Ctrl/Y when a file fault occurs on an executable file
- Behavior of SET PROCESS/NOAUTO\_UNSHELVE across a network

## 7.17.1 OpenVMS Limit on File Headers

OpenVMS limits the number of file headers available for an online disk volume based on how the disk is initialized. As a result, as you shelve data and do not clean up your online disk, you could eventually exceed the number of file headers available.

To prevent this problem, make sure you delete file headers as appropriate. What this means is, when you no longer need a file, do not leave it shelved with the file header on disk. Use another strategy to archive the file, just in case you need it someday. Then, delete the file from the disk.

If you experience either `IDXFILEFULL` or `HEADERFULL` errors while trying to create files, you have exceeded the file header limit defined on your system. If you installed HSM on an existing system and have not specifically initialized your volumes for HSM use, you may not have planned for the additional number of files in `INDEXF.SYS` (the index file that contains the file headers for both online and shelved files). Also, you may not have preallocated space for the file headers using the `/HEADERS` qualifier on the disk initialization.

### **IDXFILEFULL Error**

If your users get `IDXFILEFULL` errors while trying to create files on the volume it means they are attempting to create more files than that specified on the `MAXIMUM_FILES` qualifier when the volume was initialized. There are two possible solutions to this:

- Delete unwanted files from the disk
- Perform an image backup of the disk, reinitialize the disk with a larger `MAXIMUM_FILES` value, then do an image restore operation specifying the `/NOINITIALIZE` qualifier on the `BACKUP` command line.

### **HEADERFULL Error**

If your users get a `HEADERFULL` error on `INDEXF.SYS` when creating files, it means the `INDEXF.SYS` file has reached its fragmentation limit. That is, adding one more file extent to `INDEXF.SYS` causes the "Map area words in use" field of `INDEXF.SYS`'s header to exceed 155. To solve this problem:

5. Perform an image backup of the disk.
6. Reinitialize the disk.
7. Perform an image restore of the disk.

The second step (reinitialize the disk) is not necessary unless you want to increase the `MAXIMUM_FILES` value of the disk or preallocate a larger `INDEXF.SYS` file (via `/HEADERS`). If you do reinitialize the disk, remember to use the `/NOINITIALIZE` qualifier on the backup command when restoring the disk.

## 7.17.2 Attempting to Cancel Execution of a Shelved File

When you attempt to execute (via a `RUN` command, for example) a shelved executable file, this causes a file fault. If you then try to cancel that execution, it does not. This occurs because OpenVMS does not actually allow you to cancel a DCL command using a `Ctrl/Y`. Normally, when you submit a DCL command that operates on data located online and type a `Ctrl/Y` to cancel it, the execution completes and then is canceled quickly enough that you do not notice.

## 7.17.3 Automatic Unshelving of Files across a Network

If you attempt to access a shelved file across a network but have set your process to `/NOAUTO_UNSHELVE`, the file is unshelved.



#### **7.17.4 Opening and Deleting RMS Indexed Files**

If you perform an RMS open of a shelved, indexed file, a file fault occurs, because some of the RMS metadata resides in the data section of the file. A file fault also occurs if you perform a DELETE/LOG of a shelved, indexed file; use DELETE/LOG with caution. DELETE/NOLOG works as expected.



---

## What is MDMS?

This chapter starts by describing the Media, Device and Management Services software (MDMS)' management concept and its implementation. Following that is a description of the product's internal interfaces.

---

### Note

**User interfaces are described in the following chapter.**

---

Media, Device and Management Services V4.0A (MDMS), can be used to manage locations of tape volumes in your IT environment. MDMS identifies all tape volumes by their volume label or ID. Volumes can be located in different places like tape drives or onsite locations. Requests can be made to MDMS for moving volumes between locations. If automated volume movement is possible - like in a jukebox (tape loader, tape library) - MDMS moves volume/s without human intervention. MDMS sends out operator messages if human intervention is required.

MDMS allows scheduled moves of volumes between onsite and offsite locations (e.g. vaults). Multiple nodes in a network can be setup as an MDMS domain. Note that:

- all nodes in a domain access one MDMS database
- all MDMS objects like volumes and drives are described in the MDMS database

MDMS is a client/server application. At a given time only one node in an MDMS domain will be serving user requests and accessing the database. This is the *database server*. All other MDMS servers (which are not the database server) are clients to the database server. All user requests will be delegated through the local MDMS server to the database server of the domain.

In case of failure of the designated database server, MDMS' automatic failover procedures ensure that any of the other nodes in the domain, that has the MDMS server running, can take over the role of the database server.

### 8.1 MDMS Objects

MDMS manages all information in its database as *objects*. Table 8-1 lists and describes the MDMS objects.

**Table 8-1 MDMS Object Records and What they Manage**

This Object Record...	Meets the Need to...
Domain	Manage domain-wide operating parameters. MDMS creates this object record automatically.
Node	Describe a node in the MDMS domain. It defines the node's network names. You cannot operate MDMS without Node object records.
Group	Group node object records. Groups are a convenient shortcut to specify a list of nodes.

## What is MDMS?

### 8.2 MDMS Interfaces

**Table 8–1 MDMS Object Records and What they Manage**

This Object Record...	Meets the Need to...
Location	Describe a location in your environment. A location can be the name of a building, a room or a facility.
Request	Handle all MDMS operations initiated by a user or an application.
Drive	Describe an OpenVMS drive to MDMS.
Jukebox	Describe a tape loader or tape library to MDMS.
Magazine	Describe a tape magazine to MDMS. The use of <i>magazine objects</i> , is optional even if magazines are used in reality.
Media Type	Describe the different media types represented by volumes.
Pool	Describe a group of volumes. Pools control which user has access to volumes in a group.
Volume	Describe an individual magnetic tape medium.

MDMS tries to reflect the true states of objects in the database. MDMS requests by users may cause a change in the state of objects. For some objects MDMS can only assume the state, for example: that a volume has been moved offsite. Wherever possible, MDMS tries to verify the state of the object. For example if MDMS finds a volume that should have been in a jukebox slot, in a drive, it updates the database with the current placement of the volume.

## 8.2 MDMS Interfaces

MDMS provides an internal callable interface to ABS and HSM software. This interfacing is transparent to the ABS or HSM user. However some MDMS objects can be selected from ABS and HSM.

MDMS communicates with the OpenVMS OPCOM facility when volumes need to be moved, loaded, unloaded, and for other situations where operator actions are required. Most MDMS commands allow control over whether or not an OPCOM message will be generated and whether or not an operator reply is necessary.

MDMS controls jukeboxes by calling specific callable interfaces. For SCSI controlled jukeboxes MDMS uses the MRD/MRU callable interface. For StorageTek jukeboxes MDMS uses DCSC. You still have access to these jukeboxes using the individual control software but doing so will make objects in the MDMS database out-of-date.

---

## Basic MDMS Operations

This chapter describes basic MDMS operations and functions that apply to many MDMS actions.

### 9.1 MDMS User Interfaces

MDMS includes two interfaces: a command line interface (CLI) and a graphic user interface (GUI). This section describes how these interfaces allow you to interact with MDMS.

### 9.2 DCL Interface

MDMS provides a DCL command line interface in addition to MDMSView. Some people prefer a command line interface, and it can also be used for automated command procedures. With this release, the entire command line interface is supported within MDMS, which maintains the database for media management.

#### 9.2.1 Syntax Overview

The MDMS DCL interface uses a consistent syntax for virtually all commands in the format:

```
$ MDMS VERB OBJECT_KEYWORD OBJECT_NAME /QUALIFIERS
```

The verb is a simple action word, and may be one of the following:

- ALLOCATE
- BIND
- CREATE
- DEALLOCATE
- DELETE
- INITIALIZE
- INVENTORY
- LOAD
- SET
- SHOW
- UNBIND
- UNLOAD

The object keyword is the object class name that the verb is to operate on. In MDMS, the object keyword cannot be omitted. MDMS supports the following object keywords:

- DOMAIN
- DRIVE

## Basic MDMS Operations

### 9.2 DCL Interface

- GROUP
- JUKEBOX
- LOCATION
- MAGAZINE
- MEDIA\_TYPE
- NODE
- POOL
- SERVER
- SCHEDULE
- VERSION
- VOLUME

Following the object keyword, you should enter an object name. This must be the name of an already-existing object unless the verb is “Create”, in which case the object must not already exist.

The qualifiers for all commands are non-positional and may appear anywhere in the command line.

There are two exceptions to the general command syntax, as follows:

- The Move verb takes two arguments. The first is the object name as normal, and the second is a destination object name. The destination object name is not preceded by an object keyword. An example of a Move command is:

```
MDMS MOVE VOLUME TLZ234 TLZ_JUKE/SLOT=4
```

- The Report verb, which takes a variable number of arguments. This verb uses the syntax of the old SLS Storage Report Volume command. Since the Report verb does not operate on any specific object, the first argument is always the keyword “Volume”, and the other argument is a comma-separated list of display and/or selection attributes. For example:

```
$ MDMS REPORT VOLUME VOLUME,STATE=ALLOCATED,SCRATCH_DATE,PLACEMENT,PLACNAME
```

#### 9.2.2 Object Lists

With this release of MDMS, all of the following commands accept a list of objects, so that you can operate on multiple objects in a single command:

- CREATE
- DELETE
- SET
- SHOW

If you specify an attribute in a CREATE or SET command and use an object list, then that attribute value is applied to all objects in the list.

### 9.2.3 Qualifier List

Certain qualifiers accept a list of attributes, and the list can be applied in one of three ways using an appropriate qualifier:

- /ADD - The specified value or list is added to any pre-existing list; this is the default option if you do not specify a qualifier
- /REMOVE - The specified value or list is removed from any pre-existing list
- /REPLACE - The specified value or list replaces any pre-existing list.

Consider the following examples:

```
MDMS CREATE GROUP COLORADO/NODES=(DENVER, SPRINGS, PUEBLO)
```

The group Colorado contains nodes Denver, Springs and Pueblo

```
MDMS SET GROUP COLORADO/NODE=ASPEN
```

The group Colorado now contains nodes Denver, Springs, Pueblo and Aspen. With no list qualifier specified, /ADD is applied by default.

```
MDMS SET GROUP COLORADO/NODE=ASPEN/REPLACE
```

The group Colorado now contains only node Aspen.

### 9.2.4 Inherit

All MDMS objects now accept the /INHERIT qualifier on Create. This allows you to create new objects and inherit most attributes of an existing object. This provides an easy way to “clone” objects, then apply the any differences in individual commands. It saves the effort of typing in all the attributes once a prototype has been established. In general, only non-protected fields of objects can be inherited.

In addition, the object list capability allows you to clone multiple objects in a single command. For example:

```
MDMS CREATE DRIVE DRIVE_2, DRIVE_3, DRIVE_4/INHERIT=DRIVE_1
```

This command creates three drives and applies all non-protected attributes of DRIVE\_1 to the three new drives.

### 9.2.5 Symbols

MDMS now supports symbols on all objects, which command procedures can read and process. To use symbols, enter a Show command for a single object (symbols are not supported for object lists). The symbols are generally in the format “MDMS\_INQ\_qualifier”, where “qualifier” is almost always the associated qualifier name for the attribute. The list of symbols for each show command is documented for that command, and is also available in DCL help.

When you issue a Show/Symbols, the show output is not displayed by default. If you wish to see the output as well, use Show/Symbols/Output.

### 9.2.6 Help and Reference

MDMS supports the normal DCL help mechanisms, as follows:

```
$ MDMS HELP [VERB] [KEYWORD] [/QUALIFIER]
```

```
$ HELP MDMS [VERB] [KEYWORD] [/QUALIFIER]
```

In addition, you can request help on any error message, for example:

## Basic MDMS Operations

### 9.3 User Interface Restrictions

```
MDMS HELP MESSAGE NOSUCHOBJECT
```

You can request help on any MDMS logical name, for example:

```
MDMS HELP LOGICAL MDMS%$LOGFILTER
```

Finally, you can locate the mapping of the old (pre-version 4.0A) ABS commands to the MDMS equivalent, for example:

```
MDMS HELP MAPPING CREATE ARCHIVE
```

The *MDMS Reference Guide* fully documents all DCL commands and qualifiers.

### 9.3 User Interface Restrictions

MDMSView and the MDMS DCL supports operations on Archive Backup System (ABS) objects only if an ABS or SLS license is loaded on the system. The ABS objects are:

- Archives
- Environments
- Restores
- Saves
- Selections

MDMS supports operations on the other media management objects if the system only has a Hierarchical Storage Management (HSM) license installed, or with an ABS or SLS license.

In addition, if the ABS license is the restricted OMT license, the following operations are not supported:

- Creation of archives or environments
- Support of the Remote Device Facility
- Support of DCSC-controlled jukeboxes
- Support of external scheduler products
- Save/restore frequencies other than Daily\_Full\_Weekly, On\_Demand and One\_Time\_Only

### 9.4 Graphical User Interface

MDMS provides a graphical user interface called *MDMSView*, which provides several views that you can use to manage your MDMS domain. MDMSview provides support for both media management and (if you have an ABS license) the Archive Backup System. MDMSView is designed to be the preferred interface to ABS and MDMS, with the goal of supporting most, if not all, of the regular management tasks. MDMSView supersedes all previous graphical interfaces for both ABS and MDMS.

MDMSview provides several views into the management of MDMS objects and requests, including ABS objects managed by MDMS. In V4.0A, a limited number of views have been implemented, but many more are planned for future releases. MDMSView currently supports the following views:

- *Domain View* - With this view, you can see the relationship between objects. For example, under a specific location, you can see the nodes, (child) locations and jukeboxes in that location. At the next level, you can, for example, see the drives in the jukebox. On selecting a specific object, you can then examine and optionally change its attributes.



- *Object View* - Similar to the domain view, but the navigation is by object class and is not hierarchical. For example, all 16 objects classes are listed, and all objects in those classes are displayed. You can then select an object to manipulate.
- *Report View* - This view allows you to generate reports on a class of object using selection criteria and attribute display options. Currently, the report view supports only volumes.
- *Request View* - This view allows you to examine current activities in the MDMS database server. A request summary and detailed request information is available, with a single click refresh.
- *Task View* - While both the domain and object view allow manipulation on a single object at a time, the task view allows you to perform operations on multiple objects at once, or use selection criteria to allocate objects. For example, you can create, show, delete and modify multiple objects (of the same type) in one operation.

Each view is provided in a tab from the main screen, and you can be working in several views at the same time, although only one is visible at a time. When switching from one view tab to another, the contents of the tab you are leaving are retained, and you can return to it at any time.

## 9.4.1 Starting MDMSView

### 9.4.1.1 OpenVMS Systems

MDMSView is installed at installation time on OpenVMS systems. Please refer to the Installation Guide for instructions on how to install MDMSView and Java on OpenVMS systems.

Once the installation is complete, the following commands are required to activate the GUI:

```
$ @SYS$STARTUP:JAVA$SETUP.COM  
$ SET DISPLAY/CREATE/NODE=nodename/TRANSPORT=TCPIP  
$ MDMS/INTERFACE=GUI
```

where *nodename* is the TCP/IP node name of the system on which the MDMSView display is to appear. Although the GUI itself must run on an Alpha System V7.2-1 and higher, using Java 1.2 or higher, the MDMSView display can be redirected to any OpenVMS system, including VAX systems and those running OpenVMS versions less than V7.2-1.

### 9.4.1.2 Windows Systems

A SETUP.EXE package is also installed on OpenVMS systems for use on Microsoft Windows (R) PCs. This file may then be transported to any Microsoft Windows PC and executed. The SETUP.EXE will install MDMSView at a default location of C:\MDMSView, although alternative locations are possible. Once the PC installation is complete, you can execute MDMSView by clicking on the mdmsview.bat file in that directory.

## 9.4.2 Look and Feel

Once MDMSView is started, it will come up with the default look and feel for the system. For OpenVMS systems, this is the Java/Metal look and feel. For Windows systems, this is the Windows look and feel. You can adjust the look and feel to your taste by using the View menu as follows:

- OpenVMS systems: View>Java Look and Feel or View>Motif Look and Feel
- Windows systems: View>Java Look and Feel, View>Motif Look and Feel or View>Windows look and feel

Changing the look and feel requires a new login, so it's a good idea to change this before logging in. The value is saved in the MDMSView initialization file, and is used on all subsequent invocations from this location.

## Basic MDMS Operations

### 9.4 Graphical User Interface

#### 9.4.3 Logging In

Once MDMSView is started and the look and feel is set, you need to log into an OpenVMS system, even if you are running on an OpenVMS system already. You can log into any OpenVMS node in the MDMS domain, as long as it supports TCP/IP communication. Logging in requires three fields, as follows:

- Node name: TCP/IP name, address or node name alias indicating the OpenVMS node that you wish to log into. This node must be running MDMS.
- User name: A valid OpenVMS user name on the selected node.
- Password: The password associated with the user account on the selected node.

If there is a login failure for any reason, the node name and user name are retained for subsequent retries, but the password must always be re-entered.

After a successful login, the login screen disappears and the MDMSView splash screen is displayed.

**Figure 9–1 MDMSView Main Screen**



#### 9.4.4 Selecting A View

The next step is to select a view depending on what you want to do. Here are some tasks that you might wish to perform, and the associated view(s) that support them:

- Configure the MDMS domain - Domain view, object view or task view
- Create new objects - Domain view, object view or task view
- Modify object attributes - Domain view, object view or task view
- See relationships between objects - Domain view
- Delete objects - Domain view or object view
- Observe current MDMS operations - Request view
- Generate volume reports - Report view
- Create multiple objects - Task view
- Allocate volumes based on selection criteria - Task view
- Initialize a set of volumes - Task view
- Run and save or restore request - Domain view or object view

The domain view and object view produce attribute and operation screens that work on one object at a time. The task view produces screens that can operate on multiple objects, but restrict the display of attributes to those that are common across the objects. The request view is a specialized view that allows you to show current requests (as a whole or in detail), and allows you to delete requests as needed. The report view is a specialized view that generates customized volume reports.

All view displays are divided into two parts:

- A left screen containing tree nodes for navigation purposes. The structure of the nodes are view-specific, but the general concept is that there is a level for object classes (for example, Jukebox or Drive), and under the class is a list of relevant objects (e.g. JUKE\_1, DRIVE\_1). You can expand or contract any node (except for leaf nodes) in a manner similar to Windows explorer. If you click on a class name, the associated list of objects are displayed on the right side of the screen. If you click on an object name, the object's attributes and operations screens are displayed on the right.
- A right screen which contains the object attributes, request information or report that you wish to view. When clicking a class name from the left side, the objects in that class are displayed as icons on the right side. You can double-click on any object icon to bring up the object's attributes and operations screens. In the request view, you can refresh the whole request display or an individual request display by clicking the refresh button.

While resizing the MDMSview screens is not supported, you can choose to view only the left or right screens by using the arrows at the top of the division between the left and right screens. Clicking on the left arrow eliminates the left screen, and clicking on the right arrow eliminates the right screen. To restore the dual screens, click on the opposite arrow.

## Basic MDMS Operations

### 9.4 Graphical User Interface

Figure 9–2 MDMS Object View Screen

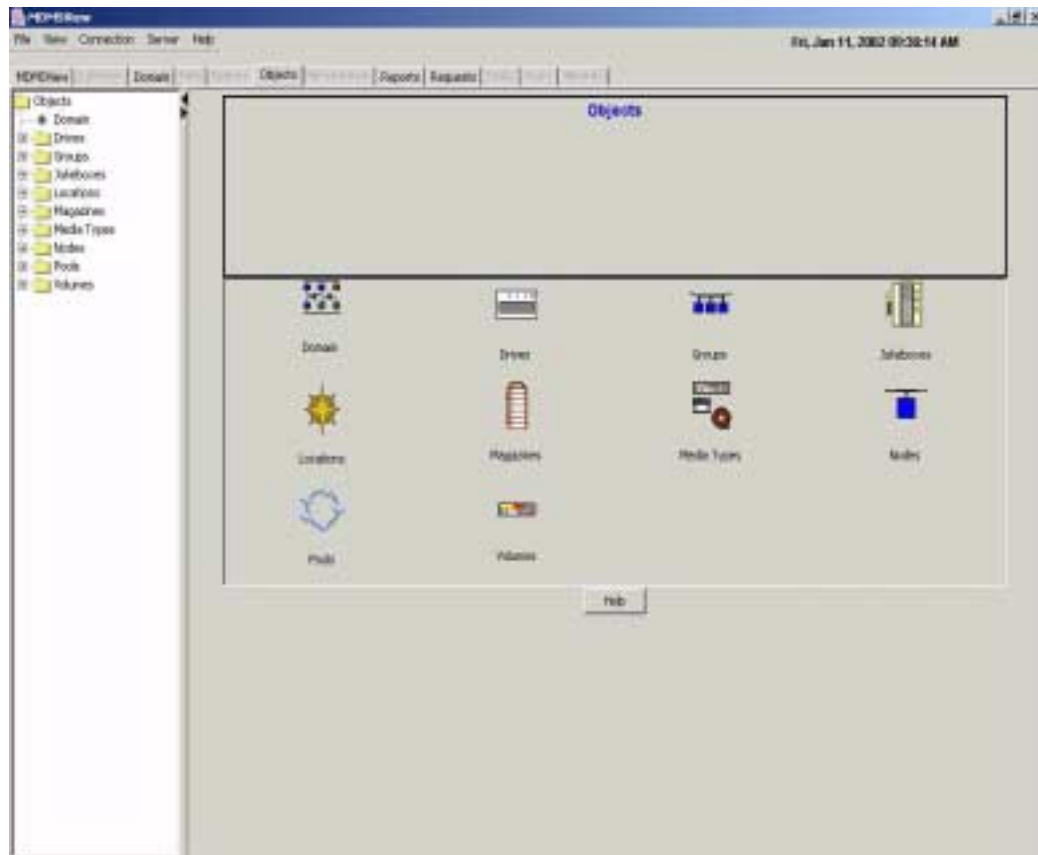

#### 9.4.5 Creating Objects

If you wish to create a new object, you can choose the Domain, Object or Task Views to accomplish this. The Domain and Object Views create objects one at a time, while the Task View can create multiple objects.

To create an object, use one of the following methods:

- Click on a class name (e.g. Jukebox) on the left screen, and the class object's icons are displayed on the right screen. On the right screen press the "Create" button to display a create screen.
- From the object view only, click on "Object", then double-click on one of the class icons that are displayed. On the right screen press the "Create" button to display a create screen.
- From the left screen, right-click on a class name, and a popup menu appears. Click on "Create" to display a create screen for that class.
- From the task view, expand the Create task and click on one of the class names that appear.
- From the task view, right click on the create task, and a popup menu appears. Click on the appropriate class name.

Once a create screen appears, (except for catalogs) you are prompted for two pieces of information:

- A name for the new object or objects
- An inherit object

## Basic MDMS Operations 9.4 Graphical User Interface

The domain and object views allow creation of only one object at a time, whereas the task view allows a comma-separated list of new objects (and also ranges in the case of volumes). Depending on the view, enter the name or names of the new objects you wish to create.

The inherit object allows you to copy most of the attributes from the inherit object to the object being created. If you wish to specify an inherit object, use the combo box to select the existing inherit object. This must be the same type of object, except in the case of restores, in which case you can inherit from either a restore or a save object.

After clicking create, the new object attribute and operations screens appear, which you can then modify to your liking. In the task view, this screen modifies all the newly created objects.

**Figure 9–3 Drive Create Screen**

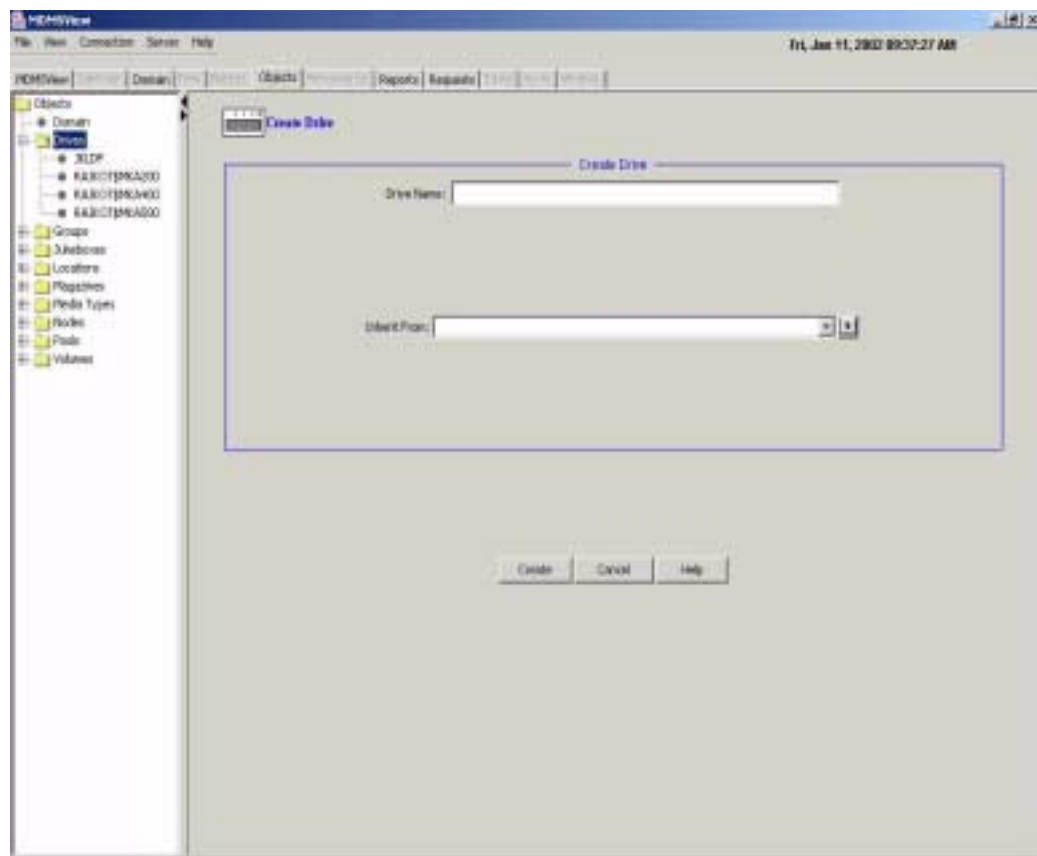

## Basic MDMS Operations

### 9.4 Graphical User Interface

#### 9.4.6 Showing and Modifying Objects

For objects that already exist, you can use the Domain View, Object View or Task View to show and optionally modify objects, or to perform operations on them.

To view an object, use one of the following methods:

- From the Domain or Object Views, from the left screen, expand a class name, and click on an object name.
- From the Domain or Object View, click on a class name from the left to bring up the class object icons on the right screen, then double click on an object icon.
- From the task View, expand the Show task, and click on one of the objects.
- From the Task View, right click on the Show task, and a popup menu appears, then click on an appropriate class and object.

When an object is selected, its attributes and operations are displayed in a two-dimensional tab screen as follows:

- Vertical tabs on the right side of the screen contain the Show and any operations associated with the object. Many objects just have a Show tab, but some (for example, volumes) have a whole list of operational tabs such as load, unload and so on. You can switch between the tabs by simply clicking on them.
- For the Show screen, there are also horizontal tabs that display related attributes about the object. Many simple objects have only a General tab that shows all attributes. Other attributes have General and Advanced tabs, if there is not enough room on one tab. Other tabs include:
  - A Show Access tab, which shows the access controls on the object. This is in a common format for all objects. If your site does not use access controls, you can disable these tabs using the view menu: View>No Access Control Tabs
  - The Show screen for Jukeboxes and Magazines also has a Contents tab that shows the current contents of the drives and slots in the jukebox, and the slots in a magazine.
  - Saves and Restores have a selections tab, that shows all selections for the save or restore, and a log tab that displays the latest version of the associated log file.

If you select the Show screen and wish to modify attributes, use the tool tip text for help on any field. Select appropriate values (from all the show tabs as needed), then click on Set. This sends the currently displayed values from all tabs to the MDMS server. If you just wish to view the object's attributes without modification, click on Cancel after viewing the attributes. This returns you to the object class screen.

MDMSView supports switching from one object to another during displaying of values. For objects that appear in combo boxes or lists, you can view related objects without losing the context of the current object. Each combo box or list attribute supports two methods of viewing, selecting and creating objects:

- Click on a small button to the right of the combo box or list to receive a popup menu for the field
- Right-click on the combo box or list and receive the same popup menu for the field

From the menu, there are the following options:

- Show - To show the selected object
- Create - To create a new object
- Reset - To go back to the previously selected objects

- Clear - To clear the selection
- Add and Remove (list only) - To add and remove an object by name
- List all (list only), lists all the objects

If you select Show or Create, you will go to an appropriate screen. When you then complete your operation on that object, you will come back to the original object.

### **9.4.7 Deleting Objects**

You can delete objects from the Domain, Object and Task Views. To delete an object, perform one of the following:

- Display the object as discussed in the previous section, then click the Delete button at the bottom of the screen.
- Right-click on the object name from the left screen, then select Delete from the pop-up menu.
- From the task view, select the Delete task, then select the object class, then select the object names from the list on the delete screen.

A request to delete an object will always bring up a Delete dialog box for confirmation of the delete. You can confirm “OK” or “Cancel” from here.

### **9.4.8 Viewing Relationships Between Objects**

The Domain view provides a way to view the hierarchical structure of the MDMS domain. The left side of the screen provides an object-class-object... hierarchy of objects belonging to other objects, or objects contained in other objects. The left side of the screen displays most of the object classes which contain other objects (the exceptions: selections, schedules and volumes, which have no sub-objects). You can begin the hierarchical navigation at any level, and all sub-levels can be displayed.

For example, starting at jukebox, you can view all objects that reside in a jukebox: Drives, Magazines and Volumes. If you then click on Drives, you will see all drives in this jukebox. If you then select a drive and click on it, you can see the volume in the drive.

If your domain is sufficiently complex, you might want to expand the left side of the screen by using the right arrow between the left and right screen. You can then view the entire hierarchy of the domain.

# Basic MDMS Operations

## 9.4 Graphical User Interface

Figure 9–4 Domain View Showing Expanded Relationships

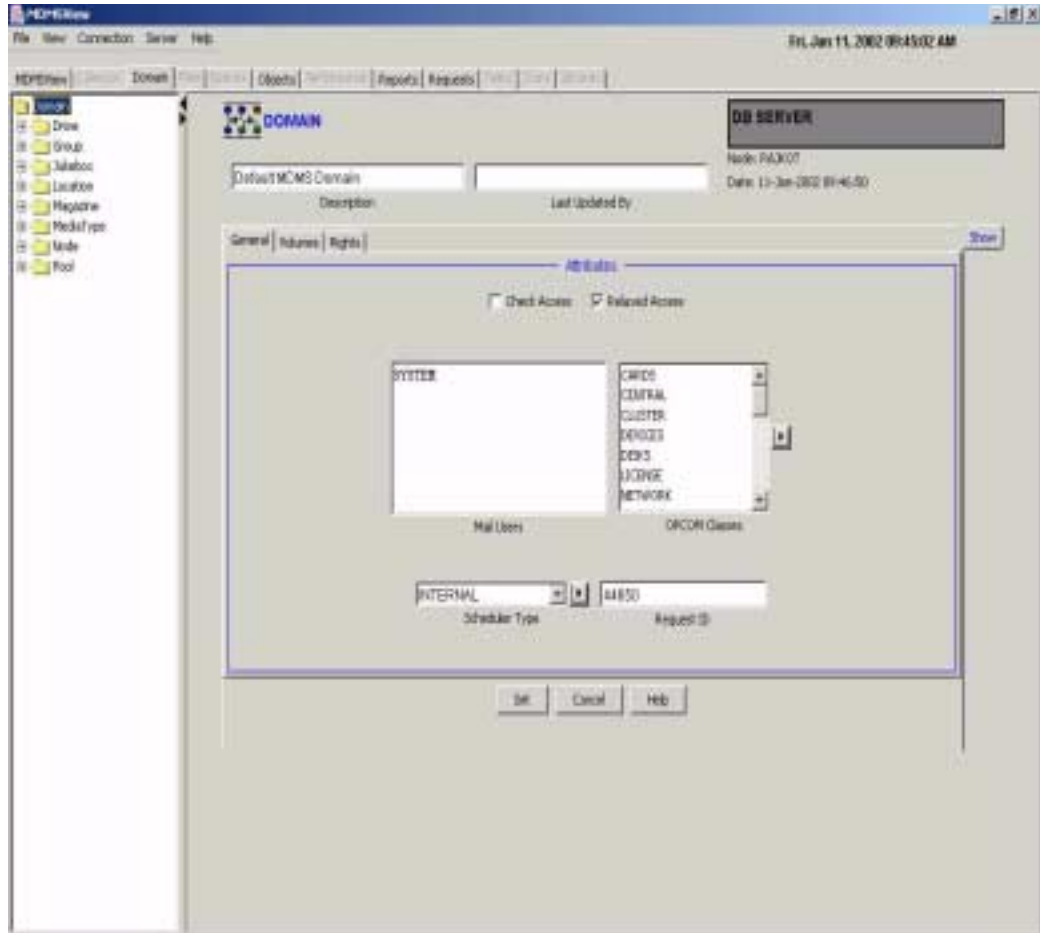



### 9.4.9 Performing Operations on Objects

If you wish to perform an operation on an object (for example, to load a volume into a drive), you should first display the object's attributes and operations screens. Then select the desired operation tab, on the right side of the screen. For example, to load a volume, show the volume then click on the Load tab.

The load tab is called an operations tab, and they all follows the same basic concepts. You enter options concerning the operation (for example, operator assistance), then press the appropriate operation button on the bottom left of the screen. This button is always labelled with the appropriate operation (for example, Load).

MDMS has the capability of performing long-running operations synchronously or asynchronously. However, in MDMSView, long-running operations are always submitted asynchronously and control is returned to the user. Asynchronous operations show a dialog box that states that the operation has been queued for processing, but has not yet completed. If you perform an operation that does not result in the dialog box, then you can safely assume it has been completed synchronously.

If you receive a "queued" dialog box, it does not necessarily mean that the operation was fully validated. If you want to check on the status of the operation, use the Request View to monitor the request's progress.

**Figure 9–5 Load Volume Screen with Queued Dialog Box**

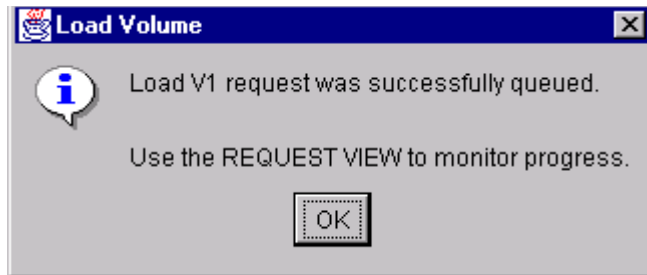

### 9.4.10 Showing Current Operations

The Request View provides a monitoring capability for all current MDMS operations. You can display all current requests by clicking on Show Requests - this results in a table of requests being displayed. This includes all current requests, and some recently-completed requests.

You can also expand the requests on the left side of the screen and click on a specific request for detailed information about the request. Or you can right-click on the request number on the left screen and select Show.

If you feel that a request is not working correctly, or for any reason you wish to delete the request, you can click on delete from the detailed request screen, or select a request number on the left screen, right-click and select delete from the popup menu.

As with other deletes, a dialog box will appear to confirm the delete of the request.

**Figure 9–6 Show Requests Screen**

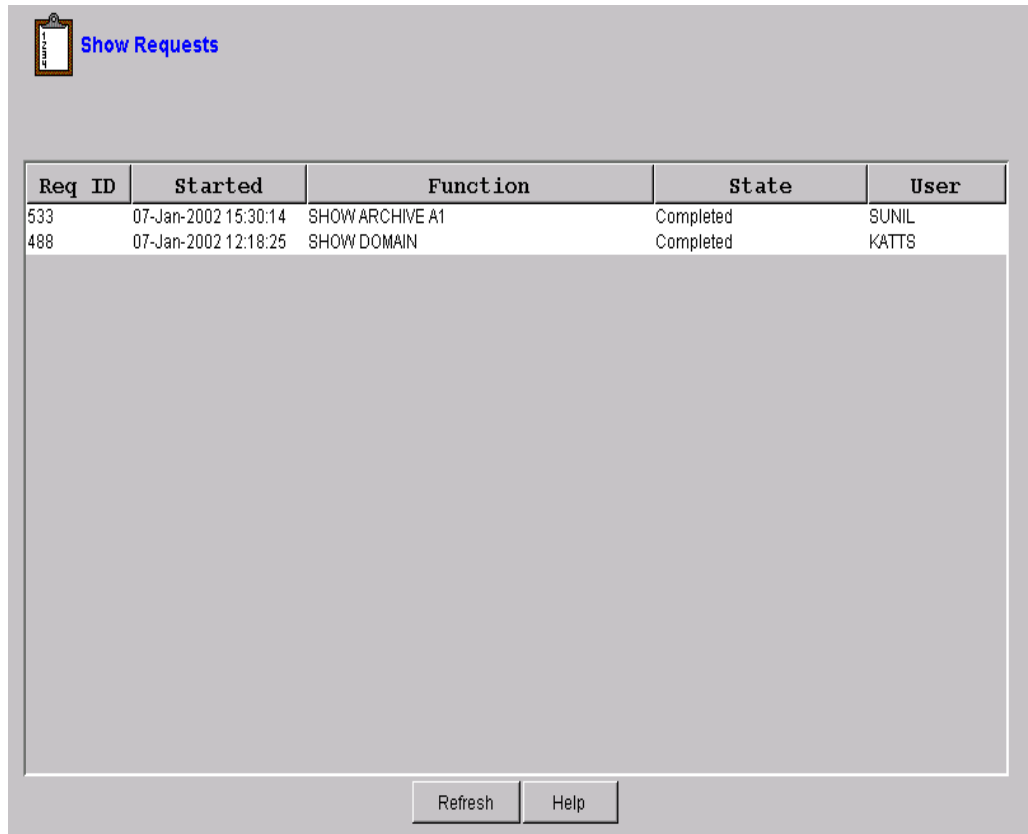

Req ID	Started	Function	State	User
533	07-Jan-2002 15:30:14	SHOWARCHIVE A1	Completed	SUNIL
488	07-Jan-2002 12:18:25	SHOW DOMAIN	Completed	KATTS

### 9.4.11 Reporting on Volumes

The Report View provides the capability of generating custom reports on volumes. With this view, you can choose attributes that can be displayed and/or used as selection criteria for volumes.

To select an attribute for display, simply click on the attribute and then press the right arrow button to move it to the display screen. The attributes are displayed in the report in the order selected. If you change your mind or wish to re-order the attributes, select an attribute on the display screen and press the left arrow button to deselect it.

If you wish to use an attribute as a selection criterion, click on the attribute, then click on “Use for Selection”. This will enable a field below (either a text field or combo box) to allow you to enter a selection.

You may display any number of fields and use any number of selection criteria to customize the report. When your selections are ready, you can generate the report by clicking on “Generate”. You can see the resultant report in the “Report Results” tab.

# Basic MDMS Operations

## 9.4 Graphical User Interface

If you wish to save this report, enter a report title in the text field at the bottom of the screen and click on save. The report is saved to the following locations:

- OpenVMS Systems:
  - sys\$common:[mdms.gui.vms]Report\_year\_month\_day\_hour\_minut\_second.txt
- Windows Systems:
  - C:\MDMSView\Report\_year\_month\_day\_hour\_minute\_second.txt

For example, a report file name is: Report\_2001\_12\_17\_8\_35\_17.txt

Once the results screen is displayed, you can sort the report using any field by clicking on the field's header. You can reverse-sort the same field by clicking on the field header again.

**Figure 9–7 Report View Selection Criteria Example**

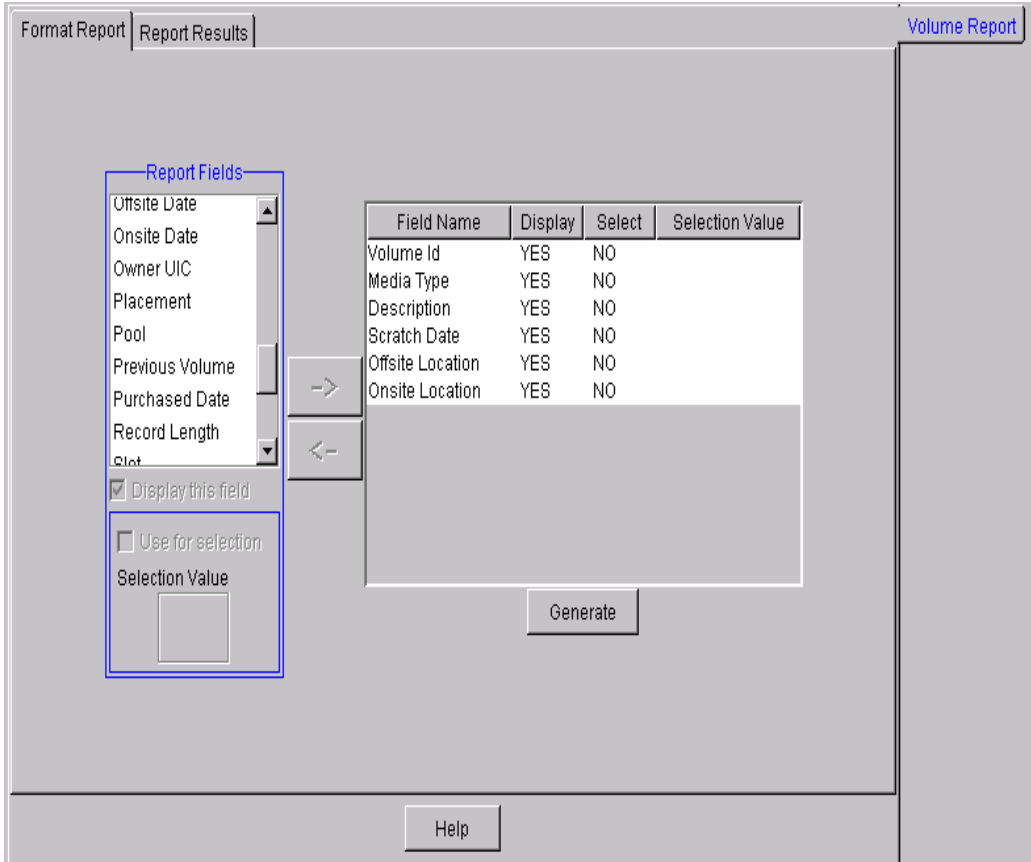

## Basic MDMS Operations

### 9.4 Graphical User Interface

Figure 9–8 Report View Results Screen

VolID	MediaType	Description	ScratchDate	OffsiteLoc	OnsiteLoc	PoolName	JukboxNa...	DriveName
V			07-Jan-200...					
V1	HSM							
V2						P		

#### 9.4.12 Viewing MDMS Audit and Event Logging

To examine past operations in MDMS, you can use the event view to view the MDMS audit and event logfile. There are five pre-configured options and a fully flexible custom option to allow you to select what you wish to see from the MDMS logfile. The five pre-configured options all apply to the MDMS Database Server logfile and show all operations (auditing and events) for the following amounts of time before the current time:

- The last minute
- The last 10 minutes
- The last hour
- The last 24 hours
- The last 72 hours

If you wish to see the logfile using other selection criteria, you can use the “Custom” setting. By clicking on “Custom”, a selection screen appears that allows you to select the entries to be displayed as follows:

- *Node selection:* You can choose the default of the DB server (which contains the most complete information), or select a specific client node. Note that request IDs are not supported on client nodes, and nor is selection by low and high request IDs.
- *Selection Options:* You can select a range of entries in the logfile to display by one of:
  - Elapsed time in minutes (default of 60 minutes) -OR-
  - Before and/or since dates (specified as an absolute time) -OR-

- Low and high request IDs (for DB server only)
- *Severity Options:* For audit completion entries, you can select that only entries of a certain combinations of completion status are displayed. You can select one or more of:
  - Success (S)
  - Informational (I)
  - Warning (W)
  - Error (E)
  - Fatal (F)

After entering the selection criteria, you click on the Show button to display. Depending on the size of the log file, this operation may take several seconds to complete. You may want to regularly reset your log files to avoid long response times. The code has been written to scan previous versions of log files if the date and or request selections are not in the latest log file.

The Refresh button at the bottom of the screen refreshes whatever selection is currently on the screen. The Cancel button allows you to enter a new selection.

### 9.4.13 Errors

MDMSView can report two types of errors:

- Those generated by MDMSView itself: these typically appear in a dialog box and in the status bar at the bottom of the screen. These errors normally explain an illegal user operation.
- Those generated by the MDMS server on the log-in node. These errors appear in a dialog box with the standard MDMS DCL syntax. These errors are documented in the *MDMS Reference Guide*.

### 9.4.14 Help

MDMSView provides three types of help:

- Tool-tip Help for every field on every screen. To obtain tool-tip help on a field, simply position the cursor on that field. The help appears near the field within one second and remains on the screen for 4 seconds.
- Screen-sensitive Help. For every screen in the Domain, Object or Task Views there is a “Help” button at the bottom right of each screen. If you press this “Help” button, a help screen pops-up with information about the screen you from which you pressed the button. The help information displayed is derived from this manual, the *ABS Guide to Operations*.
- Finally, there is a “Help” pull-down menu from the main screen. This provides the same type of Help as the “Help” button, but starts from the beginning of the manual. You can use the left-screen navigation or a search capability to find what you are interested in.

## Basic MDMS Operations

### 9.5 Access Rights for MDMS Operations

Figure 9–9 Context-Sensitive Help Screen from Show Volume Screen

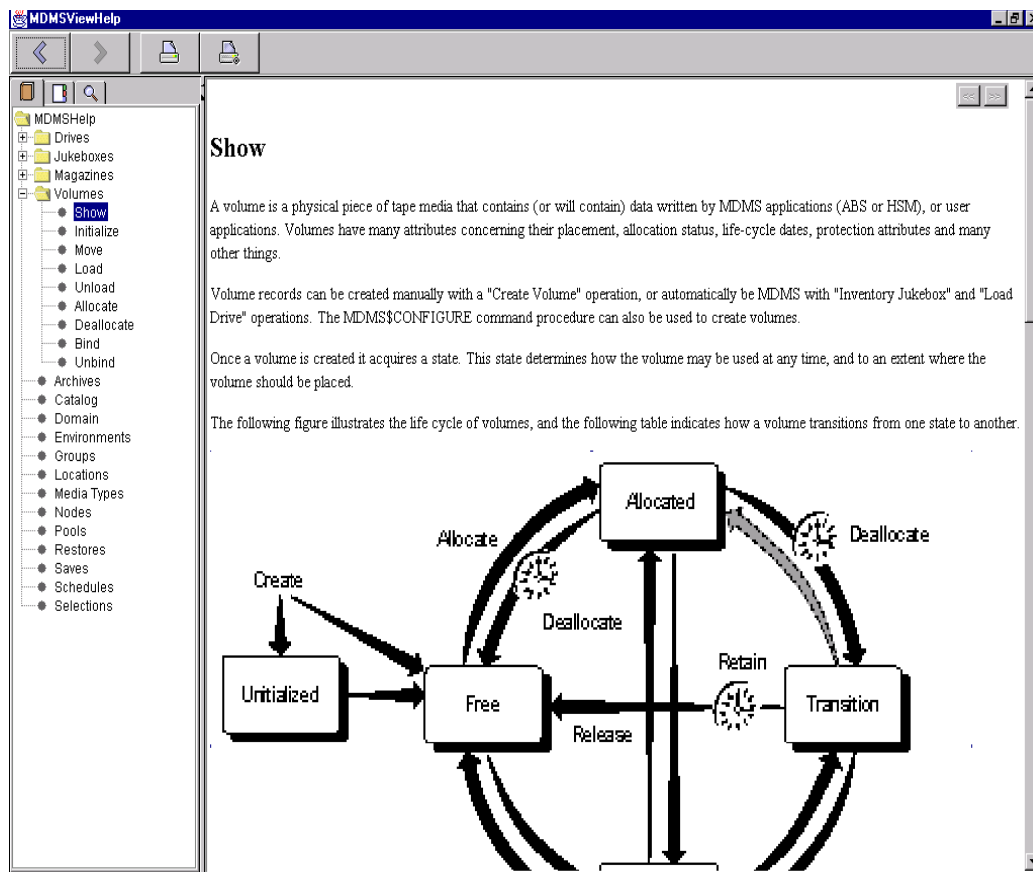

## 9.5 Access Rights for MDMS Operations

This section describes access rights for MDMS operations. MDMS works with the OpenVMS User Authorization File (UAF), so you need to understand the Authorize Utility and OpenVMS security before changing the default MDMS rights assignments.

MDMS rights control access to operations, not to object records in the database.

Knowing the security implementation will allow you to set up MDMS operation as openly or securely as required.

### 9.5.1 Description of MDMS Rights

MDMS controls user action with process rights granted to the user or application through low and high level rights.

#### 9.5.1.1 Low Level Rights

The low level rights are named to indicate an action and the object the action targets. For instance, the MDMS\_MOVE\_OWN right allows the user to conduct a move operation on a volume allocated to that user. The MDMS\_LOAD\_ALL right allows the user to load any managed volume.

For detailed descriptions of the MDMS low level rights, refer to the ABS or HSM Command Reference Guide.

### 9.5.1.2 High Level Rights

MDMS associates high level rights with the kind of user that would typically need them. Refer to the ABS or HSM Command Reference Guide for a detailed list of the low level rights associated with each high level right. The remainder of this section describes the high level rights.

#### **MDMS User**

The default MDMS\_USER right is for any user who wants to use MDMS to manage their own tape volumes. A user with the MDMS\_USER right can manage only their own volumes. The default MDMS\_USER right does not allow for creating or deleting MDMS object records, or changing the current MDMS configuration.

Use this right for users who perform non-system operations with ABS or HSM.

#### **MDMS Application**

The default MDMS\_APPLICATION right is for the ABS and HSM applications. As MDMS clients using managed volumes and drives, these applications require specific rights.

The ABS or HSM processes include the MDMS\_APPLICATION rights identifier which assumes the low level rights associated with it. Do not modify the low level rights values for the Domain application rights attribute. Changing the values to this attribute can cause your application to fail.

#### **MDMS Operator**

The default MDMS\_OPERATOR right supports data center operators. The associated low level rights allow operators to service MDMS requests for managing volumes, loading and unloading drives.

#### **The Default Right**

The low level rights associated with the MDMS\_DEFAULT right apply to any OpenVMS user who does not have any specific MDMS right granted in their user authorization (SYSUAF.DAT) file. Use the default right when all users can be trusted with an equivalent level of MDMS rights.

## 9.5.2 Granting MDMS Rights

The high level rights are defined by domain object record attributes with lists of low level rights. The high level rights are convenient names for sets of low level rights.

For MDMS users, grant high and/or low level rights as needed with the Authorize Utility. You can take either of these approaches to granting MDMS rights.

You can ensure that all appropriate low level rights necessary for a class of user are assigned to the corresponding high level right, then grant the high level rights to users.

You can grant any combination of high level and low level rights to any user.

## Basic MDMS Operations

### 9.5 Access Rights for MDMS Operations

Use the procedure outlined in Table 9–1 to review and set rights that enable or disable access to MDMS operations. CLI command examples appear in this process description but can use the GUI to accomplish this procedure as well.

**Table 9–1 Reviewing and Setting MDMS Rights**

Step...	Action...
1.	<p>Show the domain object record values for each high level right.</p> <ul style="list-style-type: none"><li>• For all system users, examine the default rights attribute.</li><li>• For MDMS operators, examine the operator rights attribute.</li><li>• For MDMS users, examine the user rights attribute.</li></ul> <p>Review the low level rights associated with each high level right. If you have questions about actions view the list of low level rights and the actions they enable.</p> <p>Example</p> <pre>\$MDMS SHOW DOMAIN /FULL</pre>
2.	<p>If the low level rights associated with the high level right are not adequate for a class of user, then add appropriate rights.</p> <p>If the low level rights associated with the high level right enable inappropriate options for a class of user, then remove the inappropriate rights.</p> <p>Example:</p> <pre>\$MDMS SET DOMAIN /OPERATOR_RIGHTS=MDMS_SET_PROTECTED/ADD</pre> <p>or</p> <pre>\$MDMS SET DOMAIN /USER_RIGHTS=MDMS_ASSIST/REMOVE</pre>
3.	<p>If you do not want all system users to have implicit access to MDMS operations, then negate the domain object record default rights attribute.</p> <pre>\$MDMS SET DOMAIN /NODEFAULT_RIGHTS</pre> <p>By default, a user with the OpenVMS SYSPRV privilege is granted all MDMS rights. If you wish to disable this feature, disable the SYSPRV privilege in the domain record:.</p> <pre>\$MDMS SET DOMAIN /NOSYSRV</pre>



**Table 9–1 Reviewing and Setting MDMS Rights**

Step...	Action...
4.	<p>If you want any user with ABS privileges to have access to appropriate MDMS rights to support just ABS operations, set the domain object record ABS rights attribute.</p> <pre>\$MDMS SET DOMAIN /ABS_RIGHTS</pre> <p>For all system user accounts that need access to MDMS, grant the appropriate rights.</p> <p>If a user needs only the rights associated with a class of user, grant that user the high level right associated with that class only.</p> <pre>UAF&gt; GRANT/IDENTIFIER MDMS_USER DEVUSER</pre>
5.	<p>If a user needs a combination of rights, then grant that user the high and/or low level rights needed to enable the user to do their job with MDMS. You must issue a separate command for each right granted.</p> <pre>UAF&gt; GRANT/IDENTIFIER MDMS_OPERATOR DCOPER</pre> <p>%UAF-I-GRANTMSG, identifier MDMS_OPERATOR granted to DCOPER</p> <pre>UAF&gt; GRANT/IDENTIFIER MDMS_LOAD_SCRATCH DCOPER</pre> <p>%UAF-I-GRANTMSG, identifier MDMS_LOAD_SCRATCH granted to DCOPER</p> <p>If you do not want a particular user to acquire the default rights, then disable the user’s ability to operate MDMS with the default rights.</p> <pre>UAF&gt; GRANT/IDENTIFIER MDMS_NO_DEFAULT APPUSER</pre>

## 9.6 Creating, Modifying, and Deleting Object Records

This section describes the basic concepts that relate to creating, modifying, and deleting object records.

### 9.6.1 Creating Object Records

Both the CLI and GUI provide the ability to create object records. MDMS imposes rules on the names you give object records. When creating object records, define as many attribute values as you can, or inherit attributes from object records that describe similar objects.

#### 9.6.1.1 Naming Objects

When you create an object record, you give it a name that will be used as long as it exists in the MDMS database. MDMS also accesses the object record when it is an attribute of another object record; for instance a media type object record named as a volume attribute.

MDMS object names may include any digit (0 through 9), any upper case letter (A through Z), and any lower case letter (a through z). Additionally, you can include \$ (dollar sign) and \_ (underscore).

## Basic MDMS Operations

### 9.6 Creating, Modifying, and Deleting Object Records

#### 9.6.1.2 Differences Between the CLI and GUI for Naming Object Records

The MDMS CLI accepts all these characters. However, lower case letters are automatically converted to upper case, unless the string containing them is surrounded by the “(double quote) characters. The CLI also allows you to embed spaces in object names if the object name is surrounded by the “ characters.

The MDMS GUI accepts all the allowable characters, but will not allow you to create objects that use lower case names, or embed spaces. The GUI will display names that include spaces and lower case characters if they were created with the CLI.

Compaq recommends that you create all object records with names that include no lower case letters or spaces. If you create an object name with lower case letters, and refer to it as an attribute value which includes upper case letters, MDMS may fail an operation.

#### Naming Examples

The following examples illustrate the concepts for creating object names with the CLI.

These commands show the default CLI behavior for naming objects:

```
$!Volume created with upper case locked
$MDMS CREATE VOLUME CPQ231 /INHERIT=CPQ000 !Standard upper case DCL
$MDMS SHOW VOLUME CPQ231
$!
$!Volume created with lower case letters
$MDMS CREATE VOLUME cpq232 /INHERIT=CPQ000 !Standard lower case DCL
$MDMS SHOW VOLUME CPQ232
$!
$!Volume created with quote-delimited lower case, forcing lower case naming
$MDMS CREATE VOLUME `icpq233i` /INHERIT=CPQ000 !Forced lower case DCL
$!
$!This command fails because the default behavior translates to upper case
$MDMS SHOW VOLUME CPQ233
$!
$!Use quote-delimited lower case to examine the object record
$MDMS SHOW VOLUME `icpq233i`
```

#### 9.6.2 Inheritance on Creation

This feature allows you to copy the attributes of any specified object record when creating or changing another object record. For instance, if you create drive object records for four drives in a new jukebox, you fill out all the attributes for the first drive object record. Then, use the inherit option to copy the attribute values from the first drive object record when creating the subsequent three drive object records.

If you use the inherit feature, you do not have to accept all the attribute values of the selected object record. You can override any particular attribute value by including the attribute assignment in the command or GUI operation. For CLI users, use the attribute's qualifier with the MDMS CREATE command. For GUI users, set the attribute values you want.

Not all attributes can be inherited. Some object record attributes are protected and contain values that apply only to the specific object the record represents. Check the command reference information to identify object record attributes that can be inherited.

#### 9.6.3 Referring to Non-Existent Objects

MDMS allows you to specify object record names as attribute values before you create the records. For example, the drive object record has a media types attribute. You can enter media type object record names into that attribute when you create the drive object before you create the media type object records.

### 9.6.4 Rights for Creating Objects

The low level rights that enable a user to create objects are MDMS\_CREATE\_ALL (create any MDMS object record) and MDMS\_CREATE\_POOL (create volumes in a pool authorized to the user).

### 9.6.5 Modifying Object Records

Whenever your configuration changes you will modify object records in the MDMS database. When you identify an object that needs to be changed you must specify the object record as it is named. If you know an object record exists, but it does not display in response to an operation to change it, you could be entering the name incorrectly. Section 9.6.1.1 describes the conventions for naming object records.

### 9.6.6 Protected Attributes

Do not change protected attributes if you do not understand the implications of making the particular changes. If you change a protected attribute, you could cause an operation to fail or prevent the recovery of data recorded on managed volumes.

MDMS uses some attributes to store information it needs to manage certain objects. The GUI default behavior prevents you from inadvertently changing these attributes. By pressing the Enable Protected button on the GUI, you can change these attributes. The CLI makes no distinction in how it presents protected attributes when you modify object records. Ultimately, the ability to change protected attributes is allowed by the MDMS\_SET\_PROTECTED right and implicitly through the MDMS\_SET\_RIGHTS right.

The command reference guide identifies protected attributes

### 9.6.7 Rights for Modifying Objects

The low level rights that allow you to modify an object by changing its attribute values are shown below:

**Table 9–2 Low Level Rights**

This right	Enables you to modify
MDMS_SET_ALL	Any MDMS database object record.
MDMS_SET_PROTECTED	Protected attributes used internally by MDMS.
MDMS_SET_OWN	Attributes of volumes allocated to the user.
MDMS_SET_POOL	Attributes of volumes in pools authorized to the user.
MDMS_SET_RIGHTS	The MDMS domain high level rights definition

### 9.6.8 Deleting Object Records

When managed objects, such as drives or volumes, become obsolete or fail, you may want to remove them from management. When you remove these objects, you must also delete the object records that describe them to MDMS.

When you remove object records, there are two reviews you must make to ensure the database accurately reflects the management domain: review the remaining object records and change any attributes that reference the deleted object records, review any DCL command procedures and change any command qualifiers that reference deleted object records.

## Basic MDMS Operations

### 9.6 Creating, Modifying, and Deleting Object Records

#### 9.6.9 Reviewing Managed Objects for References to Deleted Objects

When you delete an object record, review object records in the database for references to those objects. Table 9–3 shows which object records to check when you delete a given object record. Use this table also to check command procedures that include the MDMS SET command for the remaining objects.

Change references to deleted object records from the MDMS database. If you leave a reference to a deleted object record in the MDMS database, an operation with MDMS could fail.

**Table 9–3 Reviewing Managed Objects for References to Deleted Objects**

When you delete...	Review these object records...
Group	Drive Jukebox
Pool (Authorized, Default Users)	
Jukebox	Drive
Jukebox	
Magazine (MDMS sets the attribute)	
Volume (MDMS sets the attribute)	
Location	Domain (Offsite, Onsite Location)
Location	
Magazine (Offsite, Onsite Location)	
Node	
Volume (Offsite, Onsite Location)	
Media Type	Domain
Drive	
Volume	
Node	Drive
Group	
Jukebox	
Pool (Authorized, Default Users)	
Pool	Volume

#### 9.6.10 Reviewing DCL Command Procedures for References to Deleted Objects

When you delete an object record, review any DCL command procedures for commands that reference those objects. Other than the MDMS CREATE, SET, SHOW, and DELETE commands for a given object record, Table 9–4 shows which commands to check. These commands could have references to the deleted object record.

## Basic MDMS Operations

### 9.6 Creating, Modifying, and Deleting Object Records

Change references to deleted object records from DCL commands. If you leave a reference to a deleted object record in a DCL command, an operation with MDMS could fail.

**Table 9–4 Reviewing DCL Commands for References to Deleted Objects**

When you delete...	Review these DCL commands...
Drive	MDMS ALLOCATE DRIVE
	MDMS DEALLOCATE DRIVE
	MDMS LOAD DRIVE
	MDMS LOAD VOLUME
	MDMS UNLOAD DRIVE
Group	MDMS ALLOCATE DRIVE
	MDMS CREATE DRIVE
	MDMS CREATE JUKEBOX
	MDMS SET DRIVE
	MDMS SET JUKEBOX
Jukebox	MDMS ALLOCATE DRIVE
	MDMS ALLOCATE VOLUME
	MDMS CREATE MAGAZINE
	MDMS CREATE VOLUME
	MDMS INITIALIZE VOLUME
	MDMS INVENTORY JUKEBOX
	MDMS SET MAGAZINE
	MDMS SET VOLUME
	MDMS REPORT VOLUME
	MDMS SET JUKEBOX
Location	MDMS ALLOCATE DRIVE
	MDMS ALLOCATE VOLUME
	MDMS CREATE LOCATION (Location attribute)
	MDMS CREATE JUKEBOX
	MDMS CREATE MAGAZINE (Onsite, Offsite Location)
	MDMS CREATE NODE
	MDMS CREATE VOLUME (Onsite, Offsite Location)
	MDMS MOVE VOLUME
	MDMS REPORT VOLUME (Onsite, Offsite Location Fields)
	MDMS SET DOMAIN (Onsite, Offsite Location)
MDMS SET JUKEBOX	

## Basic MDMS Operations

### 9.6 Creating, Modifying, and Deleting Object Records

**Table 9–4 Reviewing DCL Commands for References to Deleted Objects**

When you delete...	Review these DCL commands...
Media Type	MDMS SET LOCATION (Location attribute)
	MDMS SET MAGAZINE (Onsite, Offsite Location)
	MDMS SET NODE
	MDMS SET VOLUME (Onsite, Offsite Location)
	MDMS ALLOCATE DRIVE
	MDMS ALLOCATE VOLUME
	MDMS CREATE DRIVE
	MDMS CREATE VOLUME
	MDMS INITITALIZE VOLUME
	MDMS INVENTORY JUKEBOX
	MDMS LOAD DRIVE
	MDMS REPORT VOLUME
	MDMS SET DOMAIN
	MDMS SET VOLUME
Node	MDMS ALLOCATE DRIVE
	MDMS CREATE DRIVE
	MDMS CREATE GROUP
	MDMS CREATE JUKEBOX
	MDMS CREATE POOL (Authorized, Default Users)
	MDMS SET DRIVE
	MDMS SET GROUP
	MDMS SET JUKEBOX
Pool	MDMS SET POOL (Authorized, Default Users)
	MDMS ALLOCATE VOLUME
	MDMS LOAD DRIVE
	MDMS REPORT VOLUME
Volume	MDMS SET VOLUME
	MDMS ALLOCATE DRIVE
Volume Set	MDMS ALLOCATE VOLUME/LIKE_VOLUME
	MDMS BIND VOLUME/TO_SET

### **9.6.11 Rights for Deleting Objects**

The low level rights that enable a user to delete objects are MDMS\_DELETE\_ALL (delete any MDMS object record) and MDMS\_DELETE\_POOL (delete volumes in a pool authorized to the user).





---

## Media Management

This chapter expands on the MDMS object summary given in Chapter 2, and describes all the MDMS objects in detail, including the object attributes and operations that can be performed on the objects.

Before going into details on each object, however, the use of the MDMS\$CONFIGURE.COM procedure is recommended to configure your MDMS domain and the objects in it. In many cases this should take care of your entire initial configuration.

### 10.1 MDMS Domain Configuration

If you are configuring your MDMS domain (including all objects in the domain) for the first time, Compaq recommends that you use the MDMS\$CONFIGURE.COM command procedure. This procedure prompts you for most MDMS objects, including domain, drives, jukeboxes, media types, locations and volumes, and establishes relationships between the objects. The goal is to allow complete configuration of simple to moderately complex sites without having to read the manual.

The configuration procedure offers extensive help, and contains much of the information contained in this chapter. Help is offered in a tutorial form if you answer “No” to “Have you used this procedure before”. In addition, for each question asked, you can enter “?” to have help on that question displayed. Furthermore, if you type “??” to a question, not only will the help be displayed, but in most cases a list of possible options is also displayed.

This procedure is also useful when adding additional resources to an existing MDMS configuration. To invoke this procedure, enter:

```
@MDMS$SYSTEM:MDMS$CONFIGURE.COM
```

and just follow the questions and help.

A complete example of running the procedure is shown in Appendix A.

### 10.2 Domain

The MDMS domain encompasses all objects that are served by a single MDMS database, and all users that utilize those objects. A domain can range from a single OpenVMS cluster and its backup requirements, to multi-site configurations that may share resources over a wide area network or through Fibre Channel connections. An OpenVMS system running MDMS is considered a node within the MDMS domain, and MDMS server processes within a domain can communicate with one another.

The MDMS domain object is created at initial installation, and cannot be deleted. Its main focus is to maintain domain-wide attributes and defaults, and these attributes are described in the following sections.

## Media Management

### 10.2 Domain

#### 10.2.1 ABS Rights

The domain attribute `ABS_RIGHTS` controls whether a user having certain pre-V4.0A ABS rights can map these to MDMS rights for security purposes (see Chapter 5, *Security*, for more information about rights). Setting the attribute allows the mapping, and setting the attribute to false disallows the mapping.

#### 10.2.2 Application Rights

The right `MDMS_APPLICATION_RIGHTS` is a high-level right that maps to a set of low level rights suitable for MDMS applications (for example, ABS and HSM). Normally these rights should not be changed, or at least not reduced from the default settings otherwise ABS and HSM may not function correctly. You may add rights to application rights if you have your own MDMS applications or command procedures. The ABS and `MDMS$SERVER` accounts should have `MDMS_APPLICATION_RIGHTS` granted in the User Authorization File.

#### 10.2.3 Check Access

The check access attribute determines if access controls are checked in the domain. MDMS uses two forms of security: Rights and Access Control. Rights checking is a task-oriented form of security and is always performed. However, access control is an object-oriented form of security and can be optionally enabled or disabled with this attribute. Setting Check Access enables access control checking. Clearing Check Access disables access control checking even if there are objects with access control entries.

#### 10.2.4 Deallocate State

When a volume is deallocated after its data has expired, it may go into one of two states. The transition state is an interim state that the volume goes into after deallocation, but it is not eligible to be used again until a period of time called the transition time expires. This is a safety feature that allows you to examine whether the data has legitimately expired, and if not to retain the volume (put back to the allocated state). If you do not wish this feature, you can disable the transition state and allow volume to return directly to the free state, where it is eligible for immediate allocation and initialization for new data. The domain deallocate state is applied to all volumes that are automatically deallocated by MDMS. When manually deallocating volumes, you can override the domain deallocate state with a state on the deallocate operation itself.

#### 10.2.5 Default Rights

The MDMS default rights attribute maps a set of MDMS low-level rights to all users in the domain. This allows you to give all users a limited set of rights to access MDMS objects and perform operations, without having to expressly modify their accounts. Be aware that default rights are applied to all users on all nodes in the domain, so granting such rights should be carefully reviewed. By default, MDMS maps no rights to the default rights.

#### 10.2.6 Mail Users

When MDMS deallocates volumes based on their scratch date (an operation that is performed once per day), it sends a mail message indicating which volumes were deallocated to the set of users defined in the mail users attributes. You should enter a list of users in the format `node::username`. Every user in the list will receive the deallocate volume mail messages.

### 10.2.7 Maximum Scratch Time

The maximum scratch time is the maximum scratch time that can be applied to any volume when it is allocated. The scratch time is the period of time that you wish the volume to stay allocated because its data is still valid. The maximum scratch time imposes a maximum limit and overrides the volume's scratch time if it exceeds the maximum. For HSM, the maximum scratch time should be set to zero (unlimited), as HSM volumes' data remains valid until it is repacked. For ABS uses, this value should be set to the longest period of time you wish to retain any volume.

### 10.2.8 Media Type

The domain media type attribute is the media type that is applied to new volumes and drives by default when they are created. In a simple configuration, you may only have a single media type, so specifying it in the domain allows you to not have to specify it when creating individual drives and volumes. It may also be applied as a default to ABS archives. You may always override the domain default media type with a specific media type when you create or modify drives and volumes.

### 10.2.9 Offsite Location

The domain offsite location attribute is applied by default to the offsite location field of new volumes when they are created. The offsite location is an MDMS location that is used for secure storage of the volumes in case of a disaster. You can always override the domain default offsite location when you create or modify volumes.

### 10.2.10 Onsite Location

The domain onsite location attribute is applied by default to the onsite location field of new volumes when they are created. The onsite location is an MDMS location that is used for storage of the volumes when they are onsite, or quickly accessible to jukeboxes and drives. You can always override the domain default onsite location when you create or modify volumes.

### 10.2.11 OPCOM Classes

The domain OPCOM classes attribute contains the default OPCOM classes that are applied to new node objects by default when they are created. OPCOM classes are classes of users whose terminals are enabled to receive certain OPCOM classes. You can override the domain default OPCOM classes with specific classes on a per-node basis when you create or modify a node.

### 10.2.12 Operator Rights

The right MDMS\_OPERATOR\_RIGHTS is a high-level right that maps to a set of low level rights suitable for operators managing the domain. The default set of operator rights allow for normal operator activities such as loading and unloading volumes into drives, showing any object or operations, and moving volumes offsite and onsite. However, you can add or remove low level rights to/from the operator rights as you wish.

### 10.2.13 Protection

The domain protection attributes defines the default protection applied to new volumes when they are created. This protection is used by MDMS when it initializes volumes, and writes the protection on the magnetic tape volume itself. You can always override the domain default protection by specifying the protection specifically when creating or modifying a volume.

## Media Management

### 10.2 Domain

#### 10.2.14 Relaxed Access

The relaxed access attribute controls the security when a user or application tries to access an object without any access control entries, and access control checking is enabled. If relaxed access is set, such access is granted. If relaxed access is clear, such access is denied. The relaxed access attribute is ignored if the check access attribute is clear.

#### 10.2.15 Request ID

MDMS uses sequentially increasing request identifiers for each request received by the MDMS database server, and this attribute displays the ID of the next request. If this ID is becoming very large, you can reset it to zero or one (or indeed any value) if you wish. The request ID automatically resets to one when it reaches one million.

#### 10.2.16 Scheduler Type

MDMS performs scheduling operations on behalf of itself and ABS. For ABS scheduling, you can choose a scheduler type that best meets your needs, as follows:

- *Internal* - The default internal scheduler type uses MDMS schedule objects and OpenVMS batch queues. This option should be sufficient for most sites as the schedule object supports many custom scheduling options.
- *External* - This option uses MDMS schedule objects and OpenVMS batch queue, but the scheduling is submitted through a command procedure. You can use this option if you have a need to modify the command procedure to perform site-specific operations.
- *Scheduler* - This option uses an external scheduler product via command procedures. ABS supplies a template scheduler command procedure that you can modify to access your own scheduler product. You can also use this option to invoke the pre-V3.0 ABS DEC Scheduler V2.1B, as long as you have a license for that product.

MDMS-initiated scheduled operations such as MDMS\$MOVE\_VOLUMES always use the internal MDMS scheduler.

#### 10.2.17 Scratch Time

The domain default scratch time is the default scratch time applied to new volumes when they are created. Scratch time indicates how long a volume is to remain allocated (that is, how long its data is valid and needs to be kept). You can override the domain volume scratch time when you create, modify or allocate individual volumes. For HSM volumes, the scratch time should be set to zero (unlimited), since HSM data remains valid until a volume is repacked.

#### 10.2.18 SYSPRV

MDMS uses user account rights as one mechanism for security within the domain. MDMS allows you to control whether the OpenVMS privilege SYSPRV can map to the ultimate MDMS right MDMS\_ALL\_RIGHTS. If you set the SYSPRV attribute, users with SYSPRV are assigned MDMS\_ALL\_RIGHTS, which means they can perform any operation subject to access control checks. Clearing SYSPRV gives users with SYSPRV no special rights.

---

#### Note

**If you wish to use the SYSPRV attribute from the MDMSView GUI, the user's authorization file must have SYSPRV defined as a privilege and a default privilege. Having SETPRV is not sufficient as there is no way to set the SYSPRV privilege from the GUI.**

---

### 10.2.19 Transition Time

The domain default transition time is applied to volumes by default when they are deallocated into the transition state. The transition time determines how long the volumes remain in the transition state before moving to the free state. This attribute is used alongside the deallocation state attribute, which determines the default state that volumes are deallocated into. You can override the domain default transition time when you create, modify, or deallocate a volume.

### 10.2.20 User Rights

The right MDMS\_USER\_RIGHTS is a high-level right that maps to a set of low level rights suitable for non-privileged users that perform ABS or HSM operations. The default set of user rights allow for user activities such as creating and manipulating their own volumes and loading and unloading those volumes into drives, showing their volumes. However, you can add or remove low level rights to/from the user rights as you wish.

## 10.3 Drives

A drive is a physical resource that can read and write data to tape volumes. Drives can be standalone requiring operator intervention for loading and unloading, in a stacker configuration that allows limited automatic sequential loading of volumes, or in a jukebox which provides full random-access automatic loading. Drives are named in MDMS using a unique name across the domain; it may or may not be the same as the OpenVMS device name, as these may not be unique across the domain.

The following sections describe the attributes of a drive.

### 10.3.1 Access

The access attribute controls whether the drive may be used from local access, remote access or both. Local access includes direct SCSI access, access via a controller such as the HSJ70, access via TMSCP, or access via Fibre Channel, and does not require use of the Remote Device Facility (RDF). Remote access is via a DECnet network requiring RDF. You can set the access to one of the following:

- All - Allows both local and remote access (default)
- Local - Allows only local access (as defined above)
- Remote - Allows only remote access using RDF

### 10.3.2 Automatic Reply

Automatic reply is the capability of polling hardware to determine if an operator-assist action has completed. For example, if MDMS requests that an operator load a volume into a drive, MDMS can poll the drive to see if the volume was loaded, and if so complete the OPCOM request without an operator reply. Set automatic reply to enable this feature, and clear to require an operator response. Please note that some operations cannot be polled and always require an operator reply. The OPCOM message itself clearly indicates if a reply is needed or automatic replies are enabled.

### 10.3.3 Device

The device attribute is the OpenVMS device name for the drive. In many cases you can set up the drive name to be the OpenVMS device name, and this is the default when you create a drive. However, the drive name must be unique within the domain, and since the domain can consist of multiple clusters there may be duplicate device names across the domain. In this case you must use different drive names from the OpenVMS device names. Also, you can specify simple or descriptive drive names which are used for most commands, and hide the OpenVMS device in the device name attribute.

## Media Management

### 10.3 Drives

#### 10.3.4 Disabled

By default, drives are enabled, meaning that they can be used by MDMS and its applications. However, you may wish to disable a drive from use because it may need repair or be used for some other application. Set the disabled flag to disabled the drive, and clear the flag to enable the drive.

#### 10.3.5 Drive Number

If the drive is in a robotically-controlled jukebox, and the jukebox is controlled by MRD, you must set the drive number to the relative drive number in the jukebox used by MRD. Drives in jukeboxes are numbered from 0 to n, according to the SCSI addresses of the drives. Refer to the jukebox documentation on how to specify the relative drive number.

#### 10.3.6 Groups

The groups attribute contains a list of groups containing nodes that have direct access to the drive. Direct access includes direct-SCSI access, access via a controller such as an HSJ70, access via TMSCP, and access via Fibre Channel. You can specify as many groups as you wish, in addition to nodes that may not be in a group.

#### 10.3.7 Jukebox

If the drive is in a jukebox, you must specify which jukebox using the jukebox attribute. Enter a valid jukebox name from an MDMS-defined jukebox. If there is no jukebox, MDMS treats the drive as a standalone drive or as a stacker.

#### 10.3.8 Media Types

A drive must support one or more media types in order for volumes to be used on the drive. In the media type attribute, specify one or more MDMS-defined media types that this drive can both read and write. If you wish, you can restrict the media types to a subset that you wish this drive to handle, and not all the media types it could physically handle. In this way, you can restrict the drive's usage somewhat.

#### 10.3.9 Nodes

The nodes attribute contains a list of nodes that have direct access to the drive. Direct access includes direct-SCSI access, access via a controller such as an HSJ70, access via TMSCP, and access via Fibre Channel. You can specify as many nodes as you wish, in addition to groups of nodes in the groups attribute.

#### 10.3.10 Read-Only Media Types

In addition to media types that a drive can read and write, a drive may support one or more additional media types that it can only read. In the read-only media type attribute, specify one or more MDMS-defined media types that this drive can only read. This allows this drive to be used when the application operation is read-only (for example, HSM unshelves or ABS restores). Do not duplicate a media type in both the media type list and read-only media type list.

#### 10.3.11 Shared

You can designate whether a drive is to be used by MDMS applications and users only, or by non-MDMS users. If the drive is not shared, the MDMS server process allocates the drive on all clusters to prevent non-MDMS users and applications from allocating it. However, when an MDMS user attempts to allocate the drive, MDMS will deallocate it and allow the allocation. Set the shared attribute if you wish to share the drive with non-MDMS users, and clear if you wish to restrict usage to MDMS users. ABS users who do their own user backups are considered MDMS users, as are all system backups and HSM shelving/unshelving users.

### 10.3.12Stacker

Certain types of drive can be configured as a stacker, which allows a limited automatic sequential loading capability of a set of volumes. Such drives may physically reside in a loader or have specialized hardware that allows stacker capabilities. If you wish the drive to support the stacker loading capability, set this attribute and make sure the jukebox attribute does not contain a jukebox name. If you wish the drive to operate as a jukebox or standalone drive, clear this attribute.

### 10.3.13State

The drive state field determines the load state of the drive. The drive can be in one of four states:

- *Empty* - There is no volume in the drive
- *Full* - There is a volume in the drive
- *Loading* - A volume is being loaded into the drive
- *Unloading* - A volume is being unloaded from the drive

This is a protected field that is normally handled by MDMS. Only modify this field if you know that there are no outstanding requests and the new state reflects the actual state of the drive.

### 10.3.14Allocate Drive (DCL Only)

You allocate a drive so that you can use it for reading and writing data to a volume. If you allocate a drive, your process ID and node is stored in the MDMS database, and the drive is allocated in OpenVMS for your process. Because the MDMSView GUI does not operate in a process context, it is not possible to allocate drives from the GUI.

You can either allocate a drive by name, or you can specify selection criteria to be used for MDMS to select an available drive for you and allocate it. The allocation selection criteria include:

- *Media Type* - Select a drive with the specified media type
- *Location* - Used with media type, select a drive in the specified location
- *Jukebox* - Used with media type, select a drive in the specified jukebox
- *Group* - Used with media type, select a drive that is supported by a node in the group
- *Node* - Used with media type, select a drive that is supported by the node
- *Volume* - Select a drive that is compatible with the specified volume (media type and placement)

You can also specify the following options when allocating a drive:

- *Assist* - A flag indicating whether you wish operator assistance if a drive cannot be allocated. Set if you wish assistance, and clear if you wish to use the retry limit and intervals to automatically retry (that is, wait for drives to become available).
- *Define* - Use define to set a logical name for the drive. The logical name evaluates to both the MDMS Drive Name and the OpenVMS device name, and can be used in either MDMS or other DCL commands.
- *Retry Limit and Interval* - If you wish the allocate to retry if there are no available drives, set the retry limit and interval, and specify noassist.
- *Preferred* - If you allocated a drive for a specific volume, you can set preferred to request that the same drive that the volume was last loaded is the preferred drive. If you clear preferred, this forces MDMS to perform a round-robin allocation of the drives.
- *Reply* - You can specify a symbol to receive an operator's reply message.

## Media Management

### 10.3 Drives

- *Nowrite* - You can specify that the drive only has to be compatible for read-only media types, as the desired operation will only read from the drive.

#### 10.3.15 Deallocate Drive (DCL Only)

If you allocated a drive using the DCL “Allocate Drive” command, you should deallocate the drive when you are finished using it, otherwise the drive will remain allocated until your process exits.

Simply issue a deallocate drive and specify the drive name or the logical name obtained from the define option in “Allocate Drive”.

#### 10.3.16 Load Drive

MDMS supports two ways to load volumes into drives:

- *Load Drive* - This loads a scratch volume into a drive via operator intervention or by stacker operation. As such, this option is only for standalone and stacker controlled drives.
- *Load Volume* - This loads a specific volume into a drive, and can apply to all types of drive.

This section discusses the load drive option. The load volume option is discussed under volumes.

The “Load Drive” operation requests either that a scratch volume (in the free state) be loaded into the drive, or the next volume in the stacker is loaded into the drive. In either case, the volume ID of the volume is not known until the load completes, and MDMS reads the magnetic tape label to determine the volume.

The loaded volumes may or may not already be defined in the MDMS database. You can choose to create volume records by setting the “Create” flag, and optionally providing attributes to apply to the volume as follows:

- *Inherit volume ID* - This is the most comprehensive option as it allows the new volume to inherit all non-protected fields from the specified volume.
- *Media type* - Assign this media type to the volume. If you use inherit and media type, the specified media type overrides the inherit media type
- *Pool* - Assign this volume to the specified pool. If you use inherit and pool, the specified pool overrides the inherit pool.

When issuing the load drive request, you can specify whether the load is for read/write (almost always the case) or read-only, and whether operator assistance is required.

You can also specify an alternative message for the operator. This is included in the OPCOM message instead of the normal MDMS operator message. Use of an alternative message is not recommended.

When initiating a load from the DCL, you can choose a synchronous operation (default) or an asynchronous operation using the /NOWAIT qualifier. From MDMSView, a load is always asynchronous, so that you can continue performing other tasks.

#### 10.3.17 Unload Drive

Unlike the load drive operation, the unload drive can be applied to any type of drive at any time. What it does is simply unload the current volume in the drive, and so you can use this when you don't know which volume is in the drive. Alternatively, you can use the unload volume operation if you know the volume ID in the drive.

The only option for unload drive is to request operator assistance if needed.



When initiating an unload from the DCL, you can choose a synchronous operation (default) or an asynchronous operation using the /NOWAIT qualifier. From MDMSView, an unload is always asynchronous, so that you can continue performing other tasks.

## 10.4 Groups

The group object is a logical object that is simply a list of nodes that have something in common. Groups can be used to represent an OpenVMS cluster, a collection of nodes that have access to a device, or for any other purpose. A node may appear in any number of groups. Groups can be specified instead of, or in addition to nodes in drive, jukebox, save and restore objects, and can be used interchangeably with nodes in pool authorization and access control definitions.

Groups contain only one attribute.

### 10.4.1 Nodes

The list of nodes that comprise the group. Nodes must be OpenVMS nodes that are defined in the MDMS database. You should not use groups for non-OpenVMS nodes (for example, ABS UNIX or Windows clients).

## 10.5 Jukeboxes

In MDMS, a jukebox is a generic term applied to any robot-controlled device that supports automatic loading of volumes into drives. Jukeboxes include small, single-drive loaders, large multi-drive libraries and very large silos containing thousand of volumes. In general MDMS does not make distinctions among the types of jukeboxes, except for the software subsystem used to control them. MDMS supports both the Media Robot Device (MRD) subsystem for SCSI-controlled robots, and the Digital Cartridge Server Component (DCSC) subsystem for certain silos.

The next sections describe the jukebox attributes.

### 10.5.1 Access

The access attribute controls whether the jukebox may be used from local access, remote access or both. Local access includes direct SCSI access, access via a controller such as the HSJ70, or access via Fibre Channel, and does not require use of the Remote Device Facility (RDF).

Remote access is via a DECnet network requiring RDF. You can set the access to one of the following:

- All - Allows both local and remote access (default)
- Local - Allows only local access (as defined above)
- Remote - Allows only remote access using RDF

### 10.5.2 ACS ID

For DCSC-controlled jukeboxes, the ACS identifier specifies the Automated Cartridge System Identifier. Each MDMS jukebox maps to one Library Storage Module (LSM), and requires the specification of the Library, ACS and LSM identifiers.

### 10.5.3 Automatic Reply

Automatic reply is a capability of polling hardware to determine if an operator-assist action has completed. For example, if MDMS requests that an operator move a volume into a port, MDMS can poll the port to see if the volume is there, and if so complete the OPCOM request without an operator reply. Set automatic reply to enable this feature, and clear to require an operator response. Please note that some operations cannot be polled and always require an operator reply. The OPCOM message itself clearly indicates if a reply is needed or automatic replies are enabled.

## Media Management

### 10.5 Jukeboxes

#### 10.5.4 Cap Size

For DCSC-controlled jukeboxes equipped with Cartridge Access Points (CAPs), this attribute specifies the number of cells for each CAP. The first number is the size for CAP 0, the second for CAP 1, and so on. If a size is not specified, a default value of 40 is used. Specifying a cap size optimizes the movement of volumes to and from the jukebox by filling the CAP to capacity for each move operation.

#### 10.5.5 Control

The control attribute determines the software subsystem that performs robotic actions in the jukebox. The control may be one of the following:

- *MRD* (Media Robot Device) - The default control uses SCSI commands to control the robot in the jukebox. When you specify MRD, you should also specify slot count, robot device name and a flag as to whether the jukebox supports magazines.
- *DCSC* (Digital Cartridge Server Component) - MDMS uses the DCSC subsystem to control the device. When you specify DCSC, you should also specify library ID, ACS ID, LSM ID and CAP sizes. DCSC is used for certain large silo devices only.

#### 10.5.6 Disabled

By default, jukeboxes are enabled, meaning that they can be used by MDMS and its applications. However, you may wish to disable a jukebox from use because it may need repair or be used for some other application. Set the disabled flag to disabled the jukebox, and clear the flag to enable the jukebox.

#### 10.5.7 Groups

The groups attribute contains a list of groups containing nodes that have direct access to the jukebox. Direct access includes direct-SCSI access, access via a controller such as an HSJ70, and access via Fibre Channel. TMSCP access is not supported for jukeboxes. You can specify as many groups as you wish, in addition to nodes that may not be in a group.

#### 10.5.8 Library ID

For DCSC-controlled jukeboxes, the Library identifier specifies the library that this jukebox is in. Each MDMS jukebox maps to one Library Storage Module (LSM), and requires the specification of the Library, ACS and LSM identifiers.

#### 10.5.9 Location

The location attribute specifies the physical location of the jukebox. Location can be used as a selection criterion for selecting volumes and drives. Specify an MDMS-defined location for the jukebox. This location may be the same as, or different from, the onsite location that volumes are stored in when not in a jukebox. If different, moves from the jukebox to the onsite location and vice versa will be done in two phases: jukebox to jukebox location, then jukebox location to onsite location, and vice versa.

#### 10.5.10 LSM ID

For DCSC-controlled jukeboxes, the Library Storage Module (LSM) identifier specifies the LSM that comprises this jukebox. Each MDMS jukebox maps to one Library Storage Module (LSM), and requires the specification of the Library, ACS and LSM identifiers.

### 10.5.11 Nodes

The nodes attribute contains a list of nodes that have direct access to the jukebox. Direct access includes direct-SCSI access, access via a controller such as an HSJ70, and access via Fibre Channel. TMSCP access to jukeboxes is not supported. You can specify as many nodes as you wish, in addition to groups of nodes in the groups attribute.

### 10.5.12 Robot

For MRD-controlled jukeboxes, the robot name is the OpenVMS device name of the robot device. Robot names normally fall into one of several formats:

- GKx0 or GKxn01 for direct-connect SCSI
- \$n\$DUAnnn for access via an HSJ-type controller
- \$2\$GGnx for Fibre Channel access

If the jukebox is controlled by direct connect SCSI (first option), the device must be first loaded on the system with one of the following DCL commands:

```
Alpha - $ MCR SYSMAN IO CONNECT GKxxx/NOADAPTER/DRIVER=SYS$GKDRIVER.EXE  
  
VAX - $ MCR SYSGEN CONNECT GKxxx/NOADAPTER/DRIVER=GKDRIVER
```

and the device name must begin with GK.

### 10.5.13 Slot Count

For MRD jukeboxes, the slot count is simply the number of slots (which can contain volumes) in the jukebox. Volumes reside in numbered slots when they are not in a drive. Slots are numbered from 0 to (slot count - 1). Filling in this field is optional: MDMS calculates the slot count by polling the jukebox firmware.

### 10.5.14 State

The state attribute is a protected field that describes the current state of the jukebox. A jukebox can be in one of three states:

- *Available* - Available for use, and not currently performing an operation
- *In-Use* - Currently performing a robot operation: robot operations occur sequentially; any new operation requested while the robot is in-use is queued
- *Unavailable* - The robot is unavailable for use for some reason

This field is normally maintained by MDMS, so you should not modify it unless a problem has occurred that needs manual cleanup (for example, the robot is stuck in the in-use state when it is clear that it is not in-use).

### 10.5.15 Threshold

MDMS provides the capability of monitoring the number of free volumes in a jukebox. A free volume is one that is available for allocation and writing new data. Many users would like to maintain a minimum number of free volumes in a jukebox to handle tape writing needs for some period of time. You can specify a threshold value of free volumes, below which an OPCOM message is issued that asks an operator move some more free volumes into the jukebox. In addition, the color status of the jukebox in MDMSView changes to yellow if the number of free volumes falls below the threshold, and to red if there are no free volumes in the jukebox. If you wish to disable threshold OPCOM messages and color status, set the threshold value to 0.

## Media Management

### 10.5 Jukeboxes

#### 10.5.16 Topology

The topology attribute specifies the physical configuration of a certain type of jukebox when it is being used with magazines. Topology is only useful when all of the following conditions are true:

- The jukebox is controlled by MRD
- The jukebox is in the TL820 class that allows you to open the jukebox door and insert entire magazines
- The jukebox is configured with towers, faces and levels

You specify the topology of the jukebox so that you can move magazines into and out of the jukebox by specifying a position rather than a start slot.

For each tower in the jukebox, you specify the number of faces in the tower, the number of levels in each face, and the number of slots in each level. For TL820-class jukeboxes, the typical values for each tower are 8 faces, 2 or 3 levels per face and 11 slots per level. The associated magazine contains 11 slots and fits into a position specified by tower, face and level. Other jukeboxes may vary.

#### 10.5.17 Usage

The usage attribute determines whether this jukebox is set up to use magazines, and has two values:

- *Magazine* - The jukebox is configured to use magazines
- *Nomagazine* - The jukebox is not configured to use magazines

You should only set usage to magazine if you plan to use MDMS magazine objects and move all the volumes in the magazines together. An alternative is to move individual volumes separately, even if they reside in a physical magazine; in this case set usage to nomagazine.

#### 10.5.18 Inventory Jukebox

MDMS provides the capability to inventory jukeboxes, and “discover” volumes in them and optionally create volumes in the MDMS database to match what was discovered. With this feature, you can simply place new volumes in the jukebox and let MDMS create the associated volume records with attributes that you can specify.

There are two types of inventory:

- Inventory using a vision system, which polls the jukebox’s firmware to locate volumes; this option is available for most larger library and silo type jukeboxes, and this operation takes only a few seconds to a few minutes depending on the size of the jukebox.
- Physical inventory, which actually loads volumes into drives to read volume labels. This is the only kind of inventory available for small loader-type jukeboxes that lack a vision system. This option is also available for larger jukeboxes, but is not recommended as it takes a considerable amount of time.

You can inventory whole jukeboxes, or specify a volume range or slot range, as follows:

- *Volume range* is supported for DCSC-controlled jukeboxes and MRD-based jukeboxes that have a vision system. Specify a range of volumes such as ABC001-ABC024. Up to 1000 volumes can be specified in a single range. When specifying a volume range, only those volumes are inventoried; other volumes in the jukebox are not.
- *Slot range* is available only for MRD-controlled jukeboxes, and can be applied to either vision or non-vision varieties. With slot range, only the specified slots are inventoried; other slots are not.

While inventorying jukeboxes, MDMS can find volumes that are defined and in the jukebox, that are not defined but are in the jukebox, and that are defined but missing from the jukebox. MDMS provides several options to handle undefined and missing volumes.

If you set the “Create” flag during an inventory, MDMS will create a volume record for each undefined volume it finds in the jukebox. You can specify in advance certain attributes to be applied to this volume record:

- *Inherit volume ID* - This is the most comprehensive option as it allows the new volume to inherit all non-protected fields from the specified volume. You normally use a volume known to be in the jukebox as the inherit volume ID.
- *Media type* - Assign this media type to the volume. If you use inherit and media type, the specified media type overrides the inherit media type
- *Preinitialized* - If you set this flag, the volume will be set to the free state and is immediately available for use. If you clear this flag, the volume will be set to the uninitialized state, and needs to be initialized prior to use. You should set or clear this flag depending on whether the volume is already physically initialized.

If you do not set the “Create” flag, then MDMS will not create new volume records for undefined volumes it finds.

Conversely, you can also define what to do if a volume that should be in the jukebox (according to the database) is found not to be in the jukebox. There are three options that you can apply using the “Missing” attribute:

- *Delete* - Delete the volume from the database; this is not normally what you would want to do because in most cases the volume is simply in another location and you probably want to keep it.
- *Ignore* - Do not change the database; this will probably leave the database in an inconsistent state, but you may prefer to perform the changes manually.
- *Move* - This is the default option, and changes the database to flag that the volume is in the volume’s onsite location.

When initiating an inventory from the DCL, you can choose a synchronous operation (default) or an asynchronous operation using the /NOWAIT qualifier. From MDMSView, an inventory is always asynchronous, so that you can continue performing other tasks.

## **10.6 Locations**

A location is an MDMS object that describes the physical location other objects. Nodes, jukeboxes, magazines, volumes and archives can all have locations associated with them. Locations are used for volume and drive allocation selection criteria, and for placing volumes and magazines in known labelled locations.

Locations can be hierarchical, and locations in hierarchy that have a common source are considered compatible locations. For example, locations SHELF1 and SHELF2 are compatible if they have a common parent location such as ROOM2. Compatible locations are used when allocating drives and volumes using selection criteria, so you should only define hierarchies to the extent that you wish compatible locations. Locations that extend beyond a room or floor are generally not considered compatible, so you should not normally build location hierarchies beyond that level.

## Media Management

### 10.7 Magazines

Locations can also contain “spaces”, that are normally labelled areas in a location that volumes and magazines can be placed in an onsite location. If a volume or magazine contains a space definition, this is output in OPCOM messages so that operator can easily locate a volume or magazine when needed.

Locations contain two attributes, as defined in the following sections.

#### 10.6.1 Parent Location

The parent location is an MDMS location object which is the next level up on the location hierarchy. For example, a location SHELF1 might have a parent location ROOM2, indicating that SHELF1 is in ROOM2. You should define a parent location only if you wish all locations belonging to the parent (including the parent itself) to be compatible when selecting volumes and drives. For example, in a hierarchy of SHELF1 and SHELF2 in ROOM2, volumes in any of the three locations would match a request to allocate a volume from ROOM2. Do not use the location hierarchy for other purposes.

#### 10.6.2 Spaces

Locations can contain spaces, that are used in OPCOM messages when volumes and magazines are being moved from one place to another. Enter a range of spaces in an alphanumeric range separated by a dash. Examples of space ranges are 1-10, A-Z, AAA001-AAA099, 10A-10Z.

## 10.7 Magazines

A magazine is an MDMS object that contains a set of volumes that are planned to be moved together as a group. It can also relate to physical magazines that some jukeboxes (most notably small loaders) require to move volumes into and out of the jukebox. Magazines can be moved into and out of MRD-controlled jukeboxes with all their volumes at once.

However, just because a jukebox requires a physical magazine does not necessarily mean that you must use MDMS magazines. The physical magazine jukebox can be handled without magazines, and volumes are moved individually as far as MDMS is concerned. The choice should depend on whether you wish the volumes to move independently (don't use magazines) or as a group together (use magazines).

Magazines are not supported for DCSC-controlled jukeboxes. Magazines have the following attributes.

#### 10.7.1 Jukebox, Start Slot and Position

The jukebox name contains the name of the jukebox if the magazine is in a jukebox. When in a jukebox, a magazine can optionally have a start slot or position, as follows:

- In a single-drive loader jukebox, only one magazine can be loaded at a time. In this case, the start slot is always zero, and the number of slots in the jukebox becomes the number of slots in the magazine.
- In larger, TL820-type jukeboxes, the magazine can be placed in many different places. If you have associated a topology with the jukebox, you can place the magazine in a “Position”, specified by a tower, face and level specification. This is easier to physically locate in such jukeboxes than the alternative, which is a start slot designation. OPCOM messages for Move Magazine operations will state either position or start slot depending on whether a topology was specified.

All three fields are protected and normally managed by MDMS when a “Move Magazine” operation occurs. Only manipulate these fields if an error occurs and you need to recover the database to a consistent state.

### 10.7.2 Onsite and Offsite Locations and Dates

When not in a jukebox, a magazine may be either in an onsite or offsite location. An onsite location is one where the magazine can be quickly accessed and moved into a jukebox, which is also onsite. An offsite location is meant to be a secure location in the case of disaster recovery, and generally does not have local access to a jukebox. However, nothing in MDMS precludes the possibility of offsite locations having their own jukeboxes.

Each magazine should have an onsite and offsite location defined, so that operators know where the magazine is physically located. They use these locations, the jukebox name and the placement to determine where a jukebox is at a certain time. Both onsite and offsite locations should be MDMS-defined location objects.

Together with the offsite and onsite locations, you can associate an offsite and onsite date. These dates represent the date the magazine is due to be moved offsite or onsite respectively. Typically, magazines are moved offsite while their volumes' data is still valid and needs to be protected in a secure location. When the volumes' data expires, the magazine should be scheduled to be brought onsite, so that the newly-freed volumes can be used for other purposes.

If an offsite and/or onsite date is specified, MDMS initiates the movement of the magazines at some point on the scheduled date automatically. This is performed by the "Move Magazine" scheduled operation, which by default runs at 1:00 am each day. Operators will see OPCOM messages to move the magazines to either the onsite or offsite location.

If you do not wish to have MDMS move magazines automatically, either remove the onsite and offsite dates from the magazine, or disable the scheduled "Move Magazine" activity by assigning a zero time to its schedule object "MDMS\$MOVE\_MAGAZINES".

### 10.7.3 Slot Count

The slot count specifies how many slots are in the magazine. Unlike jukeboxes, this value is required to make magazines work properly.

### 10.7.4 Spaces

While in an onsite location, the magazine can occupy a space, which is a labelled part of a location that uniquely identifies where the magazine is. A space can be designed to handle a single volume, but since magazines hold multiple volumes, multiple spaces can also be assigned. Enter either a space or a range of spaces for the magazine.

### 10.7.5 Move Magazine(s)

The supported way to move magazines from one place to another is to use the "Move Magazine" operation. You can move magazines on demand by issuing this operation, or you can let MDMS automatically move magazines according to pre-defined onsite or offsite dates (this is called a "scheduled" move). You can also force an early scheduled move if you want it to occur before the time that MDMS would initiate the move. Moving magazines into jukeboxes must always be performed manually.

When initiating a "Move Magazine", you can choose a destination for the magazine if the move is not a scheduled move. The destination can be one of three types of places:

- *Jukebox* - You wish to move the magazine and all of its volumes into a jukebox; you would then specify the jukebox name. If the jukebox is a large TL820-type jukebox, you must also specify the "Position", using tower, face and level, or start slot for the magazine.
- *Onsite location* - You wish to move the magazine to a location that is onsite to the computer hardware that normally uses it. You would then specify the onsite location name, and optionally one or more spaces that the magazine (or volumes from the magazine) will occupy.

## Media Management

### 10.8 Media Types

- *Offsite location* - You wish to move the magazine to an offsite location for safety in case of a disaster. Specify an offsite location name.

If you wish to force a scheduled move, you can select “Scheduled”. In most cases, the destination is predefined, so you don’t need to specify it. However, you can specify an alternative destination for the scheduled move if you wish by specifying a destination as outlined above.

Finally, you can specify if you need operator assistance. This is recommended with “Move Magazine” as magazines cannot be moved without human intervention. Only if you plan to do the physical move yourself or you manually let someone know would you disable operator assistance.

### 10.8 Media Types

MDMS uses media type objects to hold information about the type of media that volumes and drives can support. MDMS uses media type as a major selection criterion for allocating volumes and drives, and volumes can only be loaded into drives with compatible media types.

Media types contain four attributes, as defined in the following sections.

#### 10.8.1 Capacity

The capacity attribute indicates the capacity of the media in MB. This field is not used by ABS or HSM, but is used by the obsolete product “Sequential Media Filesystem” (SMF).

#### 10.8.2 Compaction

This important field indicates whether you wish the tape to be written with firmware compaction. Enabling compaction usually doubles the capacity of the tape, so this is a desirable option which is set by default. Clear the attribute if you do not wish compaction.

#### 10.8.3 Density

This field indicates the density of the tape that you desire. Many types of tape media (especially DLT tapes) support multiple densities, and certain types of drive can either read and write a certain density, or just read some densities. As such, you can define many media types with different densities that can be assigned to volumes and drives.

MDMS uses the density field when initializing volumes, so the density must be a valid OpenVMS density for the version of the operating system being used. Issue a “HELP INITIALIZE /DENSITY” command to determine the valid densities on the platform.

#### 10.8.4 Length

The length field is used for information purposes only. If your media comes in various lengths, you can differentiate between types by using the length field. Specify an integer value that has meaning to your operators.

### 10.9 Node

An MDMS node is an OpenVMS system that is running MDMS. All nodes running MDMS must have a node object defined in the database for MDMS to work properly. The node name must be the DECnet Phase IV name of the system, if DECnet Phase IV is running or a Phase IV alias is used. Otherwise it can be any name.

Nodes contain attributes as outlined in the following sections.



### 10.9.1 Database Server

MDMS operates as a group of co-operating processes running on multiple nodes in multiple clusters in an MDMS domain. One of these MDMS processes is known as the “Database Server”, and it actually controls all MDMS operations in the domain. Although only one node is the database server at any one time, you should enable multiple nodes to be *possible* database servers in case the actual database server node fails. In this way, failover is supported.

A database server must have direct access to the database files located in MDMS\$DATABASE\_LOCATION. Direct access, access via MSCP, and access via Fibre Channel are all considered local access. Access via a network protocol or DFS are not considered local access. It is recommended that you enable at least 3 nodes as potential database servers to ensure failover capabilities.

### 10.9.2 Disabled

Set to disable the node as an MDMS node. Clear to enable the node as an MDMS node.

### 10.9.3 OPCOM Class

You can specify the OPCOM classes to be used by MDMS for operator messages on this node. By default, the domain default OPCOM classes are used, but you can override this on a node-by-node basis. Specify one or more of the standard OpenVMS OPCOM classes - messages are directed to all login sessions with these OPCOM classes enabled.

### 10.9.4 Transports and Full Names

You can define which network transports are defined for this node. There are four choices:

- *DECnet* - The DECnet transport is used
- *TCPIP* - The TCP/IP transport is used, and the TCP/IP full name is specified
- *DECnet, TCPIP* - The DECnet and TCP/IP transports can be used, with DECnet preferred
- *TCPIP, DECnet* - The TCP/IP and DECnet transports can be used, with TCP/IP preferred

If you identify TCP/IP as a supported transport, you must define the TCP/IP fullname in the TCP/IP fullname field. These fullnames are normally in the format “node.loc.org.ext”. For example, SLOPER.CXO.CPQCORP.COM

If you identify DECnet as a transport, you need to specify a DECnet full name only if you are using DECnet-Plus (Phase V). In this case, enter the full name, which is normally in a format such as LOCAL:.node. If you are running DECnet Phase IV, do not specify a DECnet full name. The node’s node name is used.

## 10.10 Pools

A pool is a logical MDMS object that associates a set of volumes with a set of users that are authorized to use those volumes. Every volume can be assigned one pool, for which we say that the volume is in the pool. The pool is then assigned a set of users that are authorized to use the volumes in the pool. If a volume does not have a pool specified, then it is said to belong to the “scratch pool” for which no authorization is required.

Pools have three attributes that are discussed in the following sections.

## Media Management

### 10.11 Volumes

#### 10.10.1 Authorized Users

You can specify a list of authorized users for the pool, as a comma-separated list of users. Each user should be specified as `node::username` or `group::username`, where both the node/group and username portions can contain wildcard characters (`*%`). To authorize everyone, you can specify `::*`. To authorize everyone on a node you can specify `nodename::*`. Everyone in the authorized user list is allowed to allocate volumes in the pool. Other users require `MDMS_ALL_RIGHTS` or `MDMS_ALLOCATE_ALL` rights.

#### 10.10.2 Default Users

Default users are authorized like the authorized users, but in addition are assigned this pool as their default pool. In this case, if they attempt to allocate a volume and don't specify a pool, they will allocate a volume from this pool. A particular user need only appear in one list: they do not need to be listed in both lists to be an authorized user to their default pool.

#### 10.10.3 Threshold

Pools are useful for dividing volumes between groups or organizations, but they are only useful if there are free volumes in the pool. MDMS provides the capability of monitoring the number of free volumes in a pool. A free volume is one that is available for allocation and writing new data. Many users would like to maintain a minimum number of free volumes in a pool to handle tape writing needs for some period of time. You can specify a threshold value of free volumes, below which an OPCOM message is issued that asks an operator add some more free volumes to the pool. In addition, the color status of the pool in MDMSView changes to yellow if the number of free volumes falls below the threshold, and to red if there are no free volumes in the pool. If you wish to disable threshold OPCOM messages and color status, set the threshold value to 0.

### 10.11 Volumes

A volume is a physical piece of tape media that contains (or will contain) data written by MDMS applications (ABS or HSM), or user applications. Volumes have many attributes concerning their placement, allocation status, life-cycle dates, protection attributes and many other things.

Volume records can be created manually with a "Create Volume" operation, or automatically by MDMS with "Inventory Jukebox" and "Load Drive" operations. The `MDMS$CONFIGURE` command procedure can also be used to create volumes.

Once a volume is created it acquires a state. This state determines how the volume may be used at any time, and to an extent where the volume should be placed.

The following figure illustrates the life cycle of volumes, and the following table indicates how a volume transitions from one state to another.

Figure 10–1 Volume State

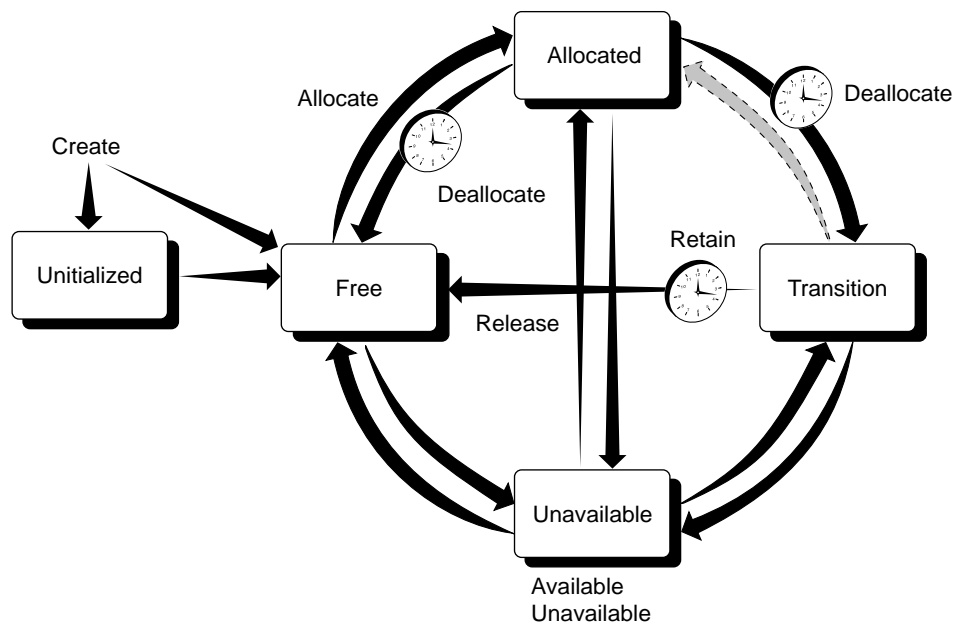

CXO6756A

Each row describes an operation with current and new volume states, commands and GUI actions that cause volumes to change states, and if applicable, the volume attributes that MDMS uses to cause volumes to change states. Descriptions following the table explain important aspects of each operation.

Table 10–1 MDMS Volume State Transitions

Current State	Transition to New State	New State
Blank	MDMS CREATE VOLUME Volume Create	UNINITIALIZED
Blank	MDMS CREATE VOLUME/PREINIT	FREE
UNINITIALIZED	MDMS INITIALIZE VOLUME Volume Initialize	FREE
FREE	MDMS INITIALIZE VOLUME Volume Initialize	FREE
FREE	MDMS ALLOCATE VOLUME Volume Allocate	ALLOCATED
ALLOCATED	MDMS DEALLOCATE VOLUME Volume Deallocate or automatically on the volume scratch date	TRANSITION
ALLOCATED	MDMS DEALLOCATE VOLUME Volume Deallocate or automatically on the volume scratch date	FREE

## Media Management

### 10.11 Volumes

**Table 10–1 MDMS Volume State Transitions**

Current State	Transition to New State	New State
TRANSITION	MDMS SET VOLUME /RELEASE Volume Release or automatically on the volume transition time	FREE
Any State	MDMS SET VOLUME /UNAVAILABLE Volume Unavailable	UNINITIALIZED
UNINITIALIZED	MDMS SET VOLUME /AVAILABLE Volume Available	Previous State
UNINITIALIZED	MDMS DELETE VOLUME Volume Delete	BLANK
FREE	MDMS DELETE VOLUME Volume Delete	BLANK

The following sections describes all the volume attributes in detail, followed by operations that you can perform on volumes.

#### 10.11.1 Allocation Fields - Account, Username, UIC and Job

The account, username and UIC fields are filled in automatically when a volume is allocated, and reflect the calling user or specified user during the allocate. The username is a valid Open-VMS username on the client system performing the allocate, and the account and UIC is from the user's entry in the system Authorization (UAF) file.

These fields are normally maintained by MDMS and are protected fields. You should not modify these fields unless the volume is deallocated. MDMS maintains the Account, Username and UIC in the volume even after the volume is deallocated, so that you can "retain" the volume back to the allocated state in case of accidental deallocation.

The job name field is not used by ABS, HSM or MDMS.

#### 10.11.2 Allocation and Movement Dates

There are several dates that maintain or control allocation and movement dates for volumes. These are as follows:

- Allocation Date - This is the date that the volume was last allocated using the "Allocate Volume" function. This field is protected and maintained by MDMS and should not normally be manually changed.
- Scratch date - This is the date the volume is due to be deallocated. MDMS will automatically deallocate the volume on the scratch date, but you can manually deallocate the volume before the scratch date as needed.
- Deallocation Date - This is the date the volume is actually deallocated. The volume may go into either the transition state or the free state depending on whether there is a transition time on the volume. This field is protected and maintained by MDMS and should not normally be manually changed.
- Onsite Date - This is the date the volume is due to be moved onsite from an offsite location. If this date is specified, MDMS automatically generates a "Move Volume" operation to move the volume onsite. Clear this field if you do not wish MDMS to automatically move the volume onsite.

- **Offsite Date** - This is the date the volume is due to be moved offsite. If this date is specified, MDMS automatically generates a “Move Volume” operation to move the volume offsite. Clear this field if you do not wish MDMS to automatically move the volume offsite.
- **Transition Time** - The transition time indicates that the volume is to enter the transition state when it is deallocated and remain in this state until the transition time has expired. In the transition state, the volume cannot be allocated for use. When the transition time expires, the volume enters the free state and may be re-used.

If an offsite and/or onsite date is specified, MDMS initiates the movement of the volumes at some point on the scheduled date automatically. This is performed by the “Move Volumes” scheduled operation, which by default runs at 1:00 am each day. Operators will see OPCOM messages to move the volumes to either the onsite or offsite location.

If you do not wish to have MDMS move volumes automatically, either remove the onsite and offsite dates from the volume, or disable the scheduled “Move Volumes” activity by assigning a zero time to its schedule object “MDMS\$MOVE\_VOLUMES”.

### **10.11.3History Dates**

The history dates are maintained by MDMS, but are for information purposes only. MDMS does not use these dates to perform any operations. The following history dates are maintained:

- **Creation Date** - The date the volume was created in the database. This field is protected and maintained by MDMS and should not normally be manually changed.
- **Initialize Date** - The date the volume was last initialized. This field is protected and maintained by MDMS and should not normally be manually changed.
- **Freed Date** - This is the date the volume was last freed, either directly on deallocation, or upon expiration of the transition time. This field is protected and maintained by MDMS and should not normally be manually changed.
- **Last Access Date** - The date the volume was last loaded (and presumably accessed). This field is protected and maintained by MDMS and should not normally be manually changed.
- **Cleaned Date** - If the volume is a cleaning volume, MDMS updates the cleaned date to reflect the date that the volume was last used for cleaning. Otherwise it is set to the creation date.
- **Purchase Date** - The date the volume was purchased. MDMS makes this the same values as the creation date, but you can adjust this if needed.

### **10.11.4State**

The state field indicates where in a volume’s life cycle the volume exists. The state field itself is protected, and you should not normally adjust it unless an error occurs. However, you can “Update State” using certain keywords, which checks for validity and results in a consistent database state.

A volume can be in one of the following states, which are shown in normal life-cycle order:

- *Uninitialized* - The default state when a volume is created. This state indicates that the volume needs to be initialized prior to use, and cannot be allocated until then.
- *Free* - When a volume is initialized, and after it has been freed, the volume is in the free state. This means that the volume’s data (if any) is no longer valid and can be used to write new data. This is the only state from which a user can allocate a new volume for use.
- *Allocated* - After a volume is allocated, it enters the allocated state. It remains in this state until the scratch date is reached. MDMS automatically deallocates the volume when the

## Media Management

### 10.11 Volumes

scratch date is reached, and it transitions to either the transition state (if there is a transition time on the volume) or the free state.

- *Transition* - If a volume is deallocated to the transition state, it remains in this state until the transition time expires. At this point, the volume re-enters the free state.
- *Unavailable* - This state is used by MDMS if it detects a problem with the volume. For example, if MDMS cannot read the label on this volume during a load, it puts it in the unavailable state. MDMS remembers the previous state (the “Available State”), so that when it comes out of the unavailable state, it goes back to its previous state.

A picture showing the normal state transitions is provided at the top of the volumes section.

While changing the state directly is not recommended, there are several options for changing state that are supported:

- *Available* - This changes the state from the unavailable state to the volume’s previous state
- *Unavailable* - This changes the current state to unavailable, and remembers the volume’s previous state. The volume cannot be used in this state. You should set this if you believe the volume is corrupted or broken and cannot be used.
- *Release* - If the volume is in the Transition State and you have verified that its data has expired, you can “Release” it to the free state immediately.
- *Retain* - If the volume is in the Transition State and you have verify that its data has NOT expired and is still useful, you can “Retain” the volume back to the allocated state. The existing allocated user, UIC and account are maintained. If the volume was in a volume set, the volume set is re-created.
- *Preinitialize* - If you know that the volume is already initialized, and the volume is in the Uninitialized state, this changes it to the Free state. It does not change the state if the volume is in any other state.

#### 10.11.5Media Types

A volume’s media types define the type of media for the volume, and what potential compaction or density options the volume can support. As such, before a volume is initialized, it can potentially support many media types. However, once a volume is initialized, MDMS uses the density and compaction attributes from a media type to physically write the tape. As such, a volume should only support one media type at and after the first initialization.

If the volume is in the Uninitialized state, select one or more MDMS-defined media types for the volume. If the volume is in any other state, select a single media type. If no media type is specified, the domain default media type is used.

#### 10.11.6Pool

A pool contains a collection of volumes that can be used by a set of authorized users. To insert a volume into a pool, simply specify a pool name in the volume’s pool field. If not defined, the volume is placed in the “scratch pool”, and it can be allocated by any user. If the volume is in the free state, the number of free volumes in the pool is incremented.

#### 10.11.7Previous and Next Volumes

These read-only fields indicate if a volume is in a volume set, and what the previous and next volumes are in the set, relative to this volume. A volume set is created when a tape write operation reaches end-of-tape and a new tape is required to complete the operation. ABS and HSM bind the next volume to the current volume, and create a volume set.

These fields are manipulated by “Bind Volume” and “Unbind Volume” operations, both manually and under control of MDMS applications.

### 10.11.8 Placement - Jukebox, Magazine, Locations, Drive

The placement fields of a volume indicate where the volume resides, and where it should reside when moved to an onsite or offsite locations. The placement attributes include the following:

- *Placement* - The current placement of the volume - options can be:
  - *Drive* - The volume is in a drive, indicated by the drive field
  - *Jukebox* - The volume is in a jukebox, indicated by the jukebox field and the slot field
  - *Magazine* - The volume is in a magazine, indicated by the magazine field and slot field
  - *Offsite* - The volume is in an offsite location, indicated by the offsite location field
  - *Onsite* - The volume is in an onsite location, indicated by the onsite location field, with optional space field
  - *Moving* - The volume is moving between one place and another

Placement is a protected field managed by MDMS. You should not change placement unless error recovery is needed.

- *Drive* - The name of the drive containing the volume. This field may contain a value even if the volume is not currently in a drive. The drive is a protected field managed by MDMS. You should not change drive unless error recovery is needed.
- *Jukebox* - The name of the jukebox containing the volume. The jukebox is a protected field managed by MDMS. You should not change jukebox unless error recovery is needed. The slot field indicates the jukebox slot the volume is in, and is filled in even if the volume is actually in a drive.
- *Magazine* - The name of the magazine containing the volume. The magazine is a protected field managed by MDMS. You should not change placement unless error recovery is needed. The slot field indicates the magazine slot the volume is in (this may or may not be the same as the jukebox slot). When the volume is in a magazine, its onsite and offsite location and date fields are invalid, as the magazine's onsite and offsite location and dates are used instead.
- *Offsite Location* - The designated offsite location for the volume (not valid if the volume is in a magazine)
- *Onsite Location* - The designated onsite location for the volume (not valid if the volume is in a magazine). The Space field indicates which space in the onsite location the volume is in or would be in if the placement is onsite.

### 10.11.9 Formats - Brand, Format, Block Factor, Record Size

The format fields are not used by ABS, HSM or MDMS, but can be used to document certain characteristics of the volume and its data format. The fields are as follows:

- *Brand* - The manufacturer of the volume - string
- *Format* - The record format used on the tape volume. Options are:
  - ASCII
  - BACKUP
  - EBCDIC
  - NONE
  - RMUBACKUP

## Media Management

### 10.11 Volumes

- *Record Size* - An integer
- *Block Factor* - An integer

#### 10.11.10 Protection

The protection field provides System, Owner, Group and World access protection for the volume. This protection is written to the volume when it is initialized, and provides protection from unauthorized use and re-initialization. The standard protection is:

```
SYSTEM(R, W) OWNER (R, W) GROUP (R) WORLD (None)
```

If protection is not set for the volume, the domain default protection is used.

#### 10.11.11 Counters

MDMS provides three counters for volumes, as follows:

- *Mount Count* - This is a count of the number of times the volume is loaded - maintained by MDMS and incremented every time MDMS loads this volume
- *Error Count* - Not maintained by MDMS - set this field any integer you wish
- *Times Cleaned* - If the volume is a cleaning volume, this value is incremented each time the volume is loaded and used for cleaning. Otherwise it is set to 0.

#### 10.11.12 Allocate Volume

You allocate volumes so that you can use them for writing new data. Allocating a volume places it into the Allocated state, and assigns the calling user (or specified user), UIC, and account in the allocation fields. This effectively reserves the volume to the user. The volume remains allocated to the user and unavailable for other use until the scratch date is reached, or unless the volume is manually deallocated.

When allocating a volume, you may specify the user for which you are allocating the volume (for example, ABS). If you do not specify a user, then you as the calling user are placed in the allocation fields.

Also, during allocation, you can change the following fields in the MDMS database to reflect the format to be used on the tape:

- *Format* - The record format used on the tape volume. Options are:
  - ASCII
  - BACKUP
  - EBCDIC
  - NONE
  - RMUBACKUP
- *Record Size* - An integer
- *Block Factor* - An integer
- *Scratch Date* - The date when the volume's data becomes obsolete and the volume should be deallocated - MDMS will automatically deallocate the volume at this time.
- *Transition Time* - When the volume is deallocated, the volume should go into the Transition State and remain in this state until the transition time expires, after which it will go into the Free State. If not specified, the volume goes into the Free State immediately on deallocation.



### 10.11.13 Allocate Volume(s) by Selection Criteria

Instead of allocating a volume by name, you can specify selection criteria to be used for MDMS to select a free volume for you and allocate it. You can also allocate a volume set by specifying a count of volumes to allocate. The allocation selection criteria include:

- *Media Type* - Select a volume with the specified media type
- *Location* - Used with media type, select a volume in the specified location
- *Jukebox* - Used with media type, select a volume in the specified jukebox
- *Pool* - Select a volume in the specified pool
- *Like Volume* - Select a volume like the specified volume (with the same media type, pool and placement)
- *Bind Volume* - Select a volume like the specified volume (with the same media type, pool and placement) and bind the new volume to the specified volume in a volume set

If you specify a volume count of more than one, then that many volumes will be allocated and placed in a volume set. If you also use the “Bind Volume” selection option, the new volume set is bound to the specified volume set.

You can also specify that you wish to change certain attributes of the volume as follows:

- *Format* - The record format used on the tape volume. Options are:
  - ASCII
  - BACKUP
  - EBCDIC
  - NONE
  - RMUBACKUP
- *Record Size* - An integer
- *Block Factor* - An integer
- *Scratch Date* - The date when the volume’s data becomes obsolete and the volume should be deallocated - MDMS will automatically deallocate the volume at this time.
- *Transition Time* - When the volume is deallocated, the volume should go into the Transition State and remain in this state until the transition time expires, after which it will go into the Free State. If not specified, the volume goes into the Free State immediately on deallocation.

### 10.11.14 Deallocate Volume

MDMS normally deallocates volumes when their scratch date expires. However, you can deallocate volumes manually in order to free them up earlier than planned. You can deallocate your own volumes, or with the appropriate rights deallocate volumes allocated to other users.

If the volume is in a volume set, the volume is also unbound from the volume set.

The following options are available when you deallocate a volume:

- *Deallocation State* - You can specify if the volume goes into the transition state or the free state on deallocation. The transition state disallows allocation until the transition time expires. You should make sure a transition time is specified, otherwise the domain default transition time is used. If you select the free state, the volume immediately goes into the free state.

## Media Management

### 10.11 Volumes

- *Transition Time* - If the deallocation state is set to Transition, this is the length of time the volume remains in the transition state. If not specified, the volume's existing transition time is used, or the domain default transition time is used.
- *User Name* - If the volume is allocated to a user other than yourself, you must specify that user name for the deallocation to occur. You need MDMS\_DEALLOCATE\_ALL for this option.
- *Deallocate Volume Set* - If the volume is in a volume set, the entire volume set is deallocated by default. You can avoid this by deallocating only the single volume clearing the volume set attribute. Note that the volume set is still unbound at the deallocated volume.

#### 10.11.15 Bind Volume

Binding volumes is the way to create volume sets, by binding one volume (or volume set) to another volume (or volume set). Normally, MDMS applications such as ABS and HSM perform automatic binding when they reach end-of-tape. However, it is sometimes necessary to perform manual binding. For example, if a volume set has been accidentally deallocated but is still needed, you may need to manually bind the set together (although the retain feature does this quite well).

There are only two options when binding a volume set:

- *Bind Volume ID* - The volume or volume set you wish to bind the current volume to. The current volume is always bound to the end of the specified volume set. Note that the allocated user of the volume set must match the allocated user of the current volume for the bind to be successful.
- *User Name* - If this volume is allocated to a different user than yourself, you must specify that user name. This requires the MDMS\_BIND\_ALL right.

When you bind a new volume to a volume or volume set, the new volume acquires the following attributes of the volume set:

- Onsite Date
- Offsite Date
- Scratch Date

The next and previous volumes are also updated appropriately.

#### 10.11.16 Unbind Volume

Unbinding a volume removes the volume from the volume set without deallocating it. When unbinding a volume you can choose whether to unbind the entire volume set, or break the volume set at the point of the unbind. You can also unbind on behalf of the allocated user.

There are only two options for unbind:

- *User Name* - If this volume is allocated to a different user than yourself, you must specify that user name. This requires the MDMS\_UNBIND\_ALL right.
- *Unbind Volume Set* - Set this flag if you wish to unbind the entire volume set (that is, none of the volumes will be in a volume set anymore). Clear the flag if you wish to unbind at the point of the current volume (that is, the volumes before and the volumes after will remain in two separate volume sets).

### 10.11.17 Load Volume

MDMS supports two ways to load volumes into drives:

- *Load Drive* - This loads a scratch volume into a drive via operator intervention or by stacker operation. As such, this option is only for standalone and stacker controlled drives
- *Load Volume* - This loads a specific volume into a drive, and can apply to all types of drive.

This section discusses the load volume option. The load drive option is discussed under drives.

When loading a specific volume, you normally need to specify the drive in which to load the volume, unless a drive has been specifically allocated for a volume (via DCL only). Select a drive with a compatible media type for the volume.

If you are loading a volume into a jukebox drive, and the volume is not in the jukebox, you can specify is an automatic “Move Volume” request to move the volume into the jukebox is desired. If you do not specify this option, and the volume is not in the jukebox, the operation will fail.

Another option is to request MDMS to check the volume label. This is normally a good idea as there can be mismatches between the volume’s magnetic label and its bar code label. If the labels do not match, the load fails. If you do not set the label check flag, the load may succeed but the label may be wrong. Use this option with caution.

When issuing the load volume request, you can specify whether the load is for read/write or read-only, and whether operator assistance is required.

You can also specify an alternative message for the operator. This is included in the OPCOM message instead of the normal MDMS operator message. Use of an alternative message is not recommended.

### 10.11.18 Unload Volume

You can unload a specific volume from a drive by issuing the “Unload Volume” operation. Unlike the “Unload Drive” operation which unloads any volume from the drive, the “Unload Volume” function checks the label on the volume on the drive before unloading it. If the label can be read and does not match the specified volume, the unload fails.

There is only one option for unload volume - operator assistance. This is recommended unless you are personally monitoring the unload operation.

### 10.11.19 Move Volume(s)

The supported way to move volumes from one place to another is to use the “Move Volume” operation. You can move volumes on demand by issuing this operation, or you can let MDMS automatically move volumes according to pre-defined onsite or offsite dates (this is called a “scheduled” move). You can also force an early scheduled move if you want it to occur before the time that MDMS would initiate the move. Moving volumes into jukeboxes or magazines must always be performed manually.

When initiating a “Move Volume”, you can choose a destination for the volume if the move is not a scheduled move. The destination can be one of four types of places:

- *Jukebox* - You wish to move the volume into a jukebox; you would then specify the jukebox name. You can also specify slot: this is required for small loader jukeboxes unless you perform an inventory afterwards. For vision-equipped jukeboxes, MDMS can determine an appropriate slot for the volume automatically.
- *Onsite location* - You wish to move the volume to a location that is onsite to the computer hardware that normally uses it. You would then specify the onsite location name, and optionally a space that the volume will occupy.

## Media Management

### 10.11 Volumes

- *Offsite location* - You wish to move the volume to an offsite location for safety in case of a disaster. Specify an offsite location name.
- *Magazine* - You wish to move the volume into a magazine, and specify a magazine slot for the volume.

If you wish to force a scheduled move, you can select “Scheduled”. In most cases, the destination is predefined, so you don’t need to specify it. However, you can specify an alternative destination for the scheduled move if you wish by specifying a destination as outlined above.

Finally, you can specify if you need operator assistance. This is recommended with “Move Volume” because human intervention is necessary to move volumes. Only if you plan to do the physical move yourself or you manually let someone know would you disable operator assistance.

#### 10.11.20 Initialize Volume(s)

MDMS supports initialization of volumes to make them available for use. Initializing a volume consists of writing an ANSI label on the volume, and applying compaction and density attributes and the volume protection field in the label. The volume is then free to be written. If the volume was in the Uninitialized state, it will now change to the Free state. All volumes need to be initialized at least once before ABS and HSM can allocate and use them.

Volumes that are already written need to be initialized again if you wish to use the whole volume for writing again. Both ABS and MDMS initialize volumes on every allocation.

When initializing volumes, you can specify four options:

- *Media Type* - If the volume does not have a media type specified, or has more than one media type specified, this is the time to specify a single media type for the volume. This is because the initialize instantiates the density and compaction attributes of the media type when writing to the volume.
- *Operator Assistance* - Recommended if a problem occurs during loading/unloading during the initialization.
- *Overwrite* - If set, this indicates that you wish the volume label to be written regardless of the label currently on the tape. If clear, the initialize will not take place if there is a different label on the tape.

---

## MDMS Configuration

The Installation Guide provides information about establishing the MDMS domain configuration. The information in this chapter goes beyond the initial configuration of MDMS, explaining concepts in more detail than the product installation and configuration guide. This chapter also includes procedures related to changing an existing MDMS configuration.

The major sections in this chapter focus on the MDMS domain and its components, and the devices that MDMS manages.

A sample configuration for MDMS is shown in Appendix B.

### 11.1 The MDMS Management Domain

To manage drives and volumes, you must first configure the scope of the MDMS management domain. This includes placing the database in the best location to assure availability, installing and configuring the MDMS process on nodes that serve ABS V3 or HSM V3 and defining node and domain object record attributes. The MDMS Domain is defined by:

- the MDMS database
- start up files on the nodes which access it
- node and domain object records

# MDMS Configuration

## 11.1 The MDMS Management Domain

Figure 11–1 The MDMS Domain

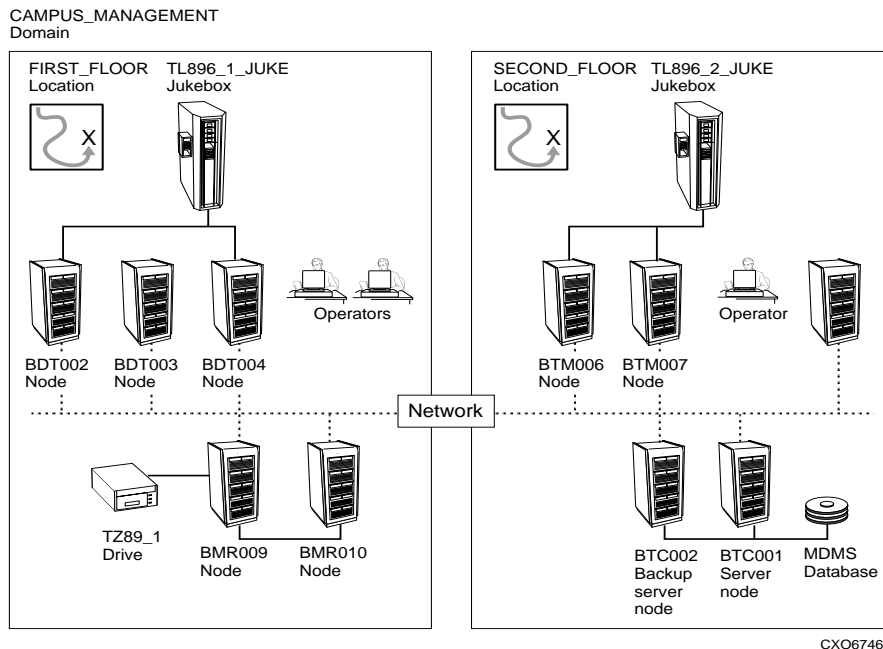

Understanding MDMS configuration concepts is necessary to configure a reliable and available service

### 11.1.1 The MDMS Database

The MDMS database is a collection of OpenVMS RMS files that store the records describing the objects you manage. lists the files that make up the MDMS database.

Table 11–1 MDMS Database Files and Their Contents

Database File	Object Records
MDMS\$DOMAIN_DB.DAT	The only Domain object record
MDMS\$DRIVE_DB.DAT	All Drive object records
MDMS\$GROUP_DB.DAT	All Group object records
MDMS\$JUKEBOX_DB.DAT	All Jukebox object records
MDMS\$LOCATION_DB.DAT	All Location object records
MDMS\$MAGAZINE_DB.DAT	All Magazine object records
MDMS\$MEDIA_DB.DAT	All Media Type object records
MDMS\$NODE_DB.DAT	All Node object records
MDMS\$POOL_DB.DAT	All Pool object records
MDMS\$VOLUME_DB.DAT	All Volume object records

### **11.1.1.1 Database Performance**

If you are familiar with the structure of OpenVMS RMS files, you can tune and maintain them over the life of the database. You can find File Definition Language (FDL) files in the MDMS\$ROOT:[SYSTEM] directory for each of the database files. Refer to the OpenVMS Record Management System documentation for more information on tuning RMS files and using the supplied FDL files.

### **11.1.1.2 Database Safety**

MDMS keeps track of all objects by recording their current state in the database. In the event of a catastrophic system failure, you would start recovery operations by rebuilding the system, and then by restoring the important data files in your enterprise. Before restoring those data files, you would have to first restore the MDMS database files.

Another scenario would be the failure of the storage system on which the MDMS files reside. In the event of a complete disk or system failure, you would have to restore the contents of the disk device containing the MDMS database.

The procedures in this section describe ways to create backup copies of the MDMS database. These procedures use MDMS\$SYSTEM:MDMS\$COPY\_DB\_FILES.COM command procedure. This command procedure copies database files with the CONVERT/SHARE command. The procedure in Table 11–2 describes how to copy MDMS database files only. The procedure in Table 11–3 describes how to process the MDMS database files when they are copied as part of an image backup on the disk device.

#### **To Make Backup Copies of the MDMS Database**

The procedure outlined in describes how you can make backup copies of just the MDMS database files using the OpenVMS Backup Utility. This procedure does not account for other files on the device.

## MDMS Configuration

### 11.1 The MDMS Management Domain

**Table 11–2 How to Back Up the MDMS Database Files**

Step...	Action...
1.	Prepare for making back up copies by finding a disk with enough available space to temporarily hold a copy of each file in the MDMS database.
2.	Determine a time of relative inactivity by MDMS clients, ABS or HSM.  For ABS, this could be a few hours after the completion of system backups.  For HSM, this is more difficult to determine because a shelving policy could be activated at any time.  If necessary, shut down ABS and/or HSM to make sure there are no requests of MDMS.
3.	<hr/> <p style="text-align: center;"><b>Note</b></p> <hr/> <p><b>If you cannot shut down HSM or ABS, when running MDMS\$COPY_DB_FILES.COM, it is possible an update to the database file can occur after it has been opened. This can create a possibility that the copy of the database file will be out of synchronization with other database files.</b></p> <hr/> <p>At the determined time, copy the MDMS database files with the supplied command procedure MDMS\$COPY_DB_FILES.COM.</p> <pre style="text-align: center;">\$ @MDMS\$ROOT:[TOOLS]MDMS\$COPY_DB_FILES</pre> <p>After the MDMS\$COPY_DB_FILES command procedure ends, copies of the database files reside on the same disk as the original files.</p>
4.	Use the OpenVMS Backup Utility to create a back up copy of the database files. You must have at least one tape device configured to be shared with applications other than MDMS. The following shows an example BACKUP command:  <pre style="text-align: center;">\$BACKUP MDMS\$DATABASE_LOCATION:*.DAT_COPY tape_device_name</pre>
5.	After the OpenVMS Backup Utility operation completes, delete the file copies from the database directory.
6.	Store the copies of the MDMS database in a safe location.

#### To Process the MDMS Database for an Image Backup of the Device

The procedure in shows how to process the MDMS database files for an image backup. The image backup could be part of a periodic full backup and subsequent incremental. This procedure also describes how to use the files in case you restore them.



**Table 11–3 Processing MDMS Database Files for an Image Backup**

Step...	Action...
1.	<p>Create a preprocessing command procedure to execute before the image backup on the disk. The command procedure must first purge old database file copies from the directory, then creates a new set of copies.</p> <pre style="margin-left: 40px;">\$PURGE MDMS\$DATABASE_LOCATION:*.DAT_COPY \$@MDMS\$SYSTEM:MDMS\$COPY_DB_FILES</pre>
2.	<p>Plan the backup operation on the disk containing the MDMS database files, to make sure that the preprocessing command procedure executes before the actual backup procedure.</p>
3.	<p>Run the backup operation. Each time you create a backup copy of the disk, you will get a consistent copy of the MDMS database files.</p>
4.	<p>When you need to restore the data to the device, you need to use the consistent files. Rename the .DAT_COPY files to become the .DAT files, then purge the .DAT files from the directory.</p> <pre style="margin-left: 40px;">\$RENAME MDMS\$DATABASE:*.DAT_COPY MDMS\$DATABASE:*.DAT \$PURGE MDMS\$DATABASE</pre>

### 11.1.1.3 Moving the MDMS Database

In the event the disk device on which you keep the MDMS database runs out of space, you have the option of moving the MDMS database, or moving other files off the device. The procedure described in this section explains the actions you would have to perform to move the MDMS database. Use this procedure first as a gauge to decide whether moving the MDMS database would be easier or more difficult than moving the other files. Secondarily, use this procedure to relocate the MDMS database to another disk device. Table 11–4 describes how to move the MDMS database to a new device location.

## MDMS Configuration

### 11.1 The MDMS Management Domain

**Table 11–4 How to Move the MDMS Database.**

Step...	Action...
1.	Shut down any applications using MDMS: ABS or HSM. Refer to the respective application documentation for specific commands.
2.	Shut down the MDMS process on all nodes in the domain.
3.	Using the OpenVMS Backup Utility, create a copy of the database files. Use the CRC and VERIFY options to help ensure your copy is valid.
4.	Using the OpenVMS Backup Utility, restore the copy of the database files into the new location. Use CRC and VERIFY options to ensure the restored copy is valid.
5.	In every MDMS start up file SYSS\$MANAGER:MDMS\$\$SYSTARTUP.COM, define the MDMS\$DATABASE_FILES logical to point to the new location.
6.	Start up MDMS on a node enabled as a database server.
7.	From the node, make sure you can access the database by entering an MDMS SHOW command to examine a record from each database file.  If you get an error, first check to make sure that the logical assignment for the MDMS\$DATABASE_FILES is correct.  If the logical assignment is correct, then you will have to determine why the files are not accessible.
8.	Start up the remaining MDMS nodes.
9.	Keep the previous database files on-line, until you know the new database files are accessible.
10.	After you are certain the new database files are accessible, delete the original files.

#### 11.1.2 The MDMS Process

This section describes the MDMS software process, including server availability, interprocess communication, and start up and shut down operations.

##### 11.1.2.1 Server Availability

Each node in an MDMS domain has one MDMS server process running. Within an MDMS domain only one server will be serving the database to other MDMS servers. This node is designated as the *MDMS Database Server*, while the others become *MDMS clients*. Of the servers listed as database servers, the first one to start up tries to open the database. If that node can successfully open the database, it is established as the database server. Other MDMS servers will then forward user requests to the node that has just become the database server.

Subsequently, if the database server fails because of a hardware failure or a software induced shut down, the clients compete among themselves to become the database server. Whichever client is the first to successfully open the database, becomes the new database server. The other clients will then forward user requests to the new database server. User requests issued on the node which is the database server, will be processed on that node immediately.

### 11.1.2.2 The MDMS Account

During installation you create the MDMS user account as shown in Example 11–1. This account is used by MDMS for every operation it performs.

#### Example 11–1 MDMS User Account

```

Username:          MDMS$SERVER          Owner:  SYSTEM MANAGER
Account:          SYSTEM                UIC:   [1,4] ([SYSTEM])
CLI:             DCL                    Tables:
Default:SYS$SYSROOT:[SYSMGR]
LGICMD:SYS$LOGIN:LOGIN
Flags: DisForce_Pwd_Change DisPwdHis
Primary days:    Mon Tue Wed Thu Fri Sat Sun
Secondary days:
No access restrictions
Expiration:      (none)                Pwdminimum: 14      Login Fails:      0
Pwdlifetime:    30 00:00                Pwdchange: 08-Apr-2002 12:19
Maxjobs:        0                       Fillm: 500          Bytlim: 100000
Maxacctjobs:    0                       Shrfillm: 0         Pbytlim: 0
Maxdetach:      0                       BIOlm: 10000        JTquota: 4096
Prclm:          10                      DIOLm: 300          WSdef: 5000
Prio:           4                       ASTlm: 300          WSquo: 10000
Queprio:        0                       TQElm: 300          WSextent: 30000
CPU:            (none)                  Enqlm: 2500         Pgflquo: 300000
Authorized Privileges:
DIAGNOSE NETMBX PHY_IO READALL SHARE SYSNAM SYSPRV TMPMBX WORLD
Default Privileges:
DIAGNOSE NETMBX PHY_IO READALL SHARE SYSNAM SYSPRV TMPMBX WORLD

```

### 11.1.3 The MDMS Start Up File

MDMS creates the SYS\$STARTUP:MDMS\$SYSTARTUP.COM command procedure on the initial installation. This file includes logical assignments that MDMS uses when the node starts up. The installation process also offers the opportunity to make initial assignments to the logicals.

If you install MDMS once for shared access in an OpenVMS Cluster environment, this file is shared by all members. If you install MDMS on individual nodes within an OpenVMS Cluster environment, this file is installed on each node.

In addition to creating node object records and setting domain and node attributes, you must define logicals in the MDMS start up file. These are all critical tasks to configure the MDMS domain.

Table 11–5 provides brief descriptions of most of the logical assignments in MDMS\$SYSTARTUP.COM. More detailed descriptions follow as indicated.

## MDMS Configuration

### 11.1 The MDMS Management Domain

**Table 11–5 MDMS\$SYSTARTUP.COM Logical Assignments**

Logical Name	Assignment
MDMS\$DATABASE_SERVERS	List of all nodes that can run as the MDMS database server. See Section 11.1.3.1 for more information.
MDMS\$ROOT	Device and directory of MDMS files.
MDMS\$LOGFILE_LOCATION	Device and directory of the MDMS log file. See Section 11.1.3.2 for more information.
MDMS\$DATABASE_LOCATION	Device and directory of the MDMS database files. All installations in any one domain must define this as a common location. Section 11.1.1 identifies the MDMS database files and describes how they should be managed.
MDMS\$TCPIP_SENDPORTS	Range of ports for the node to use for out going connections. The default range is for privileged ports; 1 through 1023.
MDMS\$SUPPORT_PRE_V3	Support for SLS/MDMS Version 2.9x clients. The default value is FALSE. If you need to support some systems running SLS/MDMS Version 2.9x, then set this value to TRUE.

#### 11.1.3.1 MDMS\$DATABASE\_SERVERS - Identifies Domain Database Servers

Of all the nodes in the MDMS domain, you select those which can act as a database server. Only one node at a time can be the database server. Other nodes operating at the same time communicate with the node acting as the database server. In the event the server node fails, another node operating in the domain can become the database server if it is listed in the MDMS\$DATABASE\_SERVERS logical.

For instance, in an OpenVMS Cluster environment, you can identify all nodes as a potential server node. If the domain includes an OpenVMS Cluster environment and some number of nodes remote from it, you could identify a remote node as a database server if the MDMS database is on a disk served by the Distributed File System software (DECdfs). However, if you do not want remote nodes to function as a database server, do not enter their names in the list for this assignment.

The names you use must be the full network name specification for the transports used. shows example node names for each of the possible transport options. If a node uses both DECnet and TCP/IP, full network names for both should be defined in the node object

---

#### Note

**When you specify the use of both DECnet and TCP/IP network transports in the configuration, you should include node names for each transport as appropriate. Specifying only one node name for a specific transport is allowable. However, when that node attempts to locate a database server on start up, only the transport for which the name applies will be used, thereby limiting reliability.**

---

**Table 11–6 Network Node Names for MDMS\$DATABASE\_NODES**

Network Transport	Node Name Examples
DECnet	NODE_A, NODE_B
DECnet Plus	SITE: .NODE_A.SITE, SITE: .NODE_B.SITE
TCP/IP	node_a.site.inc.com, node_b.site.inc.com

### 11.1.3.2 MDMS\$LOGFILE\_LOCATION

Defines the location of the Log Files. For each server running, MDMS uses a log file in this location. The log file name includes the name of the *cluster* node it logs.

For example, the log file name for a node with a *cluster* node name NODE\_A would be:

```
MDMS$LOGFILE_LOCATION:MDMS$LOGFILE_NODE_A.LOG
```

### 11.1.3.3 MDMS Shut Down and Start Up

#### How to Shut Down MDMS

To shut down MDMS on the current node enter this command:

```
$@SYS$STARTUP:MDMS$SHUTDOWN.COM
```

#### How to Restart MDMS

To restart MDMS (shut down and immediate restart), enter the shut down command and the parameter RESTART:

```
$@SYS$STARTUP:MDMS$SHUTDOWN RESTART
```

#### How to Start Up MDMS

To start up MDMS on the current node enter this command:

```
$@SYS$STARTUP:MDMS$STARTUP.COM
```

## 11.1.4 Managing an MDMS Node

The MDMS node object record characterizes the function of a node in the MDMS domain and describes how the node communicates with other nodes in the domain.

### 11.1.4.1 Defining a Node's Network Connection

To participate in an MDMS domain, a node object has to be entered into the MDMS database. This node object has 4 attributes to describe its connections in a network:

1. If the node is part of a DECnet (Phase IV) network, then the name of the node object must match exactly with the node's DECnet node name (i.e. SY\$\$NODE). Otherwise the name of the node object may be any character string up to 31 characters.
2. If the node is part of a DECnet-Plus (Phase V) network, the DECnet-Plus full name must be supplied as an attribute to the node object, using the /DECNET\_PLUS\_FULLNAME Qualifier or GUI equivalent.
3. If the node is part of an Internet or Intranet using TCP/IP, the TCP/IP full name must be supplied as an attribute to the node object, using the /TCPIP\_FULLNAME Qualifier or GUI equivalent.
4. Depending on which network or networks are available or should be used, the node's trans-

## MDMS Configuration

### 11.1 The MDMS Management Domain

port attribute has to be set to either DECNET, TCPIP or both.

When an MDMS server starts up it only has its network node name/s to identify itself in the MDMS database. Therefore if a node has a network node name but it is not defined in the *node object records* of the database, this node will be rejected as not being fully enabled. For example, a node has a TCP/IP name and TCP/IP is running but the node object record shows the TCP/IP full name as blank.

There is one situation where an MDMS server is allowed to function even if it does not have a node object record defined or the node object record does not list all network names. This is in the case of the node being an MDMS database server. Without this exception, no node entries can be created in the database. As long as a database server is not fully enabled in the database it will not start any network listeners.

#### 11.1.4.2 Defining How the Node Functions in the Domain

This section describes how to designate an MDMS node as a database server, enable and disable the node.

##### Designating Potential Database Servers

When you install MDMS, you must decide which nodes will participate as potential database servers. To be a database server, the node must be able to access the database disk device. Typically, in an OpenVMS Cluster environment, all nodes would have access to the database disk device, and would therefore be identified as potential database servers.

Set the database server attribute for each node identified as a potential database server. For nodes in the domain that are not going to act as a database server, negate the database server attribute.

##### Disabling and Enabling MDMS Nodes

There are several reasons for disabling an MDMS node.

- Preventing the node you are disabling from becoming the database server.
- Preventing applications and users on the node from issuing or processing MDMS requests.

Disable the node from the command line or the GUI and restart MDMS.

When you are ready to return the node to service, enable the node.

#### 11.1.4.3 Enabling Interprocess Communication

Nodes in the MDMS domain have two network transport options: one for DECnet, the other for TCP/IP. When you configure a node into the MDMS domain, you can specify either or both these transport options by assigning them to the transport attribute. If you specify both, MDMS will attempt interprocessor communications on the first transport value listed. MDMS will then try the second transport value if communication fails on the first.

If you are using the DECnet Plus network transport, define the full DECnet Plus node name in the decnet fullname attribute. If you are using an earlier version of DECnet, leave the DECnet-Plus fullname attribute blank.

If you are using the TCP/IP network transport, enter the node's full TCP/IP name in the TCPIP fullname attribute. You can also specify the receive ports used by MDMS to listen for incoming requests. By default, MDMS uses the port range of 2501 through 2510. If you want to specify a different port or range of ports, append that specification to the TCPIP fullname. For example:

```
node_a.site.inc.com:2511-2521
```

#### 11.1.4.4 Describing the Node

Describe the function, purpose of the node with the description attribute. Use the location attribute to identify the MDMS location where the node resides.

#### 11.1.4.5 Communicating with Operators

List the OPCOM classes of operators with terminals connected to this node who will receive OPCOM messages. Operators who enable those classes will receive OPCOM messages pertaining to devices connected to the node.

For more information about operator communication, see Section 12.2.

#### 11.1.5 Managing Groups of MDMS Nodes

MDMS provides the *group* object record to define a group of nodes that share common drives or jukeboxes. Typically, the group object record represents all nodes in an OpenVMS Cluster environment, when drives in the environment are accessible from all nodes.

Figure 11–2 Groups in the MDMS Domain

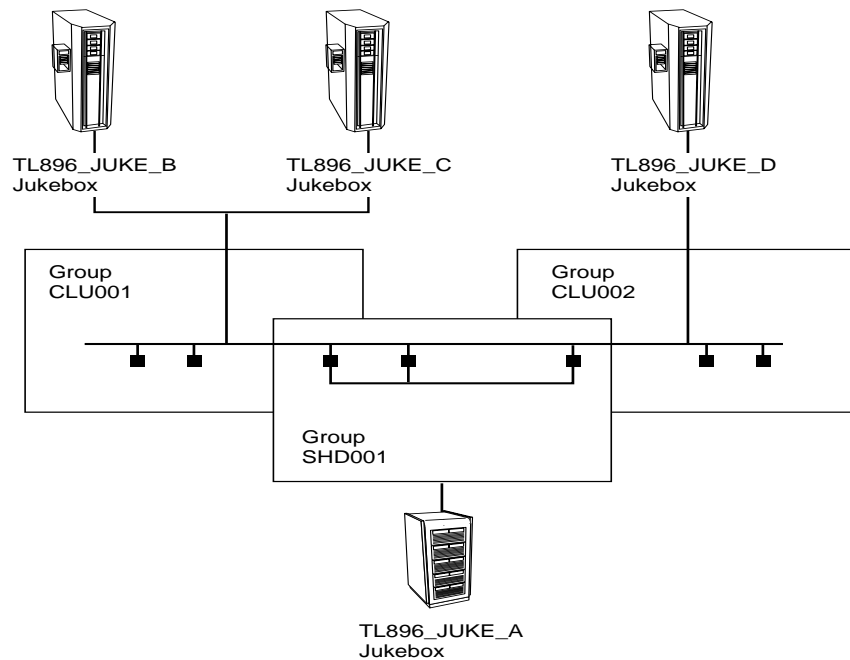

CXO6747A

Some configurations involve sharing a device between nodes of different OpenVMS Cluster environments. You could create a group that includes all nodes that have access to the device.

When you create a group to identify shared access to a drive or jukebox assign the group name as an attribute of the drive or jukebox. When you set the group attribute of the drive or jukebox object record, MDMS clears the node attribute.

The following command examples create a functionally equivalent drive object records.

```
#!These commands create a drive connected to a Group object
$MDMS CREATE GROUP CLUSTER_A /NODES=(NODE_1,NODE_2,NODE_3)
$MDMS CREATE DRIVE NODE$MUA501/GROUPS=CLUSTER_A
$!
```

## MDMS Configuration

### 11.1 The MDMS Management Domain

```
#!This command creates a drive connected to NODE_1, NODE_2, and NODE_3
$MDMS CREATE DRIVE NODE$MUA501/NODES=(NODE_1,NODE_2,NODE_3)
```

Figure 11–2 is a model of organizing clusters of nodes in groups and how devices are shared between groups.

#### 11.1.6 Managing the MDMS Domain

The domain object record describes global attributes for the domain and includes the description attribute where you can enter an open text description of the MDMS domain. Additional domain object attributes define configuration parameters, access rights options, and default volume management parameters. See Figure 11–1.

##### 11.1.6.1 Domain Configuration Parameters

###### Operator Communications for the Domain

Include all operator classes to which OPCOM messages should go as a comma separated list value of the OPCOM classes attribute. MDMS uses the domain OPCOM classes when nodes do not have their classes defined.

For more information about operator communication, see Section 12.2.

###### Resetting the Request Identifier Sequence

If you want to change the request identifier for the next request, use the request id attribute.

##### 11.1.6.2 Domain Options for Controlling Rights to Use MDMS

This section briefly describes the attributes of the domain object record that implement rights controls for MDMS users. Refer to Appendix on MDMS Rights and Privileges for the description of the MDMS rights implementation.

###### ABS Users

If you use MDMS to support ABS, you can set the ABS rights attribute to allow any user with any ABS right to perform certain actions with MDMS. This feature provides a short cut to managing rights by enabling ABS users and managers access to just the features they need. Negating this attribute means users with any ABS rights have no additional MDMS rights.

###### MDMS Client Applications

MDMS defines default low level rights for the application rights attribute according to what ABS and HSM minimally require to use MDMS.

---

###### Caution

---

**The ABS or HSM processes include the MDMS\_APPLICATION\_RIGHTS identifier which assumes the low level rights associated with it. Do not modify the low level rights for the domain application rights attribute. Changing the values to this attribute can cause your application to fail.**

---

###### Default Rights for Various System Users

If you want to grant all users certain MDMS rights without having to modify their UAF records, you can assign those low level rights to the default rights attribute. Any user without specific MDMS rights in their UAF file will have the rights assigned to the default rights identifier.

Use the operator rights attribute to identify all low level rights granted to any operator who has been granted the MDMS\_OPERATOR right in their UAF.

Use the SYSPRV attribute to allow any process with SYSPRV enabled the rights to perform any and all operations with MDMS.



## MDMS Configuration

### 11.1 The MDMS Management Domain

Use the user rights attribute to identify all low level rights granted to any user who has been granted the MDMS\_USER right in their UAF.

#### 11.1.6.3 Domain Default Volume Management Parameters

The MDMS domain includes attributes used as the foundation for volume management. Some of these attributes provide defaults for volume management and movement activities, others define particular behavior for all volume management operations. The values you assign to these attributes will, in part, dictate how your volume service will function. lists brief descriptions of these attributes.

**Table 11–7 Default Volume Management Parameters**

Attribute	Meaning
Offsite Location	MDMS uses this location for the volume and magazine offsite location unless another location is specified.
Onsite Location	MDMS uses this location for the volume and magazine onsite location unless another location is specified.
Maximum Scratch Time	This is the maximum amount of time that can be set as the scratch time on any volume in the domain.
Mail Users	A list of e-mail address for users or accounts to be notified when volumes are deallocated. Any email address on this list must be in syntax that the OpenVMS Mail Utility can process.
Deallocate State	Specifies whether a volume is immediately freed upon reaching the deallocation date, or if the volume is put into a transition state for temporary protection before being set free.
Transition Time	The amount of time a volume stays in the transition state.
Scratch Time	MDMS uses the time span specified here to set the default scratch date when MDMS allocates a volume.
Protection	The default protection for volumes allocated to ABS and MDMS. The format is the standard OpenVMS file protection specification format.

#### 11.1.7 MDMS Domain Configuration Issues

This section addresses issues that involve installing additional MDMS nodes into an existing domain, or removing nodes from an operational MDMS domain.

##### 11.1.7.1 Adding a Node to an Existing Configuration

Once you configure the MDMS domain, you might have the opportunity to add a node to the existing configuration. Table 11–8 describes the procedure for adding a node to an existing MDMS domain.

## MDMS Configuration

### 11.2 Configuring MDMS Drives, Jukeboxes and Locations

**Table 11–8 Adding a Node to an Existing Configuration**

Step...	Action...
1.	Create a node object record with either the CLI or GUI. Set the transport and network name attributes in accordance with available network options. For more information, see Section 11.1.4.3.
2.	Decide if the node will be a database server or will only function as an MDMS client. <ul style="list-style-type: none"><li>• If the node is to be a database server, set the database server attribute (default)</li><li>• If the node is not to be a database server, negate the database server attribute.</li></ul>
3.	Set the remaining node object attributes, then complete the creation of the node.
4.	If the node will not share an existing startup file and database server image, then install the MDMS software with the VMSINSTAL utility.
5.	If the new node is a database server, then add the node by its network transport names to the MDMS\$DATABASE_SERVERS list in all start up files in the MDMS domain.

#### 11.1.7.2 Removing a node from an existing configuration

When you remove a node from the MDMS domain, there are several additional activities you must perform after deleting the node object record.

- If the node was a database server, remove its node names from all MDMS start up files in the MDMS\$DATABASE\_SERVERS logical assignment.
- Remove any references to the node that might exist in remaining MDMS object records.
- Remove any references to the node that might exist in DCL command procedures.

## 11.2 Configuring MDMS Drives, Jukeboxes and Locations

MDMS manages the use of drives for the benefit of its clients, ABS and HSM. You must configure MDMS to recognize the drives and the locations that contain them. You must also configure MDMS to recognize any jukebox that contains managed drives.

You will create drive, location, and possibly jukebox object records in the MDMS database. The attribute values you give them will determine how MDMS manages them. The meanings of some object record attributes are straightforward. This section describes others because they are more important for configuring operations.

### 11.2.1 Configuring MDMS Drives

Before you begin configuring drives for operations, you need to determine the following aspects of drive management:

- How to describe the drive
- Which systems need access to the drive
- How the drive fits into your operations

#### 11.2.1.1 How to Describe an MDMS Drive

You must give each drive a name that is unique within the MDMS domain. The drive object record can be named with the OpenVMS device name, if desired, just as long as the name is not duplicated elsewhere.

## MDMS Configuration

### 11.2 Configuring MDMS Drives, Jukeboxes and Locations

Use the description attribute to store a free text description of anything useful to your management of the drive. MDMS stores this information, but takes no action with it.

The device attribute must contain the OpenVMS allocation class and device name for the drive. If the drive is accessed from nodes other than the one from which the command was entered, you must specify nodes or groups in the /NODE or /GROUP attributes in the drive record. Do not specify nodes or groups in the drive name or the device attribute.

If the drive resides in a jukebox, you must specify the name of the jukebox with the jukebox attribute. Identify the position of the drive in the jukebox by setting the drive number attribute. Drives start at position 0.

Additionally, the jukebox that contains the drives must also be managed by MDMS.

#### 11.2.1.2 How to Control Access to an MDMS Drive

MDMS allows you to dedicate a drive solely to MDMS operations, or share the drive with other users and applications. Specify your preference with the shared attribute.

You need to decide which systems in your data center are going to access the drives you manage.

Use the groups attribute if you created group object records to represent nodes in an OpenVMS Cluster environment or nodes that share a common device.

Use the nodes attribute if you have no reason to refer to any collection of nodes as a single entity, and you plan to manage nodes, and the objects that refer to them, individually.

The last decision is whether the drive serves locally connected systems, or remote systems using the RDF software. The access attribute allows you to specify local, remote (RDF) or both.

#### 11.2.1.3 How to Configure an MDMS Drive for Operations

Specify the kinds of volumes that can be used in the drive by listing the associated media type name in the media types attribute. You can force the drive to not write volumes of particular media types. Identify those media types in the read only attribute.

If the drive has a mechanism for holding multiple volumes, and can feed the volumes sequentially to the drive, but does not allow for random access or you choose not to use the random access feature, then you can designate the drive as a stacker by setting the stacker attribute.

Set the disabled attribute when you have to exclude the managed drive from operations by MDMS. If the drive is the only one of its kind (for example if it accepts volumes of a particular media type that no other drives accept), make sure you have another drive that can take load requests. Return the drive to operation by setting the enabled attribute.

#### 11.2.1.4 Determining Drive State

---

##### Caution

---

**Changing the value of the state attribute could cause MDMS or the applications using it to fail.**

---

The drive object record state attribute shows the state of managed MDMS drives. MDMS sets one of four values for this attribute: Empty, Full, Loading, or Unloading.

#### 11.2.1.5 Adding and Removing Managed Drives

The procedure described in [describes how to add a drive to the MDMS domain.](#)

The procedure described in [describes how to remove a drive from the MDMS domain.](#)

## MDMS Configuration

### 11.2 Configuring MDMS Drives, Jukeboxes and Locations

#### 11.2.1.6 Configuring MDMS Jukeboxes

MDMS manages Media Robot Driver (MRD) controlled jukeboxes and DCSC controlled jukeboxes. MRD is a software that controls SCSI-2 compliant medium changers. DCSC is software that controls large jukeboxes manufactured by StorageTek, Inc. This section first describes the MDMS attributes used for describing all jukeboxes by function. Subsequent descriptions explain attributes that characterize MRD jukeboxes and DCSC jukeboxes respectively.

#### 11.2.1.7 How to Describe an MDMS Jukebox

Assign unique names to jukeboxes you manage in the MDMS domain. When you create the jukebox object record, supply a name that describes the jukebox.

Set the control attribute to MRD if the jukebox operates under MRD control. Otherwise, set the control to DCSC.

Use the description attribute to store a free text description of the drive. You can describe its role in the data center operation or other useful information. MDMS stores this information for you, but takes no actions with it.

#### 11.2.1.8 How to Control Access to an MDMS Jukebox

You can dedicate a jukebox solely to MDMS operations, or you can allow other applications and users access to the jukebox device. Specify your preference with the shared attribute.

You need to decide which systems in the data center are going to access the jukebox.

Use the groups attribute if you created group object records to represent nodes in an OpenVMS Cluster environment or nodes that share a common device.

Use the nodes attribute if you have no reason to refer to any collection of nodes as a single entity, and you plan to manage nodes, and the objects that refer to them, individually.

#### 11.2.1.9 How to Configure an MDMS Jukebox for Operations.

Disable the jukebox to exclude it from operations. Make sure that applications using MDMS will either use other managed jukeboxes, or make no request of a jukebox you disable. Enable the jukebox after you complete any configuration changes. Drives within a disabled jukebox cannot be allocated.

#### 11.2.1.10 Attribute for DCSC Jukeboxes

Set the library attribute to the library identifier of the particular silo the jukebox objects represents. MDMS supplies 1 as the default value. You will have to set this value according the number silos in the configuration and the sequence in which they are configured.

#### 11.2.1.11 Attributes for MRD Jukeboxes

Specify the number of slots for the jukebox. Alternatively, if the jukebox supports magazines, specify the topology for the jukebox (see Section 11.2.1.13).

The robot attribute must contain the OpenVMS device name of the jukebox medium changer (also known as the robotic device).

If the jukebox is accessed from nodes other than the one from which the command was entered, you must specify nodes or groups in the /NODE or /GROUP attributes in the jukebox record. Do not specify nodes or groups in the jukebox name or the robot attribute.

### 11.2.1.12 Determining Jukebox State

**Caution**

**Changing the value of the state attribute could cause MDMS or the applications using it to fail.**

The jukebox object record state attribute shows the state of managed MDMS jukeboxes. MDMS sets one of three values for this attribute: Available, In use, and Unavailable.

### 11.2.1.13 Magazines and Jukebox Topology

If you decide that your operations benefit from the management of magazines (groups of volumes moved through your operation with a single name) must set the jukebox object record to enable it. Set the usage attribute to magazine and define the jukebox topology with the topology attribute. See Figure 11–4 for a sample overview of how the 11 and 7 slot bin packs can be used as a magazine.

Setting the usage attribute to nomagazine means that you will move volumes into and out of the jukebox independently (using separate commands for each volume, regardless if they are placed into a physical magazine or not).

**Figure 11–3 Jukebox Topology**

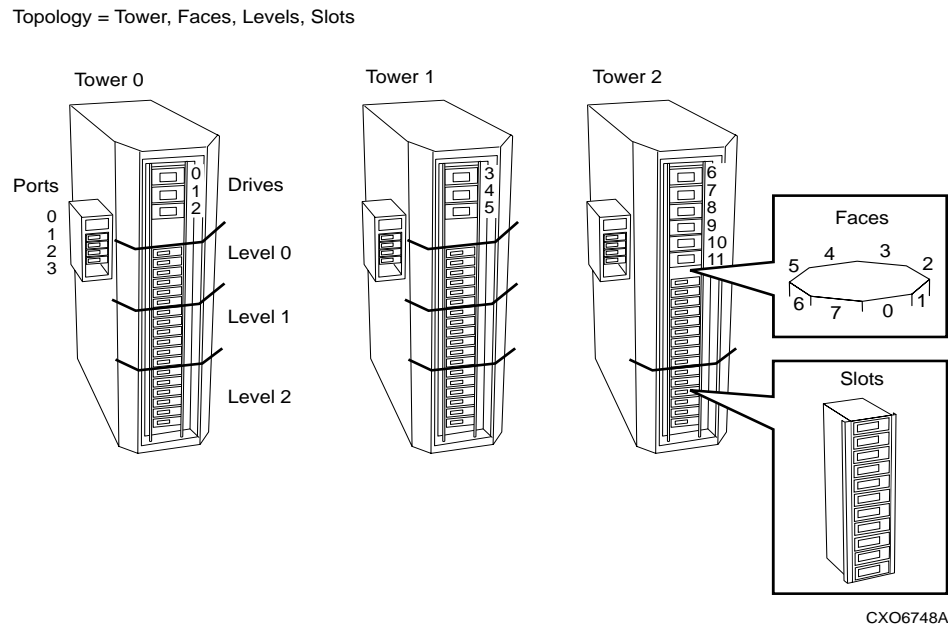

The following paragraphs explain jukebox topology.

#### Towers, Faces, Levels, and Slots

Some jukeboxes have their slot range subdivided into towers, faces, and levels. See Figure 11–3 for an overview of how the configuration of Towers, Faces, Levels and Slots constitute Topology. Note that the topology in Figure 11–3 comprises 3 towers. In the list of topology characteristics, you should identify every tower in the configuration. For each tower in the configuration, you must return identify:

- the tower by number (starting at zero)

## MDMS Configuration

### 11.2 Configuring MDMS Drives, Jukeboxes and Locations

- the number of faces in the tower (starting at one)
- the number of levels per face (starting at one)
- the number of slots per magazine (starting at one)

#### Restrictions for Using Magazines

You must manually open the jukebox when moving magazines into and out of the jukebox. Once in the jukebox, volumes can only be loaded and unloaded relative to the slot in the magazine it occupies.

#### TL896 Example

While using multiple TL896 jukebox towers you can treat the 11 slot bin packs as magazines. The following command configures the topology of the TL896 jukebox as shown in Figure 11–4 for use with magazines:

```
$ MDMS CREATE JUKEBOX JUKE_1/ -  
$_ /TOPOLOGY=(TOWERS=(0,1,2), FACES=(8,8,8), -  
$_ LEVELS=(3,3,2), SLOTS=(11,11,11))
```

Figure 11–4 Magazines

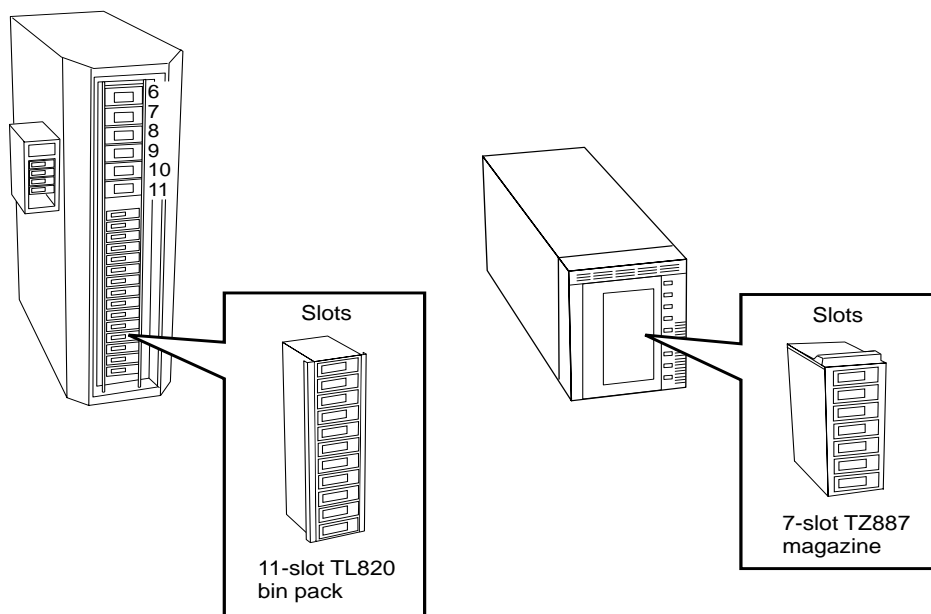

CXO6749A

### 11.2.2 Summary of Drive and Jukebox Issues

This section describes some of the management issues that involve both drives and jukeboxes.

#### 11.2.2.1 Enabling MDMS to Automatically Respond to Drive and Jukebox Requests

Drive and jukebox object records both use the automatic load reply attribute to provide an additional level of automation.

When you set the automatic reply attribute to the affirmative, MDMS will poll the drive or jukebox for successful completion of an operator-assisted operation for those operations where polling is possible. For example, MDMS can poll a drive, determine that a volume is in the drive, and cancel the associated OPCOM request to acknowledge a load. Under these circumstances, an operator need not reply to the OPCOM message after completing the load.

## MDMS Configuration

### 11.2 Configuring MDMS Drives, Jukeboxes and Locations

To use this feature, set the automatic reply attribute to the affirmative. When this attribute is set to the negative, which is the default, an operator must acknowledge each OPCOM request for the drive or jukebox before the request is completed.

#### 11.2.2.2 Creating a Remote Drive and Jukebox Connection

If you need to make backup copies to a drive in a remote location, using the network, then you must install the Remote Device Facility software (RDF). The RDF software must then be configured to work with MDMS.

See Table 11–9 for a description of the actions you need to take to configure RDF software.

**Table 11–9 Actions for Configuring Remote Drives**

Stage	Action
1.	Install the appropriate RDF component on the node. <ul style="list-style-type: none"><li>• Install the RDF Server software on all nodes that are connected to the tape drives used for remote operations.</li><li>• Install the RDF Client software on all nodes that initiate remote operations to those tape drives.</li></ul>
2.	For each tape drive served with RDF Server software, make sure there is a drive object record in the MDMS that describes it.  Take note of each node connected to the drive, even if the drive object record includes a group definition instead of a node.
3.	On each node connected to the tape drive, edit the file <code>TTI_RDEV:CONFIG_node.DAT</code> so that all tape drives are represented. The syntax for representing tape drives is given in the file.

#### 11.2.2.3 How to Add a Drive to a Managed Jukebox

When you add another drive to a managed jukebox, just specify the name of the jukebox in which the drive resides, in the drive object record.

#### 11.2.2.4 Temporarily Taking a Managed Device From Service

You can temporarily remove a drive or jukebox from service. MDMS allows you to disable and enable drive and jukebox devices. This feature supports maintenance or other operations where you want to maintain MDMS support for ABS or HSM, and temporarily remove a drive or jukebox from service.

---

#### Note

---

**If you remove a jukebox from service, you cannot access any of its volumes. Make sure you empty the jukebox, or make sure your operations will continue, without the use of the volumes in any jukebox you disable.**

---

#### 11.2.2.5 Changing the Names of Managed Devices

During the course of management, you might encounter a requirement to change the device names of drives or jukeboxes under MDMS management, to avoid confusion in naming. When you have to change the device names, follow the procedure in Table 11–10.

# MDMS Configuration

## 11.2 Configuring MDMS Drives, Jukeboxes and Locations

**Table 11–10 Changing the Names of Managed Devices**

Step...	Action...
1.	Either find a time when ABS or HSM is not using the drive or jukebox device or disable the device with MDMS.
2.	Change the device names at the operating system. Verify the devices respond using operating system commands or MRU commands for a jukebox device.
3.	Change the MDMS drive device name, and/or the jukebox robot name as needed to reflect the new system device names.
4.	If your drive and/or jukebox object records are named according to the operating system device name, then you should create new object records. If you want to create new object records, use the inherit feature and specify the previous object record. For GUI operation.
5.	If you created new object records, then delete the old object records, and check and modify any references to the old object records. For more information.
6.	Enable the new drive and/or jukebox with MDMS.

### 11.2.3 Locations for Volume Storage

MDMS allows you to identify locations in which you store volumes. Create a location object record for each place the operations staff uses to store volumes. These locations are referenced during move operations, load to, or unload from stand-alone drives.

**Figure 11–5 Volume Locations**

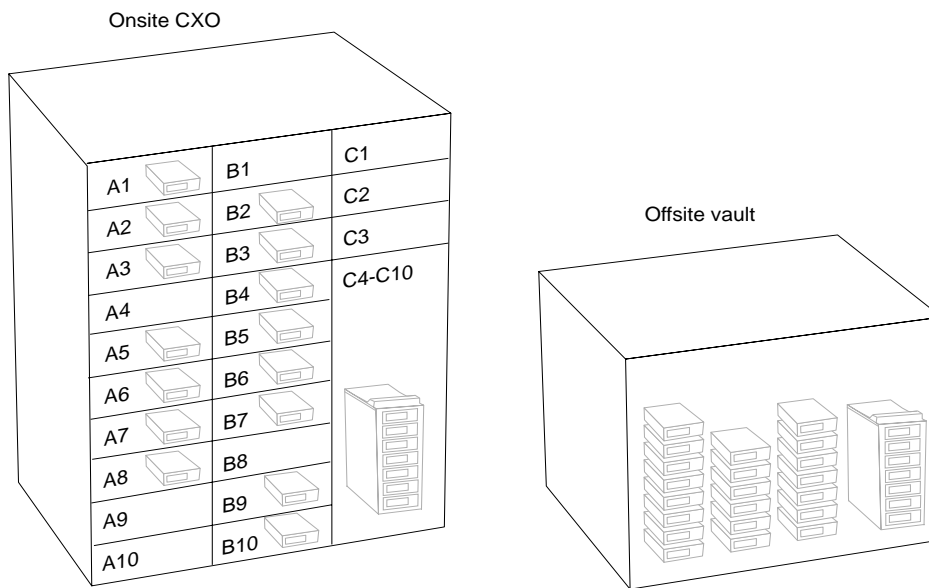

CXO6750A



## MDMS Configuration

### 11.3 Sample MDMS Configurations

If you need to divide your location space into smaller, named locations, define locations hierarchically. The location attribute of the location object record allows you to name a higher level location. For example, you can create location object records to describe separate rooms in a data center by first creating a location object record for the data center. After that, create object records for each room, specifying the data center name as the value of the location attribute for the room locations.

When allocating volumes or drives by location, the volumes and drives do not have to be in the exact location specified; rather they should be in a compatible location. A location is considered compatible with another if both have a common root higher in the location hierarchy. For example, in Figure 11–6, locations Room\_304 and Floor\_2 are considered compatible, as they both have location Building\_1 as a common root.

**Figure 11–6 Named Locations**

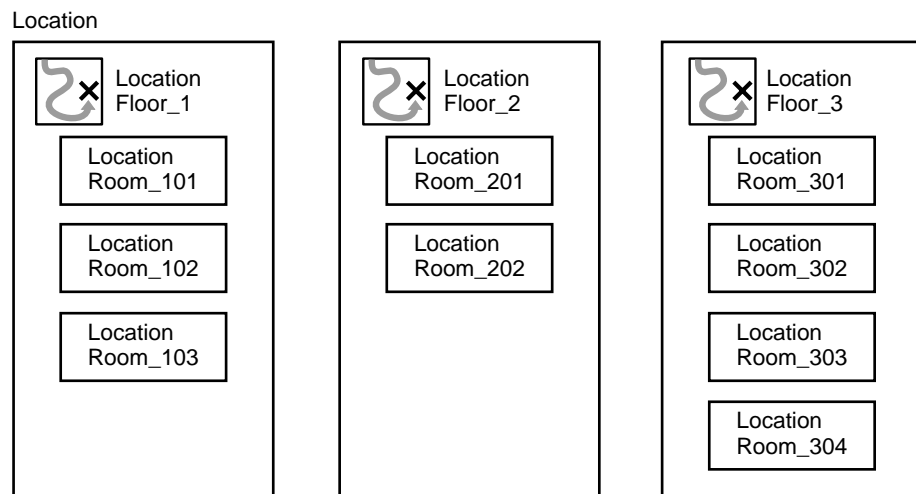

CXO6751A

Your operations staff must be informed about the names of these locations as they will appear in OPCOM messages. Use the description attribute of the location object record to describe the location it represents as accurately as possible. Your operations staff can refer to the information in the event they become confused about a location mentioned in an OPCOM message.

You can divide a location into separate spaces to identify locations of specific volumes. Use the spaces attribute to specify the range of spaces in which volumes can be stored. If you do not need that level of detail in the placement of volumes at the location, negate the attribute.

## 11.3 Sample MDMS Configurations

The Appendix - Sample Configuration of MDMS, contains a set of sample MDMS V4 configurations. These samples will help you make necessary checks for completeness.



## MDMS Management Operations

### 12.1 Managing Volumes

MDMS manages volume availability with the concept of a life cycle. The primary purpose of the life cycle is to ensure that volumes are only written when appropriate, and by authorized users. By setting a variety of attributes across multiple objects, you control how long a volume, once written, remains safe. You also set the time and interval for a volume to stay at an offsite location for safe keeping, then return for re-use once the interval passes.

This section describes the volume life cycle, relating object attributes, commands and life cycle states. This section also describes how to match volumes with drives by creating media type object records.

#### 12.1.1 Volume Life Cycle

The volume life cycle determines when volumes can be written, and controls how long they remain safe from being overwritten. Table 12–1 describes operations on volumes within the life cycle.

**Figure 12–1 Volume States**

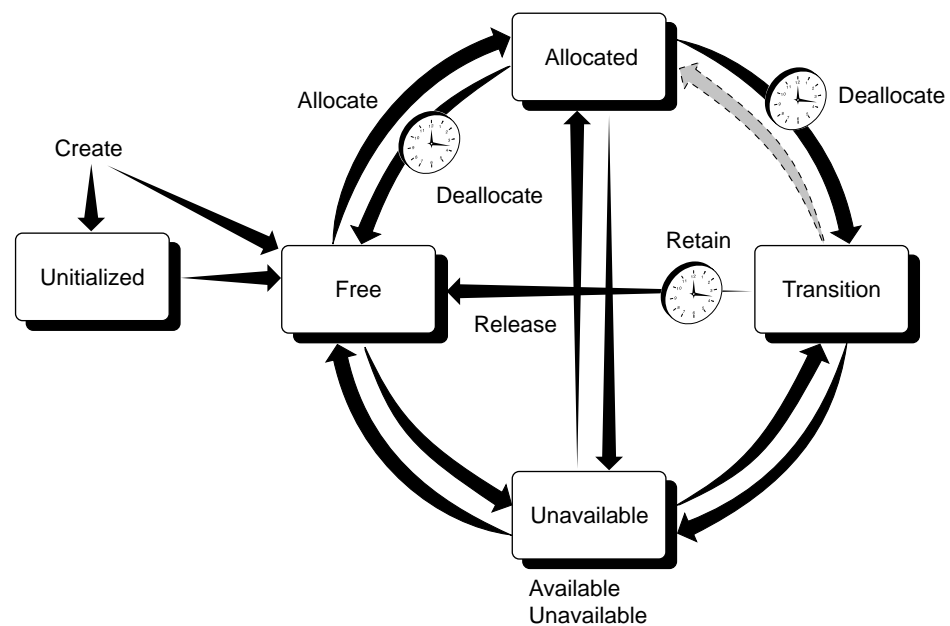

CXO6756A

## MDMS Management Operations

### 12.1 Managing Volumes

Each row describes an operation with current and new volume states, commands and GUI actions that cause volumes to change states, and if applicable, the volume attributes that MDMS uses to cause volumes to change states. Descriptions following the table explain important aspects of each operation.

**Table 12–1 MDMS Volume State Transitions**

Current State	Transition to New State	New State
Blank	MDMS CREATE VOLUME Volume Create	UNINITIALIZED
Blank	MDMS CREATE VOLUME/PREINIT	FREE
UNINITIALIZED	MDMS INITIALIZE VOLUME Volume Initialize	FREE
FREE	MDMS INITIALIZE VOLUME Volume Initialize	FREE
FREE	MDMS ALLOCATE VOLUME Volume Allocate	ALLOCATED
ALLOCATED	MDMS DEALLOCATE VOLUME Volume Deallocate or automatically on the volume scratch date	TRANSITION
ALLOCATED	MDMS DEALLOCATE VOLUME Volume Deallocate or automatically on the volume scratch date	FREE
TRANSITION	MDMS SET VOLUME /RELEASE Volume Release or automatically on the volume transition time	FREE
Any State	MDMS SET VOLUME /UNAVAILABLE Volume Unavailable	UNINITIALIZED
UNINITIALIZED	MDMS SET VOLUME /AVAILABLE Volume Available	Previous State
UNINITIALIZED	MDMS DELETE VOLUME Volume Delete	BLANK
FREE	MDMS DELETE VOLUME Volume Delete	BLANK

#### 12.1.2 Volume States by Manual and Automatic Operations

This section describes the transitions between volume states. These processes enable you to secure volumes from unauthorized use by MDMS client applications, or make them available to meet continuing needs. Additionally, in some circumstances, you might have to manually force a volume transition to meet an operational need.

*Understanding how these volume transitions occur automatically under MDMS control, or take place manually will help you manage your volumes effectively.*

### 12.1.2.1 Creating Volume Object Records

You have more than one option for creating volume object records. You can create them explicitly with the MDMS CREATE VOLUME command: individually, or for a range of volume identifiers.

You can create the volumes implicitly as the result of an inventory operation on a jukebox. If an inventory operation finds a volume that is not currently managed, a possible response (as you determine) is to create a volume object record to represent it.

You can also create volume object records for large numbers of volumes by opening the jukebox, loading the volumes into the jukebox slots, then running an inventory operation.

Finally, it is possible to perform scratch loads on standalone or stacker drives using the MDMS LOAD DRIVE /CREATE command. If the volume that is loaded does not exist in the database, MDMS will create it.

You must create volumes explicitly through the MDMS CREATE VOLUME command, or implicitly through the inventory or load operations.

### 12.1.2.2 Initializing a Volume

---

**Caution**

---

**MDMS expects the internally initialized volume label on the physical medium will match the printed label. Always initialize volumes so the recorded volume labels match the printed labels. If the recorded volume label on the tape does not match the printed label on the cartridge, MDMS operations will fail.**

---

Use the MDMS initialize feature to make sure that MDMS recognizes volumes as initialized. Unless you acquire preinitialized volumes, you must explicitly initialize them MDMS before you can use them. If your operations require, you can initialize volumes that have just been released from allocation.

When you initialize a volume or create a volume object record for a preinitialized volume, MDMS records the date in the initialized date attribute of the volume object record.

### 12.1.2.3 Allocating a Volume

Typically, applications request the allocation of volumes. Only in rare circumstances will you have to allocate a volume to a user other than ABS or HSM. However, if you use command procedures for customized operations that require the use of managed media, you should be familiar with the options for volume allocation. Refer to the ABS or HSM Command Reference Guide for more information on the MDMS ALLOCATE command.

Once an application allocates a volume, MDMS allows read and write access to that volume only by that application. MDMS sets volume object record attributes to control transitions between volume states. Those attributes include:

- the allocated date attribute contains the date and time MDMS allocates the volume.
- the scratch date attribute contains the date and time MDMS will deallocate the volume.

The application requesting the volume can direct MDMS to set additional attributes for controlling how long it keeps the volume and how it releases it. These attributes include:

- the scratch date attributes indicates the date when MDMS automatically sets the volume to a non-allocated state. A volume reaching the scratch date may be either free for use, or may be placed in a transition state.

## MDMS Management Operations

### 12.1 Managing Volumes

- the transition time attribute contains the time interval a volume remains in the transition state. The transition state allows you to buffer, or stage, the release of volumes between their allocation (for keeping data safe) and their subsequent re-use (overwriting data). To release volumes directly to a free state, negate the attribute.

#### 12.1.2.4 Holding a Volume

MDMS allows no other user or application to load or unload a volume with the state attribute value set to ALLOCATED, unless the user has MDMS\_LOAD\_ALL rights. This volume state allows you to protect your data. Set the amount of time a volume remains allocated according to your data retention requirements.

During this time, you can choose to move the volume to an offsite location.

#### 12.1.2.5 Freeing a Volume

When a volume's scratch date passes, MDMS automatically frees the volume from allocation.

If the application or user negates the volume object record scratch date attribute, the volume remains allocated permanently.

*Use this feature when you need to retain the data on the volume indefinitely.*

After the data retention time has passed, you have the option of making the volume immediately available, or you can elect to hold the volume in a TRANSITION state. To force a volume through the TRANSITION state, negate the volume object record transition time attribute.

You can release a volume from transition with the DCL command MDMS SET VOLUME /RELEASE. Conversely, you can re-allocate a volume from either the FREE or TRANSITION states with the DCL command MDMS SET VOLUME /RETAIN.

Once MDMS sets a volume's state to FREE, it can be allocated for use by an application once again.

#### 12.1.2.6 Making a Volume Unavailable

You can make a volume unavailable if you need to prevent ongoing processing of the volume by MDMS. MDMS retains the state from which you set the UNAVAILABLE state. When you decide to return the volume for processing, the volume state attribute returns to its previous value.

The ability to make a volume unavailable is a manual feature of MDMS.

### 12.1.3 Matching Volumes with Drives

MDMS matches volumes with drives capable of loading them by providing the logical media type object. The media type object record includes attributes whose values describe the attributes of a type of volume.

The domain object record names the default media types that any volume object record will take if none is specified.

Create a media type object record to describe each type of volume. Drive object records include an attribute list of media types the drive can load, read, and write.

Volume object records for uninitialized volumes include a list of candidate media types. Volume object records for initialized volumes include a single attribute value that names a media type. To allocate a drive for a volume, the volume's media type must be listed in the drive object record's media type field, or its read-only media-type field for read-only operations.

### 12.1.4 Magazines for Volumes

Use magazines when your operations allow you to move and manage groups of volumes for single users. Create a magazine object record, then move volumes into the magazine (or similar carrier) with MDMS. All the volumes can now be moved between locations and jukeboxes by moving the magazine to which they belong.

Figure 12–2 Magazines

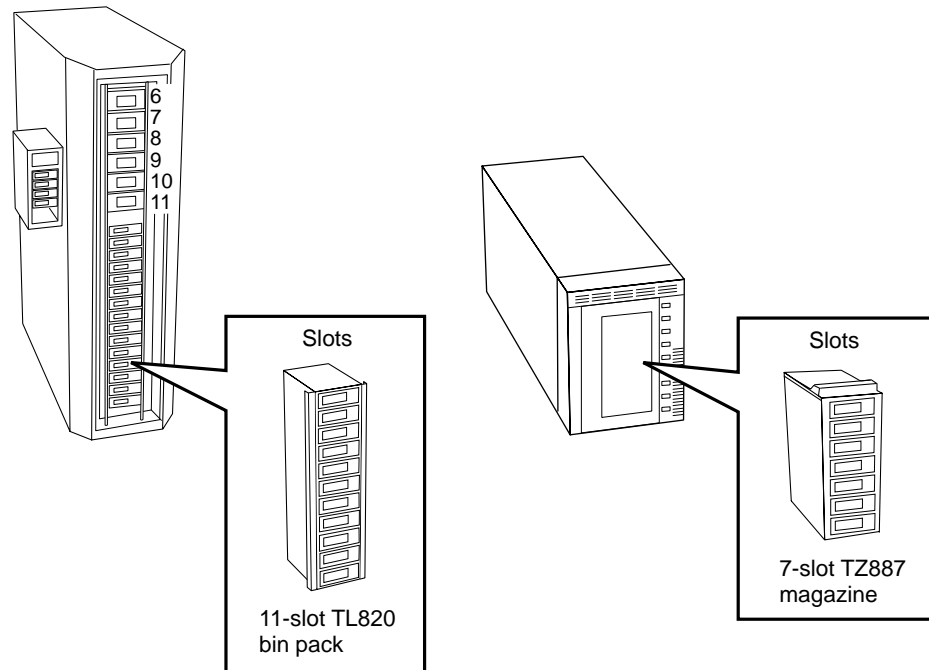

CXO6749A

The jukeboxes must support the use of magazines; that is, they must use carriers that can hold multiple volumes at once. If you choose to manage the physical movement of volumes with magazines, then you may set the usage attribute to `MAGAZINE` for jukebox object records of jukeboxes that use them. You may also define the topology attribute for any jukebox used for magazine based operations.

If your jukebox does not have ports, and requires you to use physical magazines, you do not have to use the MDMS magazine object record. The jukebox can still access volumes by slot number. Single volume operations can still be conducted by using the move operation on individual volumes, or on a range of volumes.

### 12.1.5 Symbols for Volume Attributes

MDMS provides a feature that allows you to define a series of OpenVMS DCL symbols that describe the attributes of a given volume. By using the `/SYMBOLS` qualifier with the `MDMS SHOW VOLUME` command, you can define symbols for all the volume object record attribute values. Use this feature interactively, or in DCL command procedures, when you need to gather information about volumes for subsequent processing.

Refer to the ABS or HSM Command Reference Guide description of the `MDMS SHOW VOLUME` command.

## MDMS Management Operations

### 12.2 Managing Operations

## 12.2 Managing Operations

MDMS manages volumes and devices as autonomously as possible. However, it is sometimes necessary - and perhaps required - that your operations staff be involved with moving volumes or loading volumes in drives. When MDMS cannot conduct an automatic operation, it sends a message through the OpenVMS OPCOM system to an operator terminal to request assistance.

*Understanding this information will help you set up effective and efficient operations with MDMS.*

### 12.2.1 Setting Up Operator Communication

This section describes how to set up operator communication between MDMS and the OpenVMS OPCOM facility. Follow the steps in Table 12–2 to set up operator communication.

**Table 12–2 Setting Up Operator Communication**

Step...	Action...
1.	Check or set OPCOM classes for each MDMS node.
2.	Identify the operator terminals nearest to MDMS locations, drives, and jukeboxes.
3.	Enable the operator terminals to receive communication through the OPCOM classes set.

#### 12.2.1.1 Set OPCOM Classes by Node

Set the domain object record OPCOM attribute with the default OPCOM classes for any node in the MDMS management domain.

Each MDMS node has a corresponding node object record. An attribute of the node object record is a list of OPCOM classes through which operator communication takes place. Choose one or more OPCOM classes for operator communication to support operations with this node.

#### 12.2.1.2 Identify Operator Terminals

Identify the operator terminals closest to MDMS locations, drives and jukeboxes. In that way, you can direct the operational communication between the nodes and terminals whose operators can respond to it.

#### 12.2.1.3 Enable Terminals for Communication

Make sure that the terminals are configured to receive OPCOM messages from those classes. Use the OpenVMS REPLY/ENABLE command to set the OPCOM class that corresponds to those set for the node or domain.

```
$REPLY/ENABLE=(opcom_class, [...])
```

Where *opcom\_class* specifications are those chosen for MDMS communication.



## 12.2.2 Activities Requiring Operator Support

Several commands include an assist feature where you can either require or forego operator involvement. Other MDMS features allow you to communicate with particular OPCOM classes, making sure that specific operators get messages. You can configure jukebox drives for automatic loading, and stand alone drives for operator supported loading. See Table 12–3 for a list of operator communication features and your options for using them.

**Table 12–3 Operator Management Features**

Use These Features...	To Manage These Operations...
Domain and node object records, OPCOM classes attribute	Use this attribute of the node and domain object records to identify the operator terminals to receive OPCOM messages. The domain OPCOM classes apply if none are specified for any node.
Drive and jukebox object records, automatic reply attribute	Use this attribute to control whether operator acknowledgments are required for certain drive and jukebox operations. The default (negated) value requires operator acknowledgment for all operations. Setting the attribute to the affirmative will result in MDMS polling the devices for most operations, and completing the request without specific operator acknowledgment. The operator should observe the OPCOM message and look for one of two phrases: <ul style="list-style-type: none"> <li>• "and reply when completed" - this means that the OPCOM message must be acknowledged before the request will continue</li> <li>• "(auto-reply enabled)" - this means that the OPCOM message will be automatically cancelled and the request will continue after the requested action has been performed</li> </ul>
Assist or noassist options and the reply option for these commands or actions: <ul style="list-style-type: none"> <li>– Allocate drive</li> <li>– Initialize volume</li> <li>– Load drive</li> <li>– Load volume</li> <li>– Move magazine</li> <li>– Move volume</li> <li>– Unload drive</li> <li>– Unload volume</li> </ul>	For all listed commands, you can either request or forego operator assistance. When you use the assist option, MDMS will communicate with the operators specified by the OPCOM classes set in the domain object record. Using the noassist option directs MDMS not to send operator messages. You must be granted the MDMS_ASSIST right to use the assist option. The reply option allows you to capture the operator reply to the command. This feature facilitates the use of DCL command procedures to manage interaction with operators.
The message option for these commands: <ul style="list-style-type: none"> <li>– Load drive</li> <li>– Load volume</li> </ul>	For load operations, use the message option to pass additional information to the operator identified to respond to the load request.

## 12.3 Serving Clients of Managed Media

Once configured, MDMS serves ABS and HSM with uninterrupted access to devices and volumes for writing data. Once allocated, MDMS catalogs volumes to keep them safe, and makes them available when needed to restore data.

To service ABS and HSM, you must supply volumes for MDMS to make available, enable MDMS to manage the allocation of devices and volumes, and meet client needs for volume retention and rotation.

### 12.3.1 Maintaining a Supply of Volumes

To create and maintain a supply of volumes, you must regularly add volumes to MDMS management, and set volume object record attributes to allow MDMS to meet ABS and HSM needs.

#### 12.3.1.1 Preparing Managed Volumes

To prepare volumes for use by MDMS, you must create volume object records for them and initialize them if needed. MDMS provides different mechanisms for creating volume object records: the create, load, and inventory operations. When you create volume object records, you should consider these factors:

- The situational demands under which you create the volume object records.
- The application needs of the volumes for which you create object records.
- Those additional aspects of the volume for which you will have little, if any, need to change later on.

The following sections provide more detailed information.

#### Meeting Situational Demands

If you create volume object records with the use of a vision equipped jukebox, you must command MDMS to use the jukebox vision system and identify the slots in which the new volumes reside. These two operational parameters must be supplied to either the create or inventory operation.

For command driven operations, these two commands are functionally equivalent.

```
$MDMS INVENTORY JUKEBOX jukebox_name /VISION/SLOTS=slot_range /CREATE  
$MDMS CREATE VOLUME /JUKEBOX=jukebox_name /VISION/SLOTS=slot_range
```

If you create volume object records with the use of a jukebox that does not have a vision system, **you must supply the range of volume names as they are labelled and as they occupy the slot range.**

If you create volume object records for volumes that reside in a location other than the default location (as defined in the domain object record), you must identify the placement of the volumes and the location in the onsite or offsite attribute. Additionally, you must specify the volume name or range of volume names.

If you create volume object records for volumes that reside in the default onsite location, you need not specify the placement or onsite location. However, you must specify the volume name or range of volume names.

### Meeting Application Needs

If you acquire preinitialized volumes for MDMS management, and you want to bypass the MDMS initialization feature, you must specify a single media type attribute value for the volume.

Select the format to meet the needs of your MDMS client application. For HSM, use the BACKUP format. For ABS, use BACKUP or RMUBACKUP.

Use a record length that best satisfies your performance requirements. Set the volume protection using standard OpenVMS file protection syntax. Assign the volume to a pool you might use to manage the consumption of volumes between multiple users.

### Static Volume Attributes

Static volume attributes rarely, if ever, need to be changed. MDMS provides them to store information that you can use to better manage your volumes.

The description attribute stores up to 255 characters for you to describe the volume, its use, history, or any other information you need.

The brand attribute identifies the volume manufacturer.

Use the record length attribute to store the length or records written to the volume, when that information is needed.

## 12.3.2 Servicing a Stand Alone Drive

If you use a stand alone drive, enable MDMS operator communication on a terminal near the operator who services the drive. MDMS signals the operator to load and unload the drive as needed.

You must have a ready supply of volumes to satisfy load requests. If your application requires specific volumes, they must be available, and the operator must load the specific volumes requested.

To enable an operator to service a stand alone drive during MDMS operation, perform the actions listed in Table 12–4.

**Table 12–4 Configuring MDMS to Service a Stand Alone Drive**

Stage...	Action...
1.	Enable operator communication between nodes and terminals.
2.	Stock the location where the drive resides with free volumes.
3.	For all subsequent MDMS actions involving the drive, use the assist feature.

## 12.3.3 Servicing Jukeboxes

MDMS incorporates many features that take advantage of the mechanical features of automated tape libraries and other medium changers. Use these features to support lights-out operation, and effectively manage the use of volumes.

Jukeboxes that use built-in vision systems to scan volume labels provide the greatest advantage. If the jukebox does not have a vision system, MDMS has to get volume names by other means. For some operations, the operator provides volume names individually or by range. For other operations, MDMS mounts the volume and reads the recorded label.

## MDMS Management Operations

### 12.3 Serving Clients of Managed Media

#### 12.3.3.1 Inventory Operations

The inventory operation registers the contents of a jukebox correctly in the MDMS database. You can use this operation to update the contents of a jukebox whenever you know, or have reason to suspect the contents of a jukebox have changed without MDMS involvement.

---

#### Note

**Changing the contents of a jukebox without using MDMS move or inventory features, and not updating the MDMS database, will cause subsequent operations to fail. Always use the MDMS INVENTORY operation to make sure the MDMS database accurately reflects the contents of the jukebox whenever you know, or have reason to suspect the contents of a jukebox has changed.**

---

#### Inventory for Update

When you need to update the database in response to unknown changes in the contents of the jukebox, use the inventory operation against the entire jukebox. If you know the range of slots subject to change, then constrain the inventory operation to just those slots.

If you inventory a jukebox that does not have a vision system, MDMS loads and mounts each volume, to read the volume's recorded label.

---

#### Note

**Running an inventory on a large number of slots without a vision system can take from tens of minutes to several hours.**

---

When you inventory a subset of slots in the jukebox, use the option to ignore missing volumes.

If you need to manually adjust the MDMS database to reflect the contents of jukebox, use the nophysical option for the MDMS move operation. This allows you to perform a logical move for to update the MDMS database.

#### Inventory to Create Volume Object Records

If you manage a jukebox, you can use the inventory operation to add volumes to MDMS management. The inventory operation includes the create, preinitialized, media types, and inherit qualifiers to support such operations.

Take the steps in Table 12–5 to use a vision jukebox to create volume object records.

**Table 12–5 How to Create Volume Object Records with INVENTORY**

Step...	Action...
1.	If you plan to open the jukebox for this operation, disable the jukebox and all drives inside it.
2.	Empty as many slots as necessary to accommodate the volumes.  If you cannot open the jukebox, use the MDMS MOVE command to keep the MDMS database synchronized with the actual location of volumes removed.  If you open the jukebox and manually remove managed volumes, place the volumes in the location specified by the volumes' onsite location.
3.	Place labelled volumes in the open jukebox slots.  If you cannot open the jukebox to expose the slots, use the Media Robot Utility software or front panel controls to move volumes to the slots.

**Table 12–5 How to Create Volume Object Records with INVENTORY**

Step...	Action...
4.	<p>Perform the MDMS inventory operation.</p> <p>Use the create option to signal MDMS to create volume object records.</p> <p>If volumes are initialized specify the preinitialized option and a single media type name for the media types attribute, otherwise, just specify all possible media types to which the volume could relate.</p> <p>Use the inherit option to identify a volume object record from which to inherit other volume attribute values.</p> <p>Use the slots option to specify the range of slots occupied by the volumes to be managed.</p> <p>If the jukebox does not have a vision system, use the volume range and novision options.</p>

### 12.3.4 Managing Volume Pools

To assist with accounting for volume use by data center clients, MDMS provides features that allow you to divide the volumes you manage by creating volume pools and assigning volumes to them.

**Figure 12–3 Pools and Volumes**

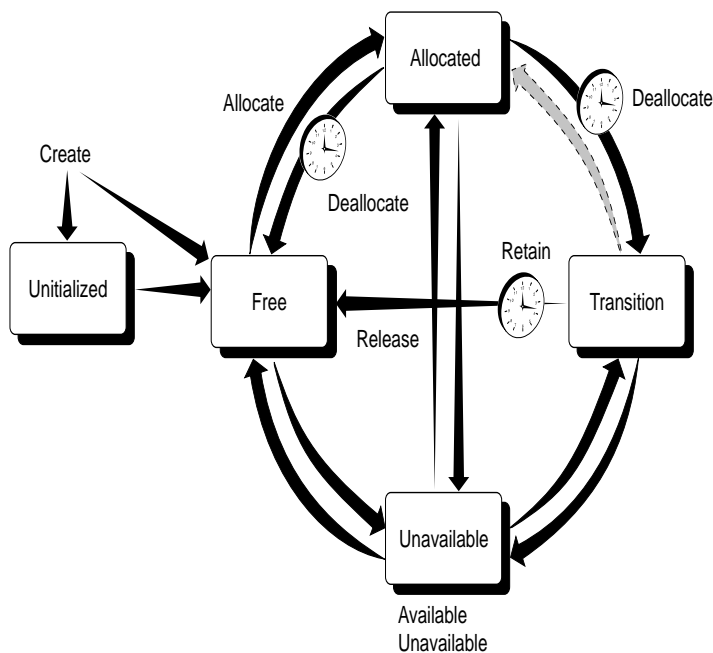

CX06756A

Use MDMS to specify volume pools. Set the volume pool options in ABS or HSM to specify that volumes be allocated from those pools for users as needed. Figure 12–3 identifies the pools respective to a designated group of users. Note that ‘No Pool’ is for use by all users.

## MDMS Management Operations

### 12.3 Serving Clients of Managed Media

#### 12.3.4.1 Volume Pool Authorization

The pool object record includes two attributes to assign pools to users: authorized users, and default users.

Set the authorized users list to include all users, by node or group name, who are allowed to allocate volumes from the pool.

Set the default users list to include all users, by node or group name, for whom the pool will be the default pool. Unless another pool is specified during allocation, volumes will be allocated from the default pool for users in the default users list.

Because volume pools are characterized in part by node or group names, anytime you add or remove nodes or groups, you must review and adjust the volume pool attributes as necessary.

#### 12.3.4.2 Adding Volumes to a Volume Pool

After you create a volume pool object record, you can associate managed volumes with it. Select the range of volumes you want to associate with the pool and set the pool attribute of the volumes to the name of the pool.

This can be done during creation or at any time the volume is under MDMS management.

#### 12.3.4.3 Removing Volumes from a Volume Pool

There are three ways to remove volumes from a volume pool.

- You can delete the volume object records.
- You can set the pool attribute of selected volume object records to a different volume pool name.
- You can negate the pool attribute of selected volume object records.

#### 12.3.4.4 Changing User Access to a Volume Pool

To change access to volume pools, modify the membership of the authorized users list attribute.

If you are using the command line to change user access to volume pools, use the /ADD and /REMOVE command qualifiers to modify the current list contents. Use the /NOAUTHORIZED\_USERS qualifier to erase the entire user list for the volume pool.

If you are using the GUI to change user access to volume pools, just edit the contents of the authorized users field.

You can also authorize users with the /DEFAULT\_USERS attribute, which means that the users are authorized, and that this pool is the pool for which allocation requests for volumes are applied if no pool is specified in the allocation request. You should ensure that any particular user has a default users entry in only one pool.

#### 12.3.4.5 Deleting Volume Pools

You can delete volume pools. However, deleting a volume pool may require some additional clean up to maintain the MDMS database integrity. Some volume records could still have a pool attribute that names the pool to be deleted, and some DCL command procedures could still reference the pool.

If volume records naming the pool exist after deleting the pool object record, find them and change the value of the pool attribute.

The MDMS CREATE VOLUME and MDMS LOAD DRIVE commands in DCL command procedures can specify the deleted pool. Change references to the delete pool object record, if they exist, to prevent the command procedures from failing.

### 12.3.5 Taking Volumes Out of Service

You might want to remove volumes from management for a variety of reasons:

- You need to retain the information recorded on a volume, and remove any MDMS management access to it.
- The volume cartridge has broken.
- The volume has become unreliable.

#### 12.3.5.1 Temporary Volume Removal

To temporarily remove a volume from management, set the volume state attribute to UNAVAILABLE. Any volume object record with the state set to UNAVAILABLE remains under MDMS management, but is not processed through the life cycle. These volumes will not be set to the TRANSITION or FREE state. However, these volumes can be moved and their location maintained.

#### 12.3.5.2 Permanent Volume Removal

---

**Caution**

---

**Before you remove a volume from the MDMS database, MAKE SURE the volume is not storing information for ABS or HSM. If you remove a volume from MDMS management that is referenced from ABS or HSM, you will not be able to restore the data stored on it.**

---

To permanently remove a volume from management, delete the volume object record describing it.

## 12.4 Rotating Volumes from Site to Site

Volume rotation involves moving volumes to an off-site location for safekeeping with a schedule that meets your needs for data retention and retrieval. After a period of time, you can retrieve volumes for re-use, if you need them. You can rotate volumes individually, or you can rotate groups of volumes that belong to magazines.

### 12.4.1 Required Preparations for Volume Rotation

The first thing you have to do for a volume rotation plan is create location object records for the on-site and off-site locations. Make sure these location object records include a suitable description of the actual locations. You can optionally specify hierarchical locations and/or a range of spaces, if you want to manage volumes by actual space locations.

You can define as many different locations as your management plan requires.

Once you have object records that describe the locations, choose those that will be the domain defaults (defined as attributes of the domain object record). The default locations will be used when you create volumes or magazines and do not specify onsite and/or offsite location names. You can define only one onsite location and one offsite location as the domain default at any one time.

### 12.4.2 Sequence of Volume Rotation Events

Manage the volume rotation schedule with the values of the offsite and onsite attributes of the volumes or magazines you manage. You set these values. In addition to setting these attribute values, you must check the schedule periodically to select and move the volumes or magazines.

## MDMS Management Operations

### 12.4 Rotating Volumes from Site to Site

Table 12–6 shows the sequence of volume rotation events and identifies the commands and GUI actions you issue.

**Table 12–6 Sequence of Volume Rotation Events**

Stage...	Action...
1.	<p>Set the volume object record onsite and offsite attributes.</p> <ul style="list-style-type: none"> <li>Typically, once ABS has allocated a volume you will remove it until it is about to reach the scratch date. Set the onsite location and date based on when it will be freed.</li> </ul> <p>Set the offsite location and date based on when it will be ready to be moved offsite. However, make sure that the volume is not part of an ABS continuation set and still needed for subsequent ABS operation.</p> <ul style="list-style-type: none"> <li>For HSM, identify volumes to go offsite based on the last access date. If a volume has not been accessed for a long period of time, there has been no need to unshelve the files stored on it. Set the offsite date based for any time after the last access.</li> </ul> <p>If multiple archive classes are used, the secondary archive class(es) can be removed off site as soon as a volume is filled.</p> <p>Set the onsite date for any time you might want to archive or delete the files on the volume.</p>
2.	<p>Identify the volumes or magazines to be moved offsite by selecting the offsite schedule option. You can use the MDMS report or show volume features, or the show magazine feature. The following CLI examples illustrate this:</p> <pre>\$MDMS SHOW VOLUME /SCHEDULE=OFFSITE</pre> <pre>\$MDMS SHOW MAGAZINE /SCHEDULE=OFFSITE</pre>
3.	<p>Move the volumes offsite. With the GUI, you can move the volumes selected from the display.</p> <p>With the CLI, (interactive or command procedure) use the MDMS MOVE command with the /SCHEDULE qualifier. For example:</p> <pre>\$MDMS MOVE VOLUME /SCHEDULE=OFFSITE [location_name]</pre> <pre>\$MDMS MOVE MAGAZINE /SCHEDULE=OFFSITE [location_name]</pre> <p>MDMS communicates with operators through OPCOM, providing a list of volume identifiers for the volumes to be gathered and moved.</p>
4.	<p>If you need to retrieve volumes or magazines to service a restore or unshelve request, you must physically move them back to the onsite location.</p> <p>Use the MDMS GUI move feature for the selected volumes or magazines or use the CLI MOVE command. For example:</p> <pre>\$MDMS MOVE VOLUME volume_id location_name</pre> <pre>\$MDMS MOVE MAGAZINE magazine_id location_name</pre>



**Table 12–6 Sequence of Volume Rotation Events**

Stage...	Action...
5.	<p>To return volumes to the onsite location based on their scheduled return date, use the GUI to select and move volumes and magazines based on their onsite schedule. With the GUI, you can move the volumes selected from the display.</p> <p>With the CLI, (interactive or command procedure) use the MDMS MOVE command with the /SCHEDULE qualifier. For example:</p> <pre style="margin-left: 40px;">\$MDMS MOVE VOLUME /SCHEDULE=ONSITE volume_id location_name</pre> <pre style="margin-left: 40px;">\$MDMS MOVE MAGAZINE /SCHEDULE=ONSITE - \$_ magazine_name location_name</pre>
6.	<p>Once the volumes and magazines arrive at the onsite location, negate the offsite and onsite schedules. This prevents the volumes from showing up in subsequent reports. With the GUI, remove the location date values associated with the offsite and onsite attributes.</p> <p>With the CLI, use the /NOONSITE and /NOOFFSITE qualifiers. For example:</p> <pre style="margin-left: 40px;">SET VOLUME volume_id /NOONSITE /NOOFFSITE</pre>

## 12.5 Scheduled Activities

MDMS starts three scheduled activities at 1AM, by default, to do the following:

- Deallocate all volumes in the database that have exceeded their scratch date.
- Release all volumes in the database that have exceeded their transition time.
- Schedule all volumes that have exceeded their onsite or offsite date.
- Schedule all magazines that have exceeded their onsite or offsite date.

These three activities are controlled by a logical, are separate jobs with names, generate log files, and notify users when volumes are deallocated. These things are described in the sections below.

### 12.5.1 Logical Controlling Scheduled Activities

The start time for *scheduled activities* is controlled by the logical:

```
MDMS$SCHEDULED_ACTIVITIES_START_HOUR
```

By default, the scheduled activities start at 1AM which is defined as:

```
$ DEFINE /SYSTEM/NOLOG MDMS$SCHEDULED_ACTIVITIES_START_HOUR 1
```

You can change when the scheduled activities start by changing this logical in SYSS\$STARTUP:MDMS\$SYSTARTUP.COM. The hour must be an integer between 0 and 23.

### 12.5.2 Job Names of Scheduled Activities

When these scheduled activities jobs start up, they have the following names:

- MDMS\$DEALVOL - deallocates and releases volumes
- MDMS\$MOVVOL - moves scheduled volumes
- MDMS\$MOV MAG - moves scheduled magazines

If any volumes are deallocated, the users in the Mail attribute of the Domain object will receive notification by VMS mail.

Operators will receive Opcom requests to move the volumes or magazines.

## MDMS Management Operations

### 12.5 Scheduled Activities

#### 12.5.3 Log Files for Scheduled Activities

These scheduled activities generate log files. These log files are located in MDMS\$LOGFILE\_LOCATION and are named:

- MDMS\$DEALVOL.LOG - for deallocating and releasing volumes
- MDMS\$MOVVOL - for moving of scheduled volumes
- MDMS\$MOV MAG - for moving of scheduled magazines

These log files do not show which volumes or magazines were acted upon. They show the command that was executed and whether it was successful or not.

If the Opcom message is not replied to by the time the next scheduled activities is started, the activity is cancel and a new activity is scheduled. For example, nobody replied to the message from Saturday at 1AM, so on Sunday MDMS canceled the request and generated a new request. The log file for Saturday night would look like this:

```
$ SET VERIFY
$ SET ON
$ MDMS MOVE VOL */SCHEDULE
%MDMS-E-CANCELED, request canceled by user
MDMS$SERVER job terminated at 08-Apr-2002 01:01:30.48
```

Nothing is lost because the database did not change, but this new request could require more volumes or magazines to be moved.

The following shows an example that completed successfully after deallocating and releasing the volumes:

```
$ SET VERIFY
$ SET ON
$ MDMS DEALLOCATE VOLUME /SCHEDULE/VOLSET
MDMS$SERVER job terminated at 08-Apr-2002 01:03:31.66
```

---

#### Note

**The number of these log files could grow to a large number. You may want to set the version on these scheduled activities to 10 or so.**

---

#### 12.5.4 Notify Users When Volumes are Deallocated

To notify users when the volumes are deallocated, place the user names in the Mail attribute of the Domain object. For example:

```
$ MDMS show domain
Description: Smith's Special Domain
Mail: SYSTEM,OPERATOR1,SMITH
Offsite Location: JOHNNY_OFFSITE_TAPE_STORAGE
Onsite Location: OFFICE_65
Def. Media Type: TLZ09M
Deallocate State: TRANSITION
Opcom Class: TAPES
Request ID: 496778
Protection: S:RW,O:RW,G:R,W
DB Server Node: DEBBY
DB Server Date: 08-Apr-2002 14:20:08
Max Scratch Time: NONE
Scratch Time: 365 00:00:00
Transition Time: 1 00:00:00
Network Timeout: NONE
$
```

## MDMS Management Operations 12.5 Scheduled Activities

In the above example, users SYSTEM, OPERATOR1, and SMITH will receive VMS mail when any volumes are deallocated during scheduled activities or when some one issues the following command:

```
§ MDMS DEALLOCATE VOLUME /SCHEDULE/VOLSET
```

If you delete all users in the Mail attribute, nobody will receive mail when volumes are deallocated by the scheduled activities or the DEALLOCATE VOLUME /SCHEDULE command.



---

## MDMS High Level Tasks

MDMS GUI users have access to features that guide them through complex tasks. These features conduct a dialog with users, asking them about their particular configuration and needs, and then provide the appropriate object screens with information about setting specific attribute values.

The features support tasks that accomplish the following:

- Configuring a new drive or jukebox and/or add new volumes for management.
- Removing drives or jukeboxes and/or deleting volumes from management.
- Servicing a jukebox when it is necessary to remove allocated volumes and replace them with scratch volumes.
- Rotating volumes from the onsite location to an offsite location, and back.

The procedures outlined in this section include command examples with recommended qualifier settings shown. If you choose to perform these tasks with the command line interface, use the MDMS command reference for complete command details.

### 13.1 Creating Jukeboxes, Drives, and Volumes

This task offers the complete set of steps for configuring a drive or jukebox to an MDMS domain and adding new volumes used by those drives. This task can be performed to configure a new drive or jukebox that can use managed volumes.

## MDMS High Level Tasks

### 13.1 Creating Jukeboxes, Drives, and Volumes

Figure 13–1 Configuring Volumes and Drives

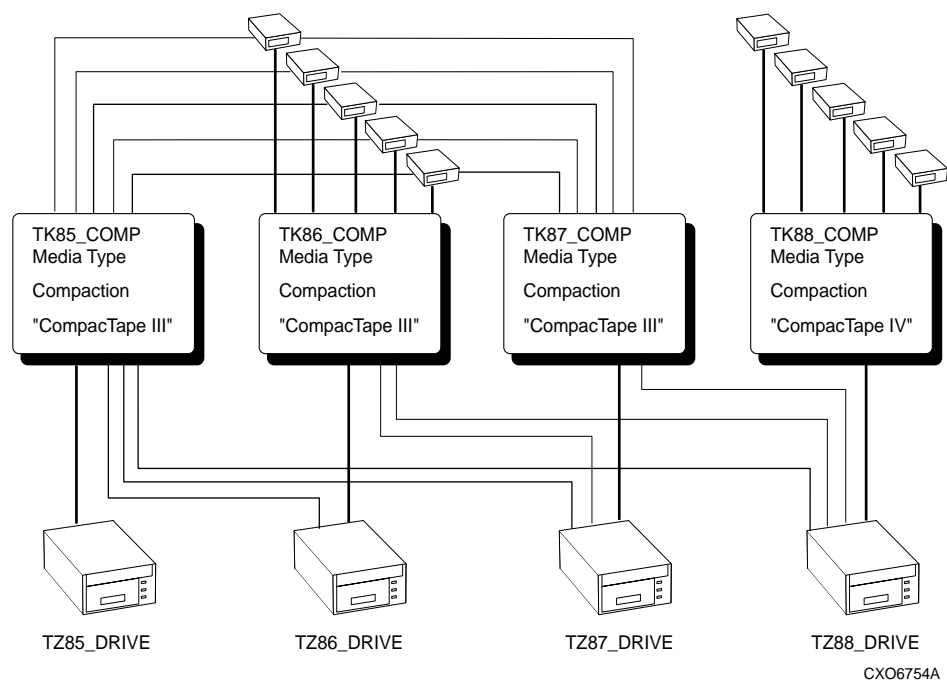

This task can also be performed to add new volumes into management that can use managed drives and jukeboxes.

Table 13–1 Creating Devices and Volumes

Step	Action
<b>Create Jukebox and/or Drive</b>	
1.	Verify that the drive is on-line and available. <pre>\$SHOW DEVICE device_name /FULL</pre> Verify that the jukebox is online and available. <pre>\$SHOW DEVICE device_name /FULL</pre>
2.	If you are connecting the jukebox or drive to a set of nodes which do not already share access to a common device, then create a group object record. <pre>\$MDMS CREATE GROUP group_name /NODES=(node_1,...)</pre>
3.	If you are configuring a new jukebox into management, then create a jukebox object record. <pre>\$MDMS CREATE JUKEBOX jukebox_name /DISABLED</pre>
4.	If the drive you are configuring uses a new type of volume, then create a media type object record. <pre>\$MDMS CREATE MEDIA_TYPE media_type</pre>
5.	If you need to identify a new place for volume storage near the drive, then create a location object record. <pre>\$MDMS CREATE LOCATION location_name</pre>

## MDMS High Level Tasks

### 13.1 Creating Jukeboxes, Drives, and Volumes

**Table 13–1 Creating Devices and Volumes**

Step	Action
6.	<p>Create the drive object record for the drive you are configuring into MDMS management.</p> <pre>\$MDMS CREATE DRIVE <i>drive_name</i> /DISABLED</pre>
7.	<p>Enable the drive (and if you just added a jukebox, enable it too).</p> <pre>\$MDMS SET DRIVE <i>drive_name</i> /ENABLED \$MDMS SET JUKEBOX <i>jukebox_name</i> /ENABLED</pre>
8.	<p>If you are adding new volumes into MDMS management, then continue with Step 10.</p>
9.	<p>If you have added a new media type to complement a new type of drive, and you plan to use managed volumes, set the volumes to use the new media type.</p> <pre>\$MDMS SET VOLUME /MEDIA_TYPE=<i>media_type_name</i></pre>
<b>Process New Volumes</b>	
10.	<p>Make sure all new volumes have labels.</p>
11.	<p>If the volumes you are processing are of a type you do not presently manage, complete the actions in this step. Otherwise, continue with Step 12. Create a media type object record.</p> <pre>\$MDMS CREATE MEDIA_TYPE <i>media_type</i></pre> <p>If the drives you manage do not accept the new media type, then set the drives to accept volumes of the new media type.</p> <pre>\$MDMS SET DRIVE /MEDIA_TYPE=<i>media_type</i></pre>
12.	<p>If you are using a jukebox with a vision system to create volume object records, then continue with Step 13. Otherwise, continue with Step 16 to create volume records.</p>
<b>Jukebox Inventory to Create Volume Object Records</b>	
13.	<p>If you use magazines in your operation, then continue with this step. Otherwise, continue with Step 14.</p> <p>If you do not have a managed magazine that is compatible with the jukebox, then create a magazine object record.</p> <pre>\$MDMS CREATE MAGAZINE <i>magazine_name</i></pre> <p>Place the volumes in the magazine. Move the magazine into the jukebox.</p> <pre>\$MDMS MOVE MAGAZINE <i>magazine_name</i> <i>jukebox_name</i> /START_SLOT=<i>n</i> or \$MDMS MOVE MAGAZINE <i>magazine_name</i> <i>jukebox_name</i> /START_SLOT=(<i>n,n,n</i>)</pre>
14.	<p>Place the volumes in the jukebox. If you are not using all the slots in the jukebox, note the slots you are using for this operation.</p> <p>Inventory the jukebox, or just the slots that contain the new volumes. If you are processing pre-initialized volumes, use the /PREINITIALIZED qualifier, then your volumes are ready for use.</p> <pre>\$MDMS INVENTORY JUKEBOX <i>jukebox_name</i> /CREATE /VOLUME_RANGE=<i>range</i></pre>

## MDMS High Level Tasks

### 13.2 Deleting Jukeboxes, Drives, and Volumes

**Table 13–1 Creating Devices and Volumes**

Step	Action
15.	<p>Initialize the volumes in the jukebox if they were not created as preinitialized.</p> <pre>\$MDMS INITIALIZE VOLUME /JUKEBOX=<i>jukebox_name</i> /SLOTS=<i>range</i></pre> <p>After you initialize volumes, you are done with this procedure.</p>
<b>Create Volume Object Records Explicitly</b>	
16.	<p>Create volume object records for the volumes you are going to manage. If you are processing preinitialized volumes, use the /PREINITIALIZED qualifier, then your volumes are ready for use.</p> <pre>\$MDMS CREATE VOLUME <i>volume_id</i></pre>
17.	<p>Initialize the volumes. This operation will direct the operator when to load and unload the volumes from the drive.</p> <pre>\$MDMS INITIALIZE VOLUME <i>volume_range</i> /ASSIST</pre>

## 13.2 Deleting Jukeboxes, Drives, and Volumes

This task describes the complete set of decisions and actions you could take in the case of removing a drive from management. That is, when you have to remove the last drives of a particular kind, and take with it all associated volumes, then update any remaining MDMS object records that reference the object records you delete. Any other task of removing just a drive (one of many to remain) or removing and discarding volumes involves a subset of the activities described in this procedure.

**Table 13–2 Deleting Devices and Volumes**

Step	Action
1.	<p>If there is a volume in the drive you are about to remove from management, then unload the volume from the drive.</p> <pre>\$MDMS UNLOAD DRIVE <i>drive_name</i></pre>
2.	<p>Delete the drive from management.</p> <pre>\$MDMS DELETE DRIVE <i>drive_name</i></pre>
3.	<p>If you have media type object records to service only the drive you just deleted, then complete the actions in this step. Otherwise, continue with Step 4.</p> <p>Delete the media type object record.</p> <pre>\$MDMS DELETE MEDIA TYPE <i>media_type</i></pre> <p>If volumes remaining in management reference the media type, then set the volume attribute value for those volumes to reference a different media type value. Use the following command for uninitialized volumes:</p> <pre>\$MDMS SET VOLUME /MEDIA_TYPE=<i>media_type</i> /REMOVE</pre> <p>Use the following command for initialized volumes:</p> <pre>\$MDMS SET VOLUME /MEDIA TYPE=<i>media_type</i></pre>



**Table 13–2 Deleting Devices and Volumes**

Step	Action
4.	<p>If the drives you have deleted belonged to a jukebox, then complete the actions in this step. Otherwise, continue with Step 5.</p> <p>If the jukebox still contains volumes, move the volumes (or magazines, if you manage the jukebox with magazines) from the jukebox to a location that you plan to keep under MDMS management.</p> <pre>\$MDMS MOVE VOLUME <i>volume_id</i> <i>location</i></pre> <p>or</p> <pre>\$MDMS MOVE MAGAZINE <i>magazine_name</i> <i>location</i></pre>
5.	<p>If a particular location served the drives or jukebox, and you no longer have a need to manage it, then delete the location.</p> <pre>\$MDMS DELETE LOCATION <i>location_name</i></pre>
6.	<p>Move all volumes, the records of which you are going to delete, to a managed location.</p> <pre>\$MDMS MOVE VOLUME <i>volume_id</i> <i>location</i></pre>
7.	<p>If the volumes to be deleted exclusively use a particular media type, and that media type has a record in the MDMS database, then take the actions in this step. Otherwise, continue with Step 8.</p> <p>Delete the media type object record.</p> <pre>\$MDMS DELETE MEDIA_TYPE <i>media_type</i></pre> <p>If drives remaining under MDMS management reference the media type you just deleted, then update the drives' media type list accordingly.</p> <pre>\$MDMS SET DRIVE /MEDIA_TYPE <i>media_type</i> /REMOVE</pre>
8.	<p>If the volumes to be deleted are the only volumes to belong to a volume pool, and there is no longer a need for the pool, then delete the volume pool.</p> <pre>\$MDMS DELETE POOL <i>pool_name</i></pre>
9.	<p>If the volumes to be deleted exclusively used certain managed magazines, then delete the magazines.</p> <pre>\$MDMS DELETE MAGAZINE <i>magazine_name</i></pre>
10.	<p>Delete the volumes.</p> <pre>\$MDMS DELETE VOLUME <i>volume_id</i></pre>

## 13.3 Rotating Volumes Between Sites

This procedure describes how to gather and rotate volumes from the onsite location to an offsite location. Use this procedure in accordance with your data center site rotation schedule to move backup copies of data (or data destined for archival) to an offsite location. Additionally, this procedure processes volumes from the offsite location into the onsite location.

## MDMS High Level Tasks

### 13.3 Rotating Volumes Between Sites

Figure 13–2 Volume Rotation

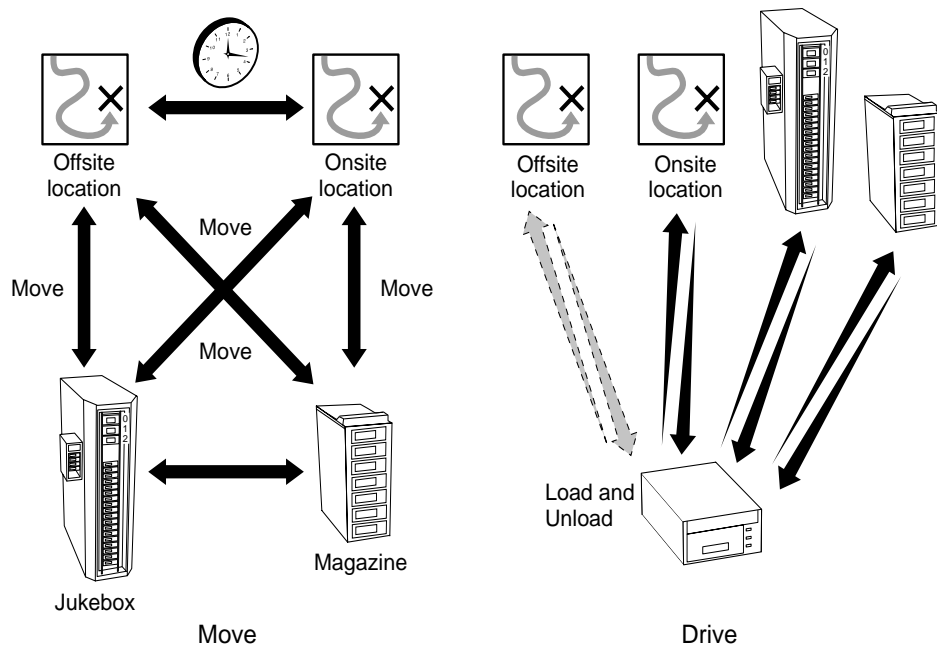

CXO6753A

Table 13–3 Rotating Volumes Between Sites

Step	Action
1.	<p>Prepare a report listing the offsite volumes or magazines due for rotation to your onsite location.</p> <pre>\$MDMS REPORT VOLUME/SCHEDULE=ONSITE</pre> <p>or,</p> <pre>\$MDMS SHOW MAGAZINE/SCHEDULE=ONSITE</pre> <p>Provide this information to the people responsible for shuttling volumes and magazines.</p>
2.	<p>Identify the volumes and/or magazines to move offsite.</p> <pre>\$MDMS SHOW VOLUME /SCHEDULE=OFFSITE</pre> <p>or,</p> <pre>\$MDMS SHOW MAGAZINE /SCHEDULE=OFFSITE</pre>
3.	<p>Gather the volumes into your location. If you have to retrieve magazines and/or volumes from a jukebox, then move those volumes and/or magazines out of the jukebox. Move them to an onsite location from which they will be shipped offsite.</p> <pre>\$MDMS MOVE VOLUME /SCHEDULE=OFFSITE location</pre> <p>or,</p> <pre>\$MDMS MOVE MAGAZINE /SCHEDULE=OFFSITE location</pre>

## MDMS High Level Tasks

### 13.4 Servicing Jukeboxes Used for Backup Operations

**Table 13–3 Rotating Volumes Between Sites**

Step	Action
4.	<p>As the volumes are picked up for transportation, or when otherwise convenient, update the volume and/or magazine records in the database. Specify the offsite location name in this command.</p> <pre>\$MDMS MOVE VOLUME /SCHEDULE=OFFSITE <i>location</i></pre> <p>or,</p> <pre>\$MDMS MOVE MAGAZINE /SCHEDULE=OFFSITE <i>location</i></pre>
5.	<p>With MDMS, move the volumes and/or magazines to the onsite location.</p> <pre>\$MDMS MOVE VOLUME /SCHEDULE=ONSITE <i>location</i></pre> <p>or,</p> <pre>\$MDMS MOVE MAGAZINE /SCHEDULE=ONSITE <i>location</i></pre>
6.	<p>Prepare spaces for the incoming volumes and magazines. This can be accomplished by moving volumes and magazines into jukeboxes, or placing them in other locations to support operations.</p>

## 13.4 Servicing Jukeboxes Used for Backup Operations

This procedure describes the steps you take to move allocated volumes from a jukebox and replace them with scratch volumes. This procedure is aimed at supporting backup operations, not operations that involve the use of managed media for hierarchical storage management.

**Figure 13–3 Magazine Placement**

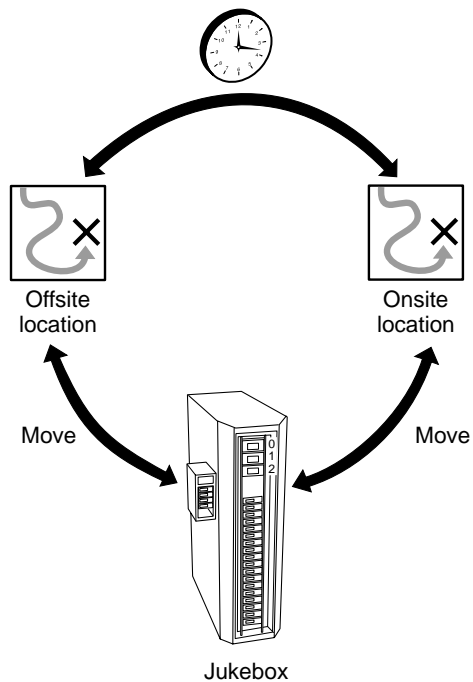

CXO6752A

## MDMS High Level Tasks

### 13.4 Servicing Jukeboxes Used for Backup Operations

#### Note

This procedure supports backup operations. Do not remove volumes allocated to HSM unless a response to a load request can be tolerated when moving the volume to the jukebox.

**Table 13–4 Servicing Jukeboxes**

Step	Action
1.	Report on the volumes to remove from the jukebox.  \$MDMS REPORT VOLUME ALLOCATED /USER=ABS
2.	If you manage the jukebox on a volume basis, perform this step with each volume, otherwise proceed with Step 3 with instructions for magazine management.  \$MDMS MOVE VOLUME <i>volume_id</i> <i>location</i>
3.	Identify the magazines to which the volumes belong, then move the magazines from the jukebox.  \$MDMS SHOW VOLUME /MAGAZINE <i>volume_id</i>  then  \$MDMS MOVE MAGAZINE <i>magazine_name</i> <i>location_name</i>
4.	If you manage the jukebox on a volume basis, perform this step, otherwise proceed with Step 5 for magazine management.  \$MDMS MOVE MAGAZINE <i>magazine_name</i> <i>location</i>
5.	Move free volumes to the magazine, and move the magazine to the jukebox.  \$MDMS MOVE VOLUME <i>volume_id</i> <i>magazine_name</i>  then  \$MDMS MOVE MAGAZINE <i>magazine_name</i> <i>jukebox_name</i>

---

## Remote Devices

This chapter explains how to configure and manage remote devices using the Remote Device Facility (RDF). RDF is used for devices remotely connected over a wide-area network, and DECnet is still a requirement for access to these remote devices. RDF is not required for devices connected remotely via Fibre Channel, as these are considered local devices.

### 14.1 The RDF Installation

When you install ABS (non-standard installation) or MDMS, you are asked whether you want to install the RDF software. With the ABS standard installation, the RDF client and server software is installed by default.

During the installation you place the RDF client software on the nodes with disks you want to access for ABS or HSM. You place the RDF server software on the systems to which the tape devices (jukeboxes and drives) are connected. This means that when using RDF, you serve the tape device to the systems with the client disks.

All of the files for RDF are placed in `SY$COMMON:[MDMS.TTI_RDF]` for your system. There are separate locations for VAX or Alpha.

---

**Note**

---

**RDF is not available if you are running ABS/MDMS with the ABS-OMT license.**

---

### 14.2 Configuring RDF

After installing RDF you should check the `TTI_RDEV:CONFIG_nodename.DAT` file to make sure it has correct entries.

This file:

- is located on the RDF server node with the tape device
- is created initially during installation
- is a text file
- includes the definition of each device accessible by the RDF software. This definition consists of a physical device name and an RDF characteristic name.

**Example:**

```
Device $1$MIA0 MIA0
```

**Verify:**

Check this file to make sure that all RDF characteristic names are unique to this node.

## Remote Devices

### 14.3 Using RDF with MDMS

## 14.3 Using RDF with MDMS

The following sections describe how to use RDF with MDMS.

### 14.3.1 Starting Up and Shutting Down RDF Software

#### Starting up RDF software:

RDF software is automatically started up along with then MDMS software when you enter the following command:

```
$ @SYS$STARTUP:MDMS$STARTUP
```

#### Shutting down RDF software:

To shut down the RDF software, enter the following command:

```
$ @SYS$STARTUP:MDMS$SHUTDOWN
```

### 14.3.2 The RDSHOW Procedure

#### Required privileges:

The following privileges are required to execute the RDSHOW procedure: NETMBX, TMP-MBX.

In addition, the following privileges are required to show information on remote devices allocated by other processes: SYSPRV, WORLD.

### 14.3.3 Command Overview

You can run the RDSHOW procedure any time after the MDMS software has been started. RDF software is automatically started at this time.

Use the following procedures:

```
$ @TTI_RDEV:RDSHOW CLIENT
$ @TTI_RDEV:RDSHOW SERVER node_name
$ @TTI_RDEV:RDSHOW DEVICES
```

node\_name is the node name of any node on which the RDF server software is running.

### 14.3.4 Showing Your Allocated Remote Devices

To show remote devices that you have allocated, enter the following command from the RDF client node:

```
$ @TTI_RDEV:RDSHOW CLIENT
```

#### Result:

```
RDALLOCATED devices for pid 20200294, user DJ, on node OMAHA::
Local logical      Rmt node  Remote device
TAPE01             MIAMI::   MIAMI$MUCO
```

DJ is the user name and OMAHA is the current RDF client node.

## 14.4 Monitoring and Tuning Network Performance

### 14.3.5 Showing Available Remote Devices on the Server Node

The RDSHOW SERVER procedure shows the available devices on a specific SERVER node. To execute this procedure, enter the following command from any RDF client or RDF server node:

```
$ @TTI_RDEV:RDSHOW SERVER MIAMI
```

MIAMI is the name of the server node whose devices you want shown.

#### **Result:**

```
Available devices on node MIAMI::
Name          Status Characteristics/Comments
MIAMI$MSA0    in use  msa0
...by pid 20200246, user CATHY (local)
MIAMI$MUA0    in use  mua0
...by pid 202001B6, user CATHY, on node OMAHA::
MIAMI$MUB0    -free-  mub0
MIAMI$MUC0    in use  muc0
...by pid 2020014C, user DJ, on node OMAHA::
```

This RDSHOW SERVER command shows any available devices on the server node MIAMI, including any device characteristics. In addition, each allocated device shows the process PID, username, and RDF client node name.

The text (local) is shown if the device is locally allocated.

### 14.3.6 Showing All Remote Devices Allocated on the RDF Client Node

To show all allocated remote devices on an RDF client node, enter the following command from the RDF client node:

```
$ @TTI_RDEV:RDSHOW DEVICES
```

#### **Result:**

```
Devices RDALLOCATED on node OMAHA::
RDdevice Rmt node Remote device User name PID
RDEVA0:   MIAMI::   MIAMI$MUC0   DJ      2020014C
RDEVB0:   MIAMI::   MIAMI$MUA0   CATHY   202001B6
```

This command shows all allocated devices on the RDF client node OMAHA. Use this command to determine which devices are allocated on which nodes.

## 14.4 Monitoring and Tuning Network Performance

This section describes network issues that are especially important when working with remote devices.

### 14.4.1 DECnet Phase IV

The Network Control Program (NCP) is used to change various network parameters. RDF (and the rest of your network as a whole) benefits from changing two NCP parameters on all nodes in your network. These parameters are:

- PIPELINE QUOTA
- LINE RECEIVE BUFFERS

## Remote Devices

### 14.4 Monitoring and Tuning Network Performance

#### Pipeline quota

The pipeline quota is used to send data packets at an even rate. It can be tuned for specific network configurations. For example, in an Ethernet network, the number of packet buffers represented by the pipeline quota can be calculated as approximately:

```
buffers = pipeline_quota / 1498
```

#### **Default:**

The default pipeline quota is 10000. At this value, only six packets can be sent before acknowledgment of a packet from the receiving node is required. The sending node stops after the sixth packet is sent if an acknowledgment is not received.

#### **Recommendation:**

The PIPELINE QUOTA can be increased to 45,000 allowing 30 packets to be sent before a packet is acknowledged (in an Ethernet network). However, performance improvements have not been verified for values higher than 23,000. It is important to know that increasing the value of PIPELINE QUOTA improves the performance of RDF, but may negatively impact performance of other applications running concurrently with RDF.

#### Line receive buffers

Similar to the pipeline quota, line receive buffers are used to receive data at a constant rate.

#### **Default:**

The default setting for the number of line receive buffers is 6.

#### **Recommendation:**

The number of line receive buffers can be increased to 30 allowing 30 packets to be received at a time. However, performance improvements have not been verified for values greater than 15 and as stated above, tuning changes may improve RDF performance while negatively impacting other applications running on the system.

#### 14.4.2 DECnet-Plus (Phase V)

As stated in DECnet-Plus(Phase V), (DECnet/OSI V6.1) Release Notes, a pipeline quota is not used directly. Users may influence packet transmission rates by adjusting the values for the transport's characteristics MAXIMUM TRANSPORT CONNECTIONS, MAXIMUM RECEIVE BUFFERS, and MAXIMUM WINDOW. The value for the transmit quota is determined by MAXIMUM RECEIVE BUFFERS divided by Actual TRANSPORT CONNECTIONS.

This will be used for the transmit window, unless MAXIMUM WINDOW is less than this quota. In that case, MAXIMUM WINDOW will be used for the transmitter window.

The DECnet-Plus defaults (MAXIMUM TRANSPORT CONNECTIONS = 200 and MAXIMUM RECEIVE BUFFERS = 4000) produce a MAXIMUM WINDOW of 20. Decreasing MAXIMUM TRANSPORT CONNECTIONS with a corresponding increase of MAXIMUM WINDOW may improve RDF performance, but also may negatively impact other applications running on the system.

#### 14.4.3 Changing Network Parameters

This section describes how to change the network parameters for DECnet Phase IV and DECnet-PLUS.



## 14.4 Monitoring and Tuning Network Performance

## 14.4.4 Changing Network Parameters for DECnet (Phase IV)

The pipeline quota is an NCP executor parameter. The line receive buffers setting is an NCP line parameter.

The following procedure shows how to display and change these parameters in the permanent DECnet database. These changes should be made on each node of the network.

**Table 14–1 How to Change Network Parameters**

Step	Action
1	<p>Enter:</p> <pre>\$ run sys\$system:NCP NCP&gt;show executor characteristics</pre> <p>Result:</p> <pre>Node Permanent Characteristics as of 24-MAY-1991 10:10:58 Executor node = 20.1 (DENVER) Management version = V4.0A.0 . . . Pipeline quota = 10000</pre>
2	<p>Enter:</p> <pre>NCP&gt;define executor pipeline quota 45000 NCP&gt;show known lines</pre> <p><u>Result:</u></p> <pre>Known line Volatile Summary as of 24-MAY-1991 10:11:13 Line      State SVA-0    on</pre>
3	<p>Enter:</p> <pre>NCP&gt;show line sva-0 characteristics</pre> <p><u>Result:</u></p> <pre>Line Permanent Characteristics as of 24-MAY-1991 10:11:31 Line = SVA-0 Receive buffers           = 6      &lt;-- value to change Controller                = normal Protocol                  = Ethernet Service timer             = 4000 Hardware address          = 08-00-2B-0D-D0-5F Device buffer size        = 1498</pre>
4	<p>Enter:</p> <pre>NCP&gt;define line sva-0 receive buffers 30 NCP&gt;exit</pre>

**Requirement:**

For the changed parameters to take effect, the node must be rebooted or DECnet must be shut down.

## Remote Devices

### 14.4 Monitoring and Tuning Network Performance

#### 14.4.5 Changing Network Parameters for DECnet-Plus(Phase V)

The Network Control Language (NCL) is used to change DECnet-Plus network parameters. The transport parameters MAXIMUM RECEIVE BUFFERS, MAXIMUM TRANSPORT CONNECTIONS and MAXIMUM WINDOW can be adjusted by using NCL's SET OSI TRANSPORT command. For example:

```
NCL> SET OSI TRANSPORT MAXIMUM RECEIVE BUFFERS = 4000      !default value
NCL> SET OSI TRANSPORT MAXIMUM TRANSPORT CONNECTIONS = 200 !default value
NCL> SET OSI TRANSPORT MAXIMUM WINDOWS = 20                !default value
```

To make the parameter change permanent, add the NCL command(s) to the SYSS\$MANAGER:NET\$OSI\_TRANSPORT\_STARTUP.NCL file. Refer to the DENET-Plus (DECnet/OSI) Network Management manual for detailed information.

#### 14.4.6 Resource Considerations

Changing the default values of line receive buffers and the pipeline quota to the values of 30 and 45000 consumes less than 140 pages of nonpaged dynamic memory.

In addition, you may need to increase the number of large request packets (LRPs) and raise the default value of NETACP BYTLM.

##### Large request packets

LRPs are used by DECnet to send and receive messages. The number of LRPs is governed by the SYSGEN parameters LRPCOUNT and LRPCOUNTV.

##### Recommendation:

A minimum of 30 free LRPs is recommended during peak times. Show these parameters and the number of free LRPs by entering the following DCL command:

```
$ SHOW MEMORY/POOL/FULL
```

##### Result:

```
System Memory Resources on 24-JUN-1991 08:13:57.66
Large Packet (LRP) Lookaside List Packets Bytes
Current Total Size                36      59328
Initial Size (LRPCOUNT)           25      41200
Maximum Size (LRPCOUNTV)          200     329600
Free Space                          20      32960
```

In the LRP lookaside list, this system has:

- Current Total Size of 36

The SYSGEN parameter LRPCOUNT (LRP Count) has been set to 25. The Current Size is not the same as the Initial Size. This means that OpenVMS software has to allocate more LRPs. This causes system performance degradation while OpenVMS is expanding the LRP lookaside list.

The LRPCOUNT should have been raised to at least 36 so OpenVMS does not have to allocate more LRPs.

## 14.4 Monitoring and Tuning Network Performance

### **Recommendation:**

Raise the LRPCOUNT parameter to a minimum of 50. Because the LRPCOUNT parameter is set to only 25, the LRPCOUNT parameter is raised on this system even if the current size was also 25.

- Free Space is 20

This is below the recommended free space amount of 30. This also indicates that LRPCOUNT should be raised. Raising LRPCOUNT to 50 (when there are currently 36 LRPs) has the effect of adding 14 LRPs. Fourteen plus the 20 free space equals over 30. This means that the recommended value of 30 free space LRPs is met after LRPCOUNT is set to 50.

- The SYSGEN parameter LRPCOUNTV (LRP count virtual) has been set to 200.

The LRPCOUNTV parameter should be at least four times LRPCOUNT. Raising LRPCOUNT may mean that LRPCOUNTV has to be raised. In this case, LRPCOUNTV does not have to be raised because 200 is exactly four times 50 (the new LRPCOUNT value).

Make changes to LRPCOUNT or LRPCOUNTV in both:

- SYSGEN (using CURRENT)
- SYS\$SYSTEM:MODPARAMS.DAT file (for when AUTOGEN is run with REBOOT)

### **Example: Changing LRPCOUNT to 50 in SYSGEN**

```
Username: SYSTEM
Password: (the system password)
$ SET DEFAULT SYS$SYSTEM
$ RUN SYSGEN
SYSGEN> USE CURRENT
SYSGEN> SH LRPCOUNT
Parameter Name           Current   Default   Minimum   Maximum
LRPCOUNT                 25       4         0         4096
SYSGEN> SET LRPCOUNT 50
SYSGEN> WRITE CURRENT
SYSGEN> SH LRPCOUNT
Parameter Name           Current   Default   Minimum   Maximum
LRPCOUNT                 50       4         0         4096
```

### **Requirement:**

After making changes to SYSGEN, reboot your system so the changes take effect.

### **Example: Changing the LRPCOUNT for AUTOGEN**

Add the following line to MODPARAMS.DAT:

```
$ MIN_LRPCOUNT = 50      ! ADDED {the date} {your initials}
```

### **Result:**

This ensures that when AUTOGEN runs, LRPCOUNT is not set below 50.

## **NETACP BYTLM**

The default value of NETACP is a BYTLM setting of 65,535. Including overhead, this is enough for only 25 to 30 line receive buffers. This default BYTLM may not be enough.

### **Recommendation:**

Increase the value of NETACP BYTLM to 110,000.

## Remote Devices

### 14.4 Monitoring and Tuning Network Performance

#### **How to increase NETACP BYTLM:**

Before starting DECnet, define the logical NETACP\$BUFFER\_LIMIT by entering:

```
$ DEFINE/SYSTEM/NOLOG NETACP$BUFFER_LIMIT 110000
$ @SYS$MANAGER:STARTNET.COM
```

#### 14.4.7 Controlling RDF's Effect on the Network

By default, RDF tries to perform I/O requests as fast as possible. In some cases, this can cause the network to slow down. Reducing the network bandwidth used by RDF allows more of the network to become available to other processes.

The RDF logical names that control this are:

```
RDEV_WRITE_GROUP_SIZE
RDEV_WRITE_GROUP_DELAY
```

#### **Default:**

The default values for these logical names is zero. The following example shows how to define these logical names on the RDF client node:

```
$ DEFINE/SYSTEM RDEV_WRITE_GROUP_SIZE 30
$ DEFINE/SYSTEM RDEV_WRITE_GROUP_DELAY 1
```

#### **Further reduction:**

To further reduce bandwidth, the RDEV\_WRITE\_GROUP\_DELAY logical can be increased to two (2) or three (3).

---

#### **Note**

**Reducing the bandwidth used by RDF causes slower transfers of RDF's data across the network.**

---

#### 14.4.8 Surviving Network Failures

Remote Device Facility (RDF) can survive network failures of up to 15 minutes long. If the network comes back within the 15 minutes allotted time, the RDCLIENT continues processing WITHOUT ANY INTERRUPTION OR DATA LOSS. When a network link drops while RDF is active, after 10 seconds, RDF creates a new network link, synchronizes I/Os between the RDCLIENT and RDSERVER, and continues processing.

The following example shows how you can test the RDF's ability to survive a network failure. (This example assumes that you have both the RDSERVER and RDCLIENT processes running.)

```
$ @tti_rdev:rdallocate tti::mua0:
RDF - Remote Device Facility (Version 4.1) - RDALLOCATE Procedure
Copyright (c) 1990, 1996 Touch Technologies, Inc.
Device TTI::TTI$MUA0 ALLOCATED, use TAPE01 to reference it
$ backup/rewind/log/ignore=label sys$library:*.* tape01:test
```

*from a second session:*

```
$ run sys$system:NCP
NCP> show known links
```

```
Known Link Volatile Summary as of 13-MAR-1996 14:07:38
Link      Node          PID      Process      Remote link  Remote user
24593    20.4 (JR)        2040111C MARI_11C_5   8244         CTERM
16790    20.3 (FAST)      20400C3A -rdclient-   16791       tti_rdevSRV
24579    20.6 (CHEERS)    20400113 REMACP       8223        SAMMY
```

## Remote Devices

### 14.5 Controlling Access to RDF Resources

```
24585 20.6 (CHEERS) 20400113 REMACP 8224 ANDERSON
NCP> disconnect link 16790
.
.
.
```

Backup pauses momentarily before resuming. Sensing the network disconnect, RDF creates a new `-rdclient-` link. Verify this by entering the following command:

```
NCP> show known links
Known Link Volatile Summary as of 13-MAR-1996 16:07:00

Link      Node      PID      Process      Remote link  Remote user
24593    20.4 (JR)  2040111C MARI_11C_5   8244        CTERM
24579    20.6 (CHEERS) 20400113 REMACP      8223        SAMMY
24585    20.6 (CHEERS) 20400113 REMACP      8224        ANDERSON
24600    20.3 (FAST)  20400C3A -rdclient-   24601      tti_rdevSRV

NCP> exit
```

## 14.5 Controlling Access to RDF Resources

The RDF Security Access feature allows storage administrators to control which remote devices are allowed to be accessed by RDF client nodes.

### 14.5.1 Allow Specific RDF Clients Access to All Remote Devices

You can allow specific RDF client nodes access to all remote devices.

#### **Example:**

For example, if the server node is MIAMI and access to all remote devices is granted only to RDF client nodes OMAHA and DENVER, then do the following:

1. Edit `TTI_RDEV:CONFIG_MIAMI.DAT`
2. Before the first device designation line, insert the `/ALLOW` qualifier

```
Edit TTI_RDEV:CONFIG_MIAMI.DAT
CLIENT/ALLOW=(OMAHA,DENVER)
DEVICE $1$MUA0: MUA0, TK50
DEVICE MSA0: TU80, 1600bpi
```

OMAHA and DENVER (the specific RDF CLIENT nodes) are allowed access to all remote devices (MUA0, TU80) on the server node MIAMI.

#### **Requirements:**

If there is more than one RDF client node being allowed access, separate the node names by commas.

### 14.5.2 Allow Specific RDF Clients Access to a Specific Remote Device

You can allow specific RDF client nodes access to a *specific* remote device.

#### **Example:**

If the server node is MIAMI and access to MUA0 is allowed by RDF client nodes OMAHA and DENVER, then do the following:

1. Edit `TTI_RDEV:CONFIG_MIAMI.DAT`
2. Find the device designation line (for example, `DEVICE $1$MUA0:`)
3. At the end of the device designation line, add the `/ALLOW` qualifier:

## Remote Devices

### 14.6 RDserver Inactivity Timer

```
$ Edit TTI_RDEV:CONFIG_MIAMI.DAT
DEVICE $1$MUA0: MUA0, TK50/ALLOW=(OMAHA,DENVER)
DEVICE MSA0: TU80, 1600bpi
```

OMAHA and DENVER (the specific RDF client nodes ) are allowed access only to device MUA0. In this situation, OMAHA is not allowed to access device TU80.

#### 14.5.3 Deny Specific RDF Clients Access to All Remote Devices

You can deny access from specific RDF client nodes to all remote devices. For example, if the server node is MIAMI and you want to deny access to all remote devices from RDF client nodes OMAHA and DENVER, do the following:

1. Edit TTI\_RDEV:CONFIG\_MIAMI.DAT
2. Before the first device designation line, insert the /DENY qualifier:

```
$ Edit TTI_RDEV:CONFIG_MIAMI.DAT
CLIENT/DENY=(OMAHA,DENVER)
DEVICE $1$MUA0: MUA0, TK50
DEVICE MSA0: TU80, 16700bpi
```

OMAHA and DENVER are the specific RDF client nodes denied access to all the remote devices (MUA0, TU80) on the server node MIAMI.

#### 14.5.4 Deny Specific RDF Clients Access to a Specific Remote Device

You can deny specific client nodes access to a specific remote device.

##### **Example:**

If the server node is MIAMI and you want to deny access to MUA0 from RDF client nodes OMAHA and DENVER, do the following:

1. Edit TTI\_RDEV:CONFIG\_MIAMI.DAT
2. Find the device designation line (for example, DEVICE \$1\$MUA0:)
3. At the end of the device designation line, add the /DENY qualifier:

```
$ Edit TTI_RDEV:CONFIG_MIAMI.DAT
DEVICE $1$MUA0: MUA0, TK50/DENY=(OMAHA,DENVER)
DEVICE MSA0: TU80, 16700bpi
```

OMAHA and DENVER RDF client nodes are denied access to device MUA0 on the server node MIAMI.

### 14.6 RDserver Inactivity Timer

One of the features of RDF is the RDserver Inactivity Timer. This feature gives system managers more control over rdallocated devices.

The purpose of the RDserver Inactivity Timer is to rddeallocate any rdallocated device if NO I/O activity to the rdallocated device has occurred within a predetermined length of time. When the RDserver Inactivity Timer expires, the server process drops the link to the client node and deallocates the physical device on the server node. On the client side, the client process deallocates the RDEVn0 device.

The default value for the RDserver Inactivity Timer is 3 hours.

The RDserver Inactivity Timer default value can be manually set by defining a system wide logical on the RDserver node prior to rdallocating on the rdclient node. The logical name is RDEV\_SERVER\_INACTIVITY\_TIMEOUT.

To manually set the timeout value:

```
$ DEFINE/SYSTEM RDEV_SERVER_INACTIVITY_TIMEOUT seconds
```

For example, to set the RDserver Inactivity Timer to 10 hours, you would execute the following command on the RDserver node:

```
$ DEFINE/SYSTEM RDEV_SERVER_INACTIVITY_TIMEOUT 36000
```

## 14.7 RDF Error Messages

---

CLIDENY	Access from this CLIENT to the SERVER is not allowed. Check for "CLIENT/ALLOW" in the RDserver's configuration file.
CLIENTSBUSY	All 16 pseudo-devices are already in use.
DEVDENY	Client is not allowed to the Device or to the Node. This error message is dependent on the "CLIENT/ALLOW", "/ALLOW" or "CLIENT/DENY", "/DENY" qualifiers in the configuration file. Verify that the configuration file qualifier is used appropriately.
EMPTYCFG	The RDserver's configuration file has no valid devices or they are all commented out.
LINKABORT	The connection to the device was aborted. For some reason the connection was interrupted and the remote device could not be found. Check the configuration file as well as the remote device.
NOCLIENT	The RDdriver was not loaded. Most commonly the RDCLIENT_STARTUP.COM file was not executed for this node.
NOREMOTE	This is a RDF status message. The remote device could not be found. Verify the configuration file as well as the status of the remote device.
SERVERTMO	The RDserver did not respond to the request. Most commonly the RDSERVER_STARTUP.COM file was not executed on the server node. Or, the server has too many connections already to reply in time to your request.

---





---

## HSM Error Messages

This section defines all status and error messages that are produced by or on behalf of HSM, together with the cause and suggested user actions when appropriate.

### A.1 OpenVMS Messages

The following messages are generated by OpenVMS and returned to the user who is initiating a function.

`%SYSTEM-E-DEVICEFULL, device full - allocation failure`

**Explanation:** An attempt to create or extend a file failed because it would exceed the device capacity, and any attempts to free disk space failed or did not free up the required space. Files should be deleted from the disk to free up space. This is an existing OpenVMS message.

`%SYSTEM-E-EXDISKQUOTA, exceeded disk quota`

**Explanation:** An attempt to create or extend a file failed because it would exceed the user disk quota (plus overdraft), and any attempts to free disk space failed or did not free up the required space. The user should either reduce the number of online files, or request additional disk quota. This is an existing OpenVMS message.

`%SYSTEM-E-SHELVED, file is shelved`

**Explanation:** An attempt to access a currently shelved file has failed because unshelving of the file is disallowed. This is a new OpenVMS message for HSM.

`%SYSTEM-E-SHELFERROR, access to shelved file failed`

**Explanation:** An attempt to access (read/write/extend/truncate) a file failed because the file was shelved and HSM could not unshelve it for some reason. HSM adds further information as to the root cause of the error. This is a new OpenVMS message for HSM.

### A.2 Shelf Handler Messages

This section defines all status and error messages that are produced by or on behalf of HSM, together with the cause and suggested user actions when appropriate

The HSM Shelf Handler Process (SHP) performs all preshelving, shelving, unshelving, and unpreshelving operations for HSM. The following status and error messages are generated by the shelf handler process and are either returned to the end-user or to the shelf handler audit and error logs. All shelf handler messages use the message prefix of "HSM".

`%HSM-W-ALLOCFAILED, failed to load/allocate/mount drive drivename`

## HSM Error Messages

### A.2 Shelf Handler Messages

**Explanation:** An error occurred trying to ready the specified drive for operations. The causes could be that the drive is not configured in SMU, or MDMS, or that the drive has another volume mounted, or is otherwise unavailable. Please check the SHP error log and the status of the drive.

```
%HSM-I-ALRPRESHELVED, file filename was already preshelved
```

**Explanation:** A preshelve request was issued for a file that was already preshelved or shelved. No action is required.

```
%HSM-I-ALRSHELVED, file filename was already shelved
```

**Explanation:** A SHELVE/NOONLINE request was issued for a file that was already shelved, and no reshelving is required. No action is required.

```
%HSM-F-BUGCHECK, internal consistency failure
```

**Explanation:** An internal error occurred and the shelf handler process terminated and is automatically restarted. This error is nonrecoverable, and is written to the error log. Please report this problem to Compaq and include relevant entries in the error and audit logs.

```
%HSM-W-CACHEERROR, shelf caching error
```

**Explanation:** An error occurred trying to access a cache disk or a cache file on a preshelve, shelve, or unshelve request, or during a cache flush to tape. Consult the SHP error log for more information.

```
%HSM-I-CACHEFULL, shelf cache full
```

**Explanation:** All disk and MO devices specified as caches have exhausted their capacity as defined by the block size, or the physical size of the device. Either define additional cache devices, or initiate cache flushing using SMU commands. Any preshelve or shelve operations are directed to tape, if defined.

```
%HSM-W-CANCELED, shelving operation canceled, on file filename
```

**Explanation:** The specified request has been canceled due to a specific cancel request, a request that conflicts with another user, or a failure of a multi-operation request. In the last case, please check the SHP error log for more information.

```
%HSM-E-CATOPENERROR, error opening shelf catalog file
```

**Explanation:** An unexpected error occurred trying to open the shelf catalog file(s). Consult the SHP error log for further information. Please check the equivalence name of HSM\$CATALOG and redefine as needed. Also verify that any catalog files are accessible.

```
%HSM-E-CATSTATS_ERROR, error manipulating catalog statistics record
```

**Explanation:** An error occurred reading or writing the shelf catalog during a license capacity scan or SMU facility definition. Please check the equivalence name of HSM\$CATALOG and redefine as needed. If the catalog exists, you may need to recover the catalog from a BACKUP copy.

```
%HSM-E-CLASS_DISABLED, command class disabled; re-enable with SMU SET FACILITY/REENABLE
```

## HSM Error Messages

### A.2 Shelf Handler Messages

**Explanation:** A repeated fatal error in the shelf handler has been detected on a certain class of operations. Please refer to the SHP error log for detailed information, and report the problem to Compaq. Since the fatal error continually repeats, HSM disabled the class of operation causing the problem, so that other operations might proceed. After fixing the problem, you can re-enable all operations using SMU SET FACILITY/REENABLE.

```
%HSM-E-CLASSDIS, commandclass command class disabled
```

**Explanation:** A repeated fatal error in the shelf handler has been detected on the specified class of operations. Please refer to the error log for detailed information, and report the problem to Compaq. Since the fatal error continually repeats, HSM disabled this class of operation, so that other operations might proceed. After fixing the problem, you can re-enable all operations using SMU SET FACILITY/REENABLE.

```
%HSM-E-DBACCESS_ERROR, unable to access SMU database
```

**Explanation:** The shelf handler process could not access one or more of the SMU databases. Please check the equivalence name of HSM\$MANAGER and redefine as needed. If the database does not exist, you can create a new version by simply running SMU and answering "Yes" to the create questions - then use SMU SET commands to configure HSM.

```
%HSM-E-DBDATA_ERROR, consistency error in SMU database
```

**Explanation:** A consistency error was detected in the SMU database. This could be from the number of archive classes exceeding the maximum allowed for a shelf, an invalid shelf definition, inconsistent definitions, etc. Please examine the error log, then enter SMU SET commands to correct the discrepancy.

```
%HSM-E-DBNOTIFY_ERROR, propagation error for SMU update to all shelf handlers
```

**Explanation:** There was a problem notifying all shelf handlers in the VMScluster™ about a change to an SMU database. Please retry the SMU command, and report the problem to Compaq if the problem persists.

```
%HSM-E-DEVICEIDERR, error accessing volume identifier
```

**Explanation:** An error occurred trying to access or create the file [000000]HSM\$UID.SYS on a disk volume or cache device. Please check the volume for read/write accessibility, and ensure there is sufficient space to create this file (only one cluster factor is usually required). This file is required on all disk volumes for which HSM operations are enabled.

```
%HSM-S-DMPACTREQS, shelving facility active with n requests
```

**Explanation:** Normal response to an SMU SHOW REQUESTS command with "n" active requests. The messages indicates the number of requests active on the shelf handler on the node from which the command was entered, not cluster-wide.

```
%HSM-I-DMPFILE, active requests dumped to file HSM$LOG:HSM$SHP_ ACTIVITY.LOG
```

**Explanation:** Normal response to an SMU SHOW REQUESTS/FULL command, indicating that the activity log was dumped to the fixed-named file. This message (and the activity log) are only produced if there is at least one active request.

```
%HSM-W-DMPNOMUTEX, unable to lock shelf handler database
```

## HSM Error Messages

### A.2 Shelf Handler Messages

**Explanation:** An SMU SHOW REQUESTS operation proceeds even if it cannot lock the appropriate mutexes after 5 seconds. This might occasionally be seen under heavy load and is not a concern. However, if repeated requests display this message, the shelf handler might be hung and a shutdown /restart may be necessary. When this message occurs, any resulting activity log may contain entries with incomplete data.

`%HSM-S-DMPNOREQS, shelving facility idle with no requests`

**Explanation:** Normal response to an SMU SHOW REQUESTS when HSM has no outstanding requests. No activity log is generated on /FULL. Note that there may be outstanding requests on other shelf handlers in the VMScluster™ environment.

`%HSM-F-DUPPROCESS, shelf handler already active`

**Explanation:** An SMU START command was issued while a shelf handler was already active on the node. Either no action is required, or SHUTDOWN the current shelf handler and retry the START.

`%HSM-E-EXCEEDED, The licensed product has exceeded current license limits`

**Explanation:** On an attempt to shelve a file, you have exceeded the capacity defined in your HSM license. You can either purchase a license upgrade, delete some shelved files, or do no more shelving. However, all other operations are unaffected and will succeed.

`%HSM-E-EXDISKQUOTA, unshelve operation exceeds disk quota`

**Explanation:** An attempt to unshelve (or access a shelved file) fails because the unshelve would exceed the file owner's disk quota. You can define a policy to shelve other files to be initiated on this condition. Otherwise, you should shelve/delete other files to free sufficient capacity to allow this unshelve to proceed.

`%HSM-I-EXIT, HSM shelving facility terminated on node nodename`

**Explanation:** This audit log message indicates that the HSM shelf handler terminated on the named node. In the case of a fatal error, the shelf handler is normally restarted. In the case of an SMU SHUTDOWN, it must be manually restarted.

`%HSM-E-FILEERROR, file filename access error`

**Explanation:** HSM was unable to access or read the specified file from the online system. This is written to the error log. This usually means that the file is opened by another user (including HSM on another node), but could also mean the file has been deleted or is otherwise unavailable. Retry the operation later.

`%HSM-E-HWPOLDIS, high-water mark policy execution disabled on volume volumename`

**Explanation:** This message indicates that a high-water mark condition was detected but the policy execution for this condition is disabled, and no policy was run on the volume. No action is required if this is desired, but it is recommended that the policy is enabled.

`%HSM-E-INCOMEDIA, Volume volumename media type mediatype inconsistent with drive drivename media type mediatype`

**Explanation:** This message appears in Basic Mode only, and indicates that the shelf handler has detected a discrepancy in the media type used for shelving a file, and that requested for unshelving it. You should re-check the media type with SMU LOCATE/FULL and reset the SMU databases as needed. This should not normally occur.

`%HSM-E-INCOMEDIATYPE, volume media type inconsistent with drive`

## HSM Error Messages

### A.2 Shelf Handler Messages

**Explanation:** This message appears in Basic Mode only, and means that the drive(s) specified for an archive class cannot physically handle the media type of a tape volume containing a file requested to be unshelved. Please re-check the SMU DEVICE and ARCHIVE definitions.

```
%HSM-E-INCONSTATE, file filename has inconsistent state for unshelving
```

**Explanation:** The state of the file is inconsistent for unshelving, and allowing an unshelve may cause loss or overwriting of valid data. The file may be unshelved using the UNSHELVE/OVERRIDE qualifier, which requires BYPASS privilege. After unshelving the file, it should be checked for data integrity, especially with regards to being the right version of the data.

```
%HSM-E-INELIGPRESHLV, file filename is ineligible for preshelving
```

**Explanation:** The file is ineligible for preshelving. Reasons might include a SET FILE/NOSHELVABLE operation on the file, the file resides on an ineligible disk, the filename begins with HSM\$ or the file is too large.

```
%HSM-E-INELIGSHLV, file filename is ineligible for shelving
```

**Explanation:** The file is ineligible for shelving. Reasons might include a SET FILE/NOSHELVABLE operation on the file, the file resides on an ineligible disk, the filename begins with HSM\$ or the file is too large.

```
%HSM-E-INELIGUNPRESHLV, file filename is ineligible for unpreshelving
```

**Explanation:** The file is ineligible for unpreshelving because it is currently shelved. The file must be unshelved first.

```
%HSM-E-INELIGUNSHLV, file filename is ineligible for unshelving
```

**Explanation:** The file is ineligible for unshelving, because of its type (directory file, file marked for delete or locked, etc.). These should not normally be shelved in the first place.

```
%HSM-E-INELIGVOL, volume is ineligible for HSM operations
```

**Explanation:** The volume is ineligible for HSM operations because of an SMU SET VOLUME/DISABLE=operation, or is a remote volume of some type (including DFS-mounted and NFS-mounted volumes).

```
%HSM-F-INITFAILED, shelf initialization failed
```

**Explanation:** There was a problem starting the shelf handler process. Please refer to the error log for more details, correct problem, and retry.

```
%HSM-F-INSPRIV, insufficient privilege for HSM operation
```

**Explanation:** The HSM\$SERVER account does not contain sufficient privileges to run HSM. Although this is configured properly during installation, it could be changed later. Please refer to the SMU STARTUP command in the Guide to Operations to set the appropriate privileges for this account.

```
%HSM-E-MAILSND, error sending to distribution maillist
```

**Explanation:** The policy execution process encountered an error sending mail to this distribution list or user. If a distribution list was specified for the policy, verify that the distribution file exists and is accessible.

```
%HSM-E-MANRECOVER, unable to access filename in shelf, manual recovery required
```

## HSM Error Messages

### A.2 Shelf Handler Messages

**Explanation:** A problem was encountered trying to unshelve a file. Please refer to the error log for more details. If the problem cannot be recovered (for example, a deleted online file), use SMU LOCATE/FULL and OpenVMS BACKUP to restore the file from the shelf.

`%HSM-E-NOARCHIVE, no archive classes defined for shelf`

**Explanation:** An attempt to preshelve or shelve a file failed because no archive classes were defined for the appropriate shelf. Use SMU SET SHELF/ARCHIVE to define archive classes to shelve files.

`%HSM-E-NODRIVEAVAIL, no drive available to perform operation`

**Explanation:** An error occurred on any shelve/unshelve operation because no devices were available to perform the operation. Ensure that an SMU device was defined to appropriate archive classes. In Plus Mode, ensure that the SMU device and archive configurations are compatible with the definitions in TAPESTART.COM, and the SMU SHOW DEVICE shows as "Configured". If it shows as "Not Configured", you should re-verify the definitions of archive media type /density and device name to be identical in the SMU and MDMS configurations. This message does not appear if the device is simply busy with other applications.

`%HSM-F-NOLICENSE, license for HSM is not installed`

**Explanation:** You must install an HSM license in order to use this software.

`%HSM-E-NONEXPR, nonexistent process`

**Explanation:** An SMU or policy execution request failed because HSM was not running. Use SMU START to startup HSM and retry the operation.

`%HSM-E-NOSUCHDEV, volumename - no such volume available`

**Explanation:** The policy execution process was unable to assign a channel to the device or get information about the device. Please check that the device is known and available to the system. If the device is no longer in service, it should be removed from the HSM configuration.

`%HSM-E-NOSUCH_FILE, - no such file filename found`

**Explanation:** The policy execution process was unable to locate the distribution list to be used for mail notification or requested a file to be shelved that no longer exists.

`%HSM-E-NOSUCH_REQUEST, - no such request found`

**Explanation:** The /CANCEL qualifier was used to cancel a request that has already been completed by the shelf handler.

`%HSM-E-NORESTARC, no restore archive classes defined for shelf`

**Explanation:** This is a common error meaning that no restore archive classes are defined for the shelf. Use SMU SHOW SHELF to make sure that the archive list and restore archive lists are compatible, and add the restore archive list as needed, using SMU SET SHELF/RESTORE=(list). In most cases, the archive and restore lists should be the same.

`%HSM-I-NOTSHELVED, file filename was not shelved`

**Explanation:** An UNSHELVE/ONLINE request was issued for a file that was not shelved. No action is required.

`%HSM-E-NOUIC_QUOTA, - no quota for user username found`

## HSM Error Messages

### A.2 Shelf Handler Messages

**Explanation:** The policy execution process found no disk quota defined for this user or quotas are not enabled for the disk. The policy execution process will assume that the low-water mark has been reached by default.

`%HSM-E-NOVOLAVAIL, new volume could not be allocated`

**Explanation:** In Basic Mode this means you have exhausted the number of volumes allowed for the archive class; define a new archive class. In Plus Mode, this means that the volume pools(s) specified do not contain enough volumes to allocate a new volume. Either add new volumes to the pool, or define additional pools for the archive class.

`%HSM-E-OCCPOLDIS, - occupancy full policy execution disabled on volume volumename`

**Explanation:** The occupancy full policy has been disabled on this volume. Use SMU SET VOLUME command to enable occupancy full condition handling.

`%HSM-E-OFFLINERROR, off-line system error, function not performed`

**Explanation:** An error occurred trying to read or write to the near-line/off-line system. Refer to the error log for more details, fix the problem, and retry. There are usually additional messages to explain the problem in the error log.

`%HSM-E-OFFREADERR, off-line read error on drive drivename`

**Explanation:** An error occurred trying to read a file on the specified near-line/off-line drive. Refer to the error log for more details, fix the problem, and retry. There are usually additional messages to explain the problem in the error log.

`%HSM-E-OFFWRITERR, off-line write error on drive drivename`

**Explanation:** An error occurred trying to write a file on the specified near-line/off-line drive. Refer to the error log for more details, fix the problem, and retry. There are usually additional messages to explain the problem in the error log.

`%HSM-E-ONLINERROR, unrecoverable online access error`

**Explanation:** HSM was unable to access or read a file, or the disk itself, from the online system. Refer to the error log for more details, fix the problem, and retry. There are usually additional messages to explain the problem in the error log.

`%HSM-E-OPCANCELED, operation canceled`

**Explanation:** On a recovery of the shelf handler process, the operation was canceled because it should not be retried.

`%HSM-E-OPDISABLED, shelving operation disabled`

**Explanation:** The requested operation has been disabled by the storage administrator. Operations can be disabled at the facility, shelf, disk volume and off-line device levels. To re-enable, enter the appropriate SMU SET/ENABLED command. This message also appears after an SMU SHUTDOWN, but before the facility has actually shut down.

`%HSM-E-PEPCOMMERROR, unable to send to policy execution process`

**Explanation:** The shelf handler process could not send a request to the policy execution process. This usually means that the policy execution process has not been started. Issue an SMU STARTUP command to recover.

`%HSM-E-PEPMBX, - communication mailbox mailboxname not enabled`

## HSM Error Messages

### A.2 Shelf Handler Messages

**Explanation:** The policy execution process was unable to establish communications with the shelf handler process, which usually means that the shelf handler process is not running, or create a mailbox for its own use. Issue an SMU STARTUP command to recover.

`%HSM-F-PEP_ALREADY_STARTED, - policy execution process already started`

**Explanation:** The HSM policy execution process has already been started.

`%HSM-E-PEP_INCOMPLETE, - policy execution unable to satisfy request`

**Explanation:** The policy execution was unable to reach the specified lowwater mark. Verify that the file selection criteria is suitable for the selected lowwater mark.

`%HSM-F-POLACCESSFAIL, unable to access policy database`

**Explanation:** The policy execution process was unable to access the policy database. Please check the equivalence name of HSM\$MANAGER and redefine as needed. Also verify that any policy files are accessible.

`%HSM-E-POLDISABLED, policy policyname is disabled`

**Explanation:** On a scheduled policy run, the requested policy is disabled. Either enable it, or cancel the scheduled policy run.

`%HSM-E-POLDEF_NF, - policy definition policyname was not found`

**Explanation:** The policy execution process was unable to locate this policy definition in the policy database. Verify that any policies specified for volumes or scheduled have been defined with SMU SET POLICY.

`%HSM-E-POLEXEFAIL, unable to initiate policy execution`

**Explanation:** The shelf handler process could not send a request to the policy execution process. This usually means that the policy execution process has not been started. Issue an SMU STARTUP command to recover.

`%HSM-E-POLVOLDIS, - policy execution disabled on volume volumename`

**Explanation:** The policy execution process has detected that shelving is currently disabled on this volume. For policy execution to take place on the volume, shelving must be enable. Use the SMU SET VOLUME command to enable shelving for the volume.

`%HSM-S-PRESHELVED, file filename preshelved`

**Explanation:** When the /NOTIFY qualifier is specified, this message is displayed on a successful completion of a preshelve operation. The file data has been copied to the cache or the shelf, but the file is still accessible online.

`%HSM-E-PSHLVERROR, - error preshelving file filename`

**Explanation:** HSM encountered an error preshelving this file during policy execution. This could be caused by such things as the file not being found, possibly deleted prior to the shelving action, or the device containing the file being unavailable. Please check the SHP error log for more information on the failure.

`%HSM-W-PSHLVOPINCOM, preshelving operation incomplete for file filename`

**Explanation:** HSM could not complete the preshelving operation for this file during policy execution. Please check the SHP error log for more information on the failure.

`%HSM-E-QUOPOLDIS, - quota exceeded policy execution disabled on volume volumename`



## HSM Error Messages

### A.2 Shelf Handler Messages

**Explanation:** The policy execution process detected that quota exceeded policy events are currently disabled on this volume. Use SMU SET VOLUME to enable.

```
%HSM-I-RECOVERSHLV, inconsistent state found, file shelved
```

**Explanation:** This message may be issued on recovery of a shelf handler process after finding a file in an inconsistent state. The file has been made into a consistent state by shelving it (it was really already shelved). No action is required.

```
%HSM-I-RECOVERUNSHLV, inconsistent state found, file unshelved
```

**Explanation:** This message may be issued on recovery of a shelf handler process after finding a file in an inconsistent state. The file has been made into a consistent state by unshelving it (it was really already unshelved). No action is required.

```
%HSM-E-REPACKINPRG, cannot checkpoint during repack, please try later
```

**Explanation:** An attempt to checkpoint an archive class while that archive class was being repacked was made. Checkpoint and repack are incompatible operations on an archive class. Please re-enter the checkpoint command after the repack has completed.

```
%HSM-E-RESHELVERR, unable to re-shelve file filename, manual recovery required
```

**Explanation:** An attempt to re-shelve a file to additional archive classes failed for some reason. Please examine the error log. As the result of this, the specified file may remain shelved or be unshelved. Existing shelf copies remain available.

```
%HSM-W-SELECTFAILED, MDMS/SLS error selecting a drive for volume volumename, retrying
```

**Explanation:** In Plus Mode, an error occurred trying to select a drive for an HSM operation. Please read the error log for more details.

```
%HSM-I-SERVER, HSM shelf server enabled on node nodename
```

**Explanation:** This is an informational message indicating that a shelf handler on the specified node is now the shelf server. This message is printed in the audit log and to the OPCOM terminal. If at any time you wish to determine which node is the shelf server, examine the tail of the audit log for the last such message.

```
%HSM-E-SHELFERROR, unrecoverable shelf error, data for filename lost
```

**Explanation:** The file could not be found or accessed in the cache or shelf archive classes. This failure results in the loss of the file data. This is written to the error log.

```
%HSM-E-SHELFINFOLOST, shelf access information unavailable for file filename
```

**Explanation:** There was a problem accessing the ACE and/or catalog information trying to unshelve a file. Please use SMU LOCATE to retrieve the file information, then use BACKUP to retrieve the file.

```
%HSM-S-SHELVED, file filename shelved
```

**Explanation:** With /NOTIFY specified, this message is displayed to the user upon successful completion of an explicit shelve operation. The operation is complete when the file is shelved to the initial shelving location, which can be the cache or directly to the shelf.

```
%HSM-E-SHLVERROR, - error shelving file filename
```

## HSM Error Messages

### A.2 Shelf Handler Messages

**Explanation:** HSM encountered an error shelving this file during policy execution. This could be caused by such things as the file not being found, possibly deleted prior to the shelving action, or the device containing the file being unavailable. Please check the SHP error log for more information on the failure.

`%HSM-W-SHLVOPINCOM, shelving operation incomplete for file filename`

**Explanation:** HSM could not complete the shelving operation for this file during policy execution. Please check the SHP error log for more information on the failure.

`%HSM-I-SHLVPRG, shelving files to free disk space`

**Explanation:** This message occurs if a user request results in a DEVICEFULL or EXDISK-QUOTA error, and the file system is requesting HSM to free space for the request. This message is printed to indicate a possible delay in processing the user request.

`%HSM-S-SHUTDOWN, HSM shelving facility shutdown on node nodename`

**Explanation:** In the audit log, this message shows that HSM was shut down with an SMU SHUTDOWN command. It is not automatically restarted.

`%HSM-E-SPLITMERGSERR, - error during shelf split/merge, catalog not changed`

**Explanation:** HSM encountered an error during shelf split /merge. The catalog was not changed. Please check the SHP error log for more information on the failure.

`%HSM-S-STARTED, shelving facility started on node nodename`

**Explanation:** In the audit log and startup log, this message indicates that the shelf handler process was successfully started. No action is required.

`%HSM-F-STACCESSFAIL, error accessing status log files`

**Explanation:** HSM encountered an error while accessing the log files. This could be caused by a device full condition. Please check the state of the HSM\$LOG device.

`%HSM-E-UNEXPERR, unexpected error on operation`

**Explanation:** This message indicates that the shelf handler experienced an unexpected error condition. Please check the SHP error log for more information about the failure and report this to Compaq. This is not a fatal error condition.

`%HSM-E-UNKNOWN_RESP, response unknown, unable to locate corresponding request`

**Explanation:** The policy execution process has received a response from the shelf handler for a shelve/preshelve request that has already been completed. No action is required.

`%HSM-S-UNPRESHELVED, file filename unpreshelved`

**Explanation:** With /NOTIFY specified, this message is displayed to the user upon successful completion of an unpreshelve operation.

`%HSM-S-UNSHELVED, file filename unshelved`

**Explanation:** With /NOTIFY specified, this message is displayed to the user upon successful completion of an unshelve operation. The file is now online and available for user access.

`%HSM-I-UNSHLVPRG, unshelving file filename`

## HSM Error Messages

### A.2 Shelf Handler Messages

**Explanation:** A file fault is initiated as a result of attempting to read/write/extend/truncate/execute a file that is shelved. This message is printed to indicate a possible delay in processing the user request.

```
%HSM-F-VOLACCESSFAIL, unable to access volume database
```

**Explanation:** The policy execution process was unable to access a volume's policy information from the volume database. Please check the equivalence name of HSM\$MANAGER and redefine as needed. Also verify that the volume file is accessible and that all needed volumes have been defined with SMU SET VOLUME.

```
%HSM-E-VOLDEF_NF, volume definition volumedef was not found
```

**Explanation:** The policy execution process was unable to locate this volume or the default volume definition in the volume database. Please verify that needed volumes have been defined with SMU SET VOLUME. Also, the HSM\$DEFAULT\_VOLUME entry should never be deleted.

```
%HSM-E-VOLNOTLOADED, off-line volume(s) could not be loaded
```

**Explanation:** An error occurred trying to load or mount a specific volume for a shelving operation. Please refer to the error log for more information, fix, and retry.

```
%HSM-E-VOLUME_NF, volume volumename was not found
```

**Explanation:** For a REPACK operation, this tape volume or a member of the volume set containing this volume was not found in the MDMS volume database. In plus mode, all source tape volumes for REPACK must exist in the MDMS volume database.

The following messages are displayed by the utilities that support explicit SHELVE, PRESHELVE and UNSHELVE commands. Although only the SHELVE command messages are listed here, there are similar messages for the PRESHELVE and UNSHELVE commands.

```
%SHELVE-F-BADSEARCH, shelve search confused
```

**Explanation:** This failure message alerts you that the shelving operation got confused while searching for the files specified on the command line. No HSM action took place.

```
%SHELVE-I-ALRSHELVED, file filename was previously shelved
```

**Explanation:** A shelve request was issued for a file that is already shelved. No action is required.

```
%SHELVE-W-CANCELLED, shelving operation on file filename canceled
```

**Explanation:** The shelving request has been canceled due to a specific cancel request, a request that conflicts with another user, or a failure of a multi-operation request. In the last case, please check the SHP error log for more information.

```
%SHELVE-F-CLI, fatal error detected parsing command line
```

**Explanation:** This failure messages alerts you that a fatal error was encountered while parsing the command line. Verify the command syntax, fix and retry.

```
%SHELVE-F-CLI_BY_OWNER, value shelf-value invalid for /BY_OWNER qualifier
```

**Explanation:** This failure message alerts you that you entered an invalid value for the /BY\_OWNER qualifier on the command line. Verify that UIC syntax and that it exists.

```
%SHELVE-F-CLI_INVTIM, invalid absolute time - use DD-MMM- YYYY:HH:SS.CC format
```

## HSM Error Messages

### A.2 Shelf Handler Messages

**Explanation:** This failure message alerts you that you entered an invalid time value on the command line. Verify the time value and make sure it conforms to the DD-MMM-YYYY:HH:SS.CC format (use of TODAY, TOMORROW and YESTERDAY are also valid).

```
%SHELVE-E-DISCLASS, command class has been automatically disabled
```

**Explanation:** A repeated fatal error in the shelf handler has been detected on a certain class of operations. Please refer to the SHP error log for detailed information, and report the problem to Compaq. Since the fatal error continually repeats, HSM disabled the class of operation causing the problem, so that other operations might proceed. After fixing the problem, you can re-enable all operations using SMU SET FACILITY/REENABLE.

```
%SHELVE-W-ERROR, error shelving file filename
```

**Explanation:** This warning message alerts you that an error was encountered while trying to shelve the file. There may be an accompanying error message that gives more information about any failure (privileges, communications failure, etc.). Also check the SHP error log for more information about the failure.

```
%SHELVE-F-FATAL, fatal error condition detected
```

**Explanation:** This failure message alerts you that a fatal error condition was encountered while shelving a file. Please check the SHP error log for more information.

```
%SHELVE-F-FATAL_P, fatal error condition detected
```

**Explanation:** An unexpected error was encountered while parsing/processing a confirmation action. Please see HELP or the reference documentation for valid responses.

```
%SHELVE-F-INCONSIST, internal inconsistency detected
```

**Explanation:** SMU was unable to generate a request for the shelf handler. This could be caused by an insufficient memory condition.

```
%SHELVE-F-INTERNAL, internal error detected, code = value
```

**Explanation:** This failure message alerts you that an internal error condition was detected with a code of value. This could have come from the policy execution process if memory couldn't be allocated, there was a problem queuing a job or getting job information, there was an unexpected error getting system information, etc. There may be more information about the failure in the PEP error log. From SMU, this could mean that an unexpected error was encountered while parsing/processing a confirmation action, getting job or system information, etc.

```
%SHELVE-W-INVALIDANS, text is an invalid answer
```

**Explanation:** The response given to a confirmation action is incorrect. Please see HELP or the reference documentation for valid responses.

```
%SHELVE-W-INVFILESPEC, invalid file specification format
```

**Explanation:** This warning message alerts you that your file specification format is invalid. Please re-enter the command with a valid file specification.

```
%SHELVE-W-INVFORMAT, invalid internal format
```

## HSM Error Messages

### A.2 Shelf Handler Messages

**Explanation:** A request generated by SMU and sent to the shelf handler has an invalid internal format. The request cannot be processed by the shelf handler. There may be more information about the failure in the SHP error log.

`%SHELVE-W-INVREQUEST, invalid shelving request`

**Explanation:** For policy execution, the policy execution process received an unexpected error from the shelf handler for the shelve request. This could include missing archive or shelf definitions or an incorrectly formatted request. SMU may have also encountered these problems or there was a problem communicating with the shelf handler. There may be more information about the failure in the PEP or SHP error logs.

`%SHELVE-S-MARKEDCANCEL, file filename was marked for cancel`

**Explanation:** This status message informs you that your file has been marked for cancellation and won't be shelved.

`%SHELVE-W-NOFILES, no files found`

**Explanation:** SMU was unable to locate the specified files. Reasons include insufficient memory, invalid file specification, file(s) already in requested state, etc. There may be an accompanying message that gives more information about any failure.

`%SHELVE-W-NOMODDATE, modification date not enabled for file`

**Explanation:** Expiration dates are not currently enabled for this file/volume. Expiration dates are needed for the /SINCE and /BEFORE qualifiers.

`%SHELVE-W-NOSUCHDEVICE, no such device found`

**Explanation:** For REPACK, an unload request was sent to the shelf handler for a tape device that is not known. The shelf handler may have encountered an unexpected error trying to read a volume's UID file. The policy execution process may be trying to access a disk volume that is no longer defined. Please check the PEP or SHP error logs for more information.

`%SHELVE-W-NOSUCHFILE, no such file filename found`

**Explanation:** A cache flush shelve request was made for a file that no longer exists. Please see the SHP error log for more information.

`%SHELVE-W-NOSUCHPOLICY, no such policy found`

**Explanation:** This warning message alerts you that the policy you are specifying cannot be found. There may be an accompanying message that gives more information about the failure. Please check the PEP and SHP error logs for more information.

`%SHELVE-W-NOSUCHREQ, no such request found`

**Explanation:** The /CANCEL qualifier was used to cancel a request that has already been completed by the shelf handler.

`%SHELVE-E-NOTSHELVED, file filename was not shelved`

**Explanation:** This error message informs you that the file was not shelved. This could be due to an error during the shelving process, or, for a restore request, the file wasn't shelved. Please see the SHP error log for more information.

`%SHELVE-W-OPINCOM, shelving operation incomplete for file filename`

## HSM Error Messages

### A.2 Shelf Handler Messages

**Explanation:** The shelving operation was unable to complete due to an error. Please see the SHP error log for more information.

`%SHELVE-S-QUEUED, file filename queued for shelving`

**Explanation:** When the /NOWAIT/LOG qualifiers are used, this message indicates that your request has been queued for processing.

`%SHELVE-E-RSPCOMM, response communications error`

**Explanation:** SMU encountered an unexpected error while trying to read a response from the shelf handler. There may be an accompanying message that gives more information about any failure. Please verify that the shelf handler is running and restart as needed with SMU START.

`%SHELVE-F-SEARCHFAIL, error searching for file filename`

**Explanation:** The specified file does not exist. Verify that the filename is correct and that the file exists, then retry the command.

`%SHELVE-S-SHELVED, file filename shelved`

**Explanation:** This status message informs you that your file has been shelved successfully.

`%SHELVE-F-SLFCOMM, shelf handler communications failure`

**Explanation:** This message indicates that the shelf handler is not running. Use SMU START to start the shelf handler and retry.

`%SHELVE-F-SLFMESSAGE, corrupt response message detected`

**Explanation:** The failure message alerts you that a bad response message was received from the shelf handler or an error was encountered while trying to format and display an error message.

`%SHELVE-E-UNKSTATUS, unknown status returned from the shelf handler`

**Explanation:** This error message informs you that the shelf handler process returned an unknown status message. Please report this problem to Compaq and include relevant entries in the error and audit logs.

`%SHELVE-E-UNSUPP, operation unsupported`

**Explanation:** This error message informs you that the operation you are attempting is unsupported by this software. This is usually caused by a node name being included in a file specification.

`%SHELVE-F-USLFCOMM, user communications failure`

**Explanation:** This failure message alerts you that the shelf handler detected a failure in user communications. SMU was either unable to create a mailbox to receive responses from the shelf handler on the user's behalf or get the name of the mailbox. There may be an accompanying message that gives more information about any failure.

## A.3 Shelf Management Utility Messages

The following messages are printed out by the shelf management utility.

```
%SMU-F-ABORTANA, user aborted ANALYZE
```

**Explanation:** SMU ANALYZE was aborted when a ^Z was entered in response to a repair confirmation.

```
%SMU-F-ABORTSCAN, aborted scan for shelved files on disk volume device-name
```

**Explanation:** SMU ANALYZE aborted processing of the device due to an error or ^Z was entered in response to a repair confirmation.

```
%SMU-E-ARCHID_ADDERR, qualifier required on first SET ARCHIVE, archive-id not created
```

**Explanation:** In plus mode, the /MEDIA\_TYPE qualifier is required for the initial creation of the archive class with the SMU SET ARCHIVE command. Subsequent use of the SMU SET ARCHIVE command to modify the archive class does not require the /MEDIA\_TYPE qualifier. Re-enter the command using the qualifier.

```
%SMU-E-ARCHID_DELEERR, error deleting archive-id
```

**Explanation:** For SMU SET ARCHIVE/DELETE, an error was encountered while trying to delete the archive class. There may be an accompanying message that gives more information about any failure.

```
%SMU-E-ARCHID_DISPERR, error displaying archive-id
```

**Explanation:** For SMU SHOW ARCHIVE, an error was encountered while trying to read the archive information. There may be an accompanying message that gives more information about any failure.

```
%SMU-E-ARCHID_INCOMPAT, device is an incompatible media type for this archive class
```

**Explanation:** For SMU SET DEVICE, the media type of the archive class entered is not compatible with the media type of the device. Verify your configuration and re-enter the command with corrections.

```
%SMU-E-ARCHID_MANYPOOL, archive id archive-id has too many pools added, limit is pool-limit
```

**Explanation:** This error message alerts you that you have exceeded the pool limit for the archive. Verify your configuration and possibly remove pools that are no longer needed, then retry the command.

```
%SMU-W-ARCHID_NF, archive class id class-id not found
```

**Explanation:** The archive class id was not found in the archive database or an unexpected error was encountered while trying to read the volume database. There may be an accompanying message that gives more information about the failure. Verify your configuration then retry the command.

```
%SMU-W-ARCHID_POOLNF, archive class id class-id pool pool-id not found, not removed
```

**Explanation:** For SMU SET ARCHIVE/REMOVE\_POOL, a pool was specified which is not in the pool list for the archive class. Verify your configuration then retry the command.

```
%SMU-I-ARCHIVE_DELETED, archive id archive-id deleted
```

## HSM Error Messages

### A.3 Shelf Management Utility Messages

**Explanation:** The archive class was successfully deleted.

`%SMU-W-ARCHIVE_NF, archive class archive-class not found`

**Explanation:** For SMU SET ARCHIVE/DELETE, the archive class was not found in the archive database. Verify your configuration then retry the command.

`%SMU-E-ARCHIVE_READERR, error reading archive definition, archive-id`

**Explanation:** For SMU SET ARCHIVE/DELETE, an unexpected error was encountered while trying to delete the archive class. There may be an accompanying message that gives more information about any failure. Please check the equivalence name of HSM\$MANAGER and redefine as needed. Also verify that the archive file is accessible.

`%SMU-I-ARCHIVE_UPDATED, archive id archive-id updated`

**Explanation:** The archive class was successfully updated.

`%SMU-W-ARCHUPDERR, unable to update archive information, archive-information`

**Explanation:** An error was encountered while trying to modify the archive class information. This could have been directly from a SMU SET ARCHIVE command, or indirectly from a SMU SET DEVICE/ARCHIVE command which may attempt to update the media type for the archive class. There may be an accompanying message that gives more information about any failure. Please check your configuration, the equivalence name of HSM\$MANAGER and redefine as needed. Also verify that the archive file is accessible.

`%SMU-E-BASIC_MODE_ONLY, basic-mode-feature, is a basic mode feature, see SET FACILITY/MODE`

**Explanation:** The use of this qualifier is for Basic mode only.

`%SMU-I-CACHE_CREATED, cache device device-name created`

**Explanation:** The cache device was successfully added.

`%SMU-E-CACHE_DELERR, error deleting cache definition, cache-name`

**Explanation:** A request was made to delete a cache device that does not exist in the database. Verify your configuration and re-enter the command.

`%SMU-I-CACHE_DELETED, cache device device-name deleted`

**Explanation:** The cache device was successfully deleted.

`%SMU-E-CACHE_DISPERR, error displaying cache device, device-name`

**Explanation:** For SMU SHOW CACHE, an error was encountered while trying to read the cache information. There may be an accompanying message that gives more information about any failure.

`%SMU-W-CACHE_NF, cache device device-name was not found`

**Explanation:** For SMU SET CACHE or SMU SHOW CACHE, the specified cache device was not found in the cache database. Verify your configuration and re-enter the command.

`%SMU-E-CACHE_READERR, error reading cache device definition, device-name`



## HSM Error Messages

### A.3 Shelf Management Utility Messages

**Explanation:** An unexpected error was encountered while trying to read the cache data for a delete or display operation. There may be an accompanying message that gives more information about any failure. Please check the equivalence name of HSM\$MANAGER and redefine as needed. Also verify that the cache file is accessible.

`%SMU-I-CACHE_UPDATED, cache device device-name updated`

**Explanation:** The cache device was successfully updated.

`%SMU-E-CACHE_WRITERR, error writing cache device definition, device-name`

**Explanation:** An unexpected error was encountered while adding or modifying a cache device record. There may be an accompanying message that gives more information about any failure. Please check the equivalence name of HSM\$MANAGER and redefine as needed. Also verify that the cache file is accessible.

`%SMU-E-CANT_CHANGE_MODE, cannot set basic mode after shelving in plus mode`

**Explanation:** For SMU SET FACILITY, you cannot set to Basic mode after files have been shelved in Plus mode.

`%SMU-E-CANT_DEDICATE, remote device can't be dedicated`

**Explanation:** For SMU SET DEVICE, the /DEDICATE qualifier is not valid for use with remote devices.

`%SMU-E-CANT_DO_ARCASSOC, cannot action archive class archive- class, due to nonzero reference`

**Explanation:** For SMU SET ARCHIVE, archive classes with shelf and/or device associations cannot be deleted. The archive class must be removed from the shelf and all devices prior to deletion.

`%SMU-E-CANT_DO_ARCUSED, cannot action archive class archive- class, it has been used`

**Explanation:** For SMU SET ARCHIVE, a request was made to either delete an archive class that has been used for shelving or modify certain attributes of an archive class (such as density or media type) that has been used for shelving.

`%SMU-E-CANT_SET_REMOTE, local device cannot be set to remote`

**Explanation:** For SMU SET DEVICE, the /REMOTE qualifier is not valid for use with an existing local device.

`%SMU-E-CAT_CREATERR, error creating catalog catalog-name`

**Explanation:** An error was encountered while trying to create the catalog. There may be an accompanying message that gives more information about any failure. Please check the equivalence name of HSM\$CATALOG and redefine as needed. Also verify that the device and directory are accessible.

`%SMU-E-CAT_SYNTAXERR, catalog file syntax error catalog-name`

**Explanation:** For SMU SET SHELF/CATALOG, a catalog file syntax error was encountered. Verify the format of the catalog filename and retry the command.

`%SMU-F-CATOPENERR, error opening catalog catalog-name`

## HSM Error Messages

### A.3 Shelf Management Utility Messages

**Explanation:** For SMU ANALYZE, an unexpected error was encountered opening the associated catalog for the device. There may be an accompanying message that gives more information about any failure. SMU ANALYZE will stop processing the current device.

`%SMU-F-CATREADER, error reading catalog catalog-name`

**Explanation:** For SMU ANALYZE, the catalog associated with this device was not found or there was an unexpected error reading from the catalog. There may be an accompanying message that gives more information about any failure. SMU ANALYZE will stop processing the current device.

`%SMU-E-CATWRITERR, error encountered writing catalog - no repair`

**Explanation:** For SMU ANALYZE, an unexpected error was encountered while writing the new catalog entry for a repair. There may be an accompanying message that gives more information about any failure. No repair will be made.

`%SMU-E-CON_READERR, error reading configuration definition, configuration-definition`

**Explanation:** An unexpected error was encountered while trying to read the facility information for SMU SET FACILITY, SMU SET SCHEDULE, SMU SHOW SHELF or SMU COPY. There may be an accompanying message that gives more information about any failure. Please check the equivalence name of HSM\$MANAGER and redefine as needed. Also verify that the configuration file is accessible.

`%SMU-W-CONFIG_NF, configuration configuration-name was not found`

**Explanation:** The facility information was not found in the configuration database for SMU SET FACILITY, SMU SET SCHEDULE, SMU SHOW FACILITY or SMU COPY. This error could also mean that the shelf handler was unable to locate the facility information during a shelf update request. There may be an accompanying message that gives more information about any failure. The SMU SET FACILITY command should be used to create the facility data if none exists.

`%SMU-E-COPYCHKERR, error(s) verifying shelf ACE`

**Explanation:** For SMU COPY, an error was encountered during the initial phase that verifies that the shelving ACE on the files to be copied is correct. There may be an accompanying message that gives more information about any failure.

`%SMU-I-COPYCHK, verifying shelving ACE on files to be copied`

**Explanation:** SMU COPY is verifying that the shelving ACE on the files to be copied is correct.

`%SMU-E-COPYDEV, cannot copy to source device, use DCL RENAME instead`

**Explanation:** The SMU COPY command has detected that the source and destination devices are the same. If this is desired, then the DCL RENAME command should be used instead.

`%SMU-E-COPYDST, specify device or device and directory location only`

**Explanation:** The SMU COPY command has detected that the destination specified contains more than a device and/or directory location. Node names are not allowed as are any attempt to specify a file name or portion of one.

`%SMU-I-COPYSTART, starting file copy`

## HSM Error Messages

### A.3 Shelf Management Utility Messages

**Explanation:** SMU COPY has completed all initial verifications and is starting the actual file copy.

`%SMU-F-CREATERR, error creating database, database-name`

**Explanation:** An error was encountered while trying to create a new database file. There may be an accompanying message that gives more information about any failure. Please check the equivalence name HSM\$MANAGER and redefine as needed. Also verify that the device is accessible and has enough free space.

`%SMU-E-DATABASERR, error detected on database, database`

**Explanation:** An unexpected error was encountered while trying to delete a record from this database. There may be an accompanying message that gives more information about any failure.

`%SMU-E-DELERR, error deleting database record, database-record`

**Explanation:** An unexpected error was encountered while trying to delete a record from this database or the record entry does not exist. Other causes could be an attempt to delete a default policy, facility record, default shelf record, a shelf that still has volume (disk) references, a shelf that contains a catalog reference other than the one assigned to the default shelf, a shelf where a split/merge is currently active, default volume record, a volume that contains a shelf reference other than the one assigned to the default volume or a volume where a split/merge is currently active. There may be an accompanying message that gives more information about any failure.

`%SMU-E-DEV_DELERR, error deleting device definition, device- name`

**Explanation:** An attempt was made to delete the default device record or a device that does not exist in the database. There may be an accompanying message that gives more information about any failure. Verify your configuration and retry the command.

`%SMU-E-DEV_DISPERR, error displaying device, device-name`

**Explanation:** For SMU SHOW DEVICE, an error was encountered while trying to read the device information. There may be an accompanying message that gives more information about any failure.

`%SMU-W-DEV_INELIG, device device-name is ineligible`

**Explanation:** An attempt was made to use a device which is not currently available on the system. This could come from SMU SET CACHE to add a new cache device, SMU SET SCHEDULE on one of the listed volumes or SMU SET VOLUME to add a new volume. There may be an accompanying message that gives more information about any failure.

`%SMU-E-DEV_NOTREMOTE, device device is not a remote device specification`

**Explanation:** For SMU SET DEVICE/REMOTE, the device name must contain a node name or the node name must be included in a logical name assignment for the device.

`%SMU-E-DEV_READERR, error reading device definition, device- name`

**Explanation:** For SMU SET DEVICE or SMU SHOW DEVICE, an unexpected error was encountered while trying to delete a device record or read a device record for display. There may be an accompanying message that gives more information about any failure.

`%SMU-E-DEV_WRITERR, error writing device definition, device- name`

## HSM Error Messages

### A.3 Shelf Management Utility Messages

**Explanation:** For SMU SET DEVICE, an attempt was made to add a device where the media type is not compatible with its associated archive class(es), the /DEDICATE qualifier was specified for a remote device, the /REMOTE qualifier was specified for an existing local device or an unexpected error was encountered while writing a new or modified device record. There may be an accompanying message that gives more information about any failure.

`%SMU-I-DEVICE_CREATED, device device-name created`

**Explanation:** The device was successfully created.

`%SMU-I-DEVICE_DELETED, device device-name deleted`

**Explanation:** The device was successfully deleted.

`%SMU-W-DEVICE_NF, device device-name was not found`

**Explanation:** For SMU SET DEVICE or SMU SHOW DEVICE, the device was not found in the device database. For SMU SET SCHEDULE or SMU SHOW SCHEDULE, there was no scheduled event for the volume.

`%SMU-I-DEVICE_UPDATED, device device-name updated`

**Explanation:** The device was successfully updated.

`%SMU-E-DEVINFOERR, error getting device information for device- name`

**Explanation:** For SMU ANALYZE, an unexpected error was encountered getting information about the device. SMU ANALYZE will stop processing this device/set.

`%SMU-E-DISCLASS, command class has been automatically disabled`

**Explanation:** A repeated fatal error in the shelf handler has been detected on a certain class of operations. Please refer to the SHP error log for detailed information, and report the problem to Compaq. Since the fatal error continually repeats, HSM disabled the class of operation causing the problem, so that other operations might proceed. After fixing the problem, you can re-enable all operations using SMU SET FACILITY/REENABLE.

`%SMU-E-DISPLAYERR, display error encountered`

**Explanation:** An error was encountered while trying to display the requested information. There may be an accompanying message that gives more information about any failure.

`%SMU-I-ENDSCAN, completed scan for shelved files on disk volume device-name`

**Explanation:** SMU ANALYZE has completed processing of this device.

`%SMU-E-ENF, job entry not found`

**Explanation:** For SMU SET SCHEDULE or SMU SHOW SCHEDULE, no job entry was found for the listed volume(s) or specific entry number if /ENTRY was used. There may be an accompanying message that gives more information about any failure.

`%SMU-I-ERRORS, number error(s) detected, number error(s) repaired`

**Explanation:** For SMU ANALYZE, this message is for the device indicating the number of errors detected and repaired.

`%SMU-I-FAC_UPDATED, HSM facility modified`

**Explanation:** The facility was successfully modified.

`%SMU-W-FACUPDERR, unable to update facility information`

## HSM Error Messages

### A.3 Shelf Management Utility Messages

**Explanation:** For SMU SET FACILITY, an error was encountered while trying to modify the facility information. There may be an accompanying message that gives more information about the failure. Please check your configuration and the equivalence name of HSM\$MANAGER and redefine as needed. Also verify that the configuration file is accessible.

`%SMU-F-FNF, file not found`

**Explanation:** For SMU SET SCHEDULE, the supplied command procedure to initiate policy execution was not found. There will be an accompanying message that give more information about the failure. The file may have to be restored from a previous backup or the HSM distribution.

`%SMU-W-HSMCOMM, shelf handler communications failure`

**Explanation:** An error was encountered while trying to establish communications with the shelf handler. There may be an accompanying message that give more information about any failure. Verify that the shelf handler is running and startup with SMU START if needed.

`%SMU-W-HSMMESSAGE, corrupt response message detected`

**Explanation:** A message returned from the shelf handler contained too many FAO parameters or an error was encountered formatting the message for display. Please report this problem to Compaq.

`%SMU-F-INDOPENERR, error opening INDEXF.SYS on device-name`

**Explanation:** For SMU ANALYZE, an unexpected error was encountered opening INDEXF.SYS for the device. There may be an accompanying message that gives more information about any failure. SMU ANALYZE will stop processing this device.

`%SMU-F-INITFAILED, fatal error encountered during initialization`

**Explanation:** The shelf management utility failed to initialize.

`%SMU-F-INREADERR, error reading INDEXF.SYS on device-name`

**Explanation:** For SMU ANALYZE, an unexpected error was encountered while reading INDEXF.SYS for the device. There may be an accompanying message that gives more information about any failure. SMU ANALYZE will stop processing this device.

`%SMU-F-INTERNAL, fatal internal error detected, error-string`

**Explanation:** Internal inconsistency detected. There may be an accompanying message that gives more information about any failure. If the problem can't be corrected locally, please report this problem to Compaq.

`%SMU-W-INVALANS, string - is an invalid answer`

**Explanation:** The response given to a confirmation action is incorrect. Please see HELP or the reference documentation for valid responses.

`%SMU-E-INVALARCHIVE, invalid archive- archive-id`

**Explanation:** For SMU SET ARCHIVE, the archive id is outside the range of valid values. Currently, for Basic mode this range is 1 thru 36 and for Plus mode is 1 thru 9999.

`%SMU-W-INVALIDDIR, invalid directory specification, directory- spec`

## HSM Error Messages

### A.3 Shelf Management Utility Messages

**Explanation:** An invalid file specification was given for the /OUTPUT qualifier. Re-enter the command with a valid output location.

```
%SMU-E-INVALIST, exceeded maximum list count of count
```

**Explanation:** Maximum number of parameter list elements were found. There will be an accompanying message indicating which parameter or qualifier is in violation. Please see HELP or the reference documentation for more information about the command.

```
%SMU-E-INVALPSIZE, exceeded maximum parameter size value
```

**Explanation:** A parameter value entered in the command exceeds its valid range or size. The maximum value will be displayed for reference. The accompanying message will indicate what value is in error. Re-enter the command with a corrected value.

```
%SMU-E-INVALQSIZE, invalid qualifier size qualifier-size
```

**Explanation:** A qualifier value entered in the command exceeds its valid range or size. The maximum value will be displayed for reference. The accompanying message will indicate which qualifier is in error either by displaying the qualifier name or the value itself. Re-enter the command with a corrected qualifier value.

```
%SMU-E-INVCONFIG, invalid tape drive configuration for repack request volume-name
```

**Explanation:** For SMU REPACK, there is an invalid tape drive configuration. One possible cause is that there are not enough tape drives; REPACK must use two. A second possibility is that there are no devices associated with the archive classes specified in the command.

```
%SMU-W-INVNAME, invalid volume name volume-name
```

**Explanation:** For SMU RANK, a wildcard character was detected in the volume name parameter. Wildcards are not allowed.

```
%SMU-E-INVPARAM, parameter or value for parameter parameter or parameter-value is invalid
```

**Explanation:** An invalid parameter or parameter value was detected in the command. There will be an accompanying message to indicate which parameter is in violation. Re-enter the command with corrected syntax. Please see HELP or the reference documentation for more information about the command.

```
%SMU-E-INVPOLNAME, invalid policy name policy-name
```

**Explanation:** For SMU RANK or SMU SET SCHEDULE, a wildcard character was detected in the policy name parameter. Wildcards are not allowed. Re-enter the command with the correct syntax. Please see HELP or the reference documentation for more information about the command.

```
%SMU-E-INVQUAL, invalid qualifier or qualifier value qualifier
```

**Explanation:** An invalid qualifier or associated value was detected in the command. There will be an accompanying message to indicate which qualifier is in violation. Re-enter the command with corrected syntax. Please see HELP or the reference documentation for more information about the command.

```
%SMU-W-INVREQUEST, invalid shelf handler request
```

## HSM Error Messages

### A.3 Shelf Management Utility Messages

**Explanation:** The shelf handler has received an invalid request from SMU. There may be more information about the failure in the SHP error log. If this problem cannot be corrected, please report it to Compaq.

`%SMU-E-INVOLNAME, invalid volume name volume-name`

**Explanation:** For SMU SET ARCHIVE/LABEL in Basic mode, the volume name entered does not conform to the Basic mode volume label convention. Please see the documentation for a description of the correct format and re-try the command.

`%SMU-E-JOBEXECUTING, job job executing on server prevents requested operation`

**Explanation:** For SMU SET SCHEDULE, an update request was made for a job that is currently executing. No changes were made. Re-enter the command once the job has completed.

`%SMU-W-LOCATE, error(s) occurred during locate processing`

**Explanation:** For SMU LOCATE, one or more errors occurred during locate processing.

`%SMU-E-LOCKERR, error locking database database-name`

**Explanation:** An unexpected error was encountered while trying to unlock a record in the database. There may be an accompanying message that gives more information about any failure.

`%SMU-E-LOCKTIMEOUT, timed out waiting for SPLIT/MERGE lock`

**Explanation:** A SMU SET VOLUME or SMU SET SHELF command timed out waiting for split/merge lock to become available. Re-try the command later.

`%SMU-E-MEMALLOC, error allocating memory in routine routine`

**Explanation:** An error was encountered while trying to allocate memory. There may be an accompanying message that gives more information about any failure.

`%SMU-E-MUSTUSEREMOTE, device device-name must be created using the /REMOTE qualifier`

**Explanation:** For SMU SET DEVICE, a remote device name was entered, contains a node name, without use of the /REMOTE qualifier. Re-enter the command with the /REMOTE qualifier, or remove the node name from the device specification.

`%SMU-W-NOARCHIVE, archive class(es) not found`

**Explanation:** A database read request sent to the shelf handler on an update failed because the archive class was not found or was outside its valid range.

`%SMU-E-NOCACHELIST, no cache device name or list of devices names`

**Explanation:** For SMU SET CACHE, no cache name or list of names was present in the command. Re-enter the command and specify a cache device or list of devices.

`%SMU-E-NODEFINLIST, the default device may not be in a device list`

**Explanation:** For SMU SET DEVICE, the default device may not be specified in the command. Re-enter the command without using the default device.

`%SMU-E-NODEVICELIST, no device name or list of devices found`

## HSM Error Messages

### A.3 Shelf Management Utility Messages

**Explanation:** For SMU SET DEVICE, no device name or list of names was present in the command. Re-enter the command and specify a device or list of devices.

`%SMU-W-NOENTFND, no database entries found for string`

**Explanation:** An unexpected error was encountered while trying to read from a SMU database. The message will contain the database involved. There may be an accompanying message that gives more information about any failure. Please check the equivalence name of HSM\$MANAGER and redefine as needed. Also verify that the database files are accessible.

`%SMU-E-NOFILEATTR, error reading file attributes for file ID file-id`

**Explanation:** For SMU ANALYZE, an unexpected error was encountered while reading the file attributes. There may be an accompanying message that gives more information about any failure. SMU ANALYZE will stop processing this file.

`%SMU-W-NOFILES, no files found`

**Explanation:** For SMU LOCATE, no files were found that matched the search criteria or the catalog is empty.

`%SMU-E-NONEXIST_SHELF, nonexistent shelf, shelf-name`

**Explanation:** For SMU SET VOLUME/SHELF, a shelf name was given that doesn't exist in the database. Re-enter the command and specify a defined shelf, or define the new shelf and then re-enter the command.

`%SMU-E-NONEXT, no next device found in set after device-name`

**Explanation:** For SMU ANALYZE, an unexpected error was encountered getting information about the next device in the volume set. There may be an accompanying message that gives more information about any failure. SMU ANALYZE will stop processing this device/set.

`%SMU-E-NOPOLSERV, no policy execution servers found`

**Explanation:** For SMU SET SCHEDULE, since the /SERVER qualifier was not used, an attempt was made to select a server from the facility definition. This attempt failed due to errors getting system or cluster information.

`%SMU-E-NOPOLLIST, no policy name or list of policies found`

**Explanation:** For SMU SET POLICY, no policy name or list of names was present in the command. Re-enter the command and specify a policy name or list of policies.

`%SMU-E-NOSHEFLIST, no shelf name or list of shelves found`

**Explanation:** For SMU SET SHELF, no shelf name or list of names was present in the command. Re-enter the command and specify a shelf name or list of shelves. `%SMU-E-NOSUCHENT, no such entry, entry-name`

**Explanation:** For SMU SET SCHEDULE or SMU SHOW SCHEDULE, no job entry was found for the listed volume(s) or specific entry number if /ENTRY was used. There may be an accompanying message that gives more information about any failure.

`%SMU-E-NOSUCHQUE, no such server queue, queue-name`

**Explanation:** For SMU SET SCHEDULE, a request was made to modify or remove a policy job, but the queue was not found on the policy server.

`%SMU-W-NOTSTARTED, process-name process was not started`



## HSM Error Messages

### A.3 Shelf Management Utility Messages

**Explanation:** A startup or shutdown attempt was made from an account with insufficient privileges, or an unexpected error was encountered while starting up the shelf handler process or the policy execution process. There may be an accompanying message that gives more information about any failure.

`%SMU-W-NOTUPDARCH, archive id archive-id-name was not updated, no new attributes`

**Explanation:** For SMU SET ARCHIVE, a negative response was given to the update confirmation, a delete was requested for a non-existent archive class or there was no new data to change.

`%SMU-W-NOTUPDCACHE, cache device device-name was not updated, no new attributes`

**Explanation:** For SMU SET CACHE, no new attributes were defined for the cache. The update was not performed.

`%SMU-W-NOTUPDDEVICE, device device-name was not updated, no new attributes`

**Explanation:** For SMU SET DEVICE, no new attributes were defined for the device. The update was not performed.

`%SMU-W-NOTUPDFAC, facility was not updated, no new attributes`

**Explanation:** For SMU SET FACILITY, no new attributes were defined for the facility. The update was not performed.

`%SMU-W-NOTUPDPOLICY, policy policy-name was not updated, no new attributes`

**Explanation:** For SMU SET POLICY, no new attributes were defined for the policy. The update was not performed.

`%SMU-W-NOTUPDSCHED, scheduled entry entry-name was not updated, no new attributes`

**Explanation:** For SMU SET SCHEDULE, no new attributes were defined for the entry. The update was not performed.

`%SMU-W-NOTUPDSHELF, shelf shelf-name was not updated, no new attributes`

**Explanation:** For SMU SET SHELF, no new attributes were defined for the shelf. The update was not performed.

`%SMU-W-NOTUPDVOLUME, volume volume-name was not updated, no new attributes`

**Explanation:** For SMU SET VOLUME, no new attributes were defined for the volume. The update was not performed.

`%SMU-F-NOUID, no device UIDs found for device device-name %SMU-F-NOUID, no device UIDs found for set device-name`

**Explanation:** For SMU ANALYZE, no valid UIDs were found in the HSM\$UID.SYS file. SMU ANALYZE will stop processing this device/set.

`%SMU-F-NOUIDFILE, HSM$UID.SYS not available for device device-name %SMU-F-NOUIDFILE, HSM$UID.SYS not available for set device-name`

## HSM Error Messages

### A.3 Shelf Management Utility Messages

**Explanation:** For SMU ANALYZE, no HSM\$UID.SYS file was found on the device/set or the file could not be opened. The missing file indicates that shelving has not taken place on the disk. SMU ANALYZE will stop processing this device/set. Or, during a repair, no HSM\$UID.SYS file could be found and the repair is incomplete.

`%SMU-E-NOVOLLIST, no volume name or list of volumes found`

**Explanation:** For SMU SET VOIUME, no volume name or list of names was present in the command. Re-enter the command and specify a volume name or list of volumes.

`%SMU-E-OFLUPDERR, error updating offline information - no repair %SMU-E-OFLUPDERR, error updating offline information - repair incomplete`

**Explanation:** For SMU ANALYZE, an unexpected error was encountered while writing the HSM metadata to the file and either no repair will be made, or a partial repair has been made and a new catalog entry exists. There may be an accompanying message that gives more information about any failure.

`%SMU-F-OPENERR, error opening, storage-entity`

**Explanation:** For any SMU command that uses the /OUTPUT qualifier, there was an error opening the specified output file. For SMU SET SCHEDULE, there was an error opening the policy execution command file. Or, there was an unexpected error opening one of the SMU database files. There may be an accompanying message that gives more information about any failure.

`%SMU-E-OPERCONF, requested operation conflicts with current activity`

**Explanation:** The requested SMU ANALYZE operation is in conflict with an active Split/Merge operation on the device. SMU ANALYZE will stop processing this device or stop the analysis completely depending on when the conflict was detected. Retry the command later.

`%SMU-W-PEP_ALREADYSTARTED, policy execution process already started`

**Explanation:** A SMU START was issued when there was already a policy execution process started. No action is required.

`%SMU-S-PEP_STARTED, policy execution process started process-id`

**Explanation:** The policy execution process has been successfully started.

`%SMU-E-POL_DELERR, error deleting policy definition, policy- name`

**Explanation:** For SMU SET POLICY, a request was made to delete a policy that does not exist in the database. Verify your configuration and re-enter the command.

`%SMU-E-POL_DISPERR, error displaying policy, policy-name`

**Explanation:** For SMU SHOW POLICY, an error was encountered while trying to read the policy information. There may be an accompanying message that gives more information about any failure.

`%SMU-E-POL_READERR, error reading policy definition, policy- name`

## HSM Error Messages

### A.3 Shelf Management Utility Messages

**Explanation:** For SMU SET POLICY/DELETE, SMU SET SHELF or SMU SHOW POLICY, an unexpected error was encountered while trying to read the policy data for a delete or display operation. There may be an accompanying message that gives more information about any failure. Please check the equivalence name of HSM\$MANAGER and redefine as needed. Also verify that the policy file is accessible.

`%SMU-E-POL_WRITERR, error writing policy definition, policy name`

**Explanation:** For SMU SET POLICY, an unexpected error was encountered while adding or modifying a policy. There may be an accompanying message that gives more information about any failure. Please check the equivalence name of HSM\$MANAGER and redefine as needed. Also verify that the policy file is accessible.

`%SMU-I-POLICY_CREATED, policy policy-name created`

**Explanation:** The policy was successfully created.

`%SMU-I-POLICY_DELETED, policy policy-name deleted`

**Explanation:** The policy was successfully deleted.

`%SMU-W-POLICY_NF, policy policy-name was not found`

**Explanation:** For SMU SET POLICY, SMU SET SCHEDULE, SMU SHOW POLICY or SMU RANK, the policy was not found in the policy database. Verify your configuration then retry the command.

`%SMU-I-POLICY_UPDATED, policy policy-name updated`

**Explanation:** The policy was successfully updated.

`%SMU-E-PLUS_MODE_ONLY, feature, is a plus mode feature, see SET FACILITY/MODE`

**Explanation:** For SMU SET ARCHIVE or SMU SET DEVICE, the use of this qualifier is for Plus mode only.

`%SMU-W-PREREQSW, required prerequisite software, Save Set Manager, not found`

**Explanation:** For SMU REPACK, the Save Set Manager software was not found on the system or exists at a version below the minimum that is required. Please check the documentation for this version of HSM and install the appropriate version of Save Set Manager.

`%SMU-I-PROCESSING, processing input device device-name`

**Explanation:** The input device is currently being processed by SMU ANALYZE.

`%SMU-F-READERR, fatal error encountered reading database, database-name`

**Explanation:** An unexpected error was encountered while reading the catalog. There may be an accompanying message that gives more information about any failure. Please check the equivalence name of HSM\$CATALOG and redefine as needed. Also verify that the catalog file is accessible.

`%SMU-E-RDVOLSHLF, error reading volume or shelf data for device-name`

**Explanation:** For SMU ANALYZE, an unexpected error was encountered getting volume or shelf data for the device. There may be an accompanying message that gives more information about any failure. SMU ANALYZE will stop processing this device.

`%SMU-W-RSPCOMM, shelf handler response communications error`

## HSM Error Messages

### A.3 Shelf Management Utility Messages

**Explanation:** When SMU started processing a response from the shelf handler, it discovered that the shelf handler process no longer existed or there was an error reading the response. There may be an accompanying message that gives more information about any failure. Start the shelf handler with SMU START if needed.

```
%SMU-I-SCHED_CREATED, scheduled policy policy-name for volume volume-name was
created on server server-name
```

**Explanation:** The scheduled policy was successfully created.

```
%SMU-I-SCHED_DELETED, scheduled policy policy-name for volume volume-name was
deleted on server server-name
```

**Explanation:** The scheduled policy was successfully deleted.

```
%SMU-E-SCHED_DELEERR, error deleting policy definition policy- name for volume
volume-name
```

**Explanation:** For SMU SET SCHEDULE/DELETE, an error was encountered while trying to delete the scheduled event. There may be an accompanying message that gives more information about any failure.

```
%SMU-W-SCHED_NF, schedule schedule-name for volume volume-name on server
server-name was not found
```

**Explanation:** For SMU SET SCHEDULE, the scheduled event for the volume was not found in the database. There may be an accompanying message that gives more information about any failure. Verify your configuration then retry the command.

```
%SMU-E-SCHED_WRITERR, error writing scheduled definition for volume volume-
name
```

**Explanation:** For SMU SET SCHEDULE/LOG, an unexpected error was encountered while adding a schedule definition for the volume. There may be an accompanying message that gives more information about any failure.

```
%SMU-I-SCHED_UPDATED, scheduled policy policy-name for volume volume-name was
updated on server server-name
```

**Explanation:** The scheduled policy was successfully updated.

```
%SMU-W-SCHEDUPDERR, unable to update schedule information
```

**Explanation:** For SMU SET SCHEDULE, an error was encountered while trying to modify the scheduled policy attributes. There may be an accompanying message that gives more information about any failure.

```
%SMU-I-SHELF_CREATED, shelf shelf-name created
```

**Explanation:** The shelf was successfully created.

```
%SMU-E-SHELF_DELEERR, error deleting shelf definition, shelf- name
```

**Explanation:** For SMU SET SHELF/DELETE, a request was made to delete a shelf that does not exist in the database. Verify your configuration and re-enter the command.

```
%SMU-I-SHELF_DELETED, shelf shelf-name deleted
```

**Explanation:** The shelf was successfully deleted.

```
%SMU-E-SHELF_DISPERR, error displaying shelf configuration, shelf-name
```

## HSM Error Messages

### A.3 Shelf Management Utility Messages

**Explanation:** For SMU SHOW SHELF, an error was encountered while trying to read the shelf information from the configuration database. There may be an accompanying message that gives more information about any failure. Please check the equivalence name of HSM\$MANAGER and redefine as needed. Also verify that the configuration file is accessible.

```
%SMU-W-SHELF_NF, shelf shelf-name was not found
```

**Explanation:** For SMU SET SHELF or SMU SHOW SHELF, the shelf was not found in the configuration database. Verify your configuration then retry the command.

```
%SMU-E-SHELF_READERR, error reading shelf definition, shelf- name
```

**Explanation:** For SMU SET SHELF or SMU SET VOLUME, an error was detected while trying to read the shelf information from the configuration database. There may be an accompanying message that gives more information about any failure. Please check the equivalence name of HSM\$MANAGER and redefine as needed. Also verify that the configuration file is accessible.

```
%SMU-E-SHELF_REFERR, shelf is referenced by one or more volumes
```

**Explanation:** For SMU SET SHELF, an attempt was made to delete a shelf that has volume references. Use SMU SET VOLUME to change the shelf assignment and retry the command.

```
%SMU-E-SHELF_SMIP, shelf split/merge is in process on shelf shelf-name
```

**Explanation:** For SMU SET SHELF, a delete was requested while a split/merge is in progress on either the current shelf or the default shelf. For SMU SET VOLUME/SHELF, an update request was made to use a shelf where a split/merge is in progress or the split/merge is in progress on the shelf assigned to the default volume. Retry the command later.

```
%SMU-I-SHELF_UPDATED, shelf shelf-name updated
```

**Explanation:** The shelf was successfully updated.

```
%SMU-E-SHELF_WRITERR, error writing shelf definition, shelf- definition-name
```

**Explanation:** For SMU SET SHELF, an error was encountered while trying to access the split/merge lock or an unexpected error was encountered while trying to add or update a shelf definition. There may be an accompanying message that gives more information about any failure. Please check the equivalence name of HSM\$MANAGER and redefine as needed. Also verify that the configuration file is accessible.

```
%SMU-W-SHELFUPDERR, shelf handler process was unable to update information
```

**Explanation:** This is a generic companion message that is displayed when an error is returned from the shelf handler. The accompanying message will give more information about the failure.

```
%SMU-W-SHP_ALREADYSTARTED, shelf handler already started
```

**Explanation:** A SMU START was issued when there was already a shelf handler process started. No action is required.

```
%SMU-S-SHP_STARTED, shelf handler process started process-id
```

**Explanation:** The shelf handler process has been successfully started.

```
%SMU-E-SHUTERR, error shutting down database database-name
```

## HSM Error Messages

### A.3 Shelf Management Utility Messages

**Explanation:** For SMUEXIT, an error was encountered while trying to close the database. There may be an accompanying message that gives more information about any failure. Please check the equivalence name of HSM\$MANAGER and redefine as needed. Also verify that the database file is accessible.

`%SMU-F-SMLOCKERR, error locking SPLIT/MERGE lock`

**Explanation:** For SMU SET SHELF or SMU SET VOLUME, an unexpected error was encountered while trying to acquire the split/merge lock.

`%SMU-F-SNF, policy execution server not found`

**Explanation:** For SMU SET SCHEDULE, the queue was not found on the policy server. There will be accompanying messages that give more information about the queue involved and the failure. Verify that the queue exists.

`%SMU-I-STARTSCAN, scanning for shelved files on disk volume device-name`

**Explanation:** SMU ANALYZE is currently processing the device.

`%SMU-W-STARTQ, error encountered attempting to start HSM batch queue`

**Explanation:** During startup, an error was encountered while trying to start the policy execution queue on this node. There may be an accompanying message that gives more information about any failure.

`%SMU-W-UHSMCOMM, user communications failure`

**Explanation:** An error was encountered while trying to establish a response mailbox for the request. There may be accompanying messages that give more information about any failure. It is possible that the request was successfully sent to the shelf handler and will execute.

`%SMU-E-UNDEL_CATREF, catalog referenced by shelf must match HSM$DEFAULT_SHELF`

**Explanation:** For SMU SET SHELF/DELETE, the delete cannot take place until the catalog for the shelf is changed to be the same as the one assigned to HSM\$DEFAULT\_SHELF. Use SMU SET SHELF to change the catalog and retry the command.

`%SMU-E-UNDEL_DEFPOL, default policy definition cannot be deleted`

**Explanation:** For SMU SET POLICY/DELETE, an attempt was made to delete one of the default policies. Retry the command without specifying the default policy.

`%SMU-E-UNDEL_DEFSHELF, default shelf definition cannot be deleted`

**Explanation:** For SMU SET SHELF/DELETE, an attempt was made to delete the default shelf. Retry the command without specifying the default shelf.

`%SMU-E-UNDEL_DEFVOL, default volume definition cannot be deleted`

**Explanation:** For SMU SET VOLUME/DELETE, an attempt was made to delete the default volume. Retry the command without specifying the default volume.

`%SMU-E-UNDEL_SHELFREF, shelf referenced by volume must match HSM$DEFAULT_VOLUME`

**Explanation:** For SMU SET VOLUME/DELETE, the delete cannot take place until the shelf for the volume is changed to be the same as the one assigned to HSM\$DEFAULT\_VOLUME. Use SMU SET VOLUME to change the shelf and retry the command.

`%SMU-F-UPDATERR, fatal error encountered updating database, database-name`

## HSM Error Messages

### A.3 Shelf Management Utility Messages

**Explanation:** An unexpected error was encountered while updating one of the SMU database files or the catalog. There may be an accompanying message that gives more information about any failure. Please check the equivalence names of HSM\$MANAGER and HSM\$CATALOG and redefine as needed. Also verify that the catalog and database files are accessible.

`%SMU-W-UNKSTATUS, shelf handler returned unknown status`

**Explanation:** The shelf handler process returned an unknown status for the request. There may be more information in the SHP error log.

`%SMU-E-VOL_DELERR, error deleting volume definition, volume- name`

**Explanation:** For SMU SET VOLUME/DELETE, a request was made to delete a volume that does not exist in the database. Verify your configuration and re-enter the command.

`%SMU-E-VOL_DISPERR, error displaying volume, volume-name`

**Explanation:** For SMU SHOW VOLUME, an error was encountered while trying to read the volume information from the database. There may be an accompanying message that gives more information about any failure. Please check the equivalence name of HSM\$MANAGER and redefine as needed. Also verify that the volume file is accessible.

`%SMU-E-VOL_NOTUPDATED, volume definition volume-name was not updated`

**Explanation:** For SMU SET VOLUME, this is a general message indicating that the update was not performed. This is usually because the specified shelf doesn't exist, or a split/merge was in progress. There may be an accompanying message that gives more information about any failure. Please check the equivalence name of HSM\$MANAGER and redefine as needed. Also verify that the volume file is accessible.

`%SMU-E-VOL_READERR, error reading volume definition, volume- name`

**Explanation:** An error was encountered while trying to read the volume information for SMU SET VOLUME, SMU SHOW VOLUME or SMU LOCATE. There may be an accompanying message that gives more information about any failure. Please check the equivalence name of HSM\$MANAGER and redefine as needed. Also verify that the volume file is accessible.

`%SMU-E-VOL_SMIP, volume split/merge in progress on volume volume-name`

**Explanation:** For SMU SET VOLUME/DELETE, a delete was requested on a volume while a split/merge is in progress on this volume or the default volume. Retry the command later.

`%SMU-E-VOL_WRITERR, error writing volume definition, volume- definition`

**Explanation:** For SMU SET VOLUME, an error was encountered while trying to access the split/merge lock or an unexpected error was encountered while trying to add or update a volume definition. There may be an accompanying message that gives more information about any failure. Please check the equivalence name of HSM\$MANAGER and redefine as needed. Also verify that the volume file is accessible.

`%SMU-I-VOLUME_CREATED, volume volume-name created`

**Explanation:** The volume was successfully created.

`%SMU-I-VOLUME_DELETED, volume volume-name deleted`

## HSM Error Messages

### A.3 Shelf Management Utility Messages

**Explanation:** The volume was successfully deleted.

%SMU-W-VOLUME\_NF, volume volume-name was not found

**Explanation:** For SMU SET SCHEDULE or SMU RANK, there was an error getting information about the online volume. For SMU SET VOLUME/DELETE or SMU SHOW VOLUME, a request we made for a volume that was not found in the volume database. There may be an accompanying message that gives more information about any failure. Verify that the online volumes exist and are available. Check your configuration and retry the command.

%SMU-I-VOLUME\_UPDATED, volume volume-name updated

**Explanation:** The volume was successfully updated.

%SMU-F-WRITERR, fatal error encountered writing database, database-name

**Explanation:** An unexpected error was encountered while adding an entry to one of the SMU database files or the catalog. There may be an accompanying message that gives more information about any failure. Please check the equivalence names of HSM\$MANAGER and HSM\$CATALOG and redefine as needed. Also verify that the catalog and database files are accessible.



---

## Sample Configuration of MDMS

This appendix shows a sample configuration of Media, Device Management Services (MDMS) including examples for the steps involved.

### B.1 Configuration Order

Configuration - which involves the creation or definition of MDMS objects, should take place in the following order:

1. Location
2. Media type
3. Node
4. Jukebox
5. Drives
6. Pools
7. Volumes

Creating these objects in the above order ensures that the following informational message, does not appear:

```
%MDMS-I-UNDEFINEDREFS, object contains undefined referenced objects
```

This message appears if an attribute of the object is not defined in the database. The object is created even though the attribute is not defined. The sample configuration consists of the following:

- Four nodes

```
SMITH1 - ACCOUN cluster node  
SMITH2 - ACCOUN cluster node  
SMITH3 - ACCOUN cluster node  
JONES - a client node
```

- TL826 Jukebox with robot \$1\$DUA560 and the following six drives:

```
$1$MUA560  
$1$MUA561  
$1$MUA562  
$1$MUA563  
$1$MUA564  
$1$MUA565
```

## Sample Configuration of MDMS

### B.1 Configuration Order

The following examples illustrate each step in the order of configuration.

#### B.1.1 Configuration Step 1 Example - Defining Locations

This example lists the MDMS commands to define an offsite and onsite location for this domain.

```
$ !
$ ! create onsite location
$ !
$ MDMS CREATE LOCATION BLD1_COMPUTER_ROOM -
  /DESCRIPTION="Building 1 Computer Room"
$ MDMS SHOW LOCATION BLD1_COMPUTER_ROOM
  Location: BLD1_COMPUTER_ROOM
  Description: Building 1 Computer Room
  Spaces:
  In Location:
$ !
$ ! create offsite location
$ !
$ MDMS CREATE LOCATION ANDYS_STORAGE -
  /DESCRIPTION="Andy's Offsite Storage, corner of 5th and Main"
$ MDMS SHOW LOCATION ANDYS_STORAGE
  Location: ANDYS_STORAGE
  Description: Andy's Offsite Storage, corner of 5th and Main
  Spaces:
  In Location:
```

#### B.1.2 Configuration Step 2 Example - Defining Media Type

This example shows the MDMS command to define the media type used in the TL826.

```
!
$ ! create the media type
$ !
$ MDMS CREATE MEDIA_TYPE TK88K -
  /DESCRIPTION="Media type for volumes in TL826 with TK88 drives" -
  /COMPACTION ! volumes are written in compaction mode
$ MDMS SHOW MEDIA_TYPE TK88K
  Media type: TK88K
  Description: Media type for volumes in TL826 with TK88 drives
  Density:
  Compaction: YES
  Capacity: 0
  Length: 0
```

#### B.1.3 Configuration Step 3 Example - Defining Domain Attributes

This example shows the MDMS command to set the domain attributes. The reason this command is not run until after the locations and media type are defined, is because they are default attributes for the domain object. Note that the deallocation state (transition) is taken as the default. All of the rights are taken as default also.

```
$ !
$ ! set up defaults in the domain record
$ !
$ MDMS SET DOMAIN -
  /DESCRIPTION="Smiths Accounting Domain" - ! domain name
  /MEDIA_TYPE=TK88K - ! default media type
  /OFFSITE_LOCATION=ANDYS_STORAGE - ! default offsite location
  /ONSITE_LOCATION=BLD1_COMPUTER_ROOM - ! default onsite location
  /PROTECTION=(S:RW,O:RW,G:RW,W) ! default protection for volumes
$ MDMS SHOW DOMAIN/FULL
  Description: Smiths Accounting Domain
```

## Sample Configuration of MDMS B.1 Configuration Order

```
Mail: SYSTEM
Offsite Location: ANDYS_STORAGE
Onsite Location: BLD1_COMPUTER_ROOM
Def. Media Type: TK88K
Deallocate State: TRANSITION
  Opcom Class: TAPES
  Priority: 1536
  Request ID: 2576
  Protection: S:RW,O:RW,G:RW,W
DB Server Node: SPIELN
DB Server Date: 08-Apr-2002 08:18:20
Max Scratch Time: NONE
  Scratch Time: 365 00:00:00
Transition Time: 14 00:00:00
Network Timeout: 0 00:02:00
  ABS Rights: NO
  SYSPRIV Rights: YES
Application Rights: MDMS_ASSIST
                   MDMS_LOAD_SCRATCH
                   MDMS_ALLOCATE_OWN
                   MDMS_ALLOCATE_POOL
                   MDMS_BIND_OWN
                   MDMS_CANCEL_OWN
                   MDMS_CREATE_POOL
                   MDMS_DEALLOCATE_OWN
                   MDMS_DELETE_POOL
                   MDMS_LOAD_OWN
                   MDMS_MOVE_OWN
                   MDMS_SET_OWN
                   MDMS_SHOW_OWN
                   MDMS_SHOW_POOL
                   MDMS_UNBIND_OWN
                   MDMS_UNLOAD_OWN
Default Rights:
Operator Rights: MDMS_ALLOCATE_ALL
                MDMS_ASSIST
                MDMS_BIND_ALL
                MDMS_CANCEL_ALL
                MDMS_DEALLOCATE_ALL
                MDMS_INITIALIZE_ALL
                MDMS_INVENTORY_ALL
                MDMS_LOAD_ALL
                MDMS_MOVE_ALL
                MDMS_SHOW_ALL
                MDMS_SHOW_RIGHTS
                MDMS_UNBIND_ALL
                MDMS_UNLOAD_ALL
                MDMS_CREATE_POOL
                MDMS_DELETE_POOL
                MDMS_SET_OWN
                MDMS_SET_POOL
User Rights: MDMS_ASSIST
            MDMS_ALLOCATE_OWN
            MDMS_ALLOCATE_POOL
            MDMS_BIND_OWN
            MDMS_CANCEL_OWN
            MDMS_DEALLOCATE_OWN
            MDMS_LOAD_OWN
            MDMS_SHOW_OWN
            MDMS_SHOW_POOL
            MDMS_UNBIND_OWN
            MDMS_UNLOAD_OWN
```

## Sample Configuration of MDMS

### B.1 Configuration Order

#### B.1.4 Configuration Step 4 Example - Defining MDMS Database Nodes

This example shows the MDMS commands for defining the three MDMS database nodes of the cluster ACCOUN. This cluster is configured to use DECnet-PLUS.

Note that a node is defined using the DECnet node name as the name of the node.

- If the node has DECnet-PLUS installed, the DECnet Fullname attribute must be the DECnet-PLUS full name.
- If the node uses TCP/IP, the TCP/IP attribute should be defined.
- If you use the GUI, you must define the TCP/IP attribute and include TCPIP in the Transports attribute.

```
$ !
$ !   create nodes
$ !   database node
$ MDMS CREATE NODE SMITH1 -           ! DECnet node name
/DESCRIPTION="ALPHA node on cluster ACCOUN" -
/DATABASE_SERVER -                   ! this node is a database server
/DECNET_FULLNAME=SMI:.BLD.SMITH1 -    ! DECnet-Plus name
/LOCATION=BLD1_COMPUTER_ROOM -
/TCPIP_FULLNAME=SMITH1.SMI.BLD.COM - ! TCP/IP name
$ MDMS SHOW NODE SMITH1
      Node: SMITH1
      Description: ALPHA node on cluster ACCOUN
      DECnet Fullname: SMI:.BLD.SMITH1
      TCP/IP Fullname: SMITH1.SMI.BLD.COM:2501-2510
      Disabled: NO
      Database Server: YES
      Location: BLD1_COMPUTER_ROOM
      Opcom Classes: TAPES
      Transports: DECNET,TCPIP
$ MDMS CREATE NODE SMITH2 -           ! DECnet node name
/DESCRIPTION="ALPHA node on cluster ACCOUN" -
/DATABASE_SERVER -                   ! this node is a database server
/DECNET_FULLNAME=SMI:.BLD.SMITH2 -    ! DECnet-Plus name
/LOCATION=BLD1_COMPUTER_ROOM -
/TCPIP_FULLNAME=SMITH2.SMI.BLD.COM - ! TCP/IP name
/TRANSPORT=(DECNET,TCPIP)           ! TCPIP used by JAVA GUI and JONES
$ MDMS SHOW NODE SMITH2
      Node: SMITH2
      Description: ALPHA node on cluster ACCOUN
      DECnet Fullname: SMI:.BLD.SMITH2
      TCP/IP Fullname: SMITH2.SMI.BLD.COM:2501-2510
      Disabled: NO
      Database Server: YES
      Location: BLD1_COMPUTER_ROOM
      Opcom Classes: TAPES
      Transports: DECNET,TCPIP
$ MDMS CREATE NODE SMITH3 -           ! DECnet node name
/DESCRIPTION="VAX node on cluster ACCOUN" -
/DATABASE_SERVER -                   ! this node is a database server
/DECNET_FULLNAME=SMI:.BLD.SMITH3 -    ! DECnet-Plus name
/LOCATION=BLD1_COMPUTER_ROOM -
/TCPIP_FULLNAME=CROP.SMI.BLD.COM -    ! TCP/IP name
/TRANSPORT=(DECNET,TCPIP)           ! TCPIP used by JAVA GUI and JONES
$ MDMS SHOW NODE SMITH3
      Node: SMITH3
      Description: VAX node on cluster ACCOUN
      DECnet Fullname: SMI:.BLD.SMITH3
      TCP/IP Fullname: CROP.SMI.BLD.COM:2501-2510
      Disabled: NO
      Database Server: YES
      Location: BLD1_COMPUTER_ROOM
      Opcom Classes: TAPES
      Transports: DECNET,TCPIP
```

### B.1.5 Configuration Step 5 Example - Defining a Client Node

This example shows the MDMS command for creating a client node. TCP/IP is the only transport on this node.

```
$ !
$ !   client node
$ !   only has TCP/IP
$ MDMS CREATE NODE JONES -
  /DESCRIPTION="ALPHA client node, standalone" -
  /NODATABASE_SERVER -           ! not a database server
  /LOCATION=BLD1_COMPUTER_ROOM -
  /TCP_IP_FULLNAME=JONES.SMI.BLD.COM - ! TCP/IP name
  /TRANSPORT=(TCP_IP)           ! TCP_IP is used by JAVA GUI
$ MDMS SHOW NODE JONES
      Node: JONES
      Description: ALPHA client node, standalone
DECnet Fullname:
TCP/IP Fullname: JONES.SMI.BLD.COM:2501-2510
      Disabled: NO
Database Server: NO
      Location: BLD1_COMPUTER_ROOM
      Opcom Classes: TAPES
      Transports: TCP_IP
```

### B.1.6 Configuration Step 6 Example - Creating a Jukebox

This example shows the MDMS command for creating a jukebox

```
$ !
$ !   create jukebox
$ !
$ MDMS CREATE JUKEBOX TL826_JUKE -
  /DESCRIPTION="TL826 Jukebox in Building 1" -
  /ACCESS=ALL -                 ! local + remote for JONES
  /AUTOMATIC_REPLY -           ! MDMS automatically replies to OPCOM requests
  /CONTROL=MRD -               ! controlled by MRD robot control
  /NODES=(SMITH1,SMITH2,SMITH3) - ! nodes the can control the robot
  /ROBOT=$1$DUA560 -           ! the robot device
  /SLOT_COUNT=176              ! 176 slots in the library
$ MDMS SHOW JUKEBOX TL826_JUKE
      Jukebox: TL826_JUKE
      Description: TL826 Jukebox in Building 1
      Nodes: SMITH1,SMITH2,SMITH3
      Groups:
      Location: BLD1_COMPUTER_ROOM
      Disabled: NO
      Shared: NO
      Auto Reply: YES
      Access: ALL
      State: AVAILABLE
      Control: MRD
      Robot: $1$DUA560
      Slot Count: 176
      Usage: NOMAGAZINE
```

## Sample Configuration of MDMS

### B.1 Configuration Order

#### B.1.7 Configuration Step 7 Example - Defining a Drive

This example shows the MDMS commands for creating the six drives for the jukebox. This example is a command procedure that uses a counter to create the six drives. In this example it is easy to do this because of the drive name and device name. You may want to have the drive name the same as the device name. For example:

```
$ MDMS CREATE DRIVE $1$MUA560/DEVICE=$1$MUA560
```

This works fine if you do not have two devices in your domain with the same name.

```
$ COUNT = COUNT + 1
$ IF COUNT .LT. 6 THEN GOTO DRIVE_LOOP
$DRIVE_LOOP:
$ MDMS CREATE DRIVE TL826_D1 -
  /DESCRIPTION="Drive 1 in the TL826 JUKEBOX" -
  /ACCESS=ALL - ! local + remote for JONES
  /AUTOMATIC_REPLY - ! MDMS automatically replies to OPCOM requests
  /DEVICE=$1$MUA561 - ! physical device
  /DRIVE_NUMBER=1 - ! the drive number according to the robot
  /JUKEBOX=TL826_JUKE - ! jukebox the drives are in
  /MEDIA_TYPE=TK88K - ! media type to allocate drive and volume for
  /NODES=(SMITH1,SMITH2,SMITH3)! nodes that have access to drive
$ MDMS SHOW DRIVE TL826_D1
  Drive: TL826_D1
  Description: Drive 1 in the TL826 JUKEBOX
  Device: $1$MUA561
  Nodes: SMITH1,SMITH2,SMITH3
  Groups:
  Volume:
  Disabled: NO
  Shared: NO
  Available: NO
  State: EMPTY
  Stacker: NO
  Automatic Reply: YES
  RW Media Types: TK88K
  RO Media Types:
  Access: ALL
  Jukebox: TL826_JUKE
  Drive Number: 1
  Allocated: NO
  :
  :
  :
$ MDMS CREATE DRIVE TL826_D5 -
  /DESCRIPTION="Drive 5 in the TL826 JUKEBOX" -
  /ACCESS=ALL - ! local + remote for JONES
  /AUTOMATIC_REPLY - ! MDMS automatically replies to OPCOM requests
  /DEVICE=$1$MUA565 - ! physical device
  /DRIVE_NUMBER=5 - ! the drive number according to the robot
  /JUKEBOX=TL826_JUKE - ! jukebox the drives are in
  /MEDIA_TYPE=TK88K - ! media type to allocate drive and volume for
  /NODES=(SMITH1,SMITH2,SMITH3)! nodes that have access to drive
$ MDMS SHOW DRIVE TL826_D5
  Drive: TL826_D5
  Description: Drive 5 in the TL826 JUKEBOX
  Device: $1$MUA565
  Nodes: SMITH1,SMITH2,SMITH3
  Groups:
  Volume:
  Disabled: NO
  Shared: NO
  Available: NO
  State: EMPTY
  Stacker: NO
  Automatic Reply: YES
  RW Media Types: TK88K
```

## Sample Configuration of MDMS B.1 Configuration Order

```
RO Media Types:
    Access: ALL
    Jukebox: TL826_JUKE
    Drive Number: 5
    Allocated: NO
$ COUNT = COUNT + 1
$ IF COUNT .LT. 6 THEN GOTO DRIVE_LOOP
```

### B.1.8 Configuration Step 8 Example - Defining Pools

This example shows the MDMS commands to define two pools: ABS and HSM. The pools need to have the authorized users defined.

```
$ !
$ ! create pools
$ !
$ mdms del pool abs
$ MDMS CREATE POOL ABS -
  /DESCRIPTION="Pool for ABS" -
  /AUTHORIZED=(SMITH1::ABS,SMITH2::ABS,SMITH3::ABS,JONES::ABS)
$ MDMS SHOW POOL ABS
  Pool: ABS
  Description: Pool for ABS
Authorized Users: SMITH1::ABS,SMITH2::ABS,SMITH3::ABS,JONES::ABS
Default Users:
$ mdms del pool hsm
$ MDMS CREATE POOL HSM -
  /DESCRIPTION="Pool for HSM" -
  /AUTHORIZED=(SMITH1::HSM,SMITH2::HSM,SMITH3::HSM)
$ MDMS SHOW POOL HSM
  Pool: HSM
  Description: Pool for HSM
Authorized Users: SMITH1::HSM,SMITH2::HSM,SMITH3::HSM
Default Users:
```

### B.1.9 Configuration Step 9 Example - Defining Volumes using the /VISION qualifier

This example shows the MDMS commands to define the 176 volumes in the TL826 using the /VISION qualifier. The volumes have the BARCODES on them and have been placed in the jukebox. Notice that the volumes are created in the UNINITIALIZED state. The last command in the example initializes the volumes and changes the state to FREE.

```
$ !
$ ! create volumes
$ !
$ ! create 120 volumeS for ABS
$ ! the media type, offsite location, and onsite location
$ ! values are taken from the DOMAIN object
$ !
$ MDMS CREATE VOLUME -
  /DESCRIPTION="Volumes for ABS" -
  /JUKEBOX=TL826_JUKE -
  /POOL=ABS -
  /SLOTS=(0-119) -
  /VISION
$ MDMS SHOW VOLUME BEB000
  Volume: BEB000
  Description: Volumes for ABS
  Placement: ONSITE BLD1_COMPUTER_ROOM
  Media Types: TK88K
  Pool: ABS
  Error Count: 0
  Mount Count: 0
  Username:
  Owner UIC: NONE
  Account:
  Job Name:
```

# Sample Configuration of MDMS

## B.1 Configuration Order

```

State: UNINITIALIZED
Avail State: UNINITIALIZED
Previous Vol:
Next Vol:
Format: NONE
Protection: S:RW,O:RW,G:RW,W
Purchase: 08-Apr-2002 08:19:00
Creation: 08-Apr-2002 08:19:00
Init: 08-Apr-2002 08:19:00
Allocation: NONE
Scratch: NONE
Deallocation: NONE
Trans Time: 14 00:00:00
Freed: NONE
Last Access: NONE

$ !
$ ! create 56 volumes for HSM
$ !
$ MDMS CREATE VOLUME -
  /DESCRIPTION="Volumes for HSM" -
  /JUKEBOX=TL826_JUKE -
  /POOL=HSM -
  /SLOTS=(120-175) -
  /VISION
$ MDMS SHOW VOL BEB120
Volume: BEB120
Description: Volumes for HSM
Placement: ONSITE BLD1_COMPUTER_ROOM
Media Types: TK88K
Pool: HSM
Error Count: 0
Mount Count: 0
State: UNINITIALIZED
Avail State: UNINITIALIZED
Previous Vol:
Next Vol:
Format: NONE
Protection: S:RW,O:RW,G:RW,W
Purchase: 08-Apr-2002 08:22:16
Creation: 08-Apr-2002 08:22:16
Init: 08-Apr-2002 08:22:16
Allocation: NONE
Scratch: NONE
Deallocation: NONE
Trans Time: 14 00:00:00
Freed: NONE
Last Access: NONE

$ !
$ ! initialize all of the volumes
$ !
$ MDMS INITIALIZE VOLUME -
  /JUKEBOX=TL826_JUKE -
  /SLOTS=(0-175)
$ MDMS SHOW VOL BEB000
Volume: BEB000
Description: Volumes for ABS
Placement: ONSITE BLD1_COMPUTER_ROOM
Media Types: TK88K
Pool: ABS
Error Count: 0
Mount Count: 0
State: FREE
Avail State: FREE
Previous Vol:
Next Vol:
Format: NONE
Protection: S:RW,O:RW,G:RW,W
Purchase: 08-Apr-2002 08:19:00
Creation: 08-Apr-2002 08:19:00
Init: 08-Apr-2002 08:19:00
Allocation: NONE
Scratch: NONE

Magazine:
Jukebox: TL826_JUKE
Slot: 0
Drive:
Offsite Loc: ANDYS_STORAGE
Offsite Date: NONE
Onsite Loc: BLD1_COMPUTER_ROOM
Space:
Onsite Date: NONE
Brand:
Last Cleaned: 08-Apr-2002 08:19:00
Times Cleaned: 0
Rec Length: 0
Block Factor: 0

Username:
Owner UIC: NONE
Account:
Job Name:
Magazine:
Jukebox: TL826_JUKE
Slot: 120
Drive:
Offsite Loc: ANDYS_STORAGE
Offsite Date: NONE
Onsite Loc: BLD1_COMPUTER_ROOM
Space:
Onsite Date: NONE
Brand:
Last Cleaned: 08-Apr-2002 08:22:16
Times Cleaned: 0
Rec Length: 0
Block Factor: 0

Username:
Owner UIC: NONE
Account:
Job Name:
Magazine:
Jukebox: TL826_JUKE
Slot: 0
Drive:
Offsite Loc: ANDYS_STORAGE
Offsite Date: NONE
Onsite Loc: BLD1_COMPUTER_ROOM
Space:
Onsite Date: NONE
Brand:
Last Cleaned: 08-Apr-2002 08:19:00

```



**Sample Configuration of MDMS  
B.1 Configuration Order**

Deallocation: NONE  
Trans Time: 14 00:00:00  
Freed: NONE  
Last Access: NONE

Times Cleaned: 0  
Rec Length: 0  
Block Factor: 0



---

## MDMS Messages

### **ABORT**

request aborted by operator

**Explanation:** The request issued an OPCOM message that has been aborted by an operator. This message can also occur if no terminals are enabled for the relevant OPCOM classes on the node.

**User Action:** Either nothing or enable an OPCOM terminal, contact the operator and retry.

### **ACCCTRLONLY**

updated access control only

**Explanation:** You entered a SET command and you only had CONTROL access to the object, so only the access control information (if any) was updated.

**User Action:** If this is what was intended no action is needed. If you wish to update other fields in the object, you require SET access control. See your administrator.

### **ACCVIO**

access violation

**Explanation:**

The MDMS software caused an access violation. This is an internal error.

**User Action:**

Provide copies of the MDMS command issued, the database files and the server's logfile for further analysis.

### **ALLOCDRIVE**

drive !AD allocated

**Explanation:**

The named drive was successfully allocated.

**User Action:**

None.

### **ALLOCDRIVEDEV**

drive !AD allocated as device !AD

**Explanation:**

The named drive was successfully allocated, and the drive may be accessed with DCL commands using the device name shown.

**User Action:**

None.

## MDMS Messages

### **ALLOCVOLUME**

volume !AD allocated

#### **Explanation:**

The named volume was successfully allocated.

#### **User Action:**

None.

### **ALTSUCCESS**

alternative success

#### **Explanation:**

The request was successful, but extended status contains information.

#### **User Action:**

Examine the extended status, and retry command as needed.

### **APIBUGCHECK**

internal inconsistency in API

#### **Explanation:**

The MDMS API (MDMS\$SHR.EXE) detected an inconsistency. This is an internal error.

#### **User Action:**

Provide copies of the MDMS command issued, the database files and the server's logfile for further analysis.

### **APIUNEXP**

unexpected error in API !AZ line !UL

#### **Explanation:**

The shareable image MDMS\$SHR detected an internal inconsistency.

#### **User Action:**

Provide copies of the MDMS command issued, the database files and the server's logfile for further analysis.

### **ARCUNDEFINED**

referenced archive(s) !AZ undefined

#### **Explanation:**

When creating or modifying a valid object, the object's record contains a reference to a archive name that does not exist. One or more of the specified archives may be undefined.

#### **User Action:**

Check spelling of the archive names and retry, or create the archive objects in the database.

### **ATTRINMAG**

onsite/offsite attributes invalid for magazine-based volumes

#### **Explanation:**

You attempted to specify offsite or onsite dates or locations for a volume whose placement is in a magazine. These attributes are controlled by the magazine and are not valid for individual volumes.

**User Action:**

Specify the dates and locations in the magazine object, or do not use magazines for volumes if you want the individual offsite/onsite dates to be different for each volume.

**BINDVOLUME**

volume !AD bound to set !AD

**Explanation:**

The specified volume (or volume set) was successfully bound to the end of the named volume set.

**User Action:**

None.

**BUGCHECK**

internal inconsistency

**Explanation:**

The server software detected an inconsistency. This is an internal error.

**User Action:**

Provide copies of the MDMS command issued, the database files and the server's logfile for further analysis. Restart the server.

**CANCELLED**

request cancelled by user

**Explanation:**

The request was cancelled by a user issuing a cancel request command.

**User Action:**

None, or retry command.

**CLEANVOL**

cleaning volume loaded

**Explanation:**

During a load of a volume, a cleaning volume was loaded.

**User Action:**

During an inventory this message can be ignored. During a load of a requested volume or a scratch load on a drive, or an initialize command, a cleaning volumes was loaded. Check location of the cleaning volume, update database as needed, and re-issue command using a non-cleaning volume.

**CONFLITEMS**

conflicting item codes specified

**Explanation:**

The command cannot be completed because there are conflicting item codes in the command. This is an internal error.

**User Action:**

Provide copies of the MDMS command issued, the database files and the server's logfile for further analysis.

## MDMS Messages

### **CREATVOLUME**

volume !AD created

#### **Explanation:**

The named volume was successfully created.

#### **User Action:**

None.

### **DBLOCACC**

local access to database

#### **Explanation:**

This node has the database files open locally.

#### **User Action:**

None.

### **DBRECERR**

error !AZ !AZ record for !AZ:

#### **Explanation:**

The search for a database server received an error from a remote server.

#### **User Action:**

Check the logfile on the remote server for more information. Check the logical name MDMS\$DATABASE\_SERVERS for correct entries of database server node.

### **DBREMACC**

access to remote database server on node !AZ

#### **Explanation:**

This node has access to a remote database server.

#### **User Action:**

None.

### **DBREP**

Database server on node !AZ reports:

#### **Explanation:**

The remote database server has reported an error condition. The next line contains additional information.

#### **User Action:**

Depends on the additional information.

### **DCLARGLSOVR**

DCL extended status format, argument list overflow

#### **Explanation:**

During formatting of the extended status, the number of arguments exceeded the allowable limit. This is an internal error.

**User Action:**

Provide copies of the MDMS command issued, the database files and the server's logfile for further analysis.

**DCLBUGCHECK**

internal inconsistency in DCL

**Explanation:**

The MDMS command line software (MDMS\$DCL.EXE) detected an inconsistency. This is an internal error.

**User Action:**

Provide copies of the MDMS command issued, the database files and the server's logfile for further analysis.

**DCSCERROR**

error accessing jukebox with DCSC

**Explanation:**

MDMS encountered an error when performing a jukebox operation. An accompanying message gives more detail.

**User Action:**

Examine the accompanying message and perform corrective actions to the hardware, the volume or the database, and optionally retry the operation.

**DCSCMSG**

!AZ

**Explanation:**

This is a more detailed DCSC error message which accompanies DCSCERROR.

**User Action:**

Check the DCSC error message file.

**DECNETLISEXIT**

DECnet listener exited

**Explanation:**

The DECnet listener has exited due to an internal error condition or because the user has disabled the DECNET transport for this node. The DECnet listener is the server's routine to receive requests via DECnet (Phase IV and Phase V).

**User Action:**

The DECnet listener should be automatically restarted unless the DECNET transport has been disabled for this node. Provide copies of the MDMS command issued, the database files and the server's logfile for further analysis if the transport has not been disabled by the user.

**DECNETLISRUN**

listening on DECnet node !AZ object !AZ

**Explanation:**

The server has successfully started a DECnet listener. Requests can now be sent to the server via DECnet.

## MDMS Messages

**User Action:**

None.

**DEVNAMICM**

device name item code missing

**Explanation:**

During the allocation of a drive, the drive name was not returned by the server. This is an internal error.

**User Action:**

Provide copies of the MDMS command issued, the database files and the server's logfile for further analysis.

**DRIVEEXISTS**

specified drive already exists

**Explanation:**

The specified drive already exists and cannot be created.

**User Action:**

Use a set command to modify the drive, or create a new drive with a different name.

**DRVACCERR**

error accessing drive

**Explanation:**

MDMS could not access the drive.

**User Action:**

Verify the VMS device name, node names and/or group names specified in the drive record. Fix if necessary. Verify MDMS is running on a remote node. Check status of the drive, correct and retry.

**DRVALRALLOC**

drive is already allocated

**Explanation:**

An attempt was made to allocate a drive that was already allocated.

**User Action:**

Wait for the drive to become deallocated, or if the drive is allocated to you, use it.

**DRVEMPTY**

drive is empty or volume in drive is unloaded

**Explanation:** The specified drive is empty, or the volume in the drive is unloaded, spun-down and inaccessible.

**User Action:**

Check status of drive, correct and retry.

**DRVINITERR**

error initializing drive on platform

**Explanation:**

MDMS could not initialize a volume in a drive.



**User Action:**

There was a system error initializing the volume. Check the log file.

**DRVINUSE**

drive is currently in use

**Explanation:**

The specified drive is already in use.

**User Action:**

Wait for the drive to free up and re-enter command, or try to use another drive.

**DRVLOADED**

drive is already loaded

**Explanation:**

A drive unload appeared to succeed, but the specified volume was still detected in the drive.

**User Action:**

Check the drive and check for duplicate volume labels, or if the volume was reloaded.

**DRVLOADING**

drive is currently being loaded or unloaded

**Explanation:**

The operation cannot be performed because the drive is being loaded or unloaded.

**User Action:**

Wait for the drive to become available, or use another drive. If the drive is stuck in the loading or unloading state, check for an outstanding request on the drive and cancel it. If all else fails, manually adjust the drive state.

**DRVNOTALLOC**

drive is not allocated

**Explanation:**

The specified drive could not be allocated.

**User Action:**

Check again if the drive is allocated. If it is, wait until it is deallocated. Otherwise there was some other reason the drive could not be allocated. Check the log file.

**DRVNOTALLUSER**

drive is not allocated to user

**Explanation:**

You cannot perform the operation on the drive because the drive is not allocated to you.

**User Action:**

Either defer the operation or (in some cases) you may be able to perform the operation specifying a user name.

**DRVNOTAVAIL**

drive is not available on system

## MDMS Messages

### **Explanation:**

The specified drive was found on the system, but is not available for use.

### **User Action:**

Check the status of the drive and correct.

### **DRVNOTDEALLOC**

drive was not deallocated

### **Explanation:**

MDMS could not deallocate a drive.

### **User Action:**

Either the drive was not allocated or there was a system error deallocating the drive. Check the log file.

### **DRVNOTFOUND**

drive not found on system

### **Explanation:**

The specified drive cannot be found on the system.

### **User Action:**

Check that the OpenVMS device name, node names and/or group names are correct for the drive. Verify MDMS is running on a remote node. Re-enter command when corrected.

### **DRVNOTSPEC**

drive not specified or allocated to volume

### **Explanation:**

When loading a volume a drive was not specified, and no drive has been allocated to the volume.

### **User Action:**

Retry the operation and specify a drive name.

### **DRVREMOTE**

drive is remote

### **Explanation:**

The specified drive is remote on a node where it is defined to be local.

### **User Action:**

Check that the OpenVMS device name, node names and/or group names are correct for the drive. Verify MDMS is running on a remote node. Re-enter command when corrected.

### **DRVSINUSE**

all drives are currently in use

### **Explanation:**

All of the drives matching the selection criteria are currently in use.

### **User Action:**

Wait for a drive to free up and re-enter command.

### **DRVUNDEFINED**

referenced drive !AZ undefined

#### **Explanation:**

When creating or modifying a valid object, the object's record contains a reference to a drive name that does not exist.

#### **User Action:**

Check spelling of the drive name and retry, or create the drive object in the database.

### **ENVUNDEFINED**

referenced environment(s) !AZ undefined

#### **Explanation:**

When creating or modifying a valid object, the object's record contains a reference to a environment name that does not exist. One or more of the specified environments may be undefined.

#### **User Action:**

Check spelling of the environment names and retry, or create the environment objects in the database.

### **ERROR**

error

#### **Explanation:**

A general internal MDMS error occurred.

#### **User Action:**

Provide copies of the MDMS command issued, the database files and the server's logfile for further analysis.

### **EXECOMFAIL**

execute command failed, see log file for more explanation

#### **Explanation:**

While trying to execute a command during scheduled activities, a system service called failed.

#### **User Action:**

Check the log file for the failure code from the system server call.

### **EXIT**

MDMS server exiting with fatal error, restarting

#### **Explanation:**

The MDMS server has encountered a fatal error and is exiting. The server will be restarted.

#### **User Action:**

Report incident to Compaq.

### **EXSCHED**

internal schedules are inoperable; external scheduler in use

## MDMS Messages

### **Explanation:**

You have created or modified an MDMS schedule object. This is allowed, but since the domain scheduler type is set up to an external scheduler product, this schedule object will never be executed.

### **User Action:**

If you are not planning to change the scheduler type to INTERNAL or EXTERNAL, you should modify the associated save or restore request to use a standard frequency or an explicit frequency.

### **EXTRAVOL**

extra volume(s) processed

### **Explanation:**

One or more volumes unknown to MDMS have been processed by this command.

### **User Action:**

See next message line(s) for more details. Use MDMS or jukebox utility programs (MRU or CARTRIDGE) to correct the problem.

### **FAILALLODRV**

failed to allocate drive

### **Explanation:**

Failed to allocate drive.

### **User Action:**

The previous message is the error that caused the failure.

### **FAILCONSVR**

failed connection to server

### **Explanation:**

The connection to an MDMS server either failed or could not be established. See additional message lines and/or check the server's logfile.

### **User Action:**

Depends on additional information.

### **FAILCONSVRD**

failed connection to server via DECnet

### **Explanation:**

The DECnet connection to an MDMS server either failed or could not be established. See additional message lines and/or check the server's logfile.

### **User Action:**

Depends on additional information.

### **FAILCONSVRT**

failed connection to server via TCP/IP

### **Explanation:**

The TCP/IP connection to an MDMS server either failed or could not be established. See additional message lines and/or check the server's logfile.

**User Action:**

Depends on additional information.

**FAILCREATE**

failed to create !AZ

**Explanation:**

The reported file or object could not be created. The next line contains additional information.

**User Action:**

Depends on the additional information.

**FAILDEALLOCDRV**

failed to deallocate drive

**Explanation:**

Failed to deallocate drive.

**User Action:**

The previous message is the error that caused the failure.

**FAILDELETE**

failed to delete !AZ

**Explanation:**

The reported file or object could not be deleted. The next line contains additional information.

**User Action:**

Depends on the additional information.

**FAILED MNTVOL**

failed to mount volume

**Explanation:**

MDMS was unable to mount the volume.

**User Action:**

The error above this contains the error that cause the volume not to be mounted.

**FAILICRES**

failed item code restrictions

**Explanation:**

The command cannot be completed because there are conflicting item codes in the command. This is an internal error.

**User Action:**

Provide copies of the MDMS command issued, the database files and the server's logfile for further analysis.

**FAILINIEXTSTAT**

failed to initialize extended status buffer

**Explanation:**

The API could not initialize the extended status buffer. This is an internal error.

## MDMS Messages

### **User Action:**

Provide copies of the MDMS command issued, the database files and the server's logfile for further analysis.

### **FAILLOOKUP**

failed to lookup !AZ

### **Explanation:**

The reported file or object could not be looked up. The next line contains additional information.

### **User Action:**

Depends on the additional information.

### **FAILURE**

fatal error

### **Explanation:**

The MDMS server encountered a fatal error during the processing of a request.

### **User Action:**

Provide copies of the MDMS command issued, the database files and the server's logfile for further analysis.

### **FILOPNERR**

file !AZ could not be opened

### **Explanation:**

An MDMS database file could not be opened.

### **User Action:**

Check the server's logfile for more information.

### **FIRSTVOLUME**

specified volume is first in set

### **Explanation:**

The specified volume is the first volume in a volume set.

### **User Action:**

You cannot deallocate or unbind the first volume in a volume set. However, you can unbind the second volume and then deallocate the first, or unbind and deallocate the entire volume set.

### **FUNCFAILED**

Function !AZ failed with:

### **Explanation:**

An internal call to a system function has failed. The following lines identify the function called and the failure status.

### **User Action:**

Depends on information following this message.

### **GRPUNDEFINED**

referenced group(s) !AZ undefined

**Explanation:**

When creating or modifying a valid object, the object's record contains a reference to a group name that does not exist. One or more of the specified groups may be undefined.

**User Action:**

Check spelling of the group names and retry, or create the group objects in the database.

**ILLEGALOP**

illegal move operation

**Explanation:**

You attempted to move a volume within a DCSC jukebox, and this is not supported.

**User Action:**

None.

**INCOMFREQ**

incompatible frequency for !AZ !AZ

**Explanation:**

After changing the domain scheduler type, MDMS has determined that this save or restore request has a frequency that is incompatible with the new scheduler type. The frequencies that are not valid for the given scheduler types are:

- INTERNAL and EXTERNAL: Explicit
- DECSCHEDULER and SCHEDULER: Custom

**User Action:**

Modify the frequency to a valid one for this scheduler type.

**INCOMPATMED**

volume's media type incompatible with the drive

**Explanation:**

The media type for the volume is incompatible with the media type(s) for the drive on a load operation.

**User Action:**

Verify that the volume can be physically loaded and used in the specified drive. If not, select another drive. If so, then add the volume's media type to the drive or otherwise aligned the media types of the volume and the drive.

**INCOMPATOPT**

incompatible options specified

**Explanation:**

You entered a command with incompatible options.

**User Action:**

Examine the command documentation and re-enter with allowed combinations of options.

**INCOMPATTR**

attributes incompatible with archive type

## MDMS Messages

### **Explanation:**

You attempted to create or set an attribute which is incompatible with the archive type. The following attributes are incompatible for archive types:

- DISK: CONSOLIDATION, DRIVES, MEDIA\_TYPE, POOL, VOLUME\_SETS
- TAPE: DESTINATION

### **User Action:**

Do not specify these attributes if they are incompatible with the archive type.

### **INCOMPATVOL**

volume is incompatible with volumes in set

### **Explanation:**

You cannot bind the volume to the volume set because some of the volume's attributes are incompatible with the volumes in the volume set.

### **User Action:**

Check that the new volume's media type, onsite location and offsite location are compatible with those in the volume set. Adjust attributes and retry, or use another volume with compatible attributes.

### **INSCMDPRIV**

insufficient privilege to execute request

### **Explanation:**

You do not have sufficient privileges to enter the request.

### **User Action:**

Contact your system administrator and request additional privileges, or give yourself privs and retry.

### **INSOPTPRIV**

insufficient privilege for request option

### **Explanation:**

You do not have sufficient privileges to enter a privileged option of this request.

### **User Action:**

Contact your system administrator and request additional privileges, or give yourself privs and retry. Alternatively, retry without using the privileged option.

### **INSSHOWPRIV**

some volumes not shown due to insufficient privilege

### **Explanation:**

Not all volumes were shown because of restricted privilege.

### **User Action:**

None if you just want to see volumes you own. You need MDMS\_SHOW\_ALL privilege to see all volumes.

### **INSSVRPRV**

insufficient server privileges



**Explanation:**

The MDMS server is running with insufficient privileges to perform system functions.

**User Action:**

Refer to the Installation Guide to determine the required privileges. Contact your system administrator to add these privileges in the MDMS\$SERVER account.

**INTBUFOVR**

internal buffer overflow

**Explanation:**

The MDMS software detected an internal buffer overflow. This an internal error.

**User Action:**

Provide copies of the MDMS command issued, the database files and the server's logfile for further analysis. Restart the server.

**INTINVMSG**

internal invalid message

**Explanation:**

An invalid message was received by a server. This could be due to a network problem or, a remote non-MDMS process sending messages in error or, an internal error.

**User Action:**

If the problem persists and no non-MDMS process can be identified then provide copies of the MDMS command issued, the database files and the server's logfile for further analysis.

**INTSCHEDULE**

cannot modify or delete internal schedule

**Explanation:**

You attempted to modify or delete a schedule object that was internally generated for a save or restore request. This is not allowed.

**User Action:**

Modify or delete the associated save or restore request instead, and the schedule will be updated accordingly.

**INVABSTIME**

invalid absolute time

**Explanation:**

The item list contained an invalid absolute date and time. Time cannot be earlier than 1-Jan-1970 00:00:00 and cannot be greater than 7-Feb-2106 06:28:15

**User Action:**

Check that the time is between these two times.

**INVALIDRANGE**

invalid volume ID or invalid range specified

**Explanation:**

The specified volume ID, volume range, slot range or space range is invalid.

## MDMS Messages

### **User Action:**

A volume ID may contain up to 6 characters. A volume range may contain up to 1000 volume IDs where the first 3 characters must be alphabetic and the last 3 may be alphanumeric. Only the numeric portions may vary in the range. Examples are ABC000-ABC999, or ABCD01-ABCD99. A slot range can contain up to 1000 slots and must be numeric. Also, all slots in the range must be less than the slot count for the jukebox or magazine. Example: 0-255 for a slot count of 256. A space range can contain up to 1000 spaces where the first and last spaces must have the same number of characters. Spaces must be within the range defined for the location. Examples: 000-999, or Space A1-Space C9

### **INVCONSOLVAL**

invalid value for consolidation savesets or volumes

### **Explanation:**

You specified an invalid value for consolidation savesets or volumes.

### **User Action:**

Use a value in the range 0 to maximum integer.

### **INVDBSVRLIS**

invalid database server search list

### **Explanation:**

The logical name MDMS\$DATABASE\_SERVERS contains invalid network node names or is not defined.

### **User Action:**

Correct the node name(s) in the logical name MDMS\$DATABASE\_SERVERS in file MDMS\$SYSTARTUP.COM. Redefine the logical name in the current system. Then start the server.

### **INVDELSTATE**

object is in invalid state for delete

### **Explanation:**

The specified object cannot be deleted because its state indicates it is being used.

### **User Action:**

Defer deletion until the object is no longer being used, or otherwise change its state and retry.

### **INVDELTATIME**

invalid delta time

### **Explanation:**

The item list contained an invalid delta time.

### **User Action:**

Check that the item list has a correct delta time.

### **INVDFULLNAM**

invalid DECnet fullname

### **Explanation:**

A node full name for a DECnet-Plus (Phase V) node specification has an invalid syntax.

**User Action:**

Correct the node name and retry.

**INVDRVCOUNT**

invalid value for drive count, use 1-32

**Explanation:**

You specified an invalid value for drive count.

**User Action:**

Use a value in the range 1-32.

**INVEXTSTS**

invalid extended status item desc/buffer

**Explanation:**

The error cannot be reported in the extended status item descriptor. This error can be caused by one of the following:

- Not being able to read any one of the item descriptors in the item list
- Not being able to write to the buffer in the extended status item descriptor
- Not being able to write to the return length in the extended status item descriptor
- Not being able to initialize the extended status buffer

**User Action:**

Check for any of the errors stated above in your program and fix the error.

**INVFREQUENCY**

invalid frequency for domain scheduler type

**Explanation:**

You specified an invalid save or restore frequency the scheduler type specified in the domain. Invalid combinations include: CUSTOM, with NONE, DECSCHEDULER, SCHEDULER or LOCAL EXPLICIT, with NONE, INTERNAL, EXTERNAL, or SINGLE

**User Action:**

Specify a valid frequency for the scheduler type specified in the domain.

**INVINITOPT**

invalid initialize options specified

**Explanation:**

You attempted initialize volumes in a jukebox by specifying a slot range and the jukebox is not a vision-equipped, MRD-controlled jukebox.

**User Action:**

Specify a volume range instead of a slot range to initialize volumes in a DCSC jukebox or an MRD jukebox without a vision system.

**INVITCODE**

invalid item code for this function

## MDMS Messages

### **Explanation:**

The item list had an invalid item code. The problem could be one of the following:

- Item codes do not meet the restrictions for that function.
- An item code cannot be used in this function.

### **User Action:**

Refer to the API specification to find out which item codes are restricted for each function and which item codes are allowed for each function.

### **INVITDESC**

invalid item descriptor, index !@UL

### **Explanation:**

The item descriptor is in error. The previous message gives the error. Included is the index of the item descriptor in the item list.

### **User Action:**

Refer to the index number and the previous message to indicate the error and which item descriptor is in error.

### **INVITLLENGTH**

invalid item list buffer length

### **Explanation:**

The item list buffer length is zero. The item list buffer length cannot be zero for any item code.

### **User Action:**

Refer to the API specification to find an item code that would be used in place of an item code that has a zero buffer length.

### **INVMAXSAVES**

invalid value for maximum saves, use 1-36

### **Explanation:**

You specified an invalid value for maximum saves.

### **User Action:**

Use a value in the range 1-36.

### **INVMEADIATYPE**

media type is invalid or not supported by volume

### **Explanation:**

The specified volume supports multiple media types where a single media type is required, or the volume does not support the specified media type.

### **User Action:**

Re-enter the command specifying a single media type that is already supported by the volume.

### **INVMSG**

invalid message via !AZ

### **Explanation:**

An invalid message was received MDMS software. This could be due to a network problem or, a non-MDMS process sending messages in error or, an internal error.

### **User Action:**

If the problem persists and no non-MDMS process can be identified then provide copies of the MDMS command issued, the database files and the server's logfile for further analysis.

### **INVNODNAM**

invalid node name specification

### **Explanation:**

A node name for a DECnet (Phase IV) node specification has an invalid syntax.

### **User Action:**

Correct the node name and retry.

### **INVPORTS**

invalid port number specification

### **Explanation:**

The MDMS server did not start up because the logical name MDMS\$TCPIP\_SND\_PORTS in file MDMS\$SYSTARTUP.COM specifies an illegal port number range. A legal port number range is of the form "low\_port\_number-high\_port\_number".

### **User Action:**

Correct the port number range for the logical name MDMS\$TCPIP\_SND\_PORTS in file MDMS\$SYSTARTUP.COM. Then start the server.

### **INVPOSITION**

invalid jukebox position

### **Explanation:**

The position specified is invalid.

### **User Action:**

Position is only valid for jukeboxes with a topology defined. Check that the position is within the topology ranges, correct and retry. Example: /POSITION=(1,2,1)

### **INVRETDAYS**

invalid retention days specified

### **Explanation:**

You entered an invalid value for the retention days. Valid values are 0 to 9999 days. If you wish for no expiration of volumes, specify /NOEXPIRATION\_DATE.

### **User Action:**

Enter a value between 0 and 9999.

### **INVRETRY**

invalid value for retry count or interval

### **Explanation:**

You specified an invalid value for either or both the retry count or interval. In addition, it is invalid to specify an interval with a retry limit of zero or nolimit.

## MDMS Messages

### **User Action:**

Use values within the following ranges:

- RETRY\_LIMIT: 0 - 10000 or NOLIMIT
- INTERVAL: 00:01:00 - 01:00:00 (1 - 60 mins)

### **INVRETRYINTERVAL**

invalid value for retry interval

### **Explanation:**

You specified an invalid value for retry interval. In addition, it is invalid to specify an interval with a retry limit of zero.

### **User Action:**

Use a value within the following range only if retry limit is non-zero: 00:01:00 - 01:00:00 (1 - 60 mins)

### **INVRETRYLIMIT**

invalid value for retry limit

### **Explanation:**

You specified an invalid value for retry limit.

### **User Action:**

Use a value in the range 0 to maximum integer or use /NORETRY\_LIMIT

### **INVSCHEDENUM**

invalid scheduling translation defined

### **Explanation:**

An invalid parameter translation was entered for a scheduling option.

### **User Action:**

Report the incident to Compaq.

### **INVSCHEDOPT**

invalid schedule options entered

### **Explanation:**

You entered invalid schedule date/time options for a schedule object. The following values are allowed:

- DATES: List of values or ranges, values 1 - 31
- DAYS: List of values or ranges, values MON - SUN
- MONTHS: List of values or ranges, values JAN - DEC
- TIMES: List of values, 00:00 - 23:59
- INCLUDE: List of dates 01-Jan-yyyy - 31-Dec-yyyy
- EXCLUDE: List of dates 01-Jan-yyyy - 31-Dec-yyyy

The yyyy for INCLUDE and EXCLUDE must be between the current year and up to 9 years into the future (e.g. 2001-2010). If omitted, the current year is used.

### **User Action:**

Re-enter the command with valid values.

**INVSCHEDPARAM**

invalid scheduling parameter defined

**Explanation:**

An invalid parameter was entered for a scheduling option.

**User Action:**

Report the incident to Compaq.

**INVSELECT**

invalid selection criteria

**Explanation:**

The selection criteria specified on an allocate command are invalid.

**User Action:**

Check the command with the documentation and re-enter with a valid combination of selection criteria.

**INVSLOT**

invalid slot or slot range specified

**Explanation:**

The slot or slot range specified when moving volumes into a magazine or jukebox was invalid, or the specified slots were already occupied.

**User Action:**

Specify valid empty slots and re-enter.

**INVSLOT RANGE**

invalid slot range

**Explanation:**

The slot range was invalid. It must be of the form: 1-100 1,100-200,300-400 The only characters allowed are comma, dash, and numbers (0-9).

**User Action:**

Check that you are using the correct form.

**INVSPACE**

invalid space or space range specified

**Explanation:**

The space or space range specified when moving volumes into a location was invalid.

**User Action:**

Specify valid spaces already defined for the location, or specify a space range for the location

**INVSRCDEST**

invalid source or destination for move

**Explanation:**

Either the source or destination of a move operation was invalid (does not exist).

## MDMS Messages

### **User Action:**

If the destination is invalid, enter a correct destination and retry. If a source is invalid, either create the source or correct the current placement of the affected volumes or magazines.

### **INVSTATE**

volume !AZ is in an invalid state for initialization

### **Explanation:**

The volume loaded in the drive for initialization was either allocated or in the transition state and cannot be initialized.

### **User Action:**

Either the wrong volume was loaded, or the requested volume was in an invalid state. If the wrong volume was loaded, perform an inventory on the jukebox and retry. If the volume is allocated or in transition, you should not try to initialize the volume.

### **INVTFULLNAM**

invalid TCP/IP fullname

### **Explanation:**

A node full name for a TCP/IP node specification has an invalid syntax.

### **User Action:**

Correct the node name and retry.

### **INVTOPOLOGY**

invalid jukebox topology

### **Explanation:**

The specified topology for a jukebox is invalid.

### **User Action:**

Check topology definition; the towers must be sequentially increasing from 0; there must be a face, level and slot definition for each tower. Example: /TOPOLOGY=(TOWER=(0,1,2), FACES=(8,8,8), - LEVELS=(2,3,2), SLOTS=(13,13,13))

### **INVVOLPLACE**

invalid volume placement for operation

### **Explanation:**

The volume has an invalid placement for a load operation.

### **User Action:**

Re-enter the command and use the move option.

### **INVVOLSTATE**

volume in invalid state for operation

### **Explanation:**

The operation cannot be performed on the volume because of the volume state does not allow it.

### **User Action:**

Defer the operation until the volume changes state. If the volume is stuck in a transient state (e.g. moving), check for an outstanding request and cancel it. If all else fails, manually change the state.



**JUKEBOXEXISTS**

specified jukebox already exists

**Explanation:**

The specified jukebox already exists and cannot be created.

**User Action:**

Use a set command to modify the jukebox, or create a new jukebox with a different name.

**JUKENOTINIT**

jukebox could not be initialized

**Explanation:**

An operation on a jukebox failed because the jukebox could not be initialized.

**User Action:**

Check the control, robot name, node name and group name of the jukebox, and correct as needed. Check access path to jukebox (HSJ etc), correct as needed. Verify MDMS is running on a remote node. Then retry operation.

**JUKETIMEOUT**

timeout waiting for jukebox to become available

**Explanation:**

MDMS timed out waiting for a jukebox to become available. The timeout value is 10 minutes.

**User Action:**

If the jukebox is in heavy use, try again later. Otherwise, check requests for a hung request - cancel it. Set the jukebox state to available if all else fails.

**JUKEUNAVAIL**

jukebox is currently unavailable

**Explanation:**

The jukebox is disabled.

**User Action:**

Re-enable the jukebox.

**JUKUNDEFINED**

referenced jukebox !AZ undefined

**Explanation:**

When creating or modifying a valid object, the object's record contains a reference to a jukebox name that does not exist.

**User Action:**

Check spelling of the jukebox name and retry, or create the jukebox object in the database.

**LOCATIONEXISTS**

specified location already exists

**Explanation:**

The specified location already exists and cannot be created.

## MDMS Messages

### **User Action:**

Use a set command to modify the location, or create a new location with a different name.

### **LOCUNDEFINED**

referenced location !AZ undefined

### **Explanation:**

When creating or modifying a valid object, the object's record contains a reference to a location name that does not exist.

### **User Action:**

Check spelling of the location name and retry, or create the location object in the database.

### **LOGRESET**

Log file !AZ by !AZ on node !AZ

### **Explanation:**

The server logfile has been closed and a new version has been created by a user.

### **User Action:**

None.

### **MAGAZINEEXISTS**

specified magazine already exists

### **Explanation:**

The specified magazine already exists and cannot be created.

### **User Action:**

Use a set command to modify the magazine, or create a new magazine with a different name.

### **MAGUNDEFINED**

referenced magazine !AZ undefined

### **Explanation:**

When creating or modifying a valid object, the object's record contains a reference to a magazine name that does not exist.

### **User Action:**

Check spelling of the magazine name and retry, or create the magazine object in the database.

### **MBLISEXIT**

mailbox listener exited

### **Explanation:**

The mailbox listener has exited due to an internal error condition. The mailbox listener is the server's routine to receive local user requests through mailbox MDMS\$MAILBOX.

### **User Action:**

The mailbox listener should be automatically restarted. Provide copies of the MDMS command issued, the database files and the server's logfile for further analysis.

### **MBLISRUN**

listening on mailbox !AZ logical !AZ

**Explanation:**

The server has successfully started the mailbox listener. MDMS commands can now be entered on this node.

**User Action:**

None.

**MEDIATYPEEXISTS**

specified media type already exists

**Explanation:**

The specified media type already exists and cannot be created.

**User Action:**

Use a set command to modify the media type, or create a new media type with a different name.

**MEDUNDEFINED**

referenced media type(s) !AZ undefined

**Explanation:**

When creating or modifying a valid object, the object's record contains a reference to a media type that does not exist. One or more of the specified media types may be undefined.

**User Action:**

Check spelling of the media types and retry, or create the media type objects in the database.

**MOVEINCOMPL**

move is incomplete

**Explanation:**

When moving volumes into and out of a jukebox, some of the volumes were not moved.

**User Action:**

Check that there are enough empty slots in the jukebox when moving in and retry. On a move out, examine the cause of the failure and retry.

**MRDERROR**

error accessing jukebox with MRD

**Explanation:**

MDMS encountered an error when performing a jukebox operation. An accompanying message gives more detail.

**User Action:**

Examine the accompanying message and perform corrective actions to the hardware, the volume or the database, and optionally retry the operation.

**MRDMSG**

!AZ

**Explanation:**

This is a more detailed MRD error message which accompanies MRDERROR.

**User Action:**

Check the MRU error message file.

## MDMS Messages

### **NOACCESS**

no user access to object for operation

#### **Explanation:**

You attempted to perform an operation on an object for which you have no access.

#### **User Action:**

You need an authorized user to add you to the access control list, otherwise you cannot perform the requested operation.

### **NOBINDSELF**

volume is already in volume set

#### **Explanation:**

You cannot bind this volume into this volume set because it already a member of the volume set.

#### **User Action:**

Use another volume.

### **NOCHANGES**

no attributes were changed in the database

#### **Explanation:**

Your set command did not change any attributes in the database because the attributes you entered were already set to those values.

#### **User Action:**

Double-check your command, and re-enter if necessary. Otherwise the database is already set to what you entered.

### **NOCHANGESOBJ**

no attributes were changed for !AZ !AZ

#### **Explanation:**

Your set command did not change any attributes in the database because the attributes you entered were already set to those values. The message indicates which object was not changed.

#### **User Action:**

Double-check your command, and re-enter if necessary. Otherwise the database is already set to what you entered.

### **NOCHECK**

drive not accessible, check not performed

#### **Explanation:**

The specified drive could not be physically accessed and the label check was not performed. The displayed attributes are taken from the database.

#### **User Action:**

Verify the VMS device name, node name or group name in the drive object. Check availability on system. Verify MDMS is running on a remote node. Determine the reason the drive was not accessible, fix it and retry.

### **NODBACC**

no access to database server

**Explanation:**

This server has no access to a database server.

**User Action:**

Verify the setting of logical name MDMS\$DATABASE\_SERVERS. Check each node listed using MDMS SHOW SERVER/NODE=... for connectivity and database access status. Check the servers logfiles for more information.

**NODCSC**

DCSC not running

**Explanation:**

DCSC has not been started.

**User Action:**

Execute command procedure SYS\$STARTUP:DCSC\$STARTUP.COM and retry command.

**NODEDISABLED**

node disabled

**Explanation:**

The server failed to start up because it is disabled in the database.

**User Action:**

If necessary correct the setting and start the server again.

**NODEEXISTS**

specified node already exists

**Explanation:**

The specified node already exists and cannot be created.

**User Action:**

Use a set command to modify the node, or create a new node with a different name.

**NODENOPRIV**

node is not privileged to access database server

**Explanation:**

A remote server access failed because the user making the DECnet connection is not MDMS\$SERVER or the remote port number is not less than 1024.

**User Action:**

Verify with DCL command SHOW PROCESS that the remote MDMS server is running under a username of MDMS\$SERVER and/or, verify that logical name MDMS\$TCPIP\_SND\_PORTS on the remote server node specifies a port number range between 0-1023.

**NODENOTENA**

node not in database or not fully enabled

**Explanation:**

The server was not allowed to start up because there is no such node object in the database or its node object in the database does not specify all network full names correctly.

## MDMS Messages

### **User Action:**

For a node running DECnet (Phase IV) the node name has to match logical name SYS\$NODE on that node. For a node running DECnet-Plus (Phase V) the node's DECNET\_PLUS\_FULLNAME has to match the logical name SYS\$NODE\_FULLNAME on that node. For a node running TCP/IP the node's TCPIP\_FULLNAME has to match the full name combined from logical names \*INET\_HOST and \*INET\_DOMAIN.

### **NODENOTINDB**

no node object with !AZ name !AZ in database

### **Explanation:**

The current server could not find a node object in the database with a matching DECnet (Phase IV) or DECnet-Plus (Phase V) or TCP/IP node full name.

### **User Action:**

Use SHOW SERVER/NODES=(...) to see the exact naming of the server's network names. Correct the entry in the database and restart the server.

### **NODRIVES**

no drives match selection criteria

### **Explanation:**

When allocating a drive, none of the drives match the specified selection criteria.

### **User Action:**

Check spelling and re-enter command with valid selection criteria.

### **NODRVACC**

access to drive disallowed

### **Explanation:**

You attempted to allocate, load or unload a drive from a node that is not allowed to access it.

### **User Action:**

The access field in the drive object allows local, remote or all access, and your attempted access did not conform to the attribute. Use another drive.

### **NODRVSAVAIL**

no drives are currently available

### **Explanation:**

All of the drives matching the selection criteria are currently in use or otherwise unavailable.

### **User Action:**

Check to see if any of the drives are disabled or inaccessible. Re-enter command when corrected.

### **NODRVGRP**

no drives in the specified group were found

### **Explanation:**

When allocating a drive, no drives on nodes in the specified group were found.

### **User Action:**

Check group name and retry command.

**NODRVSJUKE**

no drives in the specified jukebox were found

**Explanation:**

When allocating a drive, no drives in the specified jukebox were found.

**User Action:**

Check jukebox name and retry command.

**NODRVSLOC**

no drives in the specified location were found

**Explanation:**

When allocating a drives, no drives in the specified location were found.

**User Action:**

Check location name and retry command.

**NODRVSMED**

no drives with the specified media type were found

**Explanation:**

When allocating a drive, no drives with the specified media type were found.

**User Action:**

Check media type and retry command, or specify the media type for more drives.

**NODRVSNOD**

no drives on the specified node were found

**Explanation:**

When allocating a drive, no drives on the specified node were found.

**User Action:**

Check the node name and retry command.

**NODRVSVOL**

no drives that can support the specified volume were found

**Explanation:**

When allocating a drive, no drives that could support the specified volume were found.

**User Action:**

Check the volume ID and retry command, or check and adjust volume attributes to match a valid drive.

**NODUNDEFINED**

referenced node(s) !AZ undefined

**Explanation:**

When creating or modifying a valid object, the object's record contains a reference to a node name that does not exist. One or more of the specified nodes may be undefined.

**User Action:**

Check spelling of the node names and retry, or create the node objects in the database.

## MDMS Messages

### **NOFIELDS**

no fields specified for report

#### **Explanation:**

A REPORT VOLUME command was entered with no fields to select or display.

#### **User Action:**

Enter at least one field for the report.

### **NOINCLUDE**

selection attributes not set with no include data

#### **Explanation:**

You specified one or more of the following attributes which are not valid unless an include specification is present: DATA\_TYPE, INCREMENTAL, NODES, GROUPS The save or restore object was updated, but selection attributes were not set.

#### **User Action:**

These attributes are applicable only when an INCLUDE statement is present. Re-enter the command with an INCLUDE qualifier.

### **NOINCLUDES**

no include specification for selection

#### **Explanation:**

A save or restore object had some selection attributes specified, but no include file specification. The following attributes require an include specification:

- Data type
- Incremental
- Groups
- Nodes

#### **User Action:**

Re-enter the command with an include specification.

### **NOINTSCHED**

internal scheduling not enabled

#### **Explanation:**

You attempted to create a schedule object but the domain's scheduler option is set to an external scheduler. The MDMS schedule object is valid only with scheduler options INTERNAL, EXTERNAL and SINGLE\_SCHEDULER.

#### **User Action:**

Schedule your request using the specified external scheduler product and interface.

### **NOJUKEACC**

access to jukebox disallowed

#### **Explanation:**

You attempted to use a jukebox from a node that is not allowed to access it.



**User Action:**

The access field in the jukebox object allows local, remote or all access, and your attempted access did not conform to the attribute. Use another jukebox.

**NOJUKESPEC**

jukebox required on vision option

**Explanation:**

The jukebox option is missing on a create volume request with the vision option.

**User Action:**

Re-enter the request and specify a jukebox name and slot range.

**NOLICENSE**

your current license does not support this operation

**Explanation:**

The requested operation is not licensed. If you are licensed for ABS\_OMT only, you have attempted to perform an operation that requires a full ABS license.

**User Action:**

Use an alternative mechanism to perform the operation. If this is not possible, you cannot perform the operation with your current license. You may purchase an upgrade ABS license to enable full ABS functionality. Contact Compaq for details.

**NOMAGAZINES**

no magazines match selection criteria

**Explanation:**

On a move magazine request using the schedule option, no magazines were scheduled to be moved.

**User Action:**

None.

**NOMAGSMOVED**

no magazines were moved

**Explanation:**

No magazines were moved for a move magazine operation. An accompanying message gives a reason.

**User Action:**

Check the accompanying message, correct and retry.

**NOMEDIATYPE**

no media type specified when required

**Explanation:**

An allocation for a volume based on node, group or location also requires the media type to be specified.

**User Action:**

Re-enter the command with a media type specification.

## MDMS Messages

### **NOMEMORY**

not enough memory

#### **Explanation:**

The MDMS server failed to allocate enough virtual memory for an operation. This is an internal error.

#### **User Action:**

Provide copies of the MDMS command issued, the database files and the server's logfile for further analysis. Restart the server.

### **NOOBJECTS**

no such objects currently exist

#### **Explanation:**

On a show command, there are no such objects currently defined.

#### **User Action:**

None.

### **NOPARAM**

required parameter missing

#### **Explanation:**

A required input parameter to a request or an API function was missing.

#### **User Action:**

Re-enter the command with the missing parameter, or refer to the API specification for required parameters for each function.

### **NOPOOLSPEC**

no free volumes with no pool or your default pool were found

#### **Explanation:**

When allocating a volume, no free volumes that do not have a pool defined or that are in your default pool were found.

#### **User Action:**

Add a pool specification to the command, or define more free volumes with no pool or your default pool.

### **NORANGESUPP**

slot or space ranges not supported with volset option

#### **Explanation:**

On a set volume, you entered the volset option and specified either a slot range or space range.

#### **User Action:**

If you want to assign slots or spaces to volumes directly, do not use the volset option.

### **NORECVPORTS**

no available receive port numbers for incoming connections

#### **Explanation:**

The MDMS could not start the TCP/IP listener because none of the receive ports specified with this node's TCPIP\_FULLNAME are currently available.

**User Action:**

Use a suitable network utility to find a free range of TCP/IP ports which can be used by the MDMS server. Use the MDMS SET NODE command to specify the new range with the /TCPIP\_FULLNAME then restart the server.

**NOREMCONNECT**

unable to connect to remote node

**Explanation:**

The server could not establish a connection to a remote node. See the server's logfile for more information.

**User Action:**

Depends on information in the logfile.

**NOREQUESTS**

no such requests currently exist

**Explanation:**

No requests exist on the system.

**User Action:**

None.

**NORESEFN**

not enough event flags

**Explanation:**

The server ran out of event flags. This is an internal error.

**User Action:**

Provide copies of the MDMS command issued, the database files and the server's logfile for further analysis. Restart the server.

**NORIGHTS**

no rights are shown

**Explanation:**

When showing a domain, the rights are not shown because you don't have privilege to see the rights.

**User Action:**

Nothing. To see rights you need MDMS\_SHOW\_RIGHTS.

**NOSCHEDULE**

schedule object invalid for scheduler type or frequency

**Explanation:**

You specified a schedule object for a non-custom frequency or for an external scheduler option. A schedule object can only be specified for frequency CUSTOM with domain scheduler type of INTERNAL, EXTERNAL or SINGLE.

**User Action:**

Do not specify a schedule name.

## MDMS Messages

### **NOSCRATCH**

scratch loads not supported for jukebox drives

#### **Explanation:**

You attempted a load drive command for a jukebox drive.

#### **User Action:**

Scratch loads are not supported for jukebox drives. You must use the load volume command to load volumes in jukebox drives.

### **NOSENDPORTS**

no available send port numbers for outgoing connection

#### **Explanation:**

The server could not make an outgoing TCP/IP connection because none of the send ports specified for the range in logical name MDMS\$TCPIP\_SND\_PORTS are currently available.

#### **User Action:**

Use a suitable network utility to find a free range of TCP/IP ports which can be used by the MDMS server. Change the logical name MDMS\$TCPIP\_SND\_PORTS in file MDMS\$SYS-TARTUP.COM. Then restart the server.

### **NOSLOT**

not enough slots defined for operation

#### **Explanation:**

The command cannot be completed because there are not enough slots specified in the command, or because there are not enough empty slots in the jukebox.

#### **User Action:**

If the jukebox is full, move some other volumes out of the jukebox and retry. If there are not enough slots specified in the command, re-enter with a larger slot range.

### **NOSTATUS**

no status defined

#### **Explanation:**

An uninitialized status has been reported. This an internal error.

#### **User Action:**

Provide copies of the MDMS command issued, the database files and the server's logfile for further analysis.

### **NOSUCHDEST**

specified destination does not exist

#### **Explanation:**

In a move command, the specified destination does not exist.

#### **User Action:**

Check spelling or create the destination as needed.

### **NOSUCHDRIVE**

specified drive does not exist

**Explanation:**

The specified drive does not exist.

**User Action:**

Check spelling or create drive as needed.

**NOSUCHGROUP**

specified group does not exist

**Explanation:**

The specified group does not exist.

**User Action:**

Check spelling or create group as needed.

**NOSUCHINHERIT**

specified inherited object does not exist

**Explanation:**

On a create of an object, the object specified for inherit does not exist.

**User Action:**

Check spelling or create the inherited object as needed.

**NOSUCHJUKEBOX**

specified jukebox does not exist

**Explanation:**

The specified jukebox does not exist.

**User Action:**

Check spelling or create jukebox as needed.

**NOSUCHLOCATION**

specified location does not exist

**Explanation:**

The specified location does not exist.

**User Action:**

Check spelling or create location as needed.

**NOSUCHMAGAZINE**

specified magazine does not exist

**Explanation:**

The specified magazine does not exist.

**User Action:**

Check spelling or create magazine as needed.

**NOSUCHMEDIATYPE**

specified media type does not exist

**Explanation:**

The specified media type does not exist.

## MDMS Messages

**User Action:**

Check spelling or create media type as needed.

**NOSUCHNODE**

specified node does not exist

**Explanation:**

The specified node does not exist.

**User Action:**

Check spelling or create node as needed.

**NOSUCHOBJECT**

specified object does not exist

**Explanation:**

The specified object does not exist.

**User Action:**

Check spelling or create the object as needed.

**NOSUCHPOOL**

specified pool does not exist

**Explanation:**

The specified pool does not exist.

**User Action:**

Check spelling or create pool as needed.

**NOSUCHREQUESTID**

specified request does not exist

**Explanation:**

The specified request does not exist on the system.

**User Action:**

Check the request id again, and re-enter if incorrect.

**NOSUCHUSER**

no such user on system

**Explanation:**

The username specified in the command does not exist.

**User Action:**

Check spelling of the username and re-enter.

**NOSUCHVOLUME**

specified volume(s) do not exist

**Explanation:**

The specified volume or volumes do not exist.

**User Action:**

Check spelling or create volume(s) as needed.

**NOSVRACCOUNT**

username !AZ does not exist

**Explanation:**

The server cannot startup because the username MDMS\$SERVER is not defined in file SYSUAF.DAT.

**User Action:**

Enter the username of MDMS\$SERVER (see Installation manual for account details) and then start the server.

**NOSVRMB**

no server mailbox or server not running

**Explanation:**

The MDMS server is not running on this node or the server is not servicing the mailbox via logical name MDMS\$MAILBOX.

**User Action:**

Use the MDMS\$STARTUP procedure with parameter RESTART to restart the server. If the problem persists, check the server's logfile and file SYS\$MANAGER:MDMS\$SERVER.LOG for more information.

**NOSYMBOLS**

symbols not supported for multiple volumes

**Explanation:**

A SHOW VOLUME/SYMBOLS command was entered for multiple volumes. The /SYMBOLS qualifier is only supported for a single volume.

**User Action:**

Re-enter command with a single volume ID, or don't use the /SYMBOLS qualifier.

**NOTALLOCUSER**

volume is not allocated to user

**Explanation:**

You cannot perform the operation on the volume because the volume is not allocated to you.

**User Action:**

Either use another volume, or (in some cases) you may be able to perform the operation specifying a user name.

**NOTSCHEDULED**

specified save or restore is not scheduled for execution

**Explanation:**

The save or restore request did not contain enough information to schedule the request for execution. The request requires the definition of an archive, an environment and a start time.

**User Action:**

If you wish this request to be scheduled, enter a SET SAVE or SET RESTORE and enter the required information.

**NOUNALLOCDRV**

no unallocated drives found for operation

## MDMS Messages

### **Explanation:**

On an initialize volume request, MDMS could not locate an unallocated drive for the operation.

### **User Action:**

If you had allocated a drive for the operation, deallocate it and retry. If all drives are currently in use, retry the operation later.

### **NOVOLSJUKE**

no free volumes in the specified jukebox were found

### **Explanation:**

When allocating a volume, no free volumes in the specified jukebox were found.

### **User Action:**

Check jukebox name and retry command, or move some free volumes into the jukebox.

### **NOVOLSLLOC**

no free volumes in the specified location were found

### **Explanation:**

When allocating a volume, no free volumes in the specified location were found.

### **User Action:**

Check location name and retry command, or move some free volumes into the location.

### **NOVOLSMED**

no free volumes with the specified media type were found

### **Explanation:**

When allocating a volume, no free volumes with the specified media type were found.

### **User Action:**

Check media type and retry command, or specify the media type for more free volumes.

### **NOVOLSMOVED**

no volumes were moved

### **Explanation:**

No volumes were moved for a move volume operation. An accompanying message gives a reason.

### **User Action:**

Check the accompanying message, correct and retry.

### **NOVOLSPPOOL**

no free volumes in the specified pool were found

### **Explanation:**

When allocating a volume, no free volumes in the specified pool were found.

### **User Action:**

Check pool name and retry command, or specify the pool for more free volumes (add them to the pool).

### **NOVOLSPROC**

no volumes were processed



**Explanation:**

In a create, set or delete volume command, no volumes were processed.

**User Action:**

Check the volume identifiers and re-enter command.

**NOVOLSVOL**

no free volumes matching the specified volume were found

**Explanation:**

When allocating a volume, no free volumes matching the specified volume were found.

**User Action:**

Check the volume ID and retry command, or add more free volumes with matching criteria.

**NOVOLUMES**

no volumes match selection criteria

**Explanation:**

When allocating a volume, no volumes match the specified selection criteria.

**User Action:**

Check the selection criteria. Specifically check the relevant volume pool. If free volumes are in a volume pool, the pool name must be specified in the allocation request, or you must be a default user defined in the pool. You can re-enter the command specifying the volume pool as long as you are an authorized user. Also check that newly-created volumes are in the FREE state rather than the UNITIALIZED state.

**OBJECTEXISTS**

specified object already exists

**Explanation:**

The specified object already exists and cannot be created.

**User Action:**

Use a set command to modify the object, or create a new object with a different name.

**OBJNOTEXIST**

referenced object !AZ does not exist

**Explanation:**

When attempting to allocate a drive or volume, you specified a selection object that does not exist.

**User Action:**

Check spelling of selection criteria objects and retry, or create the object in the database.

**OBJREFZERO**

dereferenced object with zero count

**Explanation:**

The MDMS server software detected an internal inconsistency. This is an internal error.

**User Action:**

Provide copies of the MDMS command issued, the database files and the server's logfile for further analysis.

## MDMS Messages

### **PARTIALSUCCESS**

some volumes in range were not processed

#### **Explanation:**

On a command using a volume range, some of the volumes in the range were not processed.

#### **User Action:**

Verify the state of all objects in the range, and issue corrective commands if necessary.

### **POLUNDEFINED**

referenced pool !AZ undefined

#### **Explanation:**

When creating or modifying a valid object, the object's record contains a reference to a pool name that does not exist.

#### **User Action:**

Check spelling of the pool name and retry, or create the pool object in the database.

### **POOLEXISTS**

specified pool already exists

#### **Explanation:**

The specified pool already exists and cannot be created.

#### **User Action:**

Use a set command to modify the pool, or create a new pool with a different name.

### **PROFERROR**

profile specification error

#### **Explanation:**

You specified an invalid user profile for the environment. Verify that the user name specified (default is ABS) exists on the specified node or cluster.

#### **User Action:**

Re-enter with a valid combination of node or cluster name and user name.

### **QUEUED**

operation is queued for processing

#### **Explanation:**

The asynchronous request you entered has been queued for processing.

#### **User Action:**

You can check on the state of the request by issuing a show requests command.

### **RDFERROR**

error allocating or deallocating RDF device

#### **Explanation:**

During an allocation or deallocation of a drive using RDF, the RDF software returned an error.

#### **User Action:**

The error following this error is the RDF error return.

**REQUESTID**

request ID is !@UL

**Explanation:**

The number is the request ID for the command just queued.

**User Action:**

None

**RESUNDEFINED**

referenced restore(s) !AZ undefined

**Explanation:**

When creating or modifying a valid object, the object's record contains a reference to a restore name that does not exist. One or more of the specified restores may be undefined.

**User Action:**

Check spelling of the restore names and retry, or create the restore objects in the database.

**SAVUNDEFINED**

referenced save(s) !AZ undefined

**Explanation:**

When creating or modifying a valid object, the object's record contains a reference to a save name that does not exist. One or more of the specified saves may be undefined.

**User Action:**

Check spelling of the save names and retry, or create the save objects in the database.

**SCHEDCREATEERR**

failed to create a scheduling job

**Explanation:**

MDMS failed to create a scheduling job.

**User Action:**

Report the incident to Compaq.

**SCHEDDELETEERR**

failed to delete a scheduling job

**Explanation:**

MDMS failed to delete a scheduling job.

**User Action:**

Report the incident to Compaq.

**SCHEDDISCONNECT**

scheduler disconnected from mailbox

**Explanation:**

The scheduler was disconnected from a mailbox

**User Action:**

Report the incident to Compaq.

## MDMS Messages

### **SCHEDDUPJOB**

duplicate scheduler job found

#### **Explanation:**

MDMS found a duplicate scheduling job

#### **User Action:**

Report the incident to Compaq.

### **SCHEDEXTSTATUS**

external schedule job exited with bad status

#### **Explanation:**

An external schedule job exited with bad status

#### **User Action:**

Report the incident to Compaq.

### **SCHEDLOOPERR**

schedule thread terminating with fatal error, restarting

#### **Explanation:**

The MDMS internal schedule thread encountered an error and terminated. The thread is restarted.

#### **User Action:**

Report the problem to Compaq.

### **SCHEDMODIFYERR**

failed to modify a scheduling job

#### **Explanation:**

MDMS failed to modify a scheduling job.

#### **User Action:**

Report the incident to Compaq.

### **SCHEDNOJOBCOMPLETE**

no job complete time was returned from a scheduled job

#### **Explanation:**

No job complete time was returned from a scheduled job.

#### **User Action:**

Report the incident to Compaq.

### **SCHEDNOJOBEXISTS**

no job exists was returned from a scheduled job

#### **Explanation:**

No job exists was returned from a scheduled job.

#### **User Action:**

Report the incident to Compaq.

### **SCHEDNOJOBNUM**

no job number was returned from a scheduled job

**Explanation:**

No job number was returned from a scheduled job.

**User Action:**

Report the incident to Compaq.

**SCHEDNOJOBSTART**

no job start time was returned from a scheduled job

**Explanation:**

No job start time was returned from a scheduled job.

**User Action:**

Report the incident to Compaq.

**SCHEDNOJOBSTATUS**

no job status was returned from a scheduled job

**Explanation:**

No job status was returned from a scheduled job.

**User Action:**

Report the incident to Compaq.

**SCHEDNOSUCHJOB**

failed to find a scheduling job

**Explanation:**

MDMS failed to find a scheduling job.

**User Action:**

Report the incident to Compaq.

**SCHEDSHOWERR**

failed to show a scheduling job

**Explanation:**

MDMS failed to show a scheduling job.

**User Action:**

Report the incident to Compaq.

**SCHEDSYSTEMERR**

failed to access the internal scheduler queue

**Explanation:**

An MDMS call to a system service failed in the scheduler functions.

**User Action:**

Report the incident to Compaq.

**SCHEDULECONFL**

schedule qualifier and novolume qualifier are incompatible

**Explanation:**

The /SCHEDULE and /NOVOLUME qualifiers are incompatible for this command.

## MDMS Messages

### **User Action:**

Use the /SCHEDULE and /VOLSET qualifiers for this command.

### **SCHEDVOLCONFL**

schedule qualifier and volume parameter are incompatible

### **Explanation:**

The /SCHEDULE and the volume parameter are incompatible for this command.

### **User Action:**

Use the /SCHEDULE qualifier and leave the volume parameter blank for this command.

### **SCHEDULECONFL**

schedule qualifier and novolume qualifier are incompatible

### **Explanation:**

The /SCHEDULE and /NOVOLUME qualifiers are incompatible for this command.

### **User Action:**

Use the /SCHEDULE and /VOLSET qualifiers for this command.

### **SCHEDVOLCONFL**

schedule qualifier and volume parameter are incompatible

### **Explanation:**

The /SCHEDULE and the volume parameter are incompatible for this command.

### **User Action:**

Use the /SCHEDULE qualifier and leave the volume parameter blank for this command.

### **SCHUNDEFINED**

referenced schedule(s) !AZ undefined

### **Explanation:**

When creating or modifying a valid object, the object's record contains a reference to a schedule name that does not exist. One or more of the specified schedules may be undefined.

### **User Action:**

Check spelling of the schedule names and retry, or create the schedule objects in the database.

### **SELUNDEFINED**

referenced selection(s) !AZ undefined

### **Explanation:**

When creating or modifying a valid object, the object's record contains a reference to a selection name that does not exist. One or more of the specified selections may be undefined.

### **User Action:**

Check spelling of the selection names and retry, or create the selection objects in the database.

### **SETLOCALEFAIL**

an error occurred when accessing locale information

### **Explanation:**

When executing the SETLOCALE function an error occurred.

**User Action:**

A user should not see this error.

**SETPROTECTED**

protected field(s) set, verify consistency

**Explanation:**

You have directly set a protected field with this command. Normally these fields are maintained by MDMS. This has the potential to make the database inconsistent and cause other operations to fail.

**User Action:**

Do a SHOW /FULL on the object(s) you have just modified and verify that your modifications leave the object(s) in a consistent state.

**SLSDBINUSE**

SLS\$DB network object in use

**Explanation:**

The MDMS server could not be started because it could not declare the network task SLS\$DB. The network task SLS\$DB is already in use.

**User Action:**

Check the server's logfile for more information. Check the logical MDMS\$\$SUPPORT\_PRE\_V3 in the system table. If this is TRUE and the SLS\$TAPMGRDB process is running the server cannot be started. Shut down the SLS\$TAPMGRDB process by shutting down SLS. Restart MDMSV3.0 server and then restart SLS.

**SNDMAILFAIL**

send mail failed, see log file for more explanation

**Explanation:**

While sending mail during the scheduled activities, a call to the mail utility failed.

**User Action:**

Check the log file for the failure code from the mail utility.

**SOMESUCCESS**

some objects in list were not processed

**Explanation:**

The request was partially successful, but some of the objects were not processed as shown in the extended status.

**User Action:**

Examine the extended status, and retry command as needed.

**SPAWNCMDBUFOVR**

spawn command buffer overflow

**Explanation:**

During the mount of a volume, the spawned mount command was too long for the buffer. This is an internal error.

## MDMS Messages

### **User Action:**

Provide copies of the MDMS command issued, the database files and the server's logfile for further analysis.

### **SVRBUGCHECK**

internal inconsistency in SERVER

### **Explanation:**

The MDMS server software (MDMS\$SERVER.EXE) detected an inconsistency. This is an internal error.

### **User Action:**

Provide copies of the MDMS command issued, the database files and the server's logfile for further analysis. Restart the server.

### **SVRDISCON**

server disconnected

### **Explanation:**

The server disconnected from the request because of a server problem or a network problem.

### **User Action:**

Check the server's logfile and file SYSS\$MANAGER:MDMS\$SERVER.LOG for more information. Provide copies of the MDMS command issued, the database files and the server's logfile for further analysis.

### **SVREXIT**

server exited

### **Explanation:**

Server exited. Check the server logfile for more information.

### **User Action:**

Depends on information in the logfile.

### **SVRLOGERR**

server logged error

### **Explanation:**

The server failed to execute the request. Additional information is in the server's logfile.

### **User Action:**

Depends on information in the logfile.

### **SVRRUN**

server already running

### **Explanation:**

The MDMS server is already running.

### **User Action:**

Use the MDMS\$SHUTDOWN procedure with parameter RESTART to restart the server.

### **SVRSTART**

Server !AZ!UL.!UL-!UL started



**Explanation:**

The server has started up identifying its version and build number.

**User Action:**

None.

**SVRSTARTSTRING**

Server !AZ started

**Explanation:**

The server has started up identifying its version and build number.

**User Action:**

None.

**SVRTERM**

Server terminated abnormally

**Explanation:**

The MDMS server was shut down. This could be caused by a normal user shutdown or it could be caused by an internal error.

**User Action:**

Check the server's logfile for more information. If the logfile indicates an error has caused the server to shut down then provide copies of the MDMS command issued, the database files and the server's logfile for further analysis.

**SVRUNEXP**

unexpected error in SERVER !AZ line !UL

**Explanation:**

The server software detected an internal inconsistency.

**User Action:**

Provide copies of the MDMS command issued, the database files and the server's logfile for further analysis.

**TCPIPLISEXIT**

TCP/IP listener exited

**Explanation:**

The TCP/IP listener has exited due to an internal error condition or because the user has disabled the TCPIP transport for this node. The TCP/IP listener is the server's routine to receive requests via TCP/IP.

**User Action:**

The TCP/IP listener should be automatically restarted unless the TCPIP transport has been disabled for this node. Provide copies of the MDMS command issued, the database files and the server's logfile for further analysis if the transport has not been disabled by the user.

**TCPIPLISRUN**

listening on TCP/IP node !AZ port !AZ

**Explanation:**

The server has successfully started a TCP/IP listener. Requests can now be sent to the server via TCP/IP.

## MDMS Messages

### **User Action:**

None.

### **TOOLARGE**

entry is too large

### **Explanation:**

Either entries cannot be added to a list of an MDMS object or existing entries cannot be renamed because the maximum list size would be exceeded.

### **User Action:**

Remove other elements from list and try again.

### **TOOMANY**

too many objects generated

### **Explanation:**

You attempted to perform an operation that generated too many objects.

### **User Action:**

There is a limit of 1000 objects that may be specified in any volume range, slot range or space range. Re-enter command with a valid range.

### **TOOMANYSELECTS**

too many selections for a field, use only one

### **Explanation:**

More than one selection was specified for a particular field.

### **User Action:**

Specify only one field to select on.

### **TOOMANYSORTS**

too many sort qualifiers, use only one

### **Explanation:**

When specify more than one field to sort on.

### **User Action:**

Specify only one field to sort on.

### **UNDEFINEDREFS**

success, but object references undefined objects

### **Explanation:**

The command was successful, but the object being created or modified has references to undefined objects. Subsequent messages indicate which objects are undefined.

### **User Action:**

This allows objects to be created in any order, but some operations may not succeed until the objects are defined. Verify/correct the spelling of the undefined objects or create the objects if needed.

### **UNKVOLENT**

unknown volume !AZ entered in jukebox !AZ

**Explanation:**

A volume unknown to MDMS has been entered into a jukebox.

**User Action:**

Use the INVENTORY command to make the volume known to MDMS or use a jukebox utility program (CARTRIDGE or MRU) to eject the volume from the jukebox.

**UNSUPPORTED**

unsupported function

**Explanation:**

You attempted to perform an unsupported function.

**User Action:**

None.

**UNSUPPORTED1**

unsupported function !AZ

**Explanation:**

You attempted to perform an unsupported function.

**User Action:**

None.

**UNSUPRECVER**

unsupported version for record !AZ in database !AZ

**Explanation:**

The server has detected unsupported records in a database file. These records will be ignored.

**User Action:**

Consult the documentation about possible conversion procedures provided for this version of MDMS.

**USERNOTAUTH**

user is not authorized for volume pool

**Explanation:**

When allocating a volume, you specified a pool for which you are not authorized.

**User Action:**

Specify a pool for which you are authorized, or add your name to the list of authorized users for the pool. Make sure the authorized user includes the node name or group name in the pool object.

**VISIONCONFL**

vision option and volume parameter are incompatible

**Explanation:**

You attempted to create volumes with the vision option and the volume parameter. This is not supported.

## MDMS Messages

### **User Action:**

The vision option is used to create volumes with the volume identifiers read by the vision system on a jukebox. Re-enter the command with either the vision option (specifying jukebox and slot range), or with volume identifier(s), but not both.

### **VOLALRALLOC**

specified volume is already allocated

### **Explanation:**

You attempted to allocate a volume that is already allocated.

### **User Action:**

Use another volume.

### **VOLALRINIT**

volume is already initialized and contains data

### **Explanation:**

When initializing a volume, MDMS detected that the volume is already initialized and contains data.

### **User Action:**

If you are sure you still want to initialize the volume, re-enter the command with the overwrite option.

### **VOLIDICM**

volume ID code missing

### **Explanation:**

The volume ID is missing in a request.

### **User Action:**

Provide volume ID and retry request.

### **VOLINDRV**

volume is currently in a drive

### **Explanation:**

When allocating a volume, the volume is either moving or in a drive, and nopreferred was specified.

### **User Action:**

Wait for the volume to be moved or unloaded, or use the preferred option.

### **VOLINJUKE**

volume is in a jukebox

### **Explanation:**

You attempted load a volume that is currently in a jukebox into a drive that is not in the jukebox.

### **User Action:**

Load the volume into a drive within the current jukebox, or check the jukebox name for the drive.

### **VOLINSET**

volume is already bound to a volume set

**Explanation:**

You cannot bind this volume because it is already in a volume set and is not the first volume in the set.

**User Action:**

Use another volume, or specify the first volume in the volume set.

**VOLLOST**

volume location is unknown

**Explanation:**

The volume's location is unknown.

**User Action:**

Check if the volume's placement is in a magazine, and if so if the magazine is defined. If not, create the magazine. Also check the magazine's placement.

**VOLMOVE**

volume cannot be loaded but can be moved to jukebox or drive

**Explanation:**

The volume is not currently in a placement where it can be loaded, but can be moved there.

**User Action:**

Move the volume to the drive, or use the automatic move option on the load and retry.

**VOLMOVING**

volume is currently being moved

**Explanation:**

In a move, load or unload command, the specified volume is already being moved.

**User Action:**

Wait for volume to come to a stable placement and retry. If the volume is stuck in the moving placement, check for an outstanding request and cancel it. If all else fails, manually change volume state.

**VOLNOTALLOC**

specified volume is not allocated

**Explanation:**

You attempted to bind or deallocate a volume that is not allocated.

**User Action:**

None for deallocate. For bind, allocate the volume and then bind it to the set, or use another volume.

**VOLNOTBOUND**

volume is not bound to a volume set

**Explanation:**

You attempted to unbind a volume that is not in a volume set.

**User Action:**

None.

## MDMS Messages

### **VOLNOTINACS**

one or more volumes are not in this ACS

#### **Explanation:**

One or more volumes for the command are not in this ACS.

#### **User Action:**

Verify that all volumes are in the same ACS and that the ACS id is correct.

### **VOLNOTINJUKE**

volume is not in a jukebox

#### **Explanation:**

When loading a volume into a drive, the volume is not in a jukebox.

#### **User Action:**

Use the move option and retry the load. This will issue OPCOM messages to move the volume into the jukebox.

### **VOLNOTINPOOL**

loaded volume is not in the specified pool

#### **Explanation:**

During a scratch load of a volume in a drive, the volume loaded was not in the requested pool.

#### **User Action:**

Load another volume that is in the requested pool. A recommended volume is printed in the OPCOM message. Note that if no pool was specified, the volume must have no pool defined.

### **VOLNOTLOADED**

the volume is not loaded in a drive

#### **Explanation:**

On an unload request, the volume is not recorded as loaded in a drive.

#### **User Action:**

If the volume is not in a drive, none. If it is, issue an unload drive command to unload it.

### **VOLONOTHDRV**

volume is currently in another drive

#### **Explanation:**

When loading a volume, the volume was found in another drive.

#### **User Action:**

Wait for the volume to be unloaded, or unload the volume and retry.

### **VOLSALLOC**

!AZ volumes were successfully allocated

#### **Explanation:**

When attempting to allocate multiple volumes using the quantity option, some but not all of the requested quantity of volumes were allocated.

#### **User Action:**

See accompanying message as to why not all volumes were allocated.

**VOLSDRIVES**

one or more of the volumes are in drives or are moving

**Explanation:**

One or more of the volumes in the move request are in drives and cannot be moved. A show volume /brief will identify which volumes are in drives.

**User Action:**

Unload the volume(s) in drives and retry, or retry without specifying the volumes in drives.

**VOLUMEEXISTS**

specified volume(s) already exist

**Explanation:**

The specified volume or volumes already exist and cannot be created.

**User Action:**

Use a set command to modify the volume(s), or create new volume(s) with different names.

**VOLUNDEFINED**

referenced volume !AZ undefined

**Explanation:**

When creating or modifying a valid object, the object's record contains a reference to a volume ID that does not exist.

**User Action:**

Check spelling of the volume ID and retry, or create the volume object in the database.

**VOLWRTLCK**

volume loaded with hardware write-lock

**Explanation:**

The requested volume was loaded in a drive, but is hardware write-locked when write access was requested.

**User Action:**

If you need to write to the volume, unload it, physically enable it for write, and re-load it.

**WRONGLABEL**

initializing volume !AZ as !AZ is disallowed

**Explanation:**

The label of the volume loaded in the drive for initialization does not match the requested volume label and there is data on the volume. Or initializing the volume with the requested label causes duplicate volumes in the same jukebox or location.

**User Action:**

If you wish to overwrite the volume label, re-issue the command with the overwrite qualifier. If there are duplicate volumes in the same location or jukebox you need to move the other volume from the jukebox or location before retrying.

**WRONGVOLUME**

wrong volume label or unlabelled volume was loaded

## MDMS Messages

### **Explanation:**

On a load volume command, MDMS loaded a volume with the wrong volume label or a blank volume label into the drive.

### **User Action:**

Check the volume, and optionally perform an initialization of the volume and retry. If this message is displayed in an OPCOM message, you will need another free drive to perform the initialization. The volume has been unloaded.



---

## Converting SLS/MDMS V2.X to MDMS V4

### D.1 Converting SLS/MDMS V2.X Symbols and Database

This section describes how to convert the SLS/MDMS V2.X symbols and database to Media, Device and Management Services Version 4 (MDMS). The conversion is automated as much as possible, however, you will need to make some corrections or add attributes to the objects that were not present in SLS/MDMS V2.X.

Before doing the conversion, you should read Chapter 11 - MDMS Configuration in this Guide to Operations to become familiar with configuration requirements.

All phases of the conversion process should be done on the first database node on which you installed MDMS V4. During this process you will go through all phases of the conversion:

1. Convert the symbols in `SYSS$STARTUP:TAPESTART.COM` into the following objects:
  - Locations
  - Domain
  - Nodes
  - Media types
  - Jukeboxes
  - Drives
2. Convert the database authorization file, `VALIDATE.DAT`, into node objects.
  - Convert the rest of the database files:
    - Pool Authorization file (`POOLAUTH.DAT`)
    - Slot Definition file (`SLOTMAST.DAT`)
    - Volume Database file (`TAPEMAST.DAT`)
    - Magazine Database file (`SLS$MAGAZINE_MASTER_FILE.DAT`)

When you install on any other node that does not use the same `TAPESTART.COM` as the database node, you only do the conversion of `TAPESTART.COM`

#### D.1.1 Executing the Conversion Command Procedure

To execute the conversion command procedure, type in the following command:

```
$ @MDMS$SYSTEM:MDMS$CONVERT_V2_TO_V3
```

The command procedure will introduce itself and then ask what parts of the SLS/MDMS V2.x you would like to convert.

## Converting SLS/MDMS V2.X to MDMS V4

### D.1 Converting SLS/MDMS V2.X Symbols and Database

During the conversion, the conversion program will allow you to start and stop the MDMS server. The MDMS server needs to be running when converting TAPESTART.COM and the database authorization file. The MDMS should not be running during the conversion of the other database files.

During the conversion of TAPESTART.COM the conversion program generates the following file:

```
$ MDMS$SYSTEM:MDMS$LOAD_DB_nodename.COM
```

This file contains the MDMS commands to create the objects in the database. You have the choice to execute this command procedure or not during the conversion.

The conversion of the database files are done by reading the SLS/MDMS V2.x database file and creating objects in the MDMS V4 database files.

You must have the SLS/MDMS V2.x DB server shutdown during the conversion process. Use the following command to shut down the SLS/MDMS V2.x DB server:

```
$ @SLS$SYSTEM:SLS$SHUTDOWN
```

#### D.1.2 Resolving Conflicts During the Conversion

Because of the difference between SLS/MDMS V2.x and MDMS V4 there will be conflicts during the conversion. Instead of stopping the conversion program and asking you about each conflict, the conversion program generates the following file during each conversion:

```
$ MDMS$MDMS$LOAD_DB_CONFLICTS_nodename.COM
```

Where nodename is the name of the node you ran the conversion on. This file is not meant to be executed, it is there for you to look at and see what commands executed and caused a change in the database. This change is flagged because there was already an object in the database or this command changed an attribute of the object.

An example could be that you had two media types of the same name but one specified compressed and one other specified non compressed. This would cause a conflict. MDMS V4 does not allow two media types with the same name but different attributes. What you see in the conflict file would be the command that tried to create the same media type. You will have to create a new media type.

Table D–1 shows the symbols in TAPESTART.COM file and what conflicts they may cause.

At the completion of the conversion of the database files, you will see a message that notes the objects that where in an object but not defined in the database. For example: the conversion program found a pool in a volume record that was not a pool object.

**Table D–1 Symbols in TAPESTART.COM**

TAPESTART.COM Symbol	MDMS V4 Attribute or Object	Possible conflict
ALLOCSCRATCH	If defined, adds the SCRATCH_TIME attribute to the domain object.	If the ALLOCSCRATCH symbol is different in different TAPESTART.COM files a line is added to the conflict file.

**Converting SLS/MDMS V2.X to MDMS V4**  
**D.1 Converting SLS/MDMS V2.X Symbols and Database**

**Table D–1 Symbols in TAPESTART.COM**

DB_NODES	If defined, creates a node object for the nodes in the DB_NODES list.	A conflict can be generated if the node exists and an attribute changed with a different TAPESTART.COM file. Every drive and jukebox definition in the TAPESTART.COM can cause a node to be created with a /NODATABASE_SERVER qualifier. A DB node will change the attribute to database server, this can cause a line to be added to the conflict file.
DCSC_n_NODES	If defined, creates a node object and adds the node attribute to the DCSC jukebox.	All adds of nodes to jukeboxes cause a line to be added to the conflict file.
DCSC_DRIVES	If defined, creates a drive object for DCSC.	If an attribute is different when adding attributes a line is added to the conflict file.
DENS_x	If defined, adds the density or compaction attribute to a media type. If the value is COMP or NOCOMP then the compaction attribute is define: YES or NO. If the density is anything other than COMP or NOCOMP then the value is placed in the density attribute.	A line is added to the conflict file if the DENS_x is different.
FRESTA	If defined, adds the deallocate state attribute to the domain object.	If the FRESTA symbol is different in different TAPESTART.COM files a line is added to the conflict file.
LOC	Creates a location object and also sets the ONSITE_LOCATION attribute in domain object.	If the object exists or is different than the onsite location attribute in the domain object a line to be added to the conflict file. This can happen when you have different LOC symbol in two TAPESTART.COM files.
MAXSCRATCH	If defined, adds the maximum scratch time attribute to the domain object.	If the MAXSCRATCH symbol is different in different TAPESTART.COM files a line is added to the conflict file.
MTYPE_x	Creates a media type object for each MTYPE_x.	A line is added to the conflict file if a media type is already in the database and another one has the same name. In SLS/MDMS V2.x you could have the same media type name with compaction and nocompaction. In MDMS you cannot have two media types with the same name. You need to change the name of one of the media type and enter it into the database. You will also have to change ABS or HSM to reflect this. Also, you may have to change volume and drive objects.

**Converting SLS/MDMS V2.X to MDMS V4**  
**D.1 Converting SLS/MDMS V2.X Symbols and Database**

**Table D-1 Symbols in TAPESTART.COM**

NET_REQUEST_TIMEOUT	If defined, adds the NETWORK_TIMEOUT attribute to the domain object.	If the NET_REQUEST_TIMEOUT is different in different TAPESTART.COM files a line is added to the conflict file.
PROTECTION	Adds the default protection to the domain object.	A line is added to the conflict file if the protection is changed.
QUICKLOAD	When drives are created, this attribute is added as automatic reply.	A line is added to the conflict file if a drive's automatic reply is changed.
TAPE_JUKEBOXES	Creates a jukebox object for each jukebox in the list.	A line is added to the conflict file if a jukebox is already defined and any of the attributes change.
TAPEPURGE_MAIL	If defined, adds the mail attribute to the domain object.	If the TAPEPURGE_MAIL is different in different TAPESTART.COM files a line is added to the conflict file.
TOPERS	If defined, adds the Opcom class attribute to the domain object.	If the TOPERS symbol is different in different TAPESTART.COM files a line is added to the conflict file.
TRANS_AGE	If defined, adds the transition time attribute to the domain object.	If the TRANS_AGE symbol is different in different TAPESTART.COM files a line is added to the conflict file.
VLT	Creates a location object and also sets the OFFSITE_LOCATION attribute in domain object.	If the object exists or is different than the offsite location attribute in the domain object, a line is added to the conflict file. This can happen when you have different VLT symbol in two TAPESTART.COM files.

## D.2 Things to Look for After the Conversion

Because of the differences between SLS/MDMS V2.x and MDMS V4 you should go through the objects and check the attributes and make sure that the objects have the attributes that you want. Table D–2 shows the attributes of objects that you may want to check after the conversion.

**Table D–2 Things to Look for After the Conversion**

Object	Attribute	Description
Drive	Drive	Make sure you have all of the drives defined. In the MDMS V4 domain, you can only have one drive with a given name. In SLS/MDMS V2.x you could have two drives with the same name if they were in different TAPESTART.COM files. You should make sure that all drives in your domain are in the database. You may have to create one drive with a name of say, DRIVE1 with a device name of \$1\$MUA520 and a node of NODE1. Then create another drive, DRIVE2, with a device name of \$1\$MUA520 and a node of NODE2.  A line is added to the conflict file every time a node is added to a drive. This flags you to check that the node really belongs to this drive or if you need to create another drive.
	Description	Make sure this is the description you want for this drive. This attribute is not filled in during the conversion program.
	Device	Make sure this device name does not have a node name as part of it.
	Nodes	Make sure this list of nodes contains the nodes that can reach this drive.
	Disabled	The conversion program enables all drives. If you want this drive disabled, then set this attribute to YES.
	Shared	The conversion program sets this attribute to NO. NO means that MDMS does not have to compete with other applications for this device. If MDMS is supposed to share this device with other applications set this attribute to YES.
	State	Make sure this drive is in the right state. If the drive is not in the right state, you can set this attribute to the right state or issue the following command: \$ MDMS SET DRIVE drive/CHECK
	Automatic reply	The conversion program sets this attribute from the QUICK-LOAD symbol. Make sure this is the way you want the drive to react.
	RW media types	The conversion program added media types to this drive as it found them. Make sure these are the correct read-write media types for this drive.
	RO Media Types	There are no read-only media types in SLS/MDMS V2.x so none is added to the drives during conversion. You may want to add some read-only media types to the drive object.
	Access	The conversion program has no way of knowing what the access should be, therefore, it sets the access attribute to ALL. Make sure this is the access you want for this drive.
	Jukebox	Make sure this is the jukebox that this drive is in.

## Converting SLS/MDMS V2.X to MDMS V4

### D.2 Things to Look for After the Conversion

**Table D–2 Things to Look for After the Conversion**

	Drive Number	Make sure this is the drive number for robot commands.
Domain	Description	Make sure this is the description you want for your domain. The default is: Default MDMS Domain.
	Mail	Make sure this is where you want mail sent when a volume reaches its scratch data and MDMS dellocates it. If you do not want mail sent, make the value blank. The default is: SYSTEM.
	Offsite location	Make sure this is the offsite location that you want for the default when you create objects. This was set to the value of VLT from TAPESTART.COM file. This could be different in each TAPESTART.COM file.
	Onsite location	Make sure this is the onsite location that you want for the default when you create objects.
	Default media type	Make sure this is the media type you want assigned to volumes that you do not specify a media type for, while creating.
	Deallocate state	Make sure this is the default state you want volumes to go to after they have reached their scratch date. This could be changed each time that you convert the TAPESTART.COM file on a new node.
	Opcom classes	Make sure these are the Opcom classes where you want MDMS OPCOM messages directed. This could be changed each time you convert the TAPESTART.COM file on a new node.
	Protection	Make sure this is the default protection that you want assigned to volumes that you do not specify a protection for.
	Maximum scratch time	Make sure this is the default maximum scratch time you want for volumes in your domain. This could be changed each time that you convert the TAPESTART.COM file on a new node.
	Scratch time	Make sure this is the default scratch time you want for volumes in your domain. This could be changed each time that you convert the TAPESTART.COM file on a new node.
	Transition time	Make sure this is the default transition time you want for volumes in your domain. This could be changed each time that you convert the TAPESTART.COM file on a new node.
	Network time-out	Make sure this is the network timeout you want. This could be changed each time that you convert the TAPESTART.COM file on a new node.
Location	Description	Make sure this is the description you want for this location. This attribute is not filled in during the conversion program.
	Spaces	The conversion program cannot fill in spaces so make sure you set the spaces attribute.
	In location	The conversion program cannot fill in this attribute so make sure if this location is in a higher level location you set this attribute.

## Converting SLS/MDMS V2.X to MDMS V4 D.2 Things to Look for After the Conversion

**Table D–2 Things to Look for After the Conversion**

Media type	Media type	Make sure you have all the media types that you had before. In the MDMS V4 you can only have on media type with the same name. If you had two media types in SLS/MDMS V2.x with the same name, the second one is not created in the MDMS V4 database.
	Description	The conversion program does not add a description to this attribute. Type in a description for this attribute.
	Density	The density attribute is only changed when the DENS_x symbol in the TAPESTART.COM file is something other than COMP or NOCOMP. Check to make sure this is correct.
	Compaction	This attribute is set to YES if the DENS_x symbol in the TAPESTART.COM file is COMP. It is set to NO if the symbol is NOCOMP. Check to make sure this is right.
	Capacity	This attribute is set to the value of DENS_X from the TAPESTART.COM file if it is not defined as COMP or NOCOMP. Check to make sure this right.
Jukebox	Description	The conversion program does not put a description for this attribute. Type in a description to this attribute.
	Nodes	Make sure this list of nodes contains the nodes that can reach the robot.
	Location	Make sure this is the location where this jukebox is located.
	Disabled	The conversion program enables all jukeboxes. If you want this jukebox disabled, set this attribute to YES.
	Shared	The conversion program sets this attribute to NO. NO means that MDMS does not expect to compete with other applications for this jukebox. If MDMS is supposed to share this jukebox with other applications set this attribute to YES.
	Auto reply	The conversion program sets this attribute to NO. Make sure this is the way you want the jukebox to react.
	Access	The conversion program has no way of knowing what the access should be, therefore, it sets the access attribute to ALL. Make sure this is the access you want for this jukebox.
	Control	Make sure that the attribute is set to MRD if MRD controls the robot. If the robot is controlled by DCSC, this attribute should be set to DCSC.
	Robot	Make sure this is the robot for this jukebox.
	Slot count	You need to set the slot count. The conversion program has no way of finding out the slot count.
	Usage	Make sure the usage is correct for the type of jukebox you have. The conversion program has no way of finding out if the jukebox uses magazines or not. If this jukebox uses magazines, you will need to configure it.
Magazine	Description	The conversion program does not add a description to this attribute. Type a description for this attribute.
	Offsite location	The old magazine record had no offsite location, so you need to add this attribute.

## Converting SLS/MDMS V2.X to MDMS V4

### D.2 Things to Look for After the Conversion

**Table D–2 Things to Look for After the Conversion**

	Offsite date	The old magazine record had no offsite date, so you need to add this attribute.
	Onsite location	The old magazine record had no onsite location, so you need to add this attribute.
	Offsite date	The old magazine record had no onsite date, so you need to add this attribute.
Node	Description	The conversion program does not put a description in this attribute. Type a description for this attribute.
	DECnet-Plus fullname	TAPESTART.COM does not support DECnet-Plus, therefore the conversion program cannot put in the DECnet-Plus fullname attribute. If this node uses DECnet-Plus, you should set this attribute.
	TCP/IP fullname	TAPESTART.COM does not support TCP/IP, therefore the conversion program cannot put in the TCP/IP fullname attribute. If this node uses TCP/IP, you should set this attribute.
	Disabled	The conversion program sets the enabled attribute. Make sure you want this node enabled.
	Database server	If this attribute is set to YES, this node has the potential to become a database server. The logical MDMS\$DATABASE_SERVERS must have this node name in its definition of nodes in the domain. This definition is defined in the SYS\$STARTUP:MDMS\$SYSTAR-TUP.COM file
	Location	Make sure this is the location that this node is located in. During the conversion it could have been changed depending on the TAPESTART.COM file or what the default was in the domain object at the time of creation.
	Opcom classes	This attribute is defined as the Opcom class in the domain object when the node was created. Make sure this is the Opcom class for this node.
	Transports	Make sure this is the transport you want. The conversion program has no way of knowing the transports you want so it takes the defaults.
POOL	Description	Make sure this is the description you want for this pool. This attribute is not filled in during the conversion program.
	Authorized users	Make sure that the comma separated list contains all of the authorized users for the pool. The users must be specified as NODE::user
	Default users	You need to set this attribute because conversion program does not set this attribute. The users must be specified as node::user.
VOLUME		The conversion program fills in all needed attributes from the old record.  This is included so you will not think the volume object was forgotten.



## **D.3 Using SLS/MDMS V2.x Clients With the MDMS V4 Database**

This section describes how older versions of SLS/MDMS can coexist with the new version of MDMS for the purpose of upgrading your MDMS domain. You may have versions of ABS, or HSM or SLS which are using SLS/MDMS V2 and which cannot be upgraded or replaced immediately. MDMS V4 provides limited support for older SLS/MDMS clients to make upgrading your MDMS domain to the new version as smooth as possible. This limited support allows rolling upgrade of all SLS/MDMS V2 nodes to MDMS V4. Also ABS and HSM version 3.0 and later have been modified to support either SLS/MDMS V2 or MDMS V2 to make it easy to switch over to the new MDMS. The upgrade procedure has been completed as soon as all nodes in your domain are running the new MDMS V4 version exclusively.

### **D.3.1 Limited Support for SLS/MDMS V2 during Rolling Upgrade**

The major difference between SLS/MDMS V2 and MDMS V4 is the way information about objects and configuration is stored. To support the old version the new server can be set up to accept requests for DECnet object SLS\$DB which was serving the database before. Any database request sent to SLS\$DB will be executed and data returned compatible with old database client requests. This allows SLS/MDMS V2 database clients to still send their database requests to the new server without any change.

The SLS\$DB function in the new MDMS serves and shares information for the following objects to a V2 database client:

- Volume information - previously stored in TAPEMAST.DAT
- Pool information - previously stored in POOLMAST.DAT
- Magazine information - previously stored in MAGAZINE.DAT
- Object information - not shared between the old and new MDMS:
- Drive information - previously stored in TAPESTART.COM
- Jukebox information - previously stored in TAPESTART.COM
- Media type information - previously stored in TAPESTART.COM
- Slot information - previously stored in SLOTMAST.DAT
- Node information - previously stored in NODE\_VALIDATE.DAT

The new MDMS server keeps all its information in a per object database. The MDMS V4 installation process propagates definitions of the objects from the old database to the new V4 database. However, any changes made after the installation of V4 have to be carefully entered by the user in the old and new databases. Operational problems are possible if the databases diverge. Therefore it is recommended to complete the upgrade process as quickly as possible.

### **D.3.2 Upgrading the Domain to MDMS V4**

Upgrading your SLS/MDMS V2 domain starts with the nodes, which have been defined as database servers in symbol DB\_NODES in file TAPESTART.COM. Refer to the Installation Guide for details on how to perform the following steps.

- Step 1. Shut down all SLS/MDMS database servers in your SLS/MDMS domain.
- Step 2. Install version MDMS V4 on nodes, which have been acting as database servers before.
- Step 3. When the new servers are up-and-running check and possibly change the configuration and database entries so that it matches your previous SLS/MDMS V2 setup
- Step 4. Edit SYS\$MANAGER:MDMS\$SYSTARTUP.COM and make sure that:

## Converting SLS/MDMS V2.X to MDMS V4

### D.3 Using SLS/MDMS V2.x Clients With the MDMS V4 Database

- Logical name MDMS\$DATABASE\_SERVERS include this nodes DECnet (Phase IV) node name
- Logical name MDMS\$PREV3\_SUPPORT is set to TRUE to enable the SLS/MDMS V2 support function in the new server
- Logical name MDMS\$VERSION3 is set to TRUE to direct ABS and/or HSM to use the new MDMS V4 interface

If you had to change any of the logical name settings above you have to restart the server using '@SYSS\$STARTUP:MDMS\$STARTUP RESTART'. You can type the server's logfile to verify that the DECnet listener for object SLS\$DB has been successfully started.

Step 5. To support load, unload and operator requests from old SLS/MDMS clients you have to edit SYSS\$MANAGER:TAPESTART.COM and change the line which defines DB\_NODES to read like this:

```
§ DB_NODES = ""
```

This prevents a SLS/MDMS V2 server from starting the old database server process SLS\$TAPMGRDB.

Step 6. Start SLS/MDMS V2 with @SYSS\$STARTUP:SLS\$STARTUP.

Use a "STORAGE VOLUME" command to test that you can access the new MDMS V4 database.

Step 7. Now you are ready to start up ABS, HSM or SLS.

Note that no change is necessary for nodes running SLS/MDMS V2 as a database client. For any old SLS/MDMS client in your domain you have to add its node object to the MDMS V4 database. In V4 all nodes of an MDMS domain have to be registered (see command MDMS CREATE NODE). These clients can connect to a new MDMS DB server as soon as the new server is up and running and has been added to the new database.

A node with either local tape drives or local jukeboxes which are accessed from new MDMS V4 servers need to have MDMS V4 installed and running.

A node with either local tape drives or local jukeboxes, which are accessed from old SLS/MDMS V2 servers, need to have SLS/MDMS V4 running.

If access is required from both old and new servers then both versions need to be started on that node. But in all cases DB\_NODES in all TAPESTART.COM needs to be empty.

#### D.3.3 Reverting to SLS/MDMS V2

MDMS V4 allows you to convert the MDMS V4 volume database back to the SLS/MDMS V2 TAPEMAST.DAT file. Any changes you did under MDMS V4 for pool and magazine objects need to be entered manually into V2 database. Any changes you did under MDMS V4 for drive, jukebox or media type objects need to be updated in file TAPESTART.COM.

The following steps need to be performed to revert back to a SLS/MDMS V2 only domain:

- Step 1. Shut down all applications using MDMS (i.e., ABS, HSM and SLS)
- Step 2. Shut down all MDMS V4 servers in the domain and deassign system logical name MDMS\$VERSION3 on all nodes.
- Step 3. .Convert the new database back to the old database files. Refer to section "Converting SLS/MDMS V2 Symbols and Database" for instructions.
- Step 4. Edit TAPESTART.COM on all SLS/MDMS nodes, which should be database servers again. Add the node's DECnet name to the symbol DB\_NODES.

## Converting SLS/MDMS V2.X to MDMS V4

### D.4 Convert from MDMS Version 3 to a V2.X Volume Database

- Step 5. Remove the call to MDMS\$STARTUP.COM from your SYSTARTUP\_VMS.COM.
- Step 6. Make sure a call to SLS\$STARTUP.COM is included in your SYSTARTUP\_VMS.COM.
- Step 7. Start up SLS/MDMS V2 and all applications using it.

#### D.3.4 Restrictions

During the rolling upgrade period, the following restrictions apply:

- Only the first media type of a volume object can be used by a SLS/MDMS V2 client.
- Node names must be exactly the nodes' DECnet (Phase IV) names.
- Some functions of old V2 utilities will not work. All updates to pools, slots, magazines and volumes should be performed on a MDMS V4 node.

### D.4 Convert from MDMS Version 3 to a V2.X Volume Database

This section describes how to convert the MDMS V4 volume database back to a SLS/MDMS V2.X volume database.

If for some reason, you need to convert back to SLS/MDMS V2.X a conversion command procedure is provided. This conversion procedure does not convert anything other than the volume database. If you have added new objects, you will have to add these to TAPESTART.COM or to the following SLS/MDMS V2.X database files:

- database authorization file (VALIDATE.DAT)
- Pool Authorization file (POOLAUTH.DAT)
- Slot Definition file (SLOTMAST.DAT)
- Volume Database file (TAPEMAST.DAT)
- Magazine Database file (SLS\$MAGAZINE\_MASTER\_FILE.DAT)

To execute the conversion command procedure, type in the following command:

```
$ @MDMS$SYSTEM:MDMS$CONVERT_V3_TO_V2
```

After introductory information, this command procedure will ask you questions to complete the conversion.



---

# Index

## A

---

Access control lists (ACLs) 5-8  
Access Security 1-8  
Activity logging 5-1  
ANALYZE Command 5-26  
Application and User Performance Impeded 5-19  
Archive Class  
    definition 1-4  
Archive class 5-13  
    create 5-24  
    multiple 5-10  
    repack 5-23  
    replace 5-26  
    reshelve 5-13  
    same in plus mode as basic 5-39  
Audit logging 5-33

## B

---

Backup  
    considerations 5-10  
    consolidated 5-28  
    critical files 5-9  
    image 5-9  
    incremental 5-9  
    nightly 5-30  
    online cache data 5-11  
    shelved data 5-10  
    shelved files 5-10  
    strategy 5-11  
    using OpenVMS 5-12  
    via shelving 5-28  
    with HSM 5-29  
    with multiple archive classes 5-10  
Basic Mode  
    Converting to Plus Mode 5-37

## C

---

Cache 1-7  
    advantages 1-8  
    exceeding cache capacity 1-10  
    flushing 1-10, 5-11  
    HSM Processes 1-9  
    Magneto-Optical device 1-9  
    Preshelving 1-9  
    shelving 1-9

    Unshelving 1-9  
        usage 5-32  
Cancelling requests 5-37  
Capacity 5-15  
Capacity latitude 5-15  
Catalog 5-21  
    analysis 5-26  
    definition 1-10  
    managing 5-21  
    recovering 5-13  
    repair 5-26  
Checkpoint  
    for Basic to Plus mode 5-37  
CHECKPOINT command 5-12  
Consolidated Backup 5-1  
Converting Basic to Plus 5-1  
Copying shelved files 5-2  
Creating new archive classes 5-25  
creating new archive classes 5-25  
critical files 5-4

## D

---

Data  
    critical files 5-9  
    safety 5-10  
Device  
    dismounting 5-2  
DFS 5-6  
    access 5-6  
Directory files 5-29  
Dismounting Disks 5-2

## E

---

Event logging  
    capabilities 5-33  
    reinitialize 5-34  
    types 5-33  
Example  
    ANALYZE Command with Default Confirmation  
        5-26  
    ANALYZE/REPAIR/CONFIRM 5-27  
    ANALYZE/REPAIR/CONFIRM/OUTPUT 5-27  
    Mode Conversion 5-39  
    Policy Audit Log Entry 5-35  
    Shelf Handler Audit Log Entry 5-35  
    Shelf Handler Error Log Entry 5-35

## F

---

File

- file header limit 5-33
- File header
  - back up 5-10
- Files
  - contiguous 5-6
  - critical HSM files 5-5
  - Critical HSM product files 5-4
  - extending the index File 5-33
  - frequent reactive shelving requests 5-18
  - HSM\$PEP\_AUDIT.LOG 5-34
  - HSM\$PEP\_ERROR.LOG 5-34
  - HSM\$SHP\_AUDIT.LOG 5-34
  - HSM\$SHP\_ERROR.LOG 5-34
  - not Shelved 5-6
  - placed files 5-9
  - policy audit log 5-34
  - policy error log 5-34
  - preshelved 5-4
  - recovering boot-up files 5-13
  - recovering critical files 5-5
  - recovering the HSM\$UID file 5-13
  - restoring 5-31
  - shelf handler audit log 5-34
  - shelf handler error log 5-34
  - should not be preshelved 5-32
  - that will not be preshelved 5-30

## H

---

- High water mark 5-15
- HSM
  - catalog 5-21
  - data safety 5-25
  - managing the environment 5-1
  - recovering the database 5-13
- HSM Basic
  - convert to Plus mode 5-38
- HSM Plus
  - convert from Basic 5-38
- HSM policy model 5-13
- HSM\$MANAGER directory 5-25

## I

---

- Image backup 5-9
- Incremental backup 5-9

## L

---

- Large files 5-6
- Latitude, storage capacity 5-14
- Log files 5-34

- accessing 5-34
- activity logs 5-36
- event logs 5-36
- policy audit log 5-35
- shelf handler audit log 5-36
- shelf handler error log 5-34
- Logical Names
  - for NFS 5-8
  - for PATHWORKS 5-8
- Low water mark 5-15

## M

---

- Managing HSM environment
  - access control lists 5-8
  - Backing up critical files 5-9
  - backing up critical files 5-9
  - backing up online cache 5-9
  - backup strategies 5-1
  - cache flushing 5-37
  - cache usage 5-1
  - canceling policy requests 5-37
  - catalog analysis and repair 5-1
  - catalogs 5-4
  - consolidated backup 5-28
  - contiguous and placed files 5-9
  - converting from Basic mode to Plus mode 5-37
  - copying shelved files 5-1
  - critical HSM product files 5-4
  - disable shelving 5-5
  - dismounting disks 5-1
  - enable facility for shelving/unshelving 5-39
  - ensuring data safety 5-1
  - entering MDMS information 5-38
  - extending the index file 5-33
  - files never shelved/preshelved 5-6
  - finding lost user data 5-11
  - image backup 5-12
  - incremental backup 5-12
  - Maintaining file headers limit 5-33
  - maintaining shelving policies 5-13
  - multiple archive classes 5-10
  - nightly backups 5-30
  - offsite storage 5-12
  - OpenVMS BACKUP 5-13
  - protecting system files from shelving 5-1, 5-4
  - ranking policy execution 5-20
  - recommendations 5-32
  - recover boot-up files 5-13
  - recovering data from a lost shelved file 5-12
  - recovering the HSM\$UID files 5-12
  - renaming disks 5-1

- repacking archive classes 5-23
- replacing a lost or damaged shelf volume 5-25
- Restarting the Shelf Handler 5-38
- restore individual files 5-31
- restoring critical files 5-5
- restoring files to another disk 5-1
- Restoring Volumes 5-31
- shutting down the shelf handler 5-38
- system files and disks 5-5
- Using OpenVMS BACKUP 5-9
- using SMU LOCATE 5-11

Maximum capacity 5-14

MDMS

- entering appropriate information 5-38

Modify file headers 1-4

Multiple archive classes 5-10

## N

---

NFS 5-1

- access 5-6

- file faults 5-6

- Logical Names 5-8

## O

---

Operating efficiency 5-15

## P

---

PATHWORKS 5-1

- access 5-6, 5-8

- file faults 5-7

- logical names 5-8

Performance Impeded 5-19

Policy

- audit log 5-34

- concepts 5-14

- creating 5-15

- error logs 5-23

- high water mark 5-16

- implementing a balance 5-16

- low water mark 5-18

- maximum capacity 5-14

- model 5-15, 5-16

- ranking execution 5-20

- reactive 5-18

- shelving process 5-15

- situations 5-16

- volume occupancy 5-16

## R

---

Recovering

- boot-up files 5-13

- critical files 5-5

- HSM catalogs 5-12

- HSM database 5-12

- user data 5-12

Reinitializing log files 5-34

Renaming Disks 5-3

Repack

- archive class 5-23

- archive classes 5-23

Repair catalog 5-27

Replacing

- archive classes 5-1

- lost or damaged shelf volume 5-1

replacing a lost/damaged shelf volume 5-25

Restoring

- disks and files 5-29

- volumes 5-31

Restoring files to a different/new disk 5-4

## S

---

Shelf handler

- audit log 5-35

- error log 5-35

- restart 5-38

- shutdown 5-38

Shelved files

- access control lists 5-8

- copying 5-1

Shelving

- catalog 5-11

- disable 5-38

- goal not reached 5-17

- maintaining policies 5-13

Site disaster 5-26

SLS

- SBK files 5-29

- set up 5-29

SMU CHECKPOINT command 5-11, 5-39

Split-merge

- operation 5-23

- request disposition 5-23

System disk/file 5-5

System files

- protection from shelving 5-1

System operating efficiency 5-15